

# Operation guide[PuduBot2]

## Download

To download the PDF version of this document, please click here:

[PuduBot2\\_Operation\\_Guide\\_V12.2-231117.pdf](#)

## Quick Start Guide

### Power on

Step 1 Make sure that the master switch has been turned to the "I" position before starting up the robot.

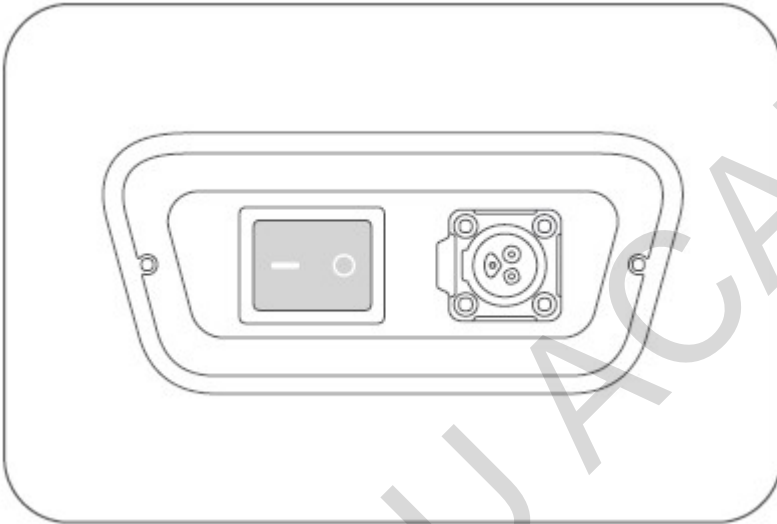

Step 2 Move the robot to the startup location. Press and hold the power switch for 1 second, and the light strip on the top of the robot will turn blue, indicating that the robot has been successfully powered on.

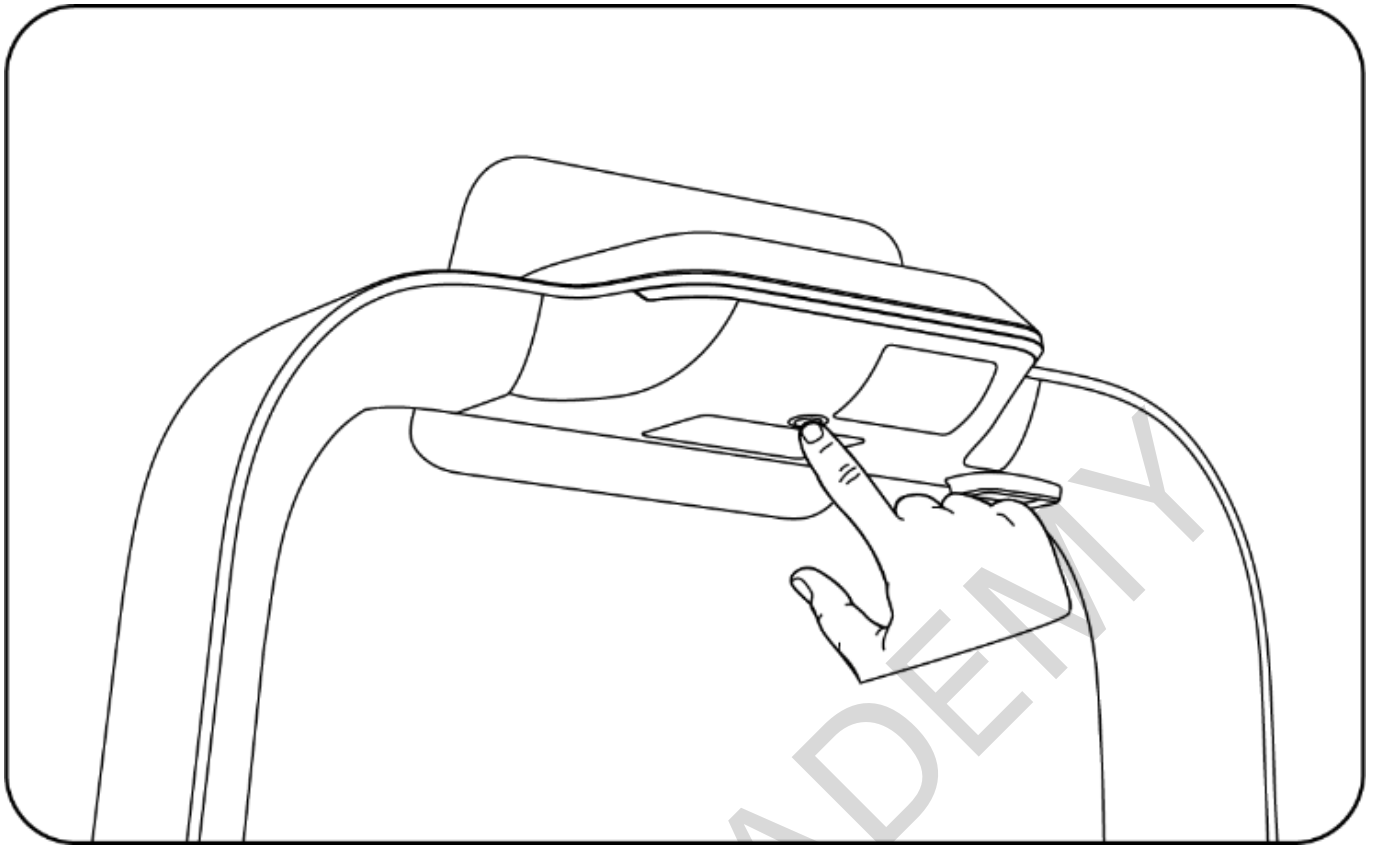

□Note

The system will automatically start Pudu APP by default after powering on. If not, tap the "Desktop" icon on the system desktop to start it.

Step 3 The robot is powered on, let's try it out!

## **Power off**

Press and hold the power switch for 3 seconds, and a shutdown prompt will pop up. Click "Confirm" and the light strip on the top of the robot and the screen will turn off, indicating that the robot has been successfully powered off.

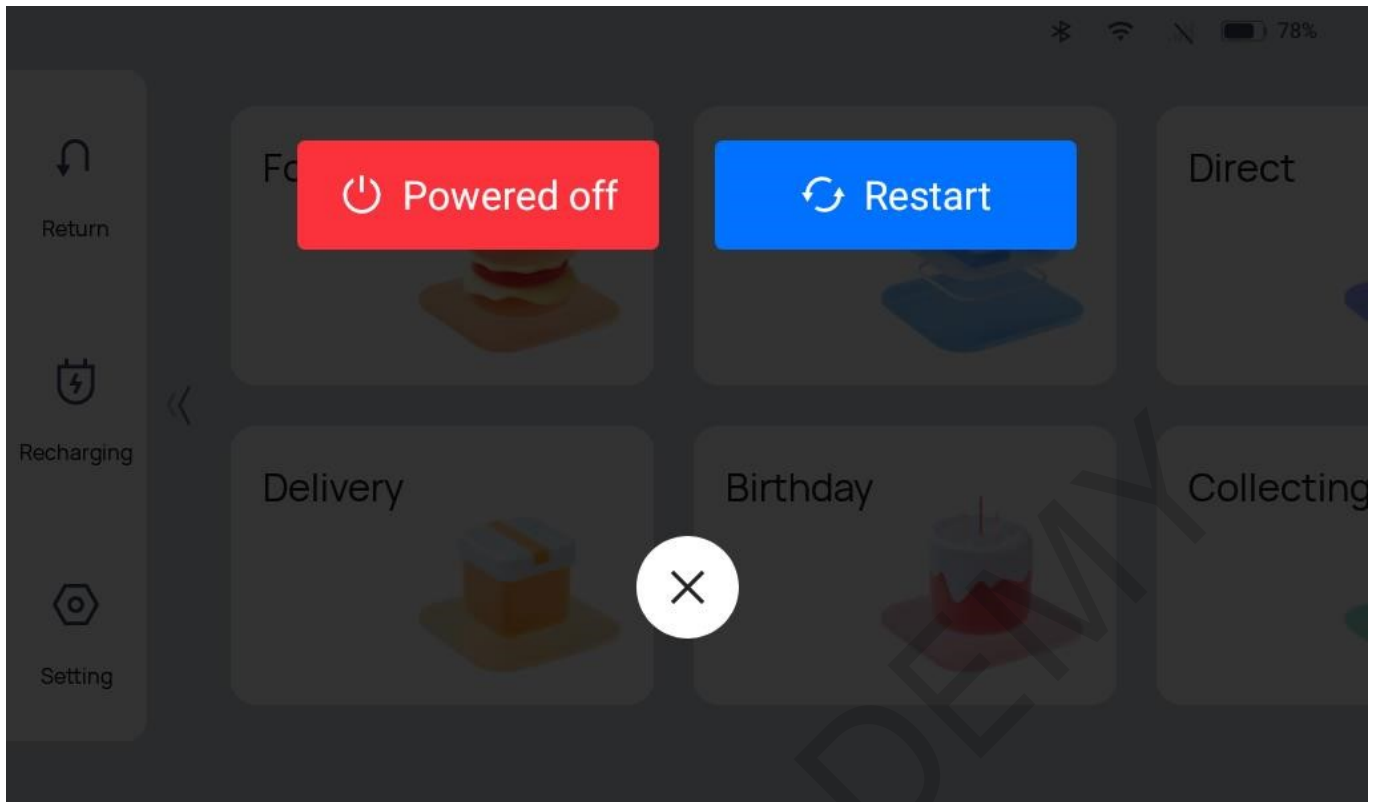

## Pause

While the robot is moving, the current task can be paused by tapping the screen. Tapping the screen again will resume the current task.

## Emergency stop

In n case of an emergency while the robot is moving, press the emergency stop switch to stop the robot. Turn the emergency stop switch clockwise and follow the on-screen prompts to resume the robot's operation.

## Task Scenarios

### Product Features

The robot comes with various modes, including Food delivery mode, Delivery mode, Cruise mode, Direct Delivery mode, Birthday mode, and Collection mode, to cater to the needs of different scenarios. After powering on the robot, you can select the mode as needed in the screen.

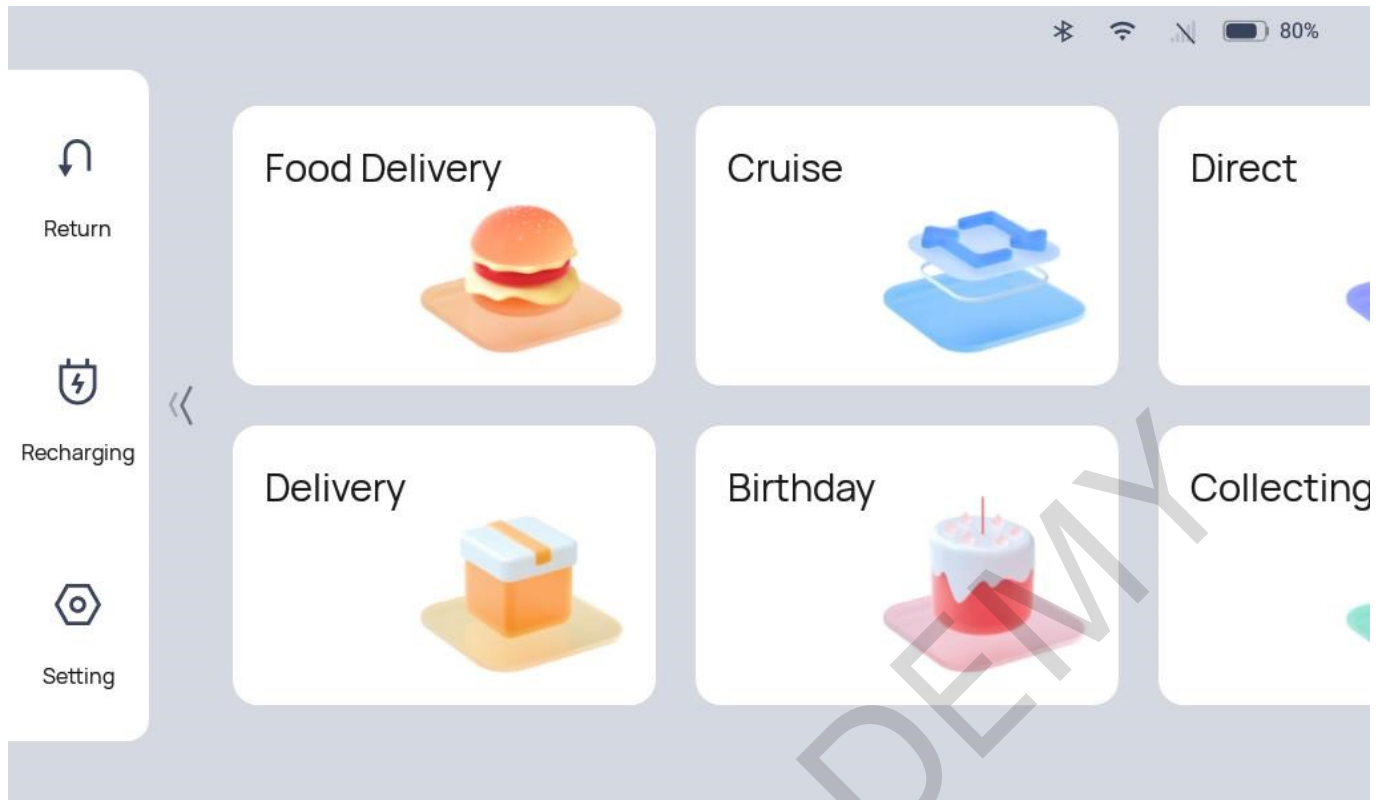

Mode	Description
Food delivery mode	The robot delivers food to multiple tables at the same time. After the dishes ordered by different customers are placed on the trays and the table numbers are entered, the robot automatically plans the best routes for delivery. After that, the robot automatically returns to the standby position.
Delivery mode	The robot delivers things to multiple tables at the same time. After the things ordered by different customers are placed on the trays and the destinations are entered, the robot automatically plans the best routes for delivery. After that, the robot automatically returns to the standby position.
Cruise mode	The robot circulates along a predetermined path with self-service drinks, desserts or napkins, and recommends them to customers by voice.
Direct Delivery mode	You can set a table with a certain number or the dish-washing room as the destination. After performing one-way delivery, the robot exits from the current task instead of returning to the pick-up position.
Birthday mode	The robot delivers birthday cakes or gifts to customers, accompanied by customized background music.
Collecting mode	In Collecting mode, the robot collects the things to be cleaned and delivers them to the collecting point or the transit point.

#### □Note

To ensure a stable and safe operation of the robot, it is recommended that the delivery speed be lower than 0.9m/s (2.95 ft/s), and the cruise speed at 0.1m/s (0.33 ft/s) or 0.6m/s (1.97 ft/s).

## Delivery Mode

In Delivery Mode, an item is delivered to a specified destination, with automatic return to the docking location after completing delivery to the final destination

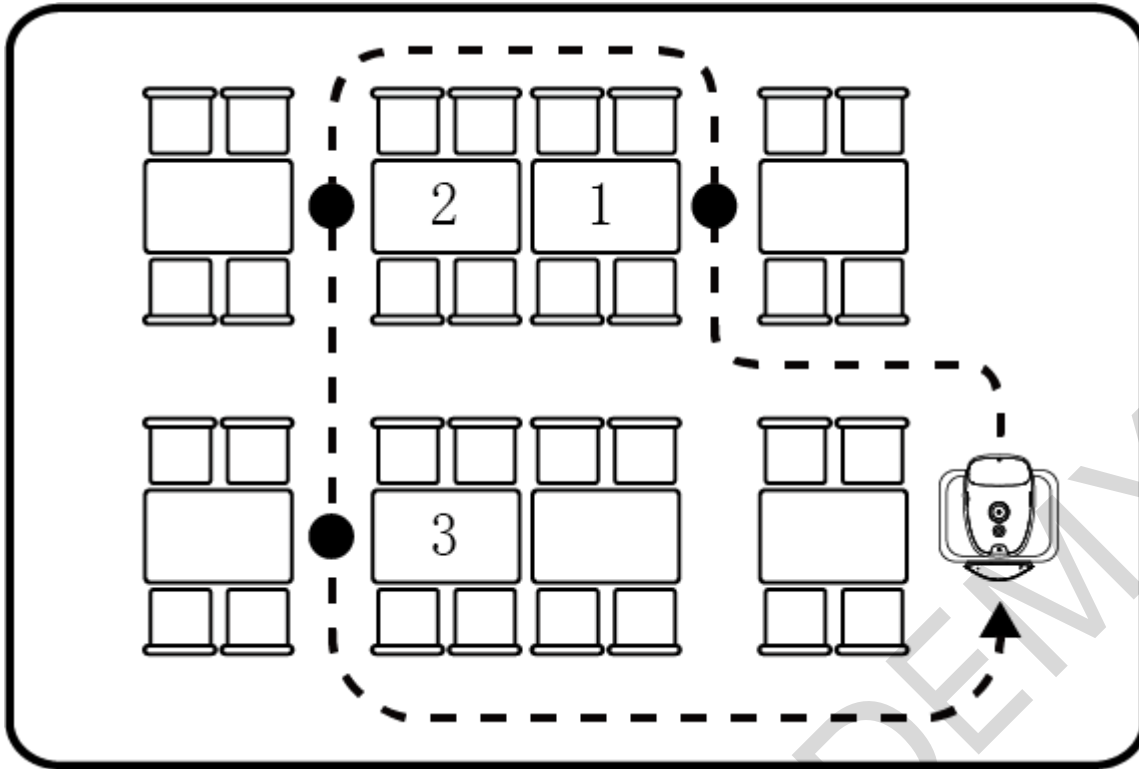

## How to Use the Main Processes in Delivery Mode

Step 1 On the robot's home page, select "Delivery" to access the main interface for delivery mode.

Step 2 Place the item on the corresponding tray.

Step 3 Tap on the tray bearing the item on the left side of the interface, then select the destination on the right side. The corresponding tray will immediately display the destination name.



Step 4 Once you have finished entering the destination, tap "Start". The robot will proceed to the corresponding destination.

Step 5 Once it reaches its destination, the robot will give a voice prompt. The operator will remove the item in accordance with the on-screen and voice prompts.



Step 6 Once the operator removes the item, tap "Done", and the robot will then begin executing its next task. If the robot has completed all tasks, it will return to the docking location.

During the delivery process, if it is necessary to edit a task, remove a meal in advance, cancel

all tasks, or return, you can tap on the robot's screen to pause the robot before proceeding with the operation. If there are no operations during the countdown period, the robot will continue running.

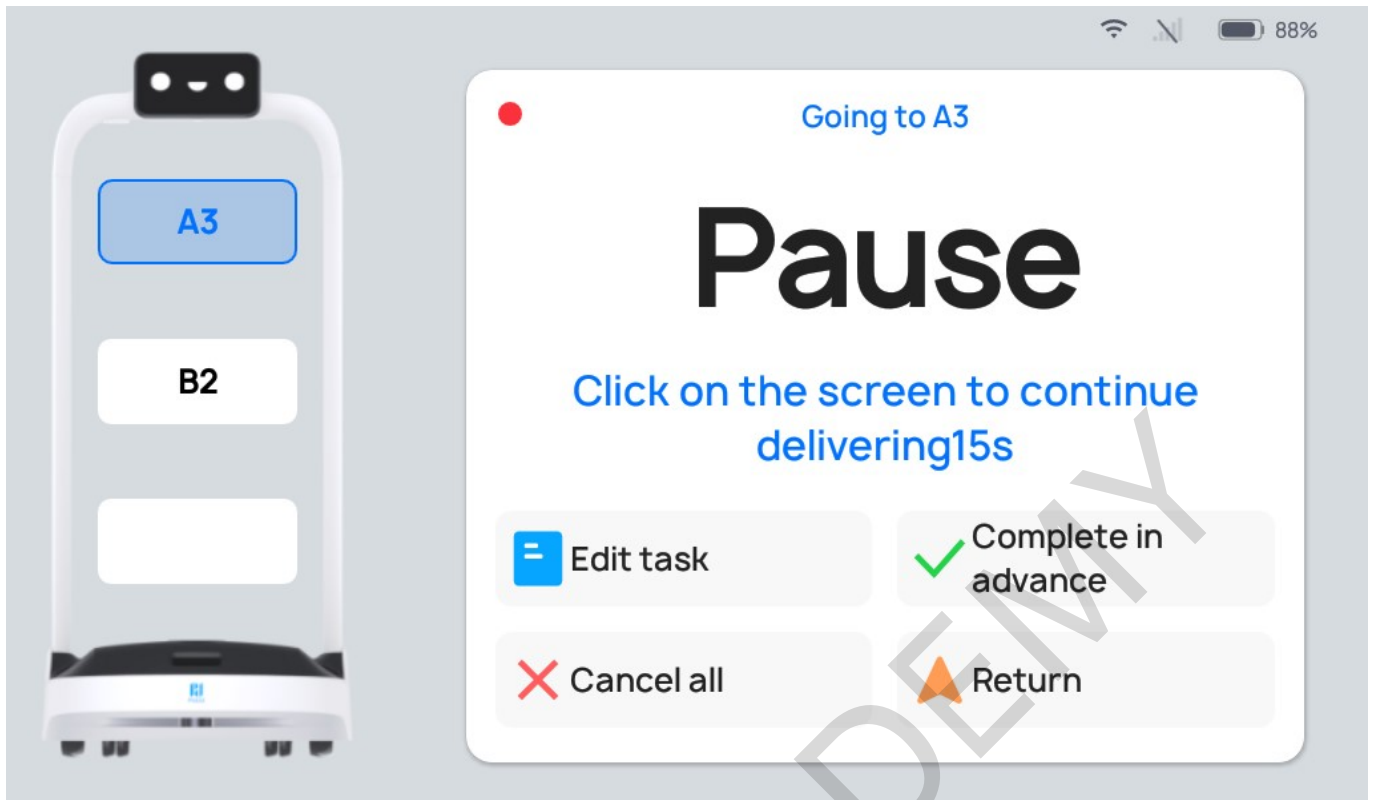

Button	Description
Edit task	Tap to modify the destination.
Complete in advance	Tap to Complete in advance and move on to the next task.
Cancel all	Tap to cancel all delivery tasks and not return to the docking location.
Return	Tap to return to the docking location.

## Description of Delivery Mode Settings

There is a "⚙️" button on the right side of the Delivery Mode interface. Tap it to configure the delivery mode settings. The following settings can be configured:

Settings	Description
Delivery arrival voice message	When this function is enabled, a customized voice message will play on arrival of a delivery task. If multiple voice messages are selected, one will play at random for each arrival.
Delivery arrival music	When this function is enabled, the robot will play music on arrival of a delivery task.
Music during delivery task	When this function is enabled, music will play during delivery task.
Multiple-location delivery with one tray	When this function is enabled, a single tray can be delivered to multiple corresponding locations.
Delivering speed	The robot can be configured to travel at a predetermined speed to a destination.
Return speed	The robot can be configured to travel at a predetermined speed when returning to the docking location.

Settings	Description
Task sequence	The criteria for determining the order of execution of robot delivery tasks can be adjusted.
Select docking location	Select the default docking location to which the robot will return.

Detailed Description:

### (1) Delivery arrival voice message

Users can customize the content played for the delivery arrival voice message; after choosing to play content for a customized voice message, the robot will no longer play the default voice message upon arriving at its destination.

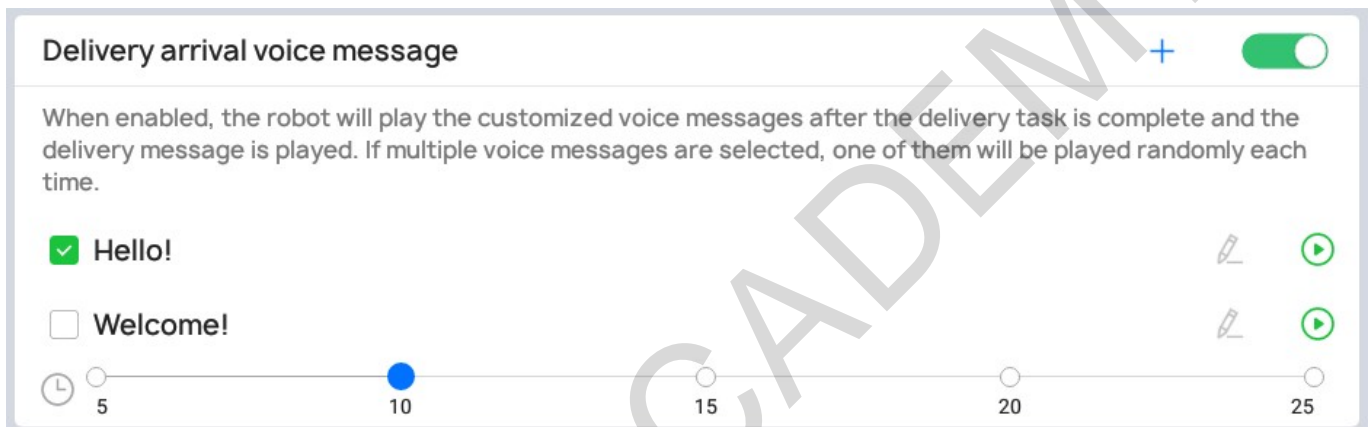

Steps for Adding a Customized Voice Message:

Step 1 Go to "Delivery arrival voice message" in the Delivery Mode "Settings" interface and enable the switch.

Step 2 In the "Delivery arrival voice message" field, enable Cruising Voice Messages and tap on the "+" for the pop-up Voice Message Text Editing window.

Step 3 In the Voice Message Text Editing window, enter the content you want to be played, and tap "Add/Save" to create a customized voice message. Before creating the voice message, you can tap on the "Test Play" button to test the voice message.

Step 4 Select the voice message you created, and it will play when a delivery arrives. If multiple voice messages are selected, the robot will randomly select one voice message to play upon arrival.

Note:

- Up to 20 voice messages can be added, and up to 200 English characters per voice message are supported.
- Multiple voice messages can be selected, and the robot will randomly select one voice message to play upon arrival of a delivery.
- If you need to delete a customized voice message, long press the corresponding voice message and tap "Delete".
- The playback interval can be set within the range of 5s-25s; the default is 5s. The playback interval can be manually changed. After making changes, save the settings.



## (2) Music during delivery task

The user can select the music that the robot plays in the process of traveling from the docking location to the destination in delivery mode. Steps for adding music during delivery tasks:

Step 1 In the home page interface, enter "Settings" - "Music Library," tap "Import Music" in the top right corner of the interface, and import the music by scanning the code with your phone.

Step 2 Go to "Music during delivery task" in the Delivery Mode "Settings" interface and enable the switch.

Step 3 By checking the box to select music, you can select the music that the robot plays upon arrival. If multiple voice messages are selected, the robot will randomly select one voice message to play upon arrival.

Note:

Added music can be automatically synced with the Delivery Mode music and played once selected:

- Up to 20 music files can be added to the music library, and the added music can be automatically displayed in the "Music during delivery task" list.
- Multiple music files can be selected, and the robot will randomly select one music file to play during the delivery process.

Music files cannot be deleted from the list during delivery tasks. If you need to delete a music file, you will need to go to "Settings" - "Music Library" to delete it.

## (3) Delivery arrival music

Users can select music to be played by the robot when it arrives at its destination in delivery mode; once the robot arrives at its destination, it will play the voice message, and then play the music.

Steps for Adding Delivery Arrival Music:

Step 1 In the home page interface, enter "Settings" - "Music Library," tap "Import Music" in the top right corner of the interface, and import the music by scanning the code with your phone.

Step 2 Go to "Delivery arrival music" in the Delivery Mode "Settings" interface and enable the switch.

Step 3 By checking the box to select music, you can select the music that the robot plays

upon arrival. If multiple voice messages are selected, the robot will randomly select one voice message to play upon arrival.

Note:

Added music can be automatically synced with the Delivery Mode music and played once selected:

- Up to 20 music files can be added to the Music Library, and the added music can be automatically displayed in the "Delivery arrival music" list.
- Multiple music files can be selected, and the robot will randomly select one music file to play upon arrival of a delivery task.

- Music cannot be deleted from the Delivery Arrival Music list; if you need to delete a music file, you will need to go to "Settings" -"Music Library" to delete it.

(4) Delivering speed

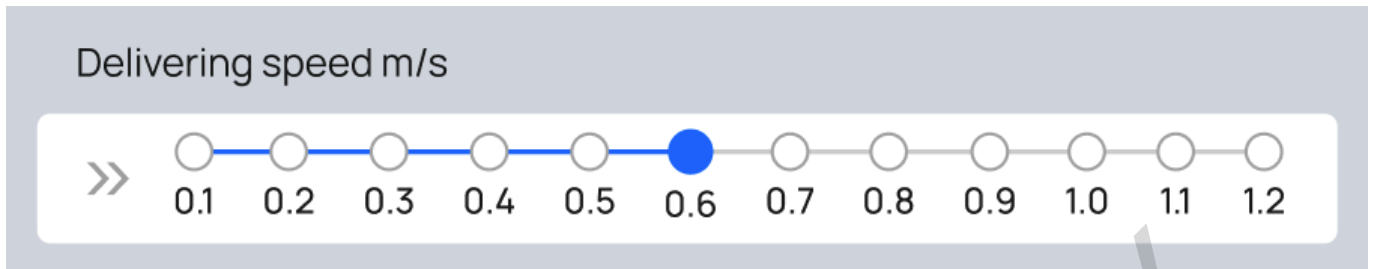

The robot can be configured to travel at a predetermined speed to a destination. The default speed is 0.8m/s (2.62 ft/s), and this can be adjusted by dragging the cursor within the range of 0.1m/s(0.33ft/s) to 1.2m/s(3.93ft/s).

Note:

If you need to enable higher speeds, you can go to "Settings" -"Advanced" and enable the "High-Gear Traveling Speeds" switch.

(5) Return speed

The robot can be configured to return to its docking location at a predetermined speed. The default speed is 0.8m/s (2.62 ft/s), and this can be adjusted by dragging the cursor within the range of 0.1m/s (0.33ft/s) to 1.2m/s (3.93ft/s).

Note:

If you need to enable higher speeds, you can go to "Settings" -"Advanced Settings" and enable the "High-Gear Traveling Speeds" switch.

(6) Task sequence

You can choose between Prioritized Delivery by Distance and First Come First Served:

- Prioritized Delivery by Distance: Before executing a task, the robot will choose the table that is currently at the closest distance and prioritize it in completing delivery.
- First Come First Served: Delivery is completed in the order in which tables are entered.

(7) Select docking location

Select the default docking location to which the robot will return.

### More About Delivery Mode

Settings	Description
Task history	You can view the previous task executed in the current mode
Steady mode	When this function is enabled, the robot can travel smoothly at a low speed

Settings	Description
Default input method	You can modify the destination search method: Direct location selection/smart location search

### Detailed Description:

#### 1. Task history



In the delivery interface, tap the "L" button to view the delivery status of the robot's previous task.

#### 2. Steady mode

You can choose whether or not the robot will use steady mode in the process of traveling. In steady mode, the robot will travel at a lower speed, and start and brake more smoothly. The method of use is as follows:

In the "Settings" - "Speed" interface, once the Steady Mode switch is enabled, the symbol "" will be displayed on the Delivery Mode home page:

- Tap the "" icon on the right side of the Delivery interface, and the icon will change to "", indicating that Steady Mode is enabled.
- Tap the "" icon on the right side of the Delivery screen, and the icon will change to "", indicating that Steady Mode is disabled.

#### (3) Default input method



By tapping the "Magnifying glass icon" button on the right side of the Delivery Mode home page, you can modify the input method for selection of a delivery destination in the Delivery interface. There are two input methods:

- Direct destination selection: The destination list is in a tiled display in the window on the right side of the interface, and you manually and directly find and select the table number.
- Smart destination search: The robot automatically extracts the first character of all destination names for display, and gradually filters out the destinations by screening the characters as you proceed.

On the "Settings" - "Advanced Settings" page, under "Default Input Method," you can select the default input method.

## Default input method



Select location directly

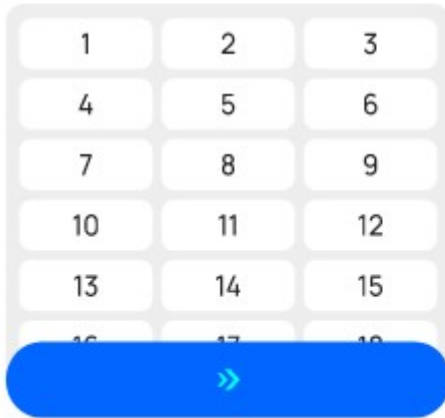

Intelligently select location

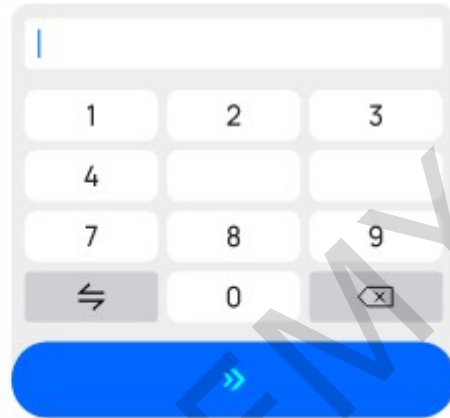

## Food Delivery Mode

In Food Delivery Mode, food is delivered to a specified destination, with automatic return to the docking location after completing delivery to the final destination.

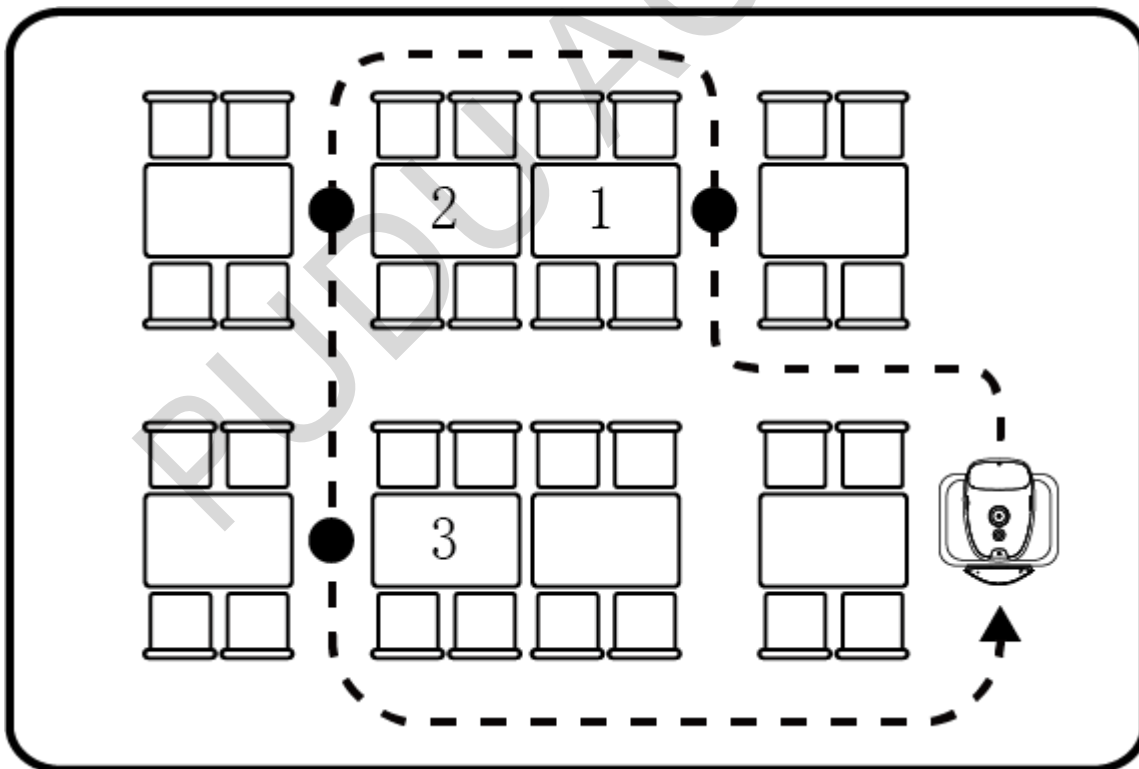

## How to Use the Main Processes in Food Delivery Mode

Step 1 On the robot's home page, select "Food Delivery" to access the main interface for Food Delivery Mode.

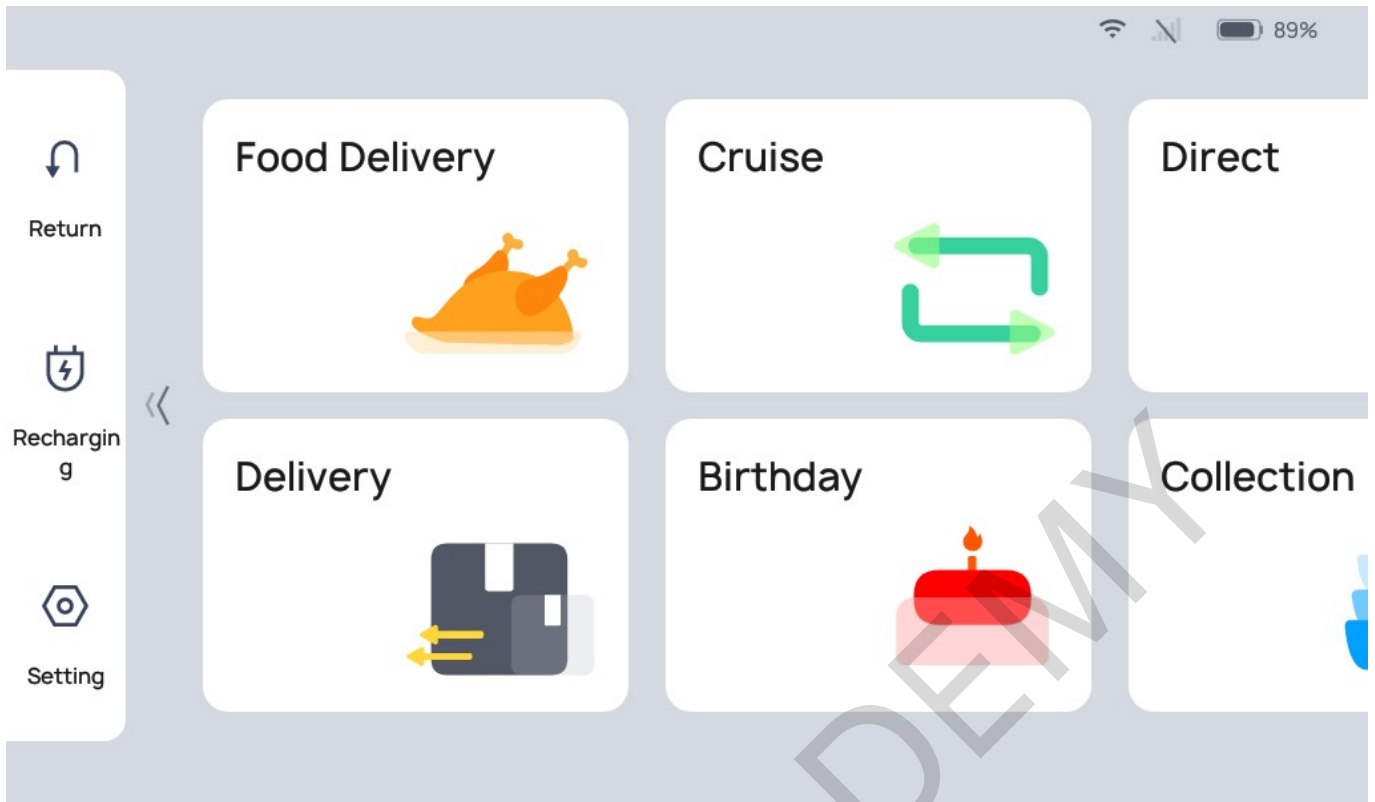

Step 2 Place the dishes on the corresponding tray.

Step 3 On the left side of the interface, tap on the tray the dish was placed on, and select the destination on the right side. The corresponding destination name will be displayed above the tray on the left side of the interface.

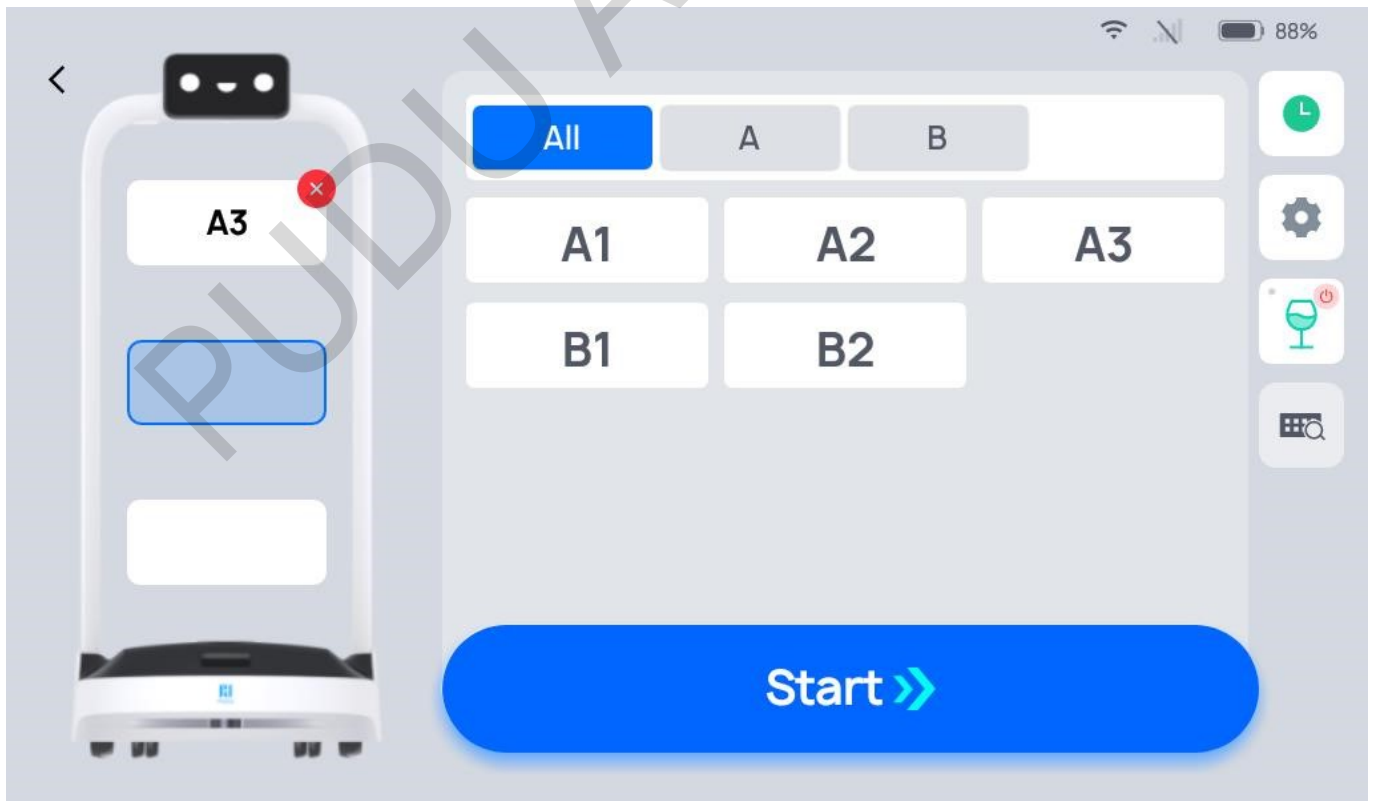

Step 4 Once you have finished entering the destination, tap "Start" The robot will proceed to the corresponding destination.

Step 5 Once it reaches its destination, the robot will give a voice prompt. The server will remove the dishes in accordance with the on-screen and voice prompts.

Step 6 Once the server removes the item, they will tap "Done", and the robot will begin executing its next task. If the robot has completed all tasks, it will return to the docking location.

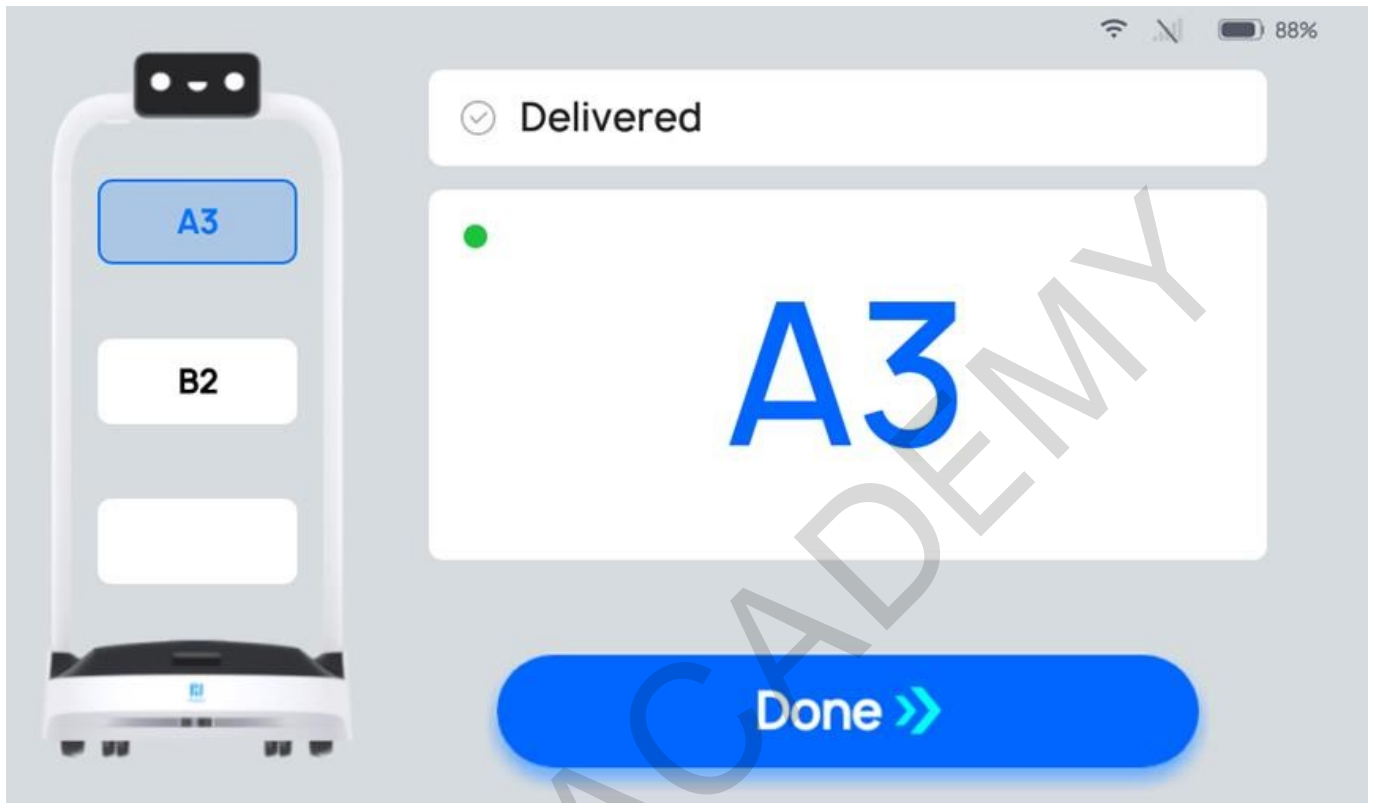

During the food delivery process, if it is necessary to edit a task, Complete in advance, cancel all tasks, or return, you can tap on the robot's screen to pause the robot before proceeding with the operation. If there are no operations during the countdown period, the robot will continue running.

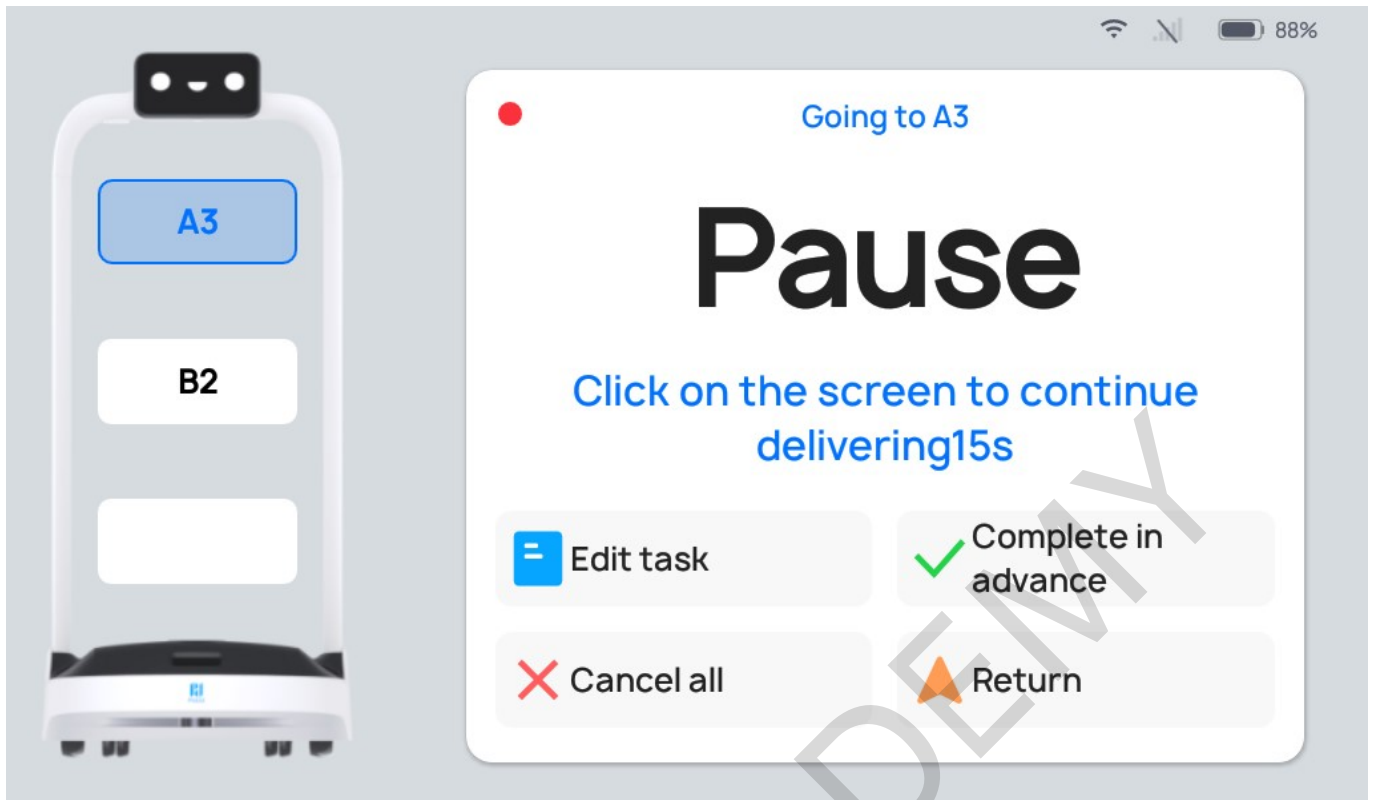

Button	Description
Edit task	Tap to modify the table number for food delivery task.
Complete in advance	Tap to Complete in advance and move on to the next task.
Cancel all	Tap to cancel all food delivery tasks and not return to the docking location.
Return	Tap to return to the docking location.

## Description of Food Delivery Mode Settings

There is a "⚙️" button on the right side of the Food Delivery Mode interface. Tap it to configure the delivery mode settings. The following settings can be configured:

Settings	Description
Food delivery arrival voice message	When this function is enabled, a customized voice message will play on arrival of a delivery. If multiple voice messages are selected, one will play at random for each arrival.
Food delivery arrival music	When this function is enabled, the robot will play music when it arrives on a food delivery task.
Play music during food delivery	When this function is enabled, music will be played while en route for food delivery.
Delivery to multiple locations with a single tray	When this function is enabled, a single tray can be delivered to multiple corresponding locations.
Delivering speed	The robot can be configured to travel at a predetermined speed to a destination.

Settings	Description
Returns speed	The robot can be configured to travel at a predetermined speed when returning to the docking location.
Task sequence	The criteria for determining the order of execution of robot food delivery tasks can be adjusted.
Selection docking location	Select the default docking location to which the robot will return.

The detailed method of operation for the specific settings is identical to the delivery mode settings. For details, see "2.2.2 Description of Delivery Mode Settings."

## More About Food Delivery Mode

Other functions available in the Food Delivery Mode interface include:

Settings	Description
Task history	You can view the previous task executed in the current mode
Steady mode	When this function is enabled, the robot can travel smoothly at a low speed
Default input method	You can modify the destination search method: Direct location selection/smart location search

The specific, detailed method of operation is identical to the Delivery Mode settings. For details, see "2.2.3 More About Delivery Mode".

## Cruise Mode

Cruise mode is for cruising around in a specific environment on a patrol. In the process of cruising, the robot can play certain voice messages and play music.



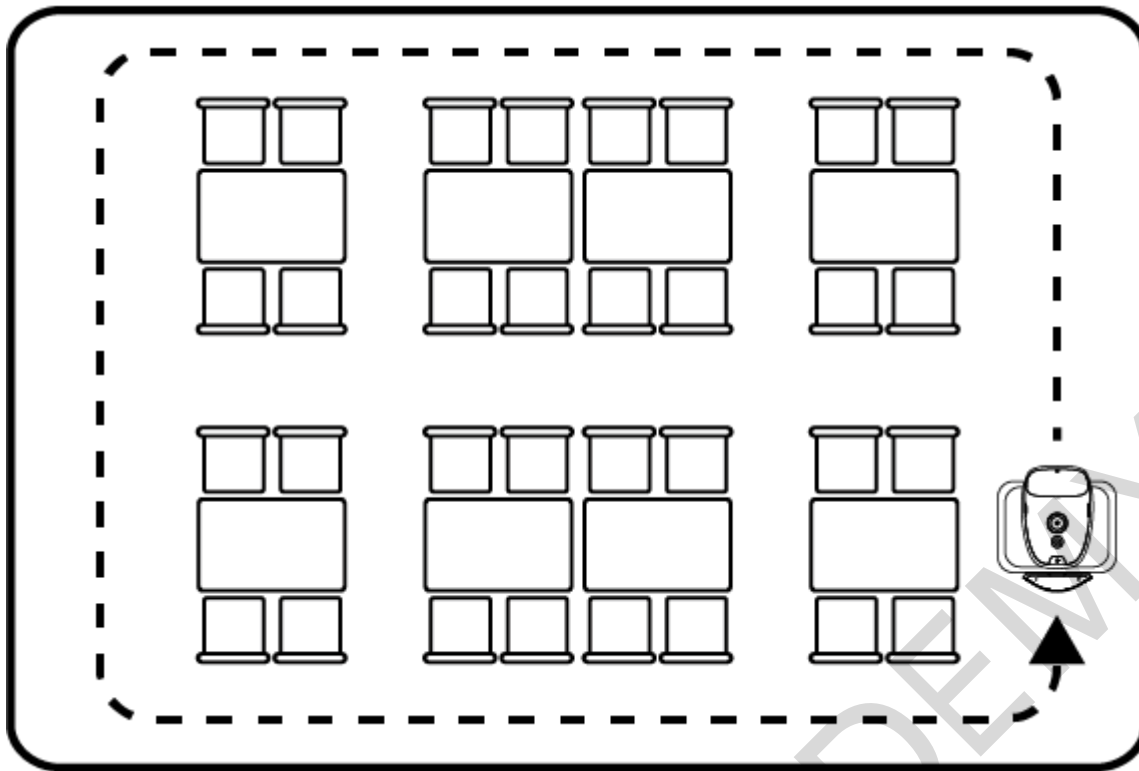

## How to Use the Main Processes for Cruise Mode

Step 1 Select "Cruise" on the home page. After accessing the Cruise Mode interface, the cruising routes will be displayed.

Step 2 Select the cruising route you want to use and tap "Start". The robot will begin to cruise along the cruising route.

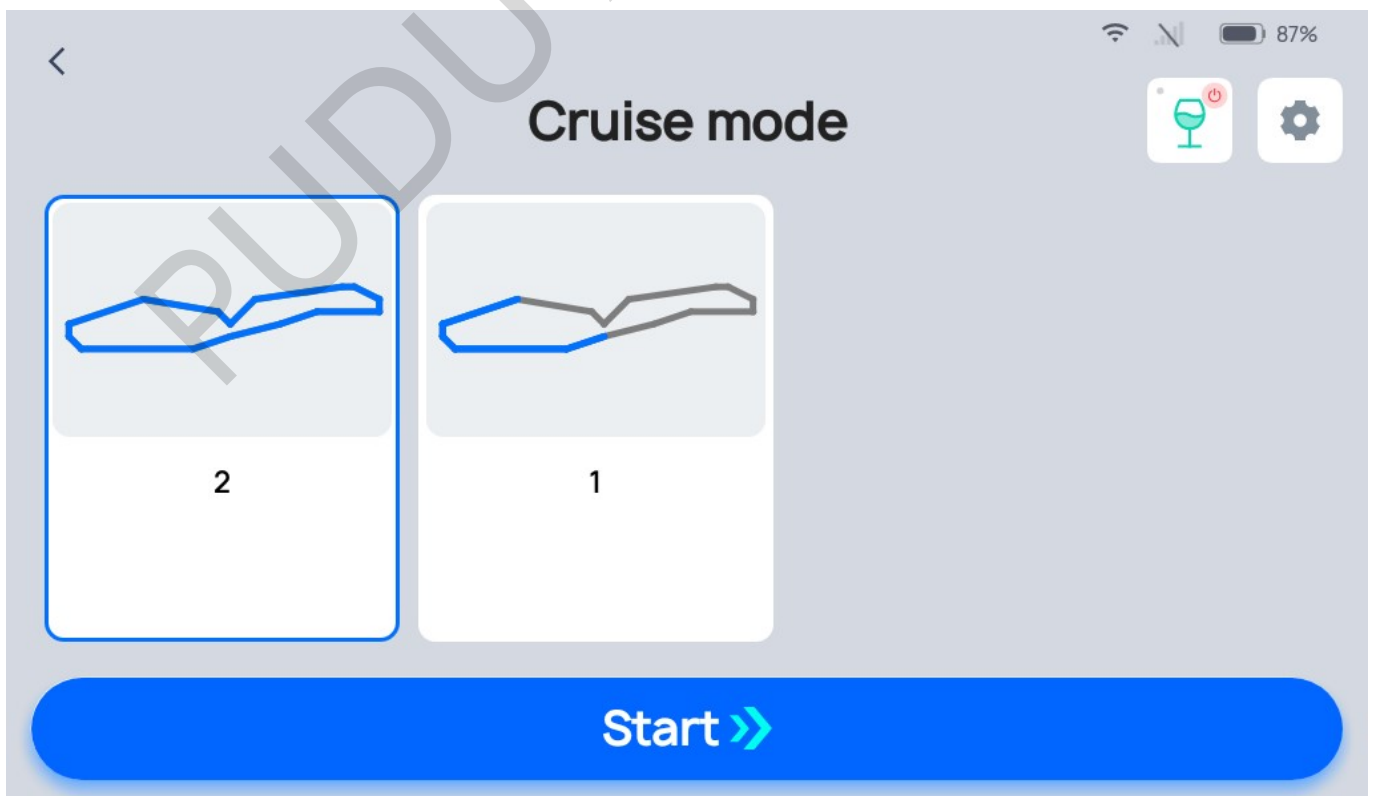

If you want the robot to pause, tap pause on the robot's screen. Once the pause countdown has

ended, the robot will continue moving.

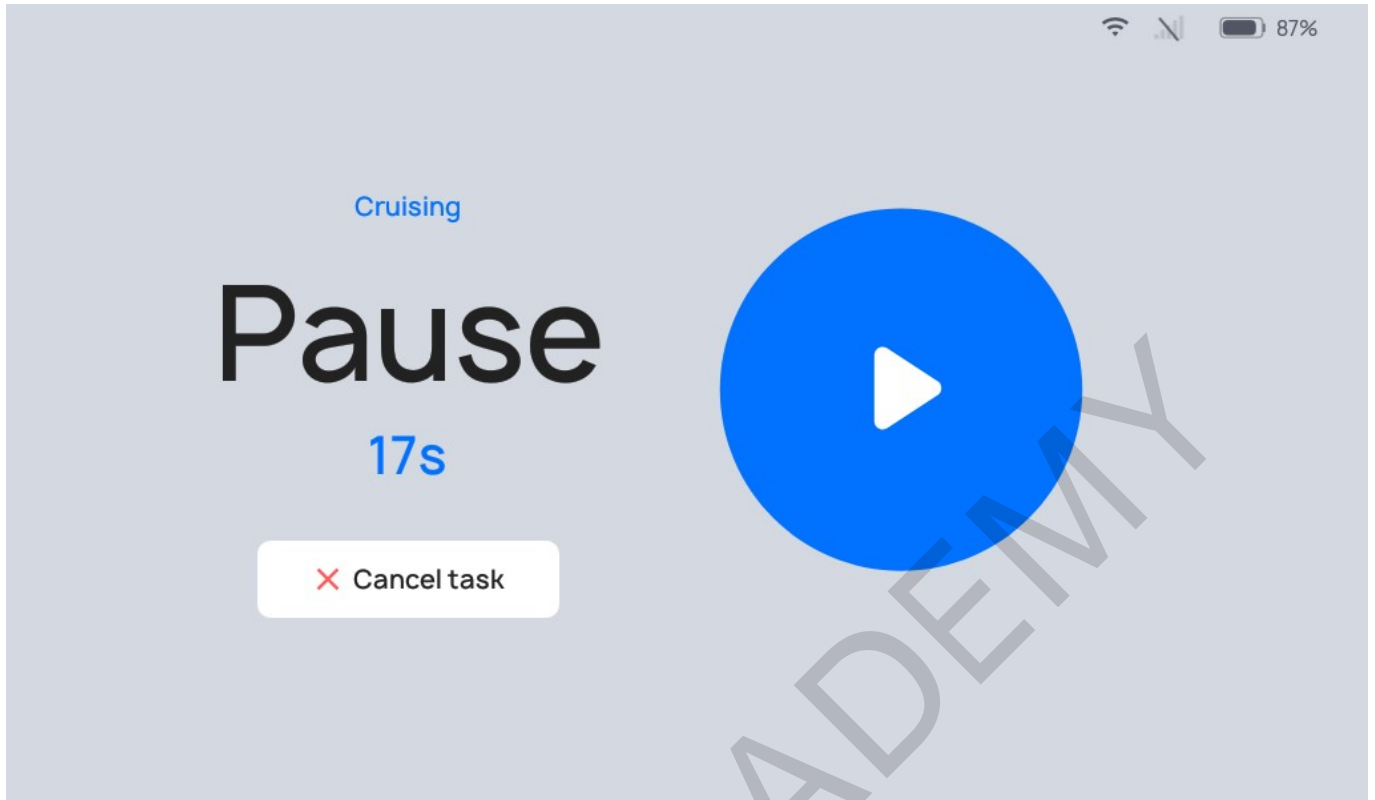

While paused, tap "Cancel task" to end the cruising task.

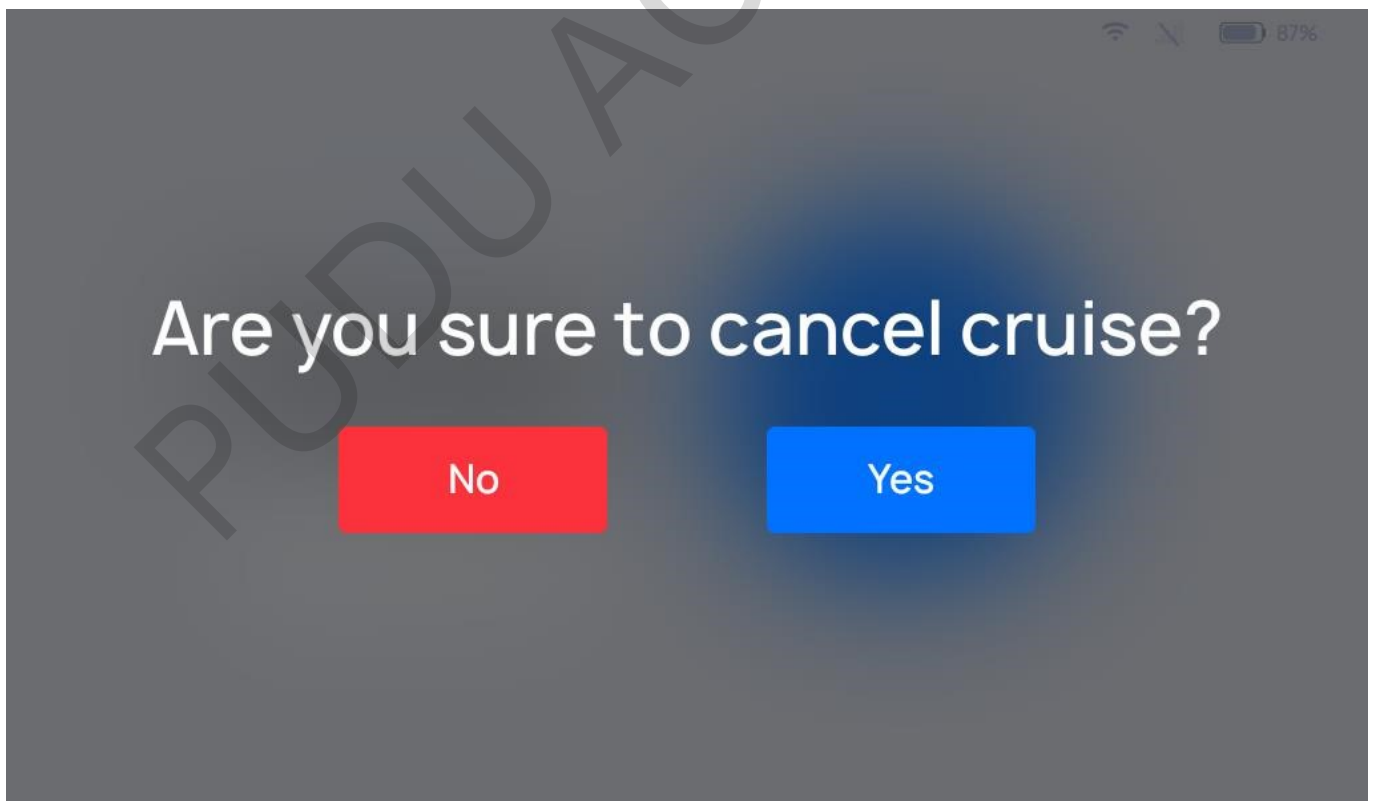

If a rest point is set on the cruising route, the robot will travel to the rest point and stop. You will need to manually tap on the screen for the robot to proceed to the next point on its route.

## Description of Cruise Mode Settings

There is a  button at the top of the Cruise Mode interface. Tap it to configure the Cruise mode settings. The following settings can be configured:

Settings	Description
Cruising voice	When this function is enabled, a voice message will be played while cruising.
Voice message for stays along the cruise route	When this function is enabled, a voice message will play upon arrival at rests while cruising.
Cruise music	When this function is enabled, music will play while cruising.
Waiting time at cruise locations	When this function is enabled, the robot will pause upon arriving at a rest point, and proceed to the next location once the countdown ends.
Cruising speed	The robot's traveling speed while cruising can be adjusted.

Detailed Description:

### (1) Cruising voice

Users can customize the content played for cruising voice messages; once customized voice message content is selected to be played, the robot will play the voice message at certain intervals while cruising. Steps for Adding Voice Messages:

Step 1 Go to "Cruising voice" in the "Settings" interface for Cruise mode and enable the switch.

Step 2 In the "Cruising voice" field, enable Cruising Voice Messages and tap on the "+" to open the Edit Voice Message Text window.

Step 3 In the Voice Message Text Editing window, enter the content you want to be played, and tap "Add/Save" to create a customized voice message. Before creating the voice message, you can tap on the "Test Play" button to test the voice message.

Step 4 Select the voice message you created, and it will play when a delivery arrives. If multiple voice messages are selected, the robot will randomly select one voice message to play upon arrival.

Note:

- Up to 20 voice messages can be added, and up to 100 Chinese characters per voice message are supported.
- Multiple voice messages can be selected, and one voice message will be randomly selected to play while cruising.
- If you need to delete a customized voice message, long press the corresponding voice message and tap "Delete".
- The playback interval can be set within the range of 5s-25s; the default is 5s. The playback interval can be manually changed. After making changes, save the settings

### (2) Voice message for stays along the cruise route

Users can choose for the robot to play a voice message at rest points while in Cruise mode. Steps for

## Adding a Cruising Rest Point:

Step 1 Go to "Voice message for stays along the cruise route" in the "Settings" interface for Cruise mode and enable the switch.

Step 2 In the "Voice message for stays along the cruise route" field, enable Cruising Voice Messages and tap on the "+" to open the Edit Voice Message Text window.

Step 3 Select the voice message you created, and it will play when the robot arrives at a rest point. If multiple voice messages are selected, the robot will randomly select one voice message to play upon arrival.

Note:

- Up to 20 voice messages can be added, and up to 200 English characters per voice message are supported.
- Multiple voice messages can be selected, and one voice message will be randomly selected to play while cruising.
- If you need to delete a customized voice message, long press the corresponding voice message and tap "Delete".

The playback interval can be set within the range of 5s-25s; the default is 5s. The playback interval can be manually changed. After making changes, save the settings.

## (3)Cruise Music

The user can choose for the robot to play music while in Cruise mode. The robot will travel and play voice messages while cruising. Steps for Adding Cruising Music:

Step 1 In the home page interface, enter "Settings" - "Music Library," tap "Import Music" in the top right corner of the interface, and import the music by scanning the code with your phone.

Step 2 Go to "Cruise Music" in the Cruise mode "Settings" interface and enable the switch.

Step 3 By checking the box to select music, you can select the music that the robot plays upon arrival. If multiple music files are selected, the robot will randomly select the music to play while cruising

Note:

Music added to the Music Library can be automatically synced to the Cruise mode music and can be played once selected:

- Up to 20 music files can be added to the Music Library, and the added music can be automatically displayed in the "Cruising Music" list.
- Multiple music files can be selected, and music will be randomly selected to play while cruising.
- Music cannot be deleted from the Cruising Music list. If you need to delete a music file, you will need to go to "Settings" - "Music Library" to delete it.

## 4. Waiting time at cruise locations

The robot's stoppage time at rest points can be set, and the robot will count down at the rest point

based on a predetermined period of time. The steps for settings are as follows:

Step 1 Go to "Waiting time at cruise locations" in the Cruise mode "Settings" interface and enable the switch;

Step 2 In the text box, enter the stoppage time at rest points (input range of 1s-600s). Once the robot's countdown for the rest time ends, it will proceed to the next rest point.

#### (5) Cruising Speed

The robot can be configured to adjust the travelling speed at cruising. The default speed is 0.8m/s (2.62ft/s), and this can be adjusted by dragging the cursor within the range of 0.1m/s (0.33ft/s) to 1.2m/s (3.93ft/s).

Note:

If you need to enable higher speeds, you can go to "Settings" - "Advanced Settings" and enable the "High-Gear Traveling Speeds" switch.

### More About Cruise mode

Other functions available in the Cruise mode interface include:

Content	Description
Steady mode	When this function is enabled, the robot can travel smoothly at a low speed

The specific, detailed method of operation is identical to the Delivery Mode settings. For details, see "32.2.3 More About Delivery Mode."

### Direct Mode

In Direct Mode, the robot can execute a one-way transport operation and remain at the delivery point upon delivery, for use by personnel at the delivery point.

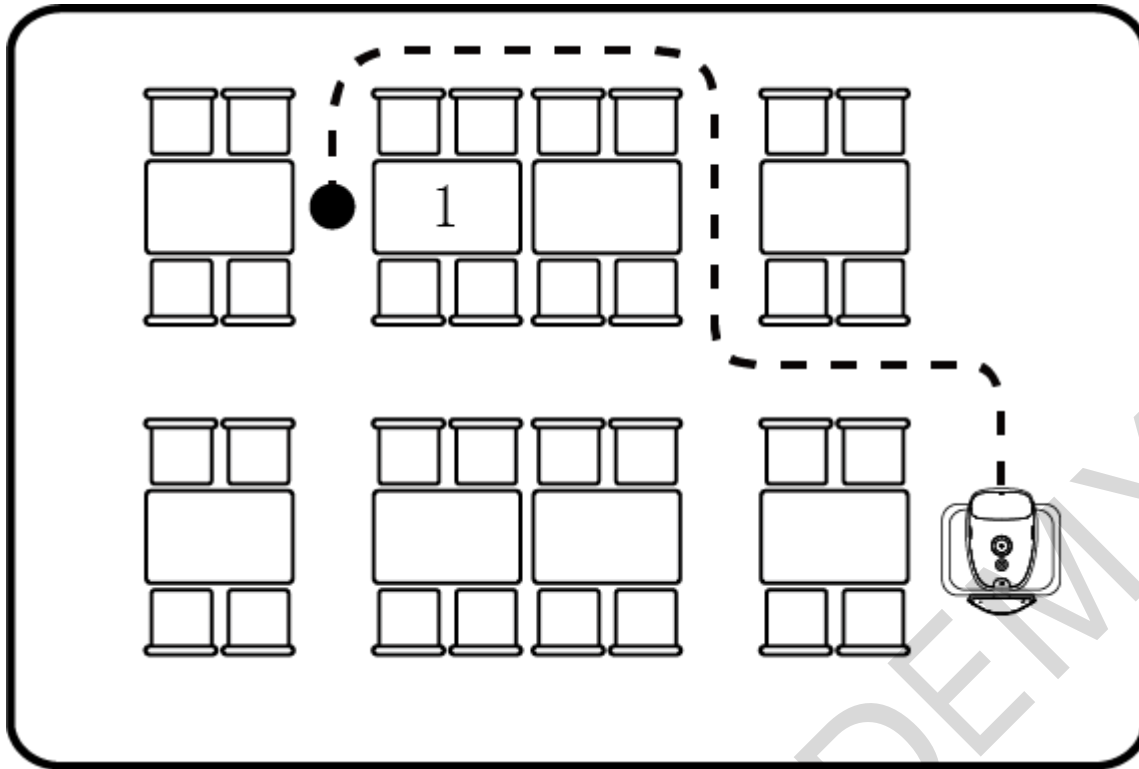

## How to Use the Main Processes for Direct Mode

The operating steps are as described below.

Step 1 On the robot's home page, select "Direct".

Step 2 In the Direct Mode interface, tap the button to select the destination name; after tapping, the destination name will be displayed on the tray. Once you tap the "Start", the robot will start direct task.

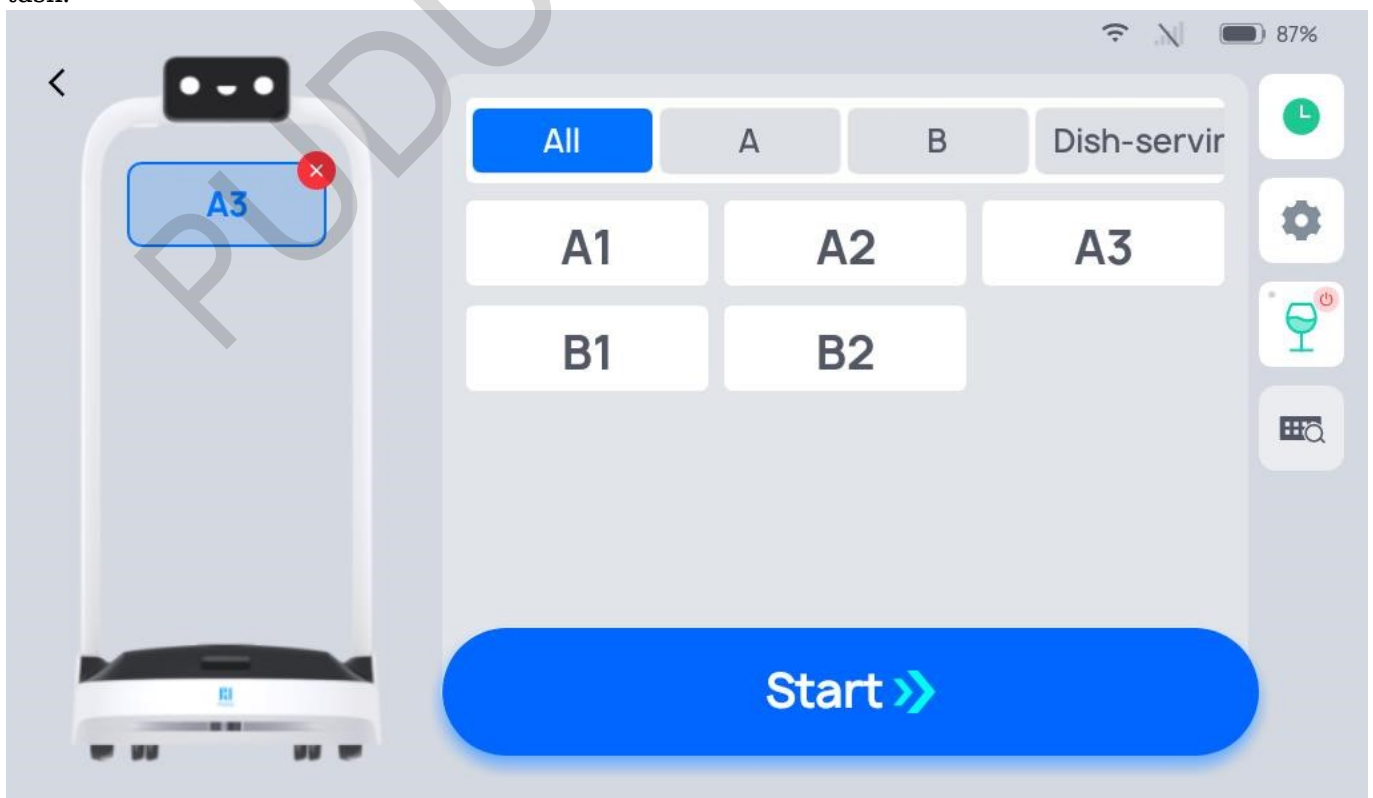

## □ Description

In Direct Mode, only one destination can be selected.

Step 3 Upon reaching the destination, tap "Done" button, and the task will be completed.

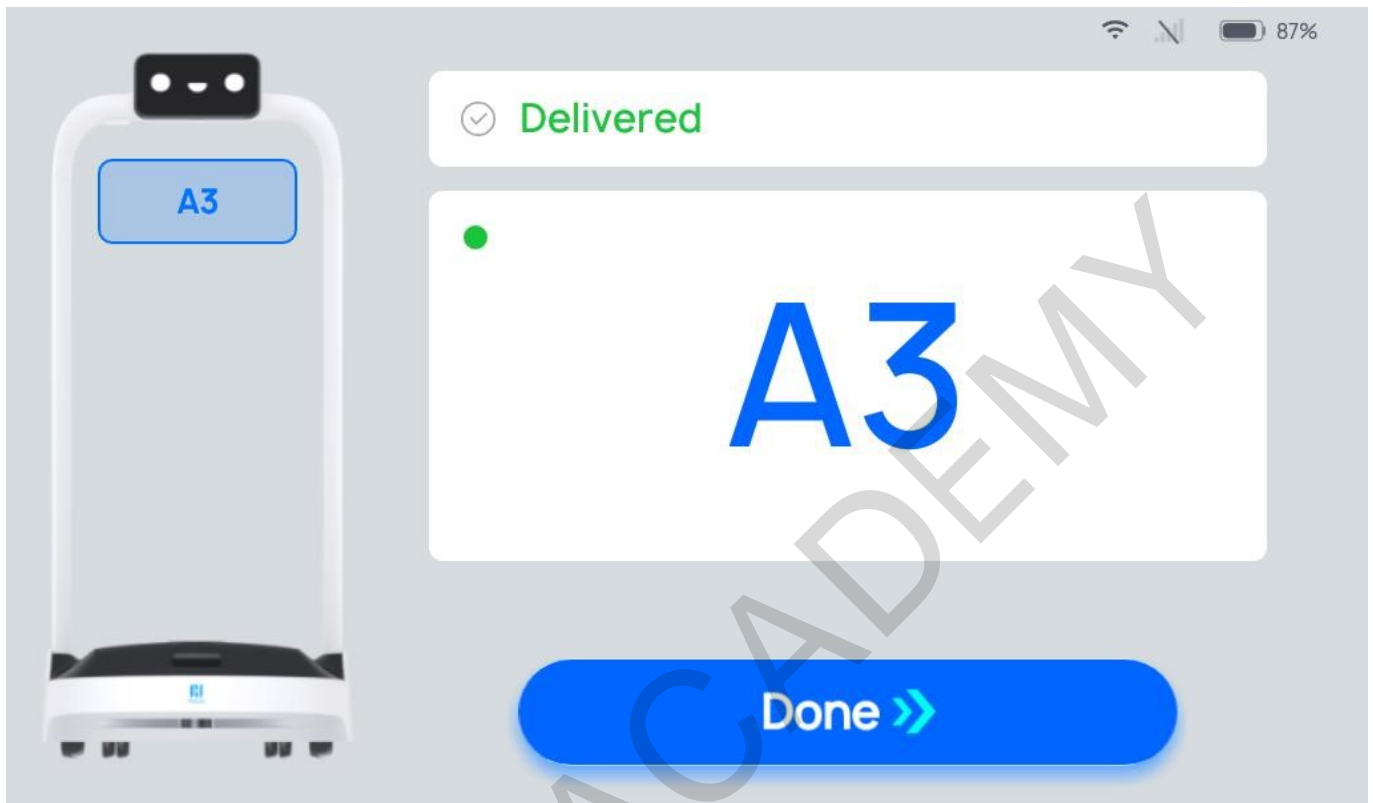

During the process of Direct, if you need to edit a task, Complete in advance, cancel all tasks, or return, you can tap the robot's screen to pause the robot before proceeding with the operation. If there are no operations during the countdown period, the robot will continue running.

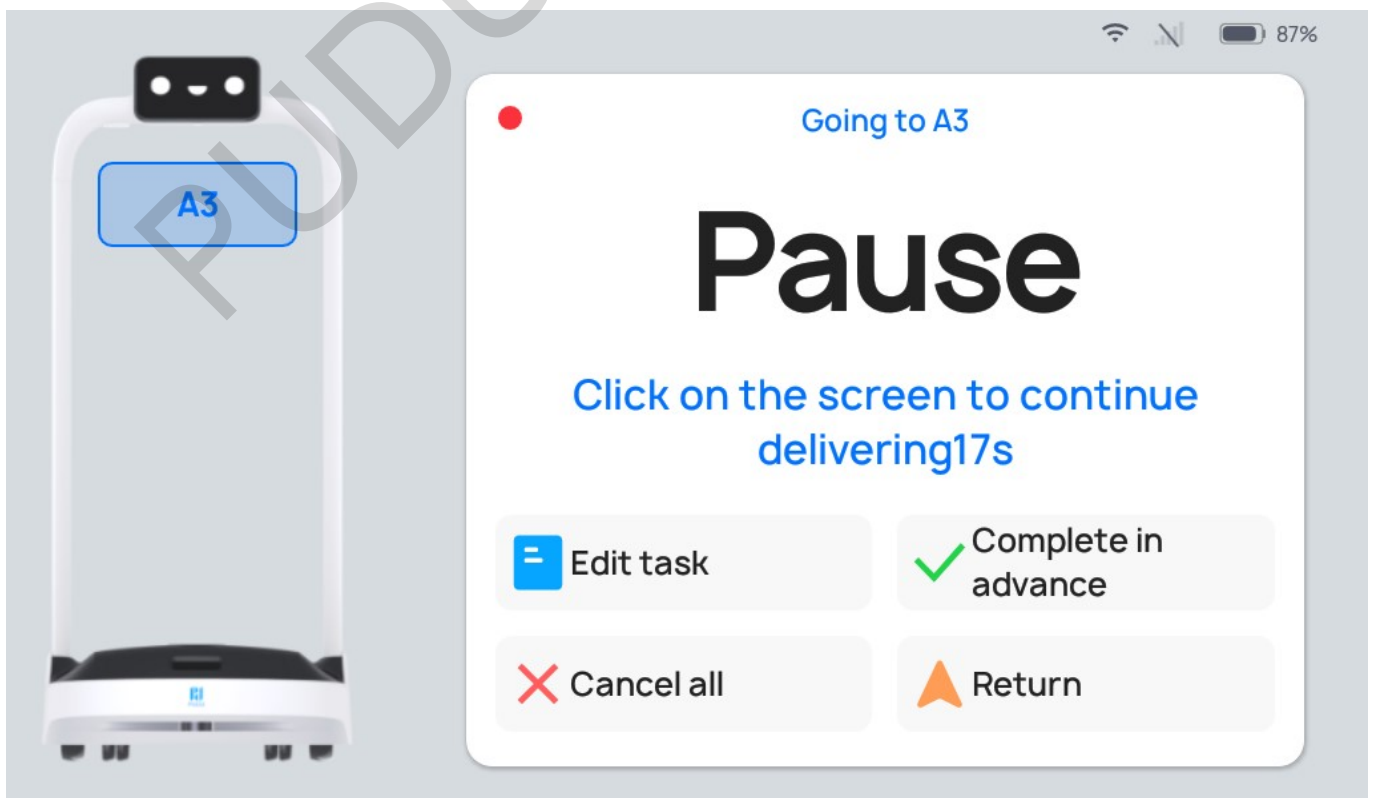

Button	Description
Edit task	Tap to modify the destination.
Complete in advance	Tap this button to force Complete the task, and the interface will return to the Direct Mode interface.
Cancel all	Tap to cancel all tasks and not return to the docking location.
Return	Tap to return to the docking location

## Description of Direct Mode Settings

There is a  button on the right side of the Direct Mode screen. Tap it to configure the Direct Mode settings. The following settings can be configured:

Settings	Description
Direct arrival voice message	When this function is enabled, a customized voice message will play upon arrival on a Direct task. If multiple voice messages are selected, one will randomly play upon each arrival.
Direct arrival Music	When this function is enabled, the robot will play music upon arrival on a Direct task.
Music during direct task	When this function is enabled, music will play while the route for Direct tasks.
Delivering speed	The robot can be configured to travel at a predetermined speed to a destination.

The detailed method of operation for the specific settings is identical to the Delivery Mode settings. For details, see "3.2.2.2 Description of Delivery Mode Settings".

## More About Direct Mode

Other functions available in the Direct Mode interface include:

Settings	Description
Task history	You can view the previous task executed in the current mode
Steady mode	When this function is enabled, the robot can travel smoothly at a low speed
Default input method	You can modify the destination search method: Direct location selection/smart location search

The detailed method of operation for the specific settings is identical to the Delivery Mode settings. For details, see "3.2.2.2 Description of Delivery Mode Settings"

## Birthday Mode

Birthday Mode is chiefly used in the settings of sending gifts and playing birthday songs to celebrate a birthday. Tap the menu bar at the docking location and select "Birthday".



## How to Use the Main Processes in Birthday Mode

Step 1 On the home page, select "Birthday" to access the main page for Birthday Mode.

Step 2 In Birthday Mode, tap the table number button on the right side to select the target table number; after tapping, the selected table number will be displayed on the robot's tray.

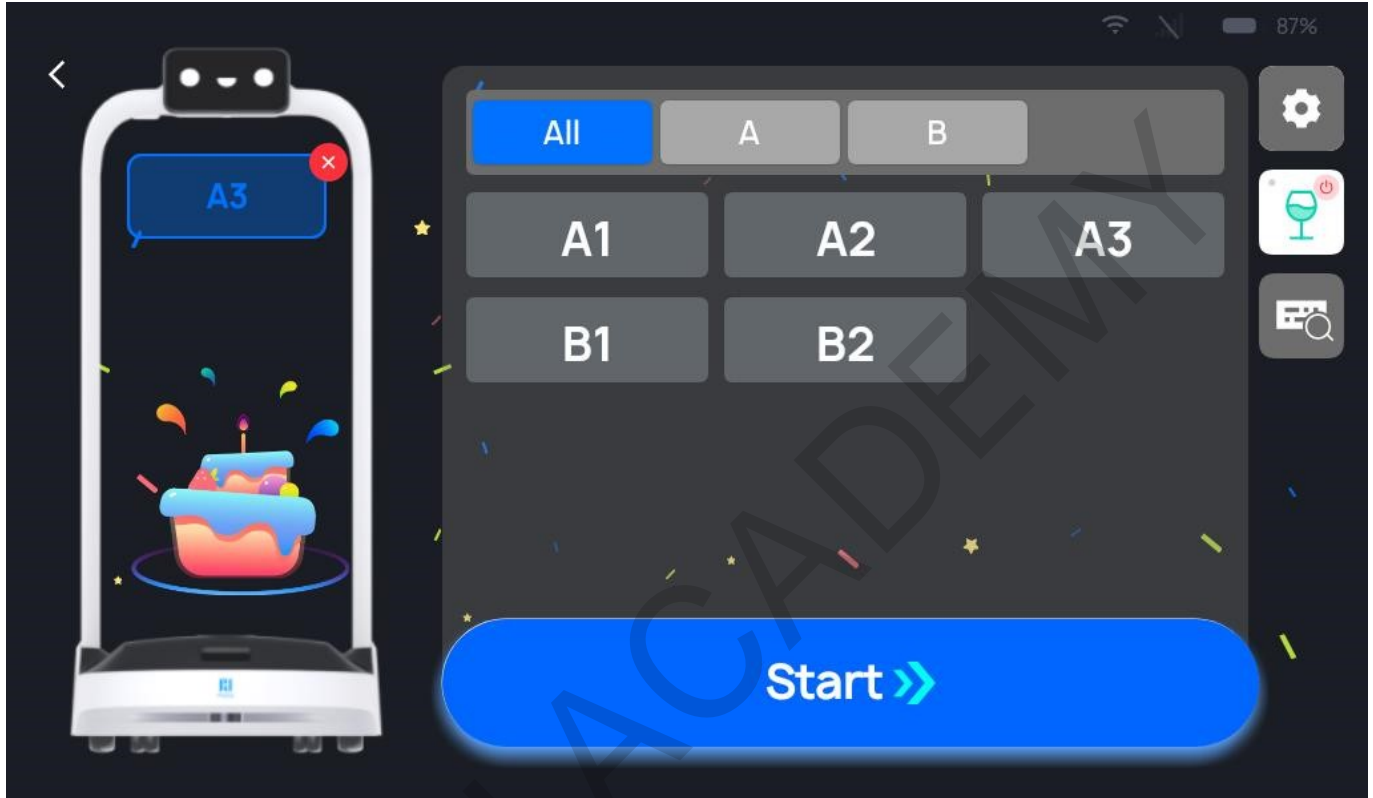

### □ Description

Only one table can be selected in Birthday Mode.

--Tap "Start", and the robot will follow the set route to reach the destination and play the relevant voice message and music in Birthday Mode.

Step 3 When the task is finished, tap "Done", and the robot will return to the docking location.

During the process of delivering birthday gifts, if it is necessary to edit a task, Complete in advance, cancel all tasks, or return, you can tap on the robot's screen to pause the robot before proceeding with the operation. If there are no operations during the countdown period, the robot will continue running.

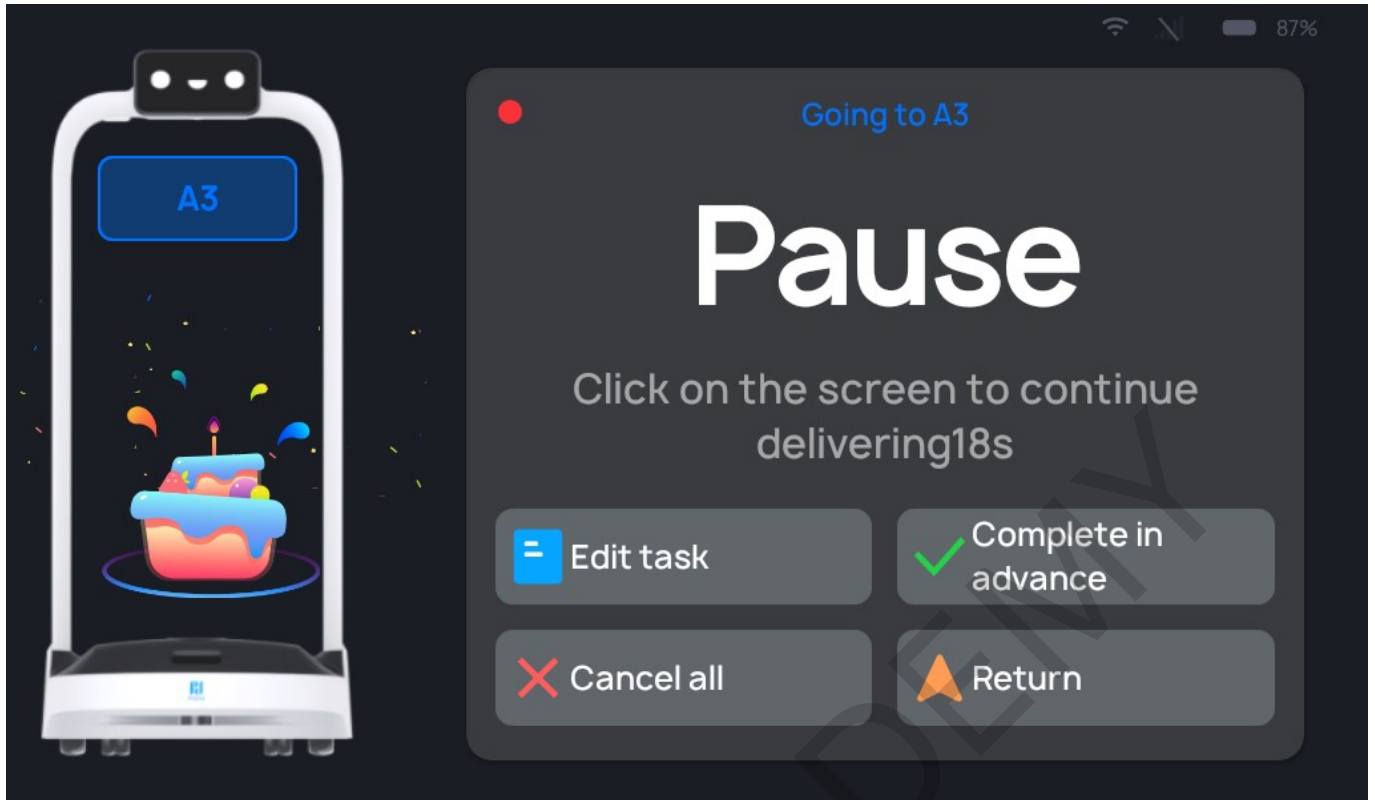

Button	Description
Edit task	Tap to modify the birthday celebration destination.
Complete in advance	Tap this button to force complete the task and return to the docking location.
Cancel all	Tap to cancel all tasks and not return to the docking location.
Return	Tap to return to the docking location.

## Description of Birthday Mode Settings

There is a "⚙️" button on the right side of the Birthday Mode screen. Tap it to configure the Birthday Mode settings. The following settings can be configured:

Settings	Description
Birthday arrival voice Message	When this function is enabled, a customized voice message will play upon arrival for a Birthday Mode task. If multiple voice messages are selected, one will play at random upon each arrival.
Birthday arrival Music	When this function is enabled, the robot will play music upon arrival for a Birthday Mode task.
Music during birthday task	When this function is enabled, music will play while the route for birthday tasks.
Delivering Speed	The robot can be configured to travel at a predetermined speed to a destination.
Return Speed	The robot can be configured to travel at a predetermined speed when returning to the docking location.

The other settings in Birthday Mode are identical to the Delivery Mode settings. For details, see "2.2.2 Description of Delivery Mode Settings."

## More About Birthday Mode

Other functions available in the Birthday Mode interface include:

Settings	Description
Task history	The previous task executed in the current mode can be viewed.
Steady mode	When this function is enabled, the robot can travel smoothly at a low speed.
Default input method	You can modify the destination search method: Direct location selection/smart location search.

The specific method of operation is identical to the Delivery Mode settings. For details, see "2.2.3 More About Delivery Mode"

## Collection Mode

Collection mode is used for the task of Collecting items such as plates, parts. The robot can deliver the collecting items from the designated point to the transit location or collection location

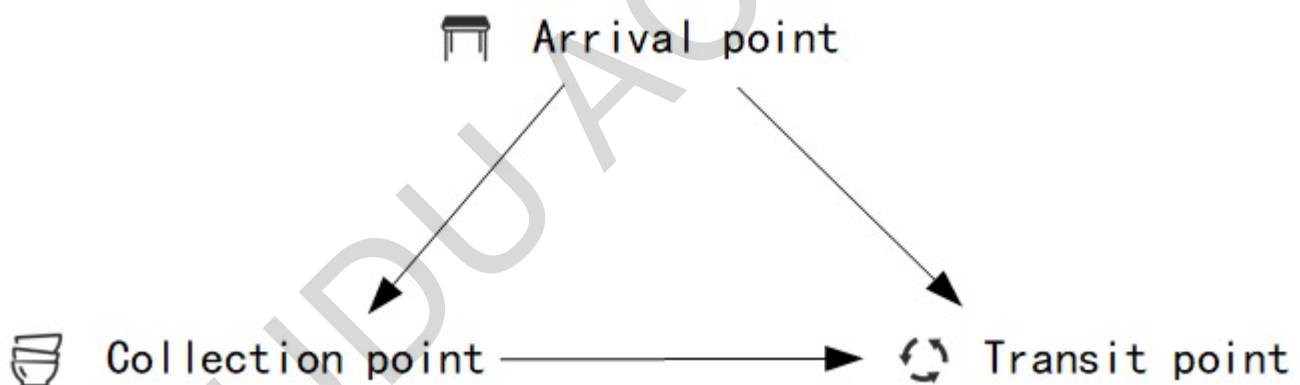

### How to Use the Main Processes in Collection mode

Step 1 On the robot's home page, select "Collection" to access the main interface for collection mode.

Step 2 Select the destination on the right side. Once you have finished entering the destination, tap "Start". The robot will proceed to the corresponding destination.

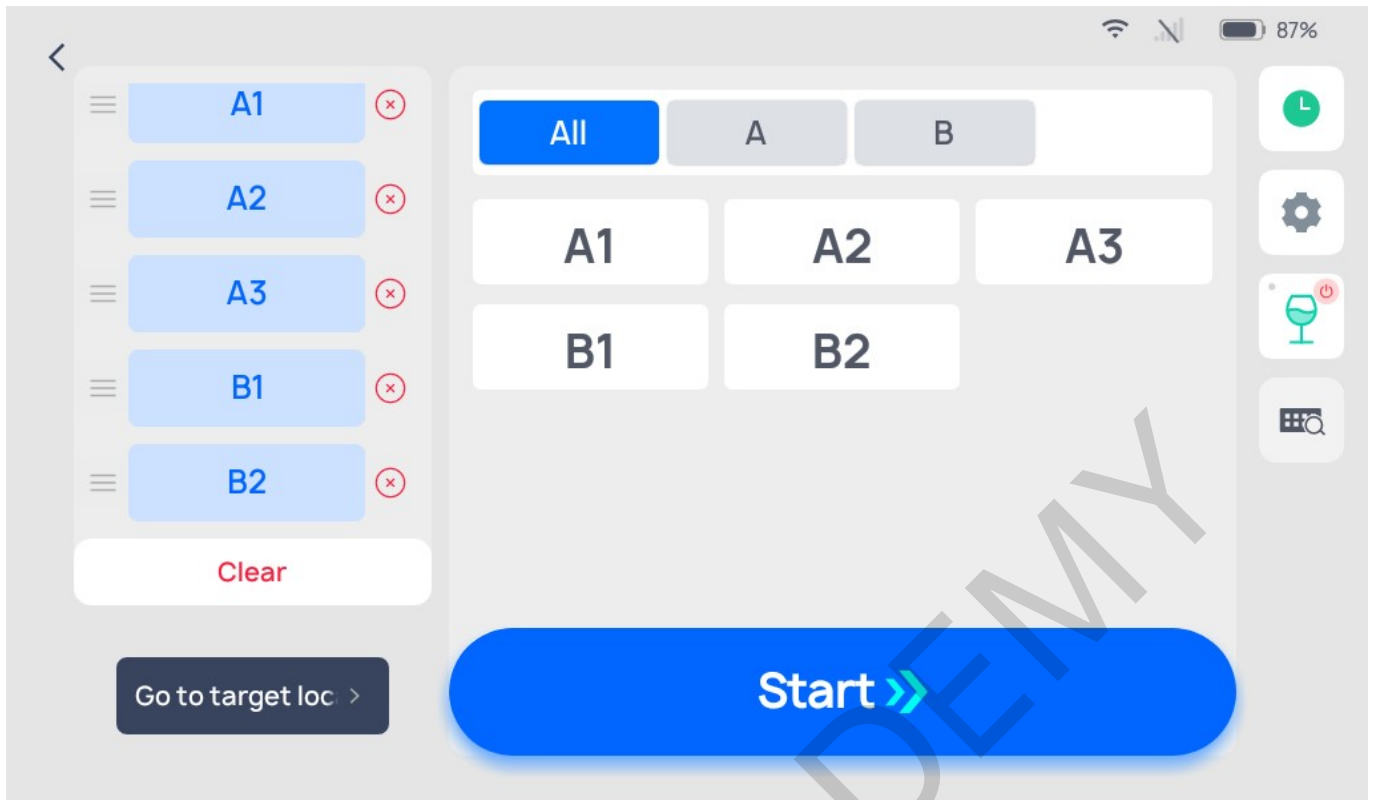

Step 3 When robot reaches its destination, the operator can put items on robot's trays and tap "Next task". And then, the robot will then begin executing its destination.

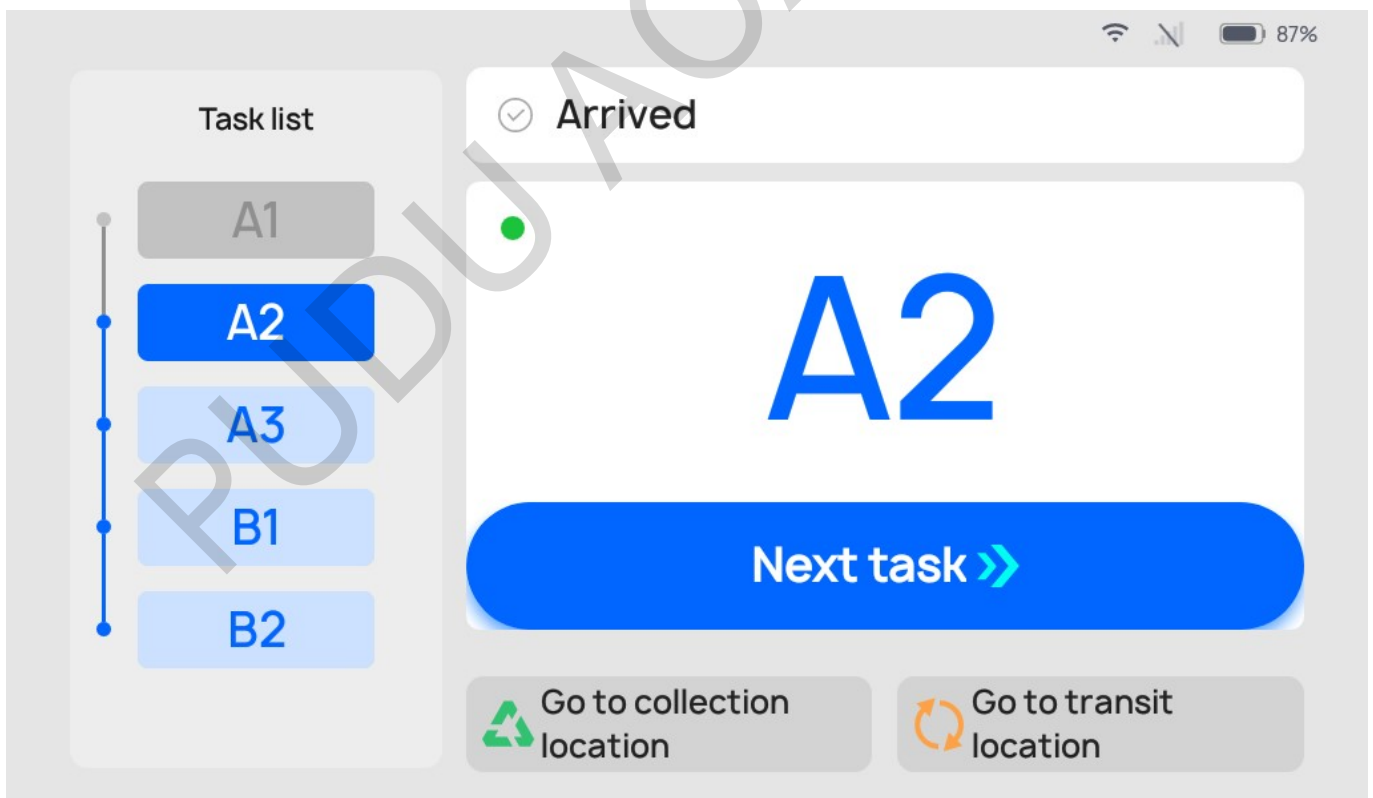

Step 4 After the robot reaches all the destinations, click "Next task" and the robot will execute action according to whether the "transit location" is set in the map:

- When there is a transit location in the map, the robot will go to the transit location. And the robot will stay at transit location.

When there is no transit location in the map, the robot will go directly to the collection location. And it will go to docking location, after you click "Done".

Note:

When there is no transit location in the map, the "Go to the transit location " button in the Collection mode will be automatically replaced with "Return ". After clicking, the robot will go directly to the docking location. Other pages are same for it.

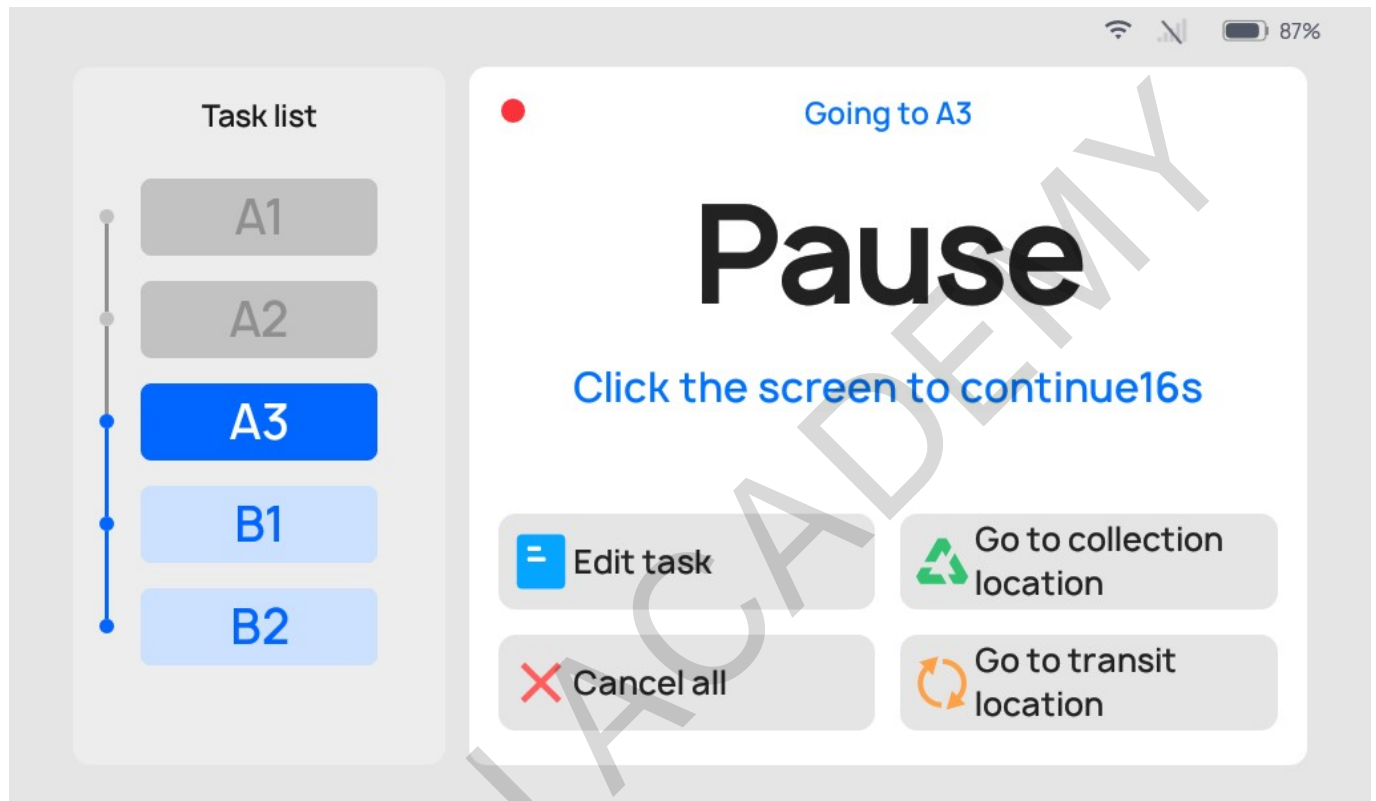

During the Collecting process, if it is necessary to edit a task, go to collection location, cancel all, or return, you can tap on the robot's screen to pause the robot before proceeding with the operation. If there are no operations during the countdown period, the robot will continue running.

Button	Description
Edit Task	Tap to modify the destination.
Go to collection location	Tap to force robot to go to collection location
Cancel all	Tap to cancel all tasks and not return to the docking location.
Return	Tap to return to the docking location.

## Description of Collection Mode Settings

There is a "⚙️" button on the right side of the Collection Mode interface. Tap it to configure the collection mode settings. The following settings can be configured:

Settings	Description
Collection arrival music	When this function is enabled, the robot will play music when it arrives on a collection task.
Music during collection task	When this function is enabled, music will be played while the route for collection task.
Delivering Speed	The robot can be configured to travel at a predetermined speed to a destination.
Return Speed	The robot can be configured to travel at a predetermined speed when returning to the docking location.
Select transit location	Select the default transit location that robot goes to.
Select collection location	Select the default collection location that robot goes to.

The detailed method of operation for the specific settings is identical to the delivery mode settings. For details, see "2.2.2 Description of Delivery Mode Settings."

## More About Collection mode

Other functions available in the Collection mode interface include:

Settings	Description
Task history	The previous task executed in the current mode can be viewed.
Steady mode	When this function is enabled, the robot can travel smoothly at a low speed.
Default input method	You can modify the destination search method: Direct location selection/smart location search.

The specific method of operation is identical to the Delivery Mode settings. For details, see "2.2.3 More About Delivery Mode".

## Settings

Swipe the tab at the left-hand side of the robot's homepage to access the "Settings" button. Tap to access the general setup screen for the robot. The setup interface allows you to configure the robot's operational settings.

Settings	Description
Basic Settings	Set screen brightness and language.
Network	Can be set as wireless LAN or 4G network. If the robot is not connected to a network, then the robot will not be able to perform version updates and other operations.
Bluetooth	You can set up a Bluetooth connection

Settings	Description
Settings	Description
Map	Management module for the robot's operating maps. You can switch between operating maps, select the return point, and configure other settings.
Volume	Adjust song volume, voice message volume, and key press volume.
Music library	Import music and manage the music on the device. Up to 20 music files can be imported onto the device.
Voice	Download the voice package configured on the cloud platform and select the voice package..
Speed	Sets the robot's traveling speed in different modes, including the individual' s traveling speed, return speed, and cruising speed, and turns off the robot' s Steady Mode.
Charging setting	Sets the automatic charging configuration. It needs to be used with the PUDU charging pile.
Calling function	Set calling settings, including PUDU beeper, Pudu 4G watch, Pudu Pager, etc.
Version update	If it is not the latest version, you can download the latest version and update it. Before updating, please ensure that the robot has at least 20% battery remaining, otherwise the update may fail.
About	Displays manufacturer service information, such as the official website information, robot operations guide, etc.
Debug	Debugs the robot parameters, for technical support engineers only. The Company will not bear any liability for issues arising from unauthorized operations.
Advanced Settings	Enable multiple trays for a single table, set delivery parameters, and other functions. Advanced settings are Advanced Robot Operations; please contact a technical support engineer to get the method of operation. The Company will not bear any liability for issues arising from unauthorized operations.

## Basic settings

In Basic Settings, you can adjust the screen brightness and select the device language.



## Network

In Network Settings, the device can be configured for a 4G network or wireless LAN. A device without a network connection cannot perform version updates.

## Bluetooth

The device's Bluetooth module can be enabled or turned off.

## Map

The robot can support the configuration of multiple maps, for use when the usage scenario changes or when the scenario route changes. When you switch maps, the Happy Delivery robot will automatically synchronize the destination information, docking location, and other configured information in the maps. Users can select a map and select a robot docking location based on the actual scenario.

Tap on the map management screen to access the robot Mapping tool software interface and create maps, edit maps, and more.

## Volume

In Volume Settings, you can adjust the robot's song volume, voice message volume, and key press volume. The specific meaning for each type of volume is as follows:

- Song volume: The volume of the songs and music played by the robot;



- Voice message volume: The volume of the voice messages played by the robot, including default voice messages and customized voice messages;
- Key press volume: The volume of the key press sound when operating the robot.

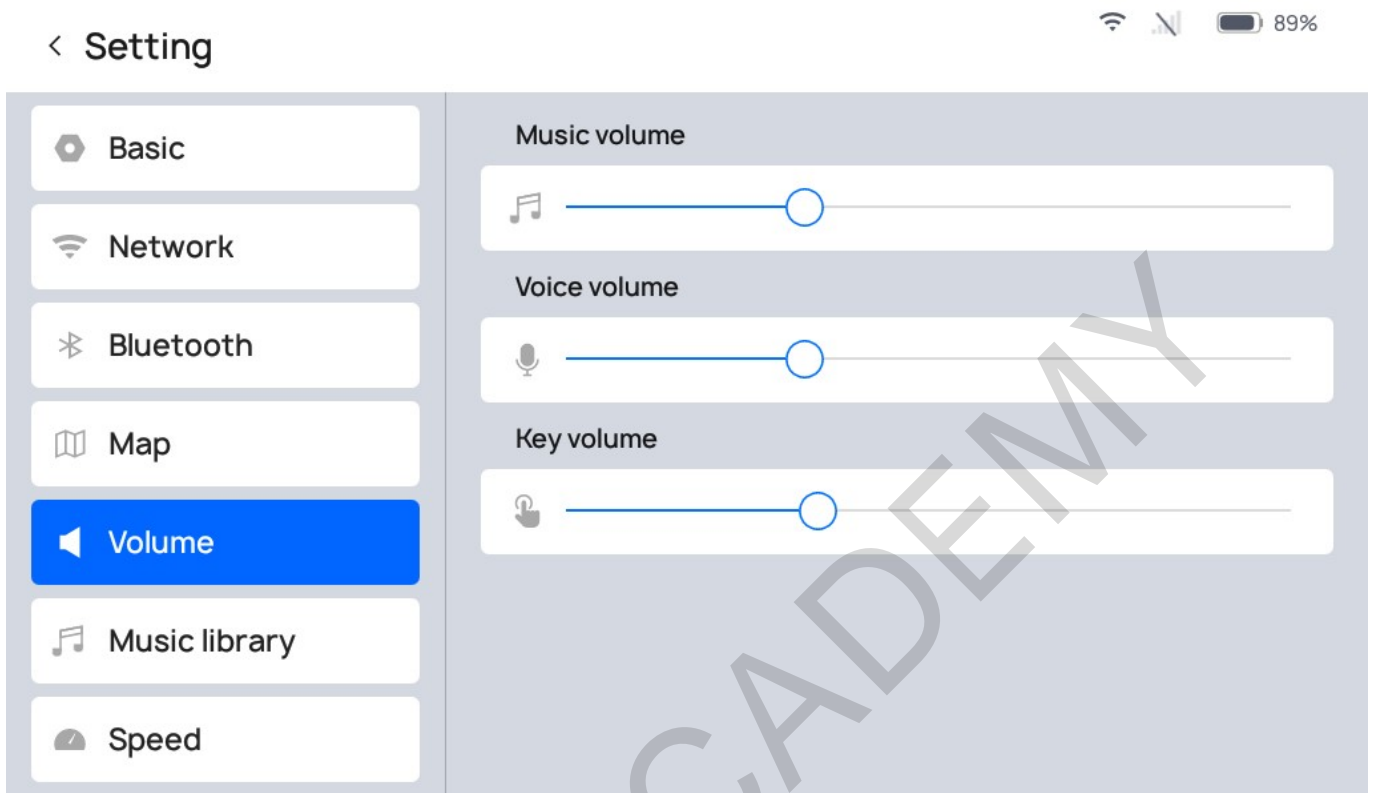

## Music Library

In the Music Library module, users can import music for the robot by connecting the robot to the same Wi-Fi as their phone and scanning the QR code in the "Import Music" module. Imported music files will be displayed in the "List of All Music." The robot can store up to 20 music files. Supported music file formats: MP3, WAV, FLAC, AAC, PCM, WMA, APE.

- You can test music by tapping the " " button to the right of the music file;
- By long pressing a song, the "Delete" button will pop up. Tap the button to delete music.

## Voice

In the voice module, you can download the voice package configured on the cloud platform or select a locally stored voice package.

- Select Voice Package: You can select a locally downloaded voice package, and once selected, the machine will play the chosen voice package.
- Download List: You can select the voice package which is authorized by the cloud platform for the robot.

# Speed

The robot's traveling speed, return speed, and cruising speed can be adjusted on the basis of the actual needs for use. The traveling speed, return speed, and cruising speed are defined as follows:

- Traveling speed: The speed at which the robot travels to the destination;
- Return speed: The speed at which the robot returns from any point to the docking location;
- Cruising speed: The speed at which the robot travels when acting as a patroller;

Range of speeds: 0.1m/s (0.33ft/s)~ 1.2m/s (3.93ft/s)

In addition, in order to ensure the smooth delivery of items, you can enable the "Steady

Mode" switch in the Speed Settings. Once the switch is enabled, a "" icon will appear on the screen in all modes. Tap this icon to enable Steady Mode. In Steady Mode, the robot runs more smoothly.

## Charging settings

In this section, you can set automatic charging configuration on your need.

### (1)The switch of automatic self-charging

If there is a charging pile set in the robot map, this switch will be turned on by default. When enabled, the low battery threshold of the robot can be set (the setting range is 5%~50%). When the battery is lower than this threshold, the robot will automatically go to the charging pile for charging..

### (2)Customize time slot for automatic recharging

The automatic charging time period of the robot can be customized, and the robot will only perform the recharging task in the set time period. There will be a time period of "00:00~23:59" in the machine by default. You can also click the "+" symbol to add the time period, and you can open/close each time period through the switch.

When multiple time periods are opened at the same time, the robot will perform automatic recharge if the current moment belongs to any of the open periods.

### (3)Select charging pile

If multiple charging pile points are set in the map, you can select the charging pile that the robot automatically charging here.

## Calling function

You can set calling settings, including PUDU beeper, Pudu 4G watch, Pudu Pager, etc.

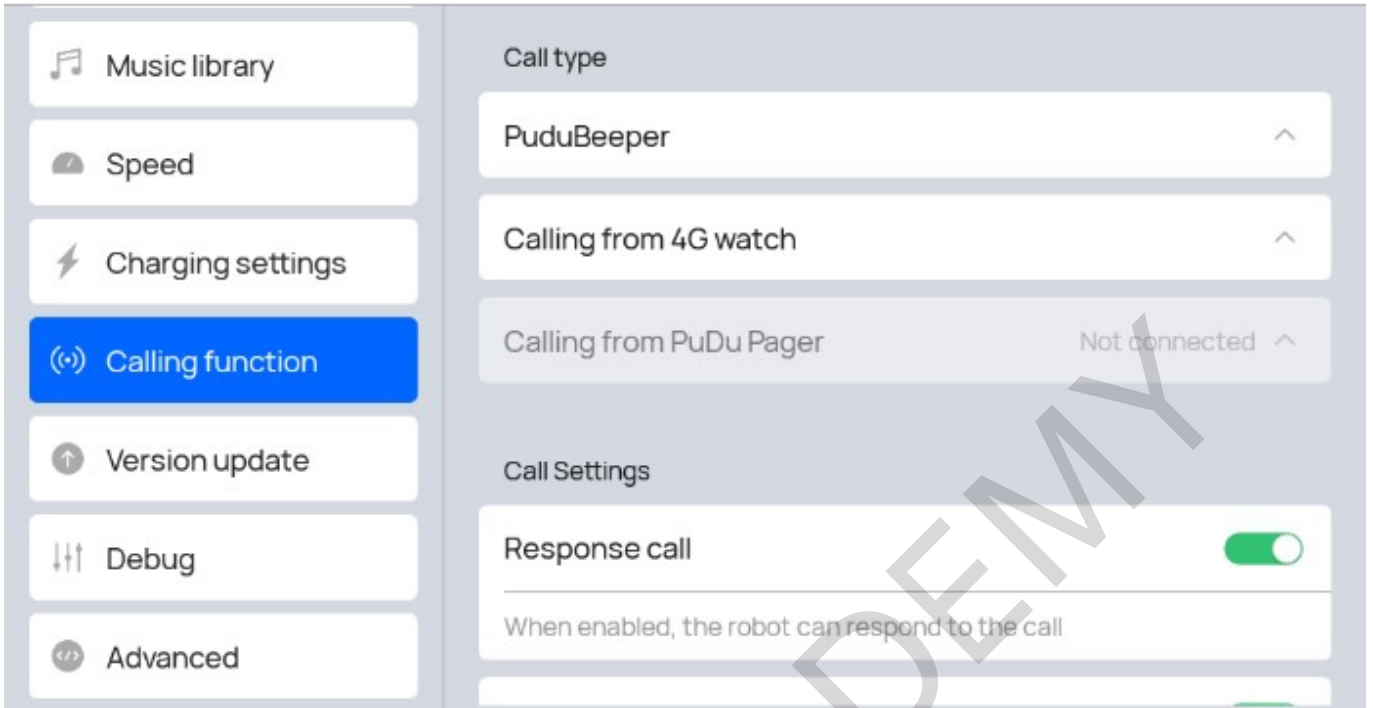

1. PuduBeeper

Pudu Beeper can be downloaded here. Click "Generate QR Code" and use PuduBeeper to scan the QR code to call the robot.

2. Calling from 4G watch

4G watch can be bound here. Click "Generate QR Code" and use Pudu 4G watch to scan the generated QR code to call the robot on the 4G watch.

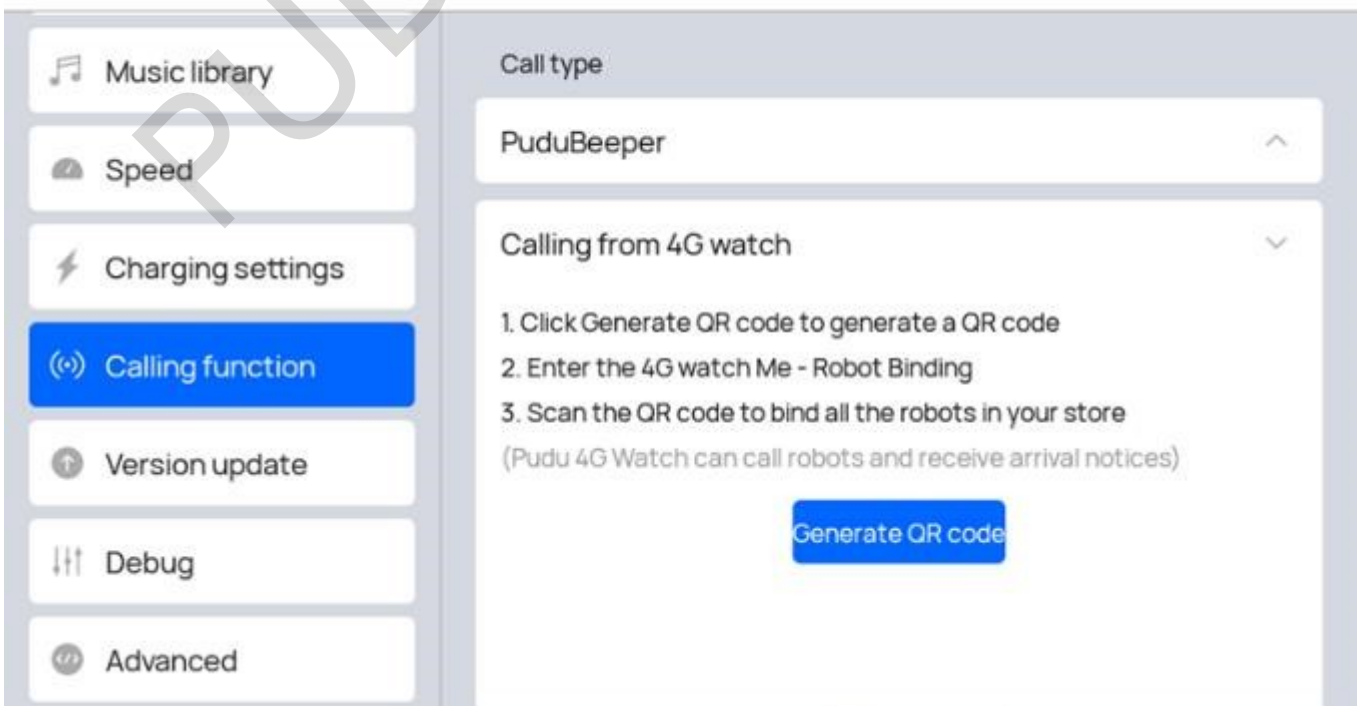

### 3. Calling from Pudu Pagar

Pudu Pager can be configured here. For specific deployment methods, please contact technical support.

### 4. Call Settings

There are other settings on Calling Function:

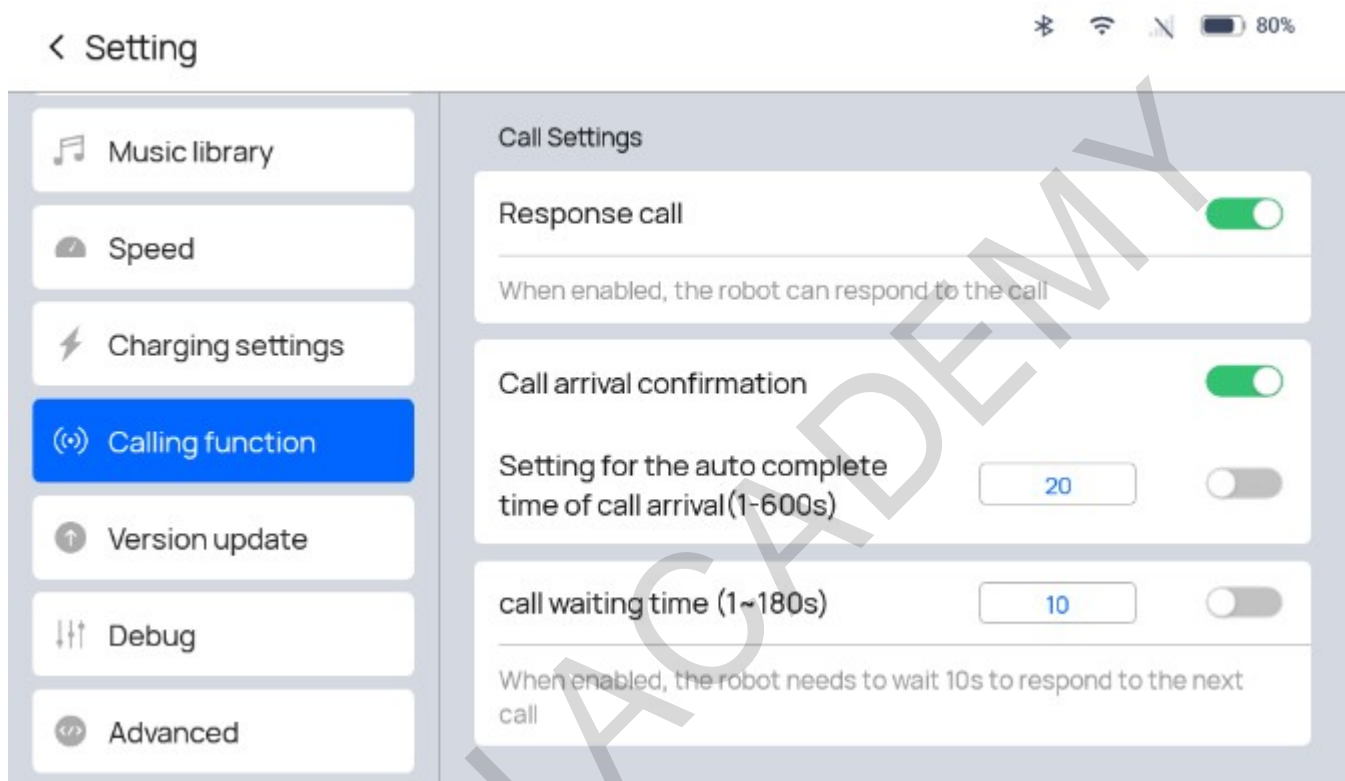

**Response call:** When enabled, the robot can respond to calls from Pudu Beeper and 4G Watch.

**Call arrival confirmation:** When enabled, you need to click robot manually to let it return home page, after the robot reaches it call point.

**Setting for the auto complete time of call arrival:** When enabled, After the robot reaches the point, it will start counting down based on the set time. After the countdown ends, the robot returns to the original page. In addition, if Call arrival confirmation is on, the robots will still remain on the call arrival page after the countdown ends.

**Call waiting time:** When enabled, the robot will start counting down based on the set time, and will only execute the call task after the countdown ends, after receiving a call task.

## Version Updates

When the robot is connected to the network, it can check whether there are version updates. If a new version of the robot software is available, there will be a red dot prompt next to "Version Update" as a reminder to perform the update.

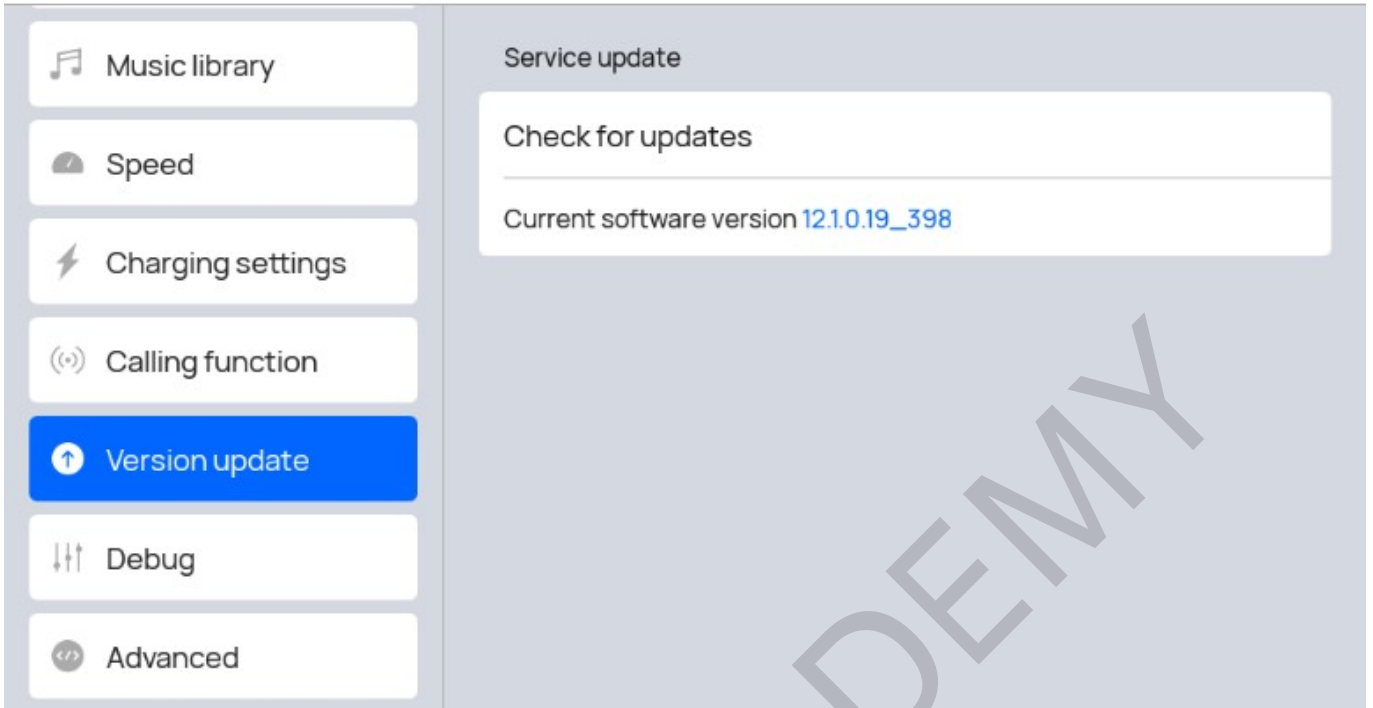

After tapping Update, the robot will download the installation package and a prompt for the download percentage prompt will appear. Once the download is complete for the installation package, the robot will automatically restart.



caution

When performing version updates, please ensure that the robot has at least 20% battery remaining.

Please do not manually turn off the robot while performing a version update..

## About

The About interface displays information such as the manufacturer's service hotline, name, official accounts, etc.

## Debug

The Debugging interface is provided for use by technical support to debug the device. Please do not use the Debugging interface yourself.

# Advanced Settings

The Advanced Settings are used to adjust the robot's advanced configurations, and a password must be entered for access.

Settings	Description
Task Parameter Settings	Set common parameters for each operating mode, including Automatic Return Time and Automatic Resume Time on Pause.
Settings	Description
Show emoji during delivery	Controls whether or not the robot displays emojis while executing tasks
High operating speed	Enables higher traveling speeds
Default input method	The default method for inputting robot destinations in all modes, including direct selection of locations and smart selection of locations
Select tray quantity	The number of trays in the robot schematic diagram on the left will be changed accordingly on the home page of each mode.
Path blocking settings	The behavior of robot can be configured, when it encounters obstacles.

Detailed Description:

## 1. Task Parameter Settings

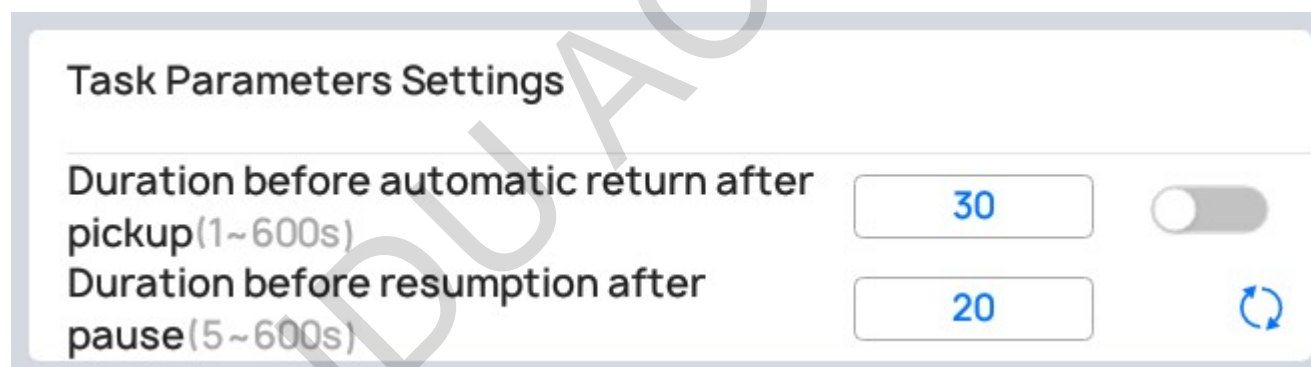

There are two items under the Task Parameter Settings:

Enable the right-most switch for "Automatic Return Time after Removing Items" and enter a number in the text box (input range of 1-600, default of "30," units: seconds) so that, after arriving at a destination, the robot will wait for the period of time input; once the time period ends, it will automatically complete the task.

For "Automatic Resume Time on Pause," enter a number in the right-hand text box (input range of 5-600, default is "20," units: seconds) so that the robot will switch to the pause interface if the screen is tapped while the robot is running. The device will then perform a countdown based on the duration set here, and once the countdown ends, it will automatically execute the next task.

## 2. Display emojis during delivery

### Show emoji during delivery



When enabled, only an emoji, not the table number, will be displayed during the task

When this function is turned on, only emojis are displayed on the delivery map, and the specific destination name is not displayed.

### 3. High operating speed

### High operating speed



When enabled, you can set a higher speed for the robot

When this function is enabled, adjustable speeds within the range of 1.0 m/s~1.2 m/s (0.33 ft/s-3.93 ft/s) are displayed in the Speed Settings.

### 4. Default input method

The default destination input method can be selected for each mode. There are two input methods:

- Direct Destination Selection: The destination list is in a tiled display in the window on the right side of the interface, and you manually and directly find and select the table number.
- Smart Destination Search: The robot automatically extracts the first character of all destination names for display, and gradually filters out the destinations by screening the characters as you proceed.

On the "Settings" - "Advanced Settings" page, under "Default Input Method," you can select the default input method.

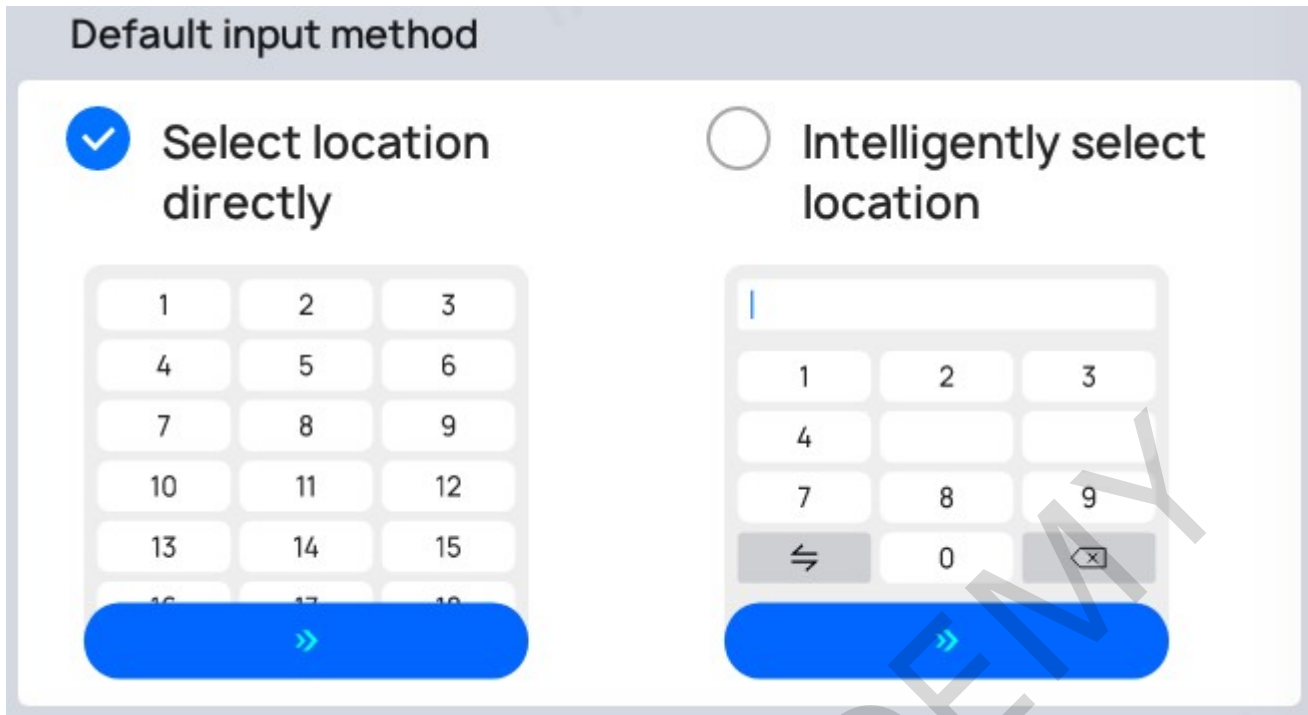

Each time you access the main page for each mode, the destination input method defaults to the input method selected in the Advanced Settings. Of course, you can modify the input method for

selecting a delivery destination by tapping on the "🔍" button on the right side of the Delivery Mode home page.

5. Select tray quantity

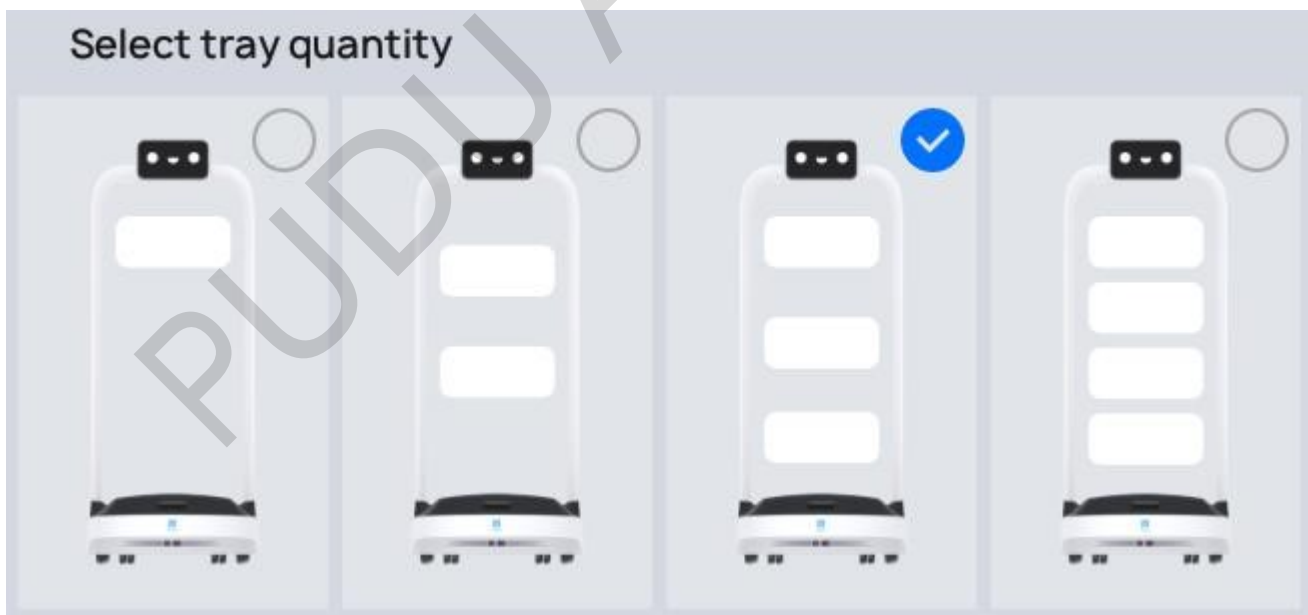

The number of trays can be selected according to the actual number of pallets actually assembled by the current robot. The selection range is 1 to 4. After modification, the number of trays in the robot schematic diagram on the left will be changed accordingly on the home page of each mode.

6. Path blocking Settings

When "Path Blocking Setting" is enabled, if the robot encounters continuous obstruction during the



task, it will trigger path replanning.

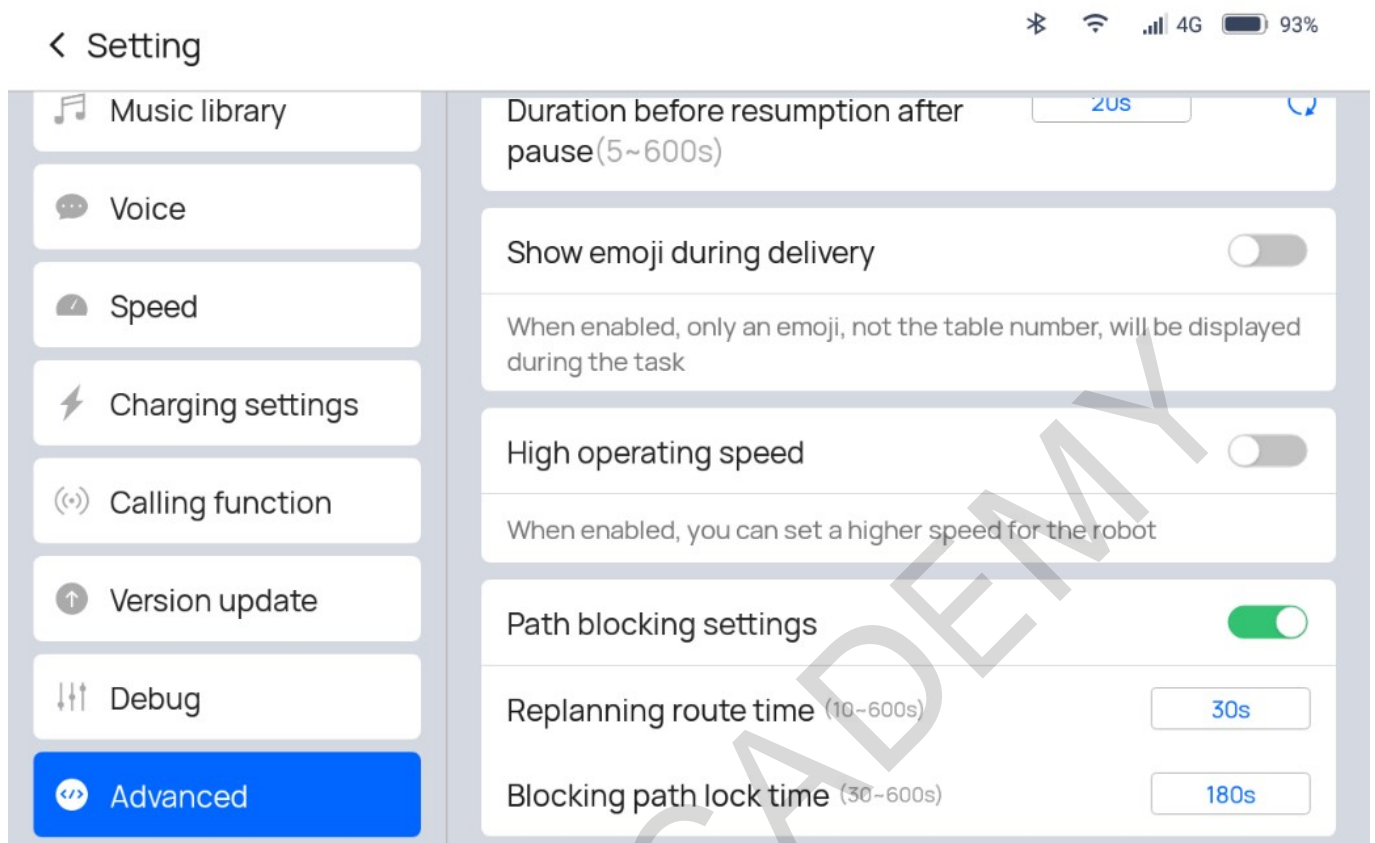

- Replanning route time: When the robot continues to avoid obstacles for the set time, path replanning is triggered, and other paths on the map are selected to attempt to reach the target point. The time setting range is 10~600 seconds.
- Blocked Path Locking Time: When the robot triggers path re-planning, the current blocked road will be marked as "unavailable". After the set time in this parameter, it will automatically be restored to "available". The time setting range is 30~600 seconds.

## Tray Adjustment

The position of PuduBot 2's trays can be adjusted according to the actual situation, with a total of 7 optional positions: During tray adjustment, the screen printing numbers (from back to front) on the tray's fixture should be the same as those on the robot (from top to bottom) so that all trays' outer edges are vertically aligned.

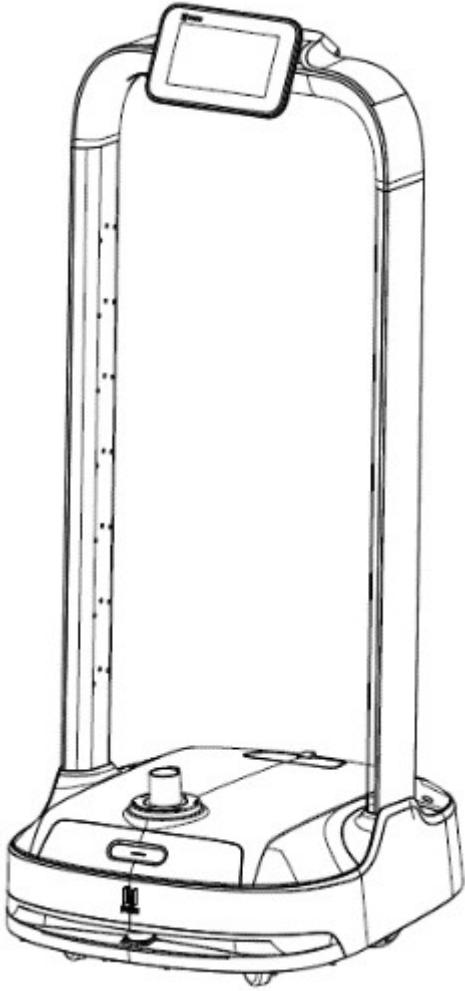

PUDU ACADEMY

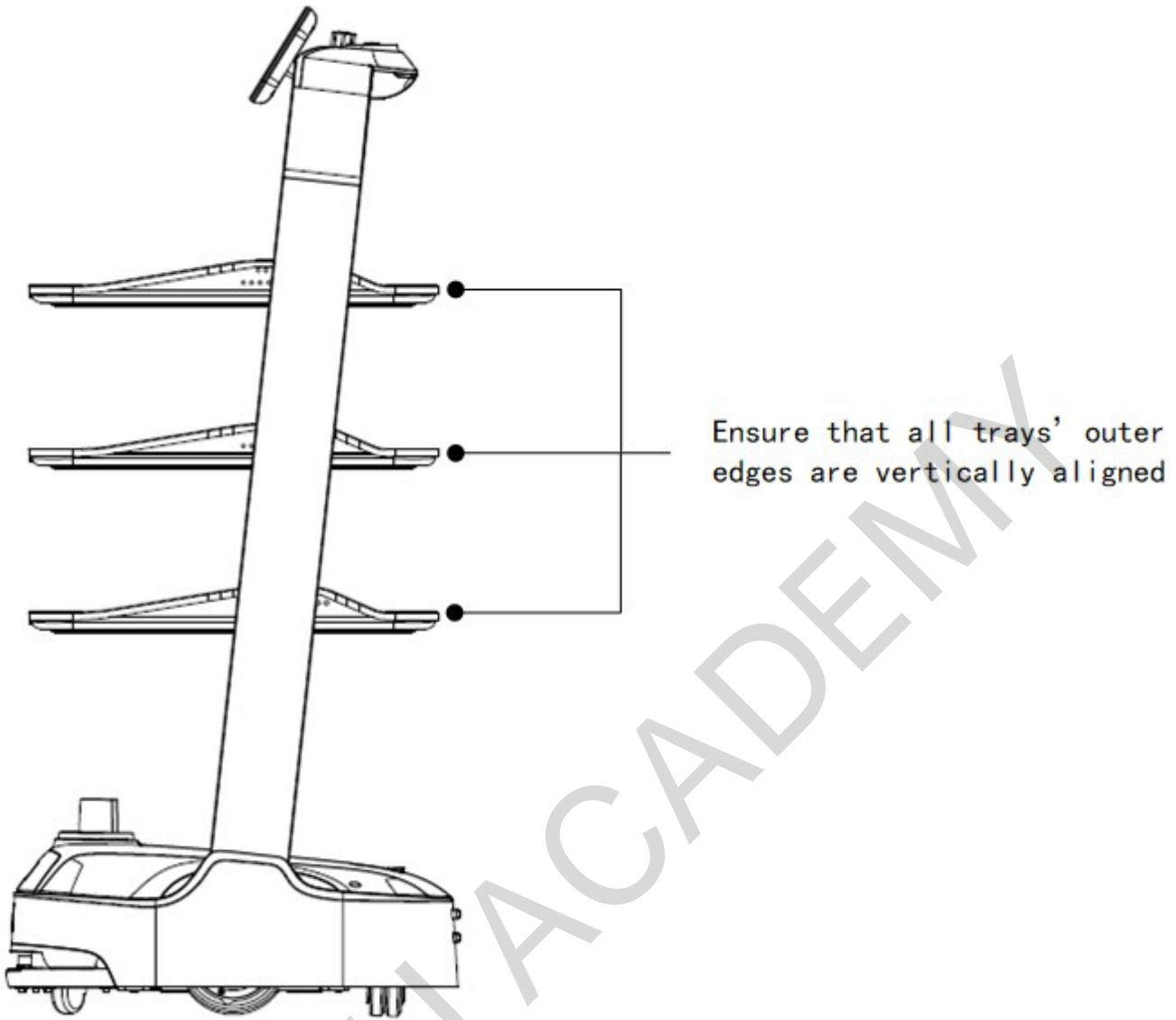

## Docking Instructions

PuduBot 2 supports three docking modes. In actual scenarios where multiple robots cooperate, users can select any docking mode during mapping. This section only covers the description of the three docking modes. For details about mapping, please contact our technical engineers.

Three docking modes:

- One-to-one Docking mode: Each robot has its fixed pickup location (docking location).
- Free Docking mode: Set multiple pickup locations (docking locations) for the robot to dock by priority, i.e., the robot chooses the nearest pickup location for docking.
- Waiting mode: Set temporary docking location. When the robot has no task and there's no vacancy at the pickup locations (docking locations), the robot docks at the temporary docking location. Once a vacancy appears at a pickup location (docking location), the robot automatically goes there for docking.