

AZHS15DCXXA

GE Zoneline® Heat Pump Unit with Corrosion Protection, 230/208 Volt

Features & Benefits

- Cooling Capacity - 15,100/14,700
- Energy Efficiency - 10.4/10.4 EER
- Dehumidification - 4.1 Pints/Hour
- Heat Pump Capacity - 13,500/13,300 BTU
- Heat Pump Efficiency - 3.3/3.4 COP
- Heat Pump Down to 25°F with Reverse Cycle Defrost
- Indoor Fan CFM (High/Low) - 495/330
- Electronic Touch Controls with LED Display
- Quiet Operation - Baked-On Mastic Sound Barrier, Cross Flow Blower and Two DC Fan Motors Create Less Noise to Ensure Comfort
- Corrosion Resistant - Extends Life of the Unit in Sea Coast Areas/Corrosive Environments
- SMC Base Pan and Bulkhead - No Rusting and Helps Block Noise
- Heat & Freeze Sentinels - Keeps the Room from Over-Heating or Freezing
- Electronic Temperature Limiting - Prevents Expensive Over-Cooling or Over-Heating of the Room
- Fresh Air Vent CFM (Fully Open High Fan) - 44*
- R 454B Refrigerant

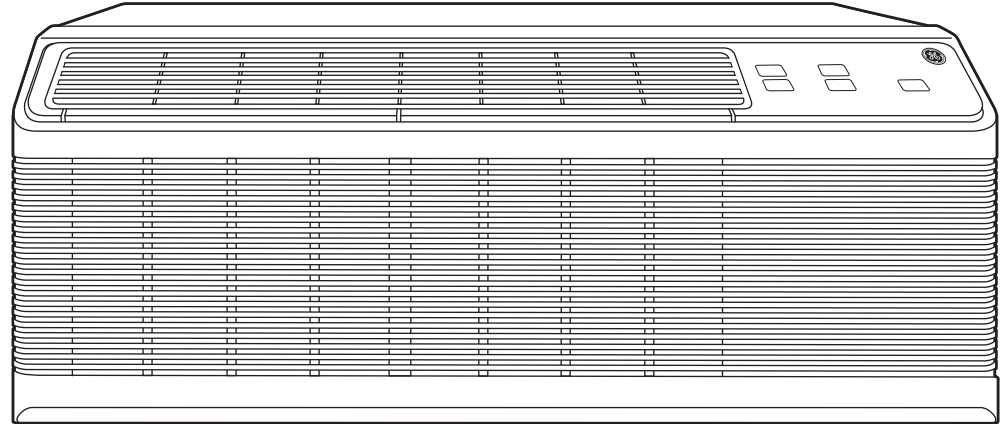

*When Using the RAKVENT1 Kit

Projected Specifications. Subject to Change Without Notice.



GE APPLIANCES

For more information please visit our website at zoneline.com or message Hospitality.Direct@geappliances.com.

Specification Revised 2/24

AZHS15DCXXA

GE Zonline® Heat Pump Unit with Corrosion Protection, 230/208 Volt

Dimensions and Installation Information (In Inches)

Electrical Wiring

All wiring, including installation of receptacle, must be made in accordance with national and local electrical codes and regulations. Note: Aluminum wiring may pose special problems – consult a qualified electrician.

Grille Options

Stamped Aluminum Grille – RAG60 Exterior Architectural Louvers
Durable Polycarbonate: RAG42PB (Beige), RAG42PM (Maple), RAG42PD (Dark Brown) Extruded Aluminum Architectural Grille – RAG42AA

Retrofit Kits

RAK40 – Deflector Kit to adapt chassis for use with non-GE exterior louvered grilles.

Ducted Applications

AZHS, AZES, & AZVS Series without make-up air can be used with ductwork to heat or cool more than one room. RAK6053 Duct Adapter is applied to the top of case over the air discharge. RAK601B Duct Extension is applied to right or left of adapter. Locally fabricated ductwork may be added to extend to maximum recommended straight distance of 15 feet in one direction.

Electrical Connection

230/208 volt units may be plugged into a receptacle. See Architects and Engineers Design Data Manual for electrical connection information including use of sub-base for direct connected units. Installation must comply with national and local electrical codes and regulations. Power connection kits are required on all Zonline chassis.

Wall Sleeve Dimensions

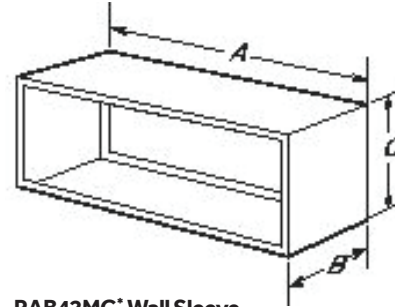

RAB42MG* Wall Sleeve

Heavy-gauge steel, 4 pc design with insulation. A-42", B-13-3/4", C-16" Also available in 16", 18", 20" and 24" depths

RAB42PG Wall Sleeve

4 pc fiberglass reinforced polyester compound with stainless steel locking components. A-42", B-14", C-16"

Maximum Cord Extension

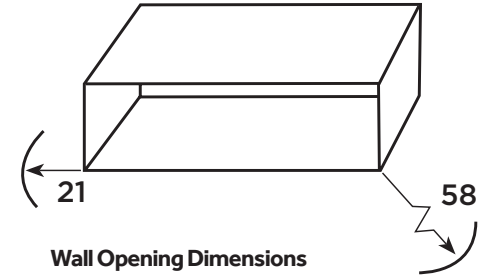

Wall Opening Dimensions

Add 1/4" to A and C dimensions for all cut-outs.
16-1/4" Min. H x 42-1/4" Min. W

AZHS, AZES, AZVS Heater KW						
230/208 Volt	Line Cord (P), Direct (D) and Sub-Base Connected Units					
	7K/9K			12K/15K		
Power Connection Kit	RAK315P RAK315D* RAK204D15C*	RAK320P RAK320D* RAK204D20C*	RAK330P RAK330D* RAK204D30C*	RAK315P RAK315D* RAK204D15C*	RAK320P RAK320D* RAK204D20C*	RAK330P RAK330D* RAK204D30C*
Total Watts	2410/1990	3420/2830	4830/3990	2430/2020	3450/2860	4860/4020
Heater Watts	2400/1960	3400/2780	4800/3930	2400/1960	3400/2780	4800/3930
Heater BTU	8100/6600	11600/9400	16300/13400	8100/6600	11600/9400	16300/13400
Total Amps	10.5/9.6	14.9/13.6	21.0/19.2	10.6/9.7	15.1/13.8	21.2/19.3
(MCA)	15	20	30	15	20	30
Recommended Protective Device (MOCP)	15 amp Time-Delay Fuse or Breaker	20 amp Time-Delay Fuse or Breaker	30 amp Time-Delay Fuse or Breaker	15 amp Time-Delay Fuse or Breaker	20 amp Time-Delay Fuse or Breaker	30 amp Time-Delay Fuse or Breaker

*Per the NEC, use of this connection kit requires the purchase and use of the RAK4002D Junction Box.



GE APPLIANCES

For more information please visit our website at zonline.com or message Hospitality.Direct@geappliances.com.

Specification Revised 2/24