

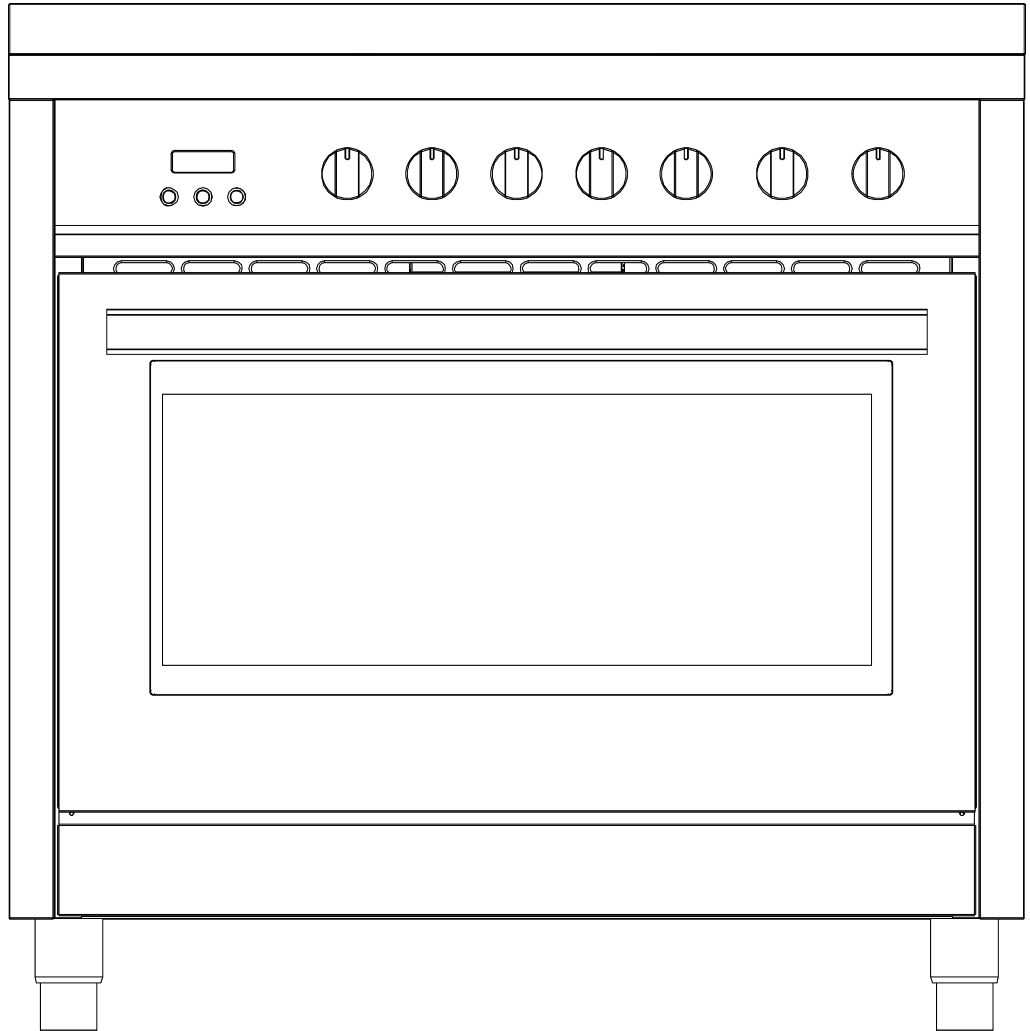

ELECTRIC RANGE

Freestanding Range Vitroceramic Cooktop Electric Oven



User Manual & Installation Instructions

IMPORTANT SAFETY INSTRUCTIONS

Carefully read the important information regarding installation, safety and maintenance.
Keep these instructions for future reference.

Intended for household use. Unit must be kept clear of combustibles at all times.



Table of Contents

Table of Contents	2
Safety Requirements	3
Parts Supplied	9
Ventilation Requirements.....	10
Electrical Requirements.....	13
Advance Preparation	14
Tools and Parts	14
Range Dimensions.....	14
Unpack Range	16
Install Leveling Feet and Back Panel	16
Install Anti-Tip Bracket	17
Installation Instructions	19
Electrical Connection	19
Surface Cooking	22
Location of the Burners	22
Description of Symbols	22
Setting Surface Controls	23
Surface Cooking Utensils	24
Oven Cooking	25
Setting Oven Clock and Timer	25
Setting Oven Controls	26
Cooking Instructions.....	28
Care and Cleaning.....	29
Solutions to Common Problems	33
Warranty	34



Safety Requirements



IMPORTANT SAFETY NOTICE

READ ALL INSTRUCTION BEFORE INSTALLING AND OPERATING THIS APPLIANCE

We have provided many important safety messages in this manual and on your appliance. Always read and obey all safety messages.



This is the safety alert symbol.

This symbol alerts you to potential hazards that can kill or hurt you and others.

All safety messages will follow the safety alert symbol and either the word “DANGER” or “WARNING.”

These words mean:

⚠ DANGER

You can be killed or seriously injured if you don't immediately follow instructions.

⚠ WARNING

You can be killed or seriously injured if you don't follow instructions.

All safety messages will tell you what the potential hazard is, how to reduce the chance of injury, and what can happen if the instructions are not followed.

- **⚠** Remove all tape and packaging before using the appliance. Never allow children to play with packaging material. Do not remove the model/serial plate attached to the appliance.





- **⚠** Be sure your appliance is properly installed and grounded by a QUALIFIED TECHNICIAN in accordance with the National Fuel Gas Code ANSI Z223.1—latest edition in the United States, or in Canada CAN/CGA B149.1, and CAN/CGA B149.2, and the National Electrical Code ANSI/NFPA No. 70—latest edition in United States, or in Canada CSA Standard C22.1, Canadian Electrical Code, Part 1, and local code requirements. Install only as per installation instructions provided in the literature package for this appliance.

⚠ WARNING

If the information in this manual is not followed exactly, a fire or explosion may result causing property damage, personal injury or death.

- **⚠ FOR YOUR SAFETY:**

- Do not store or use gasoline or other flammable vapors and liquids in the vicinity of this or any other appliance.
- **⚠** Installation and service must be performed by a qualified installer. Ask your dealer to recommend a qualified technician and an authorized repair service. Know how to disconnect the electrical power to the appliance at the circuit breaker or fuse box in case of an emergency.
- **⚠** Do not repair or replace any part of the appliance unless specifically recommended in the manuals. All other servicing should be done only by a qualified technician. This may reduce the risk of personal injury and damage to the appliance.
- **⚠** Proper Installation – The range, when installed, must be electrically grounded in accordance with local codes or, in the absence of local codes, with the *National Electrical Code, ANSI/NFPA 70*. In Canada, the range must be electrically grounded in accordance with Canadian Electrical Code. Be sure the range is properly installed and grounded by a qualified technician.
- **⚠** Disconnect power before servicing.
- **⚠** Never modify or alter the construction of the appliance by removing panels, wire covers or any other part of the product.
- **⚠** Injuries may result from the misuse of appliance doors or drawers such as stepping, leaning, or sitting on the doors or drawers.

-  Overhead range hoods, which operate by blowing a downward air flow on to a range, shall not be used in conjunction with gas ranges other than when the hood and range have been designed, tested and listed by an independent test laboratory for use in combination with each other.
-  Ensure that the room is well ventilated by keeping the air intakes open and in good working order or by installing an extractor hood with discharge pipe. If the appliance is used intensively for a long time the effectiveness of the ventilation will have to be increased, for example by opening a window or increasing the power of any electric extractor fan.
-  Flammable materials should not be stored on the appliance or near surface units. This includes paper, plastic and cloth items, such as cookbooks, plastic ware and towels, as well as flammable liquids. Do not store explosives, such as aerosol cans, on or near the appliance. Flammable materials may explode and result in fire or property damage.
-  Maintenance – Keep range area clear and free from combustible materials, gasoline, and other flammable vapors and liquids.
-  Storage in or on the Range – Flammable materials should not be stored in an oven or near surface units.

DANGER

Do not store items of interest to children in the cabinets above the appliance or on the backguard of a range. Children should not be left alone or unattended in the area where appliance is in use. Do not allow children to climb or play around the appliance. They should never be allowed to sit or stand on any part of the appliance. Children climbing on the appliance to reach items could be seriously injured.

-  **DO NOT TOUCH THE COOKING SURFACE, THE BURNERS, GRATES OR ANY AREAS NEAR THEM.** Surface burners or appliance may be hot even though flames are not visible. Areas near surface burners or appliance may become hot enough to cause burns. During and after use, do not touch, or let clothing or other flammable materials touch these areas until they have had sufficient time to cool.

-  Do not wear loose-fitting or hanging garments while using the appliance. Do not let clothing or other flammable materials contact hot surfaces.

-  Smother grease fires with a pan lid, or use baking soda, a dry chemical or foam-type extinguisher.

-  Use an extinguisher **ONLY** if:
 - You know you have a Class A, B, C extinguisher, and you already know how to operate it.
 - The fire is small and contained in the area where it is started.
 - The fire department is being called.
 - You can fight the fire with your back to an exit.

-  When heating fat or grease, watch it closely. Fat or grease may catch fire if allowed to become too hot.







-  Use only dry potholders. Moist or damp potholders on hot surfaces may result in burns from steam. Do not let potholders touch hot heating elements, the flame or burners. Do not use a towel or other bulky cloth instead of a potholder.

-  Do not heat unopened food containers. Buildup of pressure may cause the container to burst and result in injury.

-  Stepping, leaning or sitting on this appliance can result in serious injuries and also cause damage to the appliance.

-  Never use this appliance as a space heater to heat or warm the room. Doing so may result in carbon monoxide poisoning and overheating of the oven.

-  Know which knob controls which surface burner. Visually check that the burner has lit. Then adjust the flame so it does not extend beyond the edge of the utensil.

-  Clean the appliance regularly to keep all parts free of grease that could catch fire. Exhaust fan ventilation hoods and grease filters should be kept clean. Do not allow grease to accumulate on hood or filter. Greasy deposits in the fan could catch fire. When cooking food turn the hood, fan on. Refer to hood manufacturer's instructions for cleaning.
-  Utensil handles should be turned inward and not extend over adjacent surface burners. To reduce the risk of burns, ignition of flammable materials, and spillage due to unintentional contact with the utensil, the handle of the utensil should be positioned so that it is turned inward, and does not extend over adjacent surface burners.
-  Never leave surface burners unattended at high heat settings. Boil overs cause smoke and greasy spillovers that may ignite, or a pan that has boiled dry may melt.
-  Do not use aluminum foil to line any part of the appliance. Use aluminum foil only to cover food during cooking. Improper installation of these liners may result in risk of electric shock or fire.
-  Only certain types of glass, glass/ceramic, ceramic, earthenware, or other glazed utensils are suitable for appliance service without breaking due to the sudden change in temperature. Check the manufacturer's recommendations for appliance use.
-  Do not use decorative surface burner covers. If a burner is accidentally turned on, the decorative cover will become hot and possibly melt. You will not be able to see that the burner is on. Burns will occur if the hot covers are touched. Damage may also be done to the range or burners because the covers may cause overheating. Air will be blocked from the burner and cause combustion problems.
-  Use the proper pan sizes. This appliance is equipped with surface units of different sizes. Select utensils having flat bottoms large enough to cover the surface unit. The use of undersized utensils will expose a portion of the surface heating unit to direct contact and may result in ignition of clothing. Proper relationship of utensil to the surface unit will also improve efficiency.

⚠ WARNING

TO REDUCE THE RISK OF TIPPING OF THE RANGE, THE RANGE MUST BE SECURED BY PROPERLY INSTALLED ANTI-TIP DEVICES. TO CHECK IF THE DEVICES ARE INSTALLED PROPERLY, SLIDE RANGE FORWARD, LOOK FOR ANTI-TIP BRACKET SECURELY ATTACHED TO FLOOR OR WALL, AND SLIDE RANGE BACK SO REAR RANGE FOOT IS UNDER ANTI-TIP BRACKET.

- **⚠** The range will not tip during normal use. However, the range can tip if you apply too much force or weight to the open door without having the anti-tip bracket fastened down properly.

⚠ DANGER

TIP OVER HAZARD



A child or adult can tip the range and be killed.

Connect anti-tip bracket to rear range foot.

Reconnect the anti-tip bracket, if the range is moved.

See the installation instructions for details.

Failure to follow these instructions can result in death or serious burns to children and adults.

Parts Supplied



1 × Optional Backsplash
4 + 1 Screws



7 × Knobs



4 × Feet

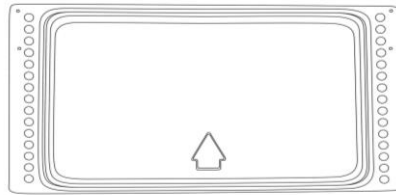

1 × Grill Set (Basin + Anti-Splash)

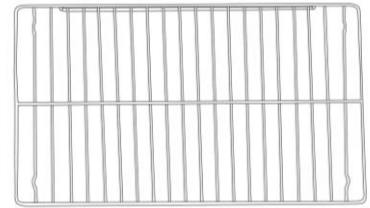

2 × Oven Racks

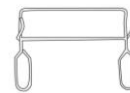

1 × Rack Puller

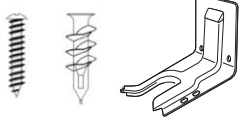









1 × Anti-Tip Bracket
2 × Screws and Anchors

Ventilation Requirements

⚠ WARNING

The range should have proper ventilation in order to keep the unit operating properly and maintain the temperature of immediate surroundings within safe limits. Check your local building codes as they may vary from the general rules outlined in this guide. It is recommended that a hood be installed above the range that is rated no less than 400 CFM. This will provide adequate ventilation for this range. Mounting distance of your ventilation is outlined by the manufacturer of your hood.

- **⚠** Observe all governing codes and ordinances. Do not obstruct flow of combustion and ventilation air.
- **⚠** It is the installer's responsibility to comply with installation clearances specified on the model/serial rating plate.
- **⚠** The range should be located for convenient use in the kitchen.
- **⚠** Recessed installations must provide complete enclosure of the sides and rear of the range.
- **⚠** To eliminate the risk of burns or fire by reaching over heated surface units, cabinet storage space located above the surface units should be avoided. If cabinet storage is to be provided, the risk can be reduced by installing a range hood or microwave hood combination with minimum 400 CFM that projects horizontally a minimum of 5" (12.7 cm) beyond the bottom of the cabinets. (See Figure 1)
- **⚠** If a range hood is installed above the appliance, maintain a 30" minimum clearance between cooking surface and bottom of range hood. The range hood must be connected directly to flues or to the outside. (See Figure 1)

-  Avoid placing cabinetry directly above the appliance when possible. If cabinetry is used above the cooking surface, use cabinets no more than 13" deep. Make sure the wall coverings, countertop and cabinets around the appliance can withstand heat up to 200° F (93°C) generated by the appliance. (See Figure 1)
-  Cabinet opening dimensions that are shown must be used. Given dimensions are minimum clearances. (See Figure 1)
-  Working areas adjacent to the range should have 18" minimum clearance between countertop and cabinet bottom. (See Figure 1)
-  All openings in the wall or floor where range is to be installed must be sealed.
-  Contact a qualified floor covering installer to check that the floor covering can withstand at least 200°F (93°C).
-  Use an insulated pad or ¼" (0.64 cm) plywood under range if installing range over carpeting.
-  The floor anti-tip bracket must be installed. To install the anti-tip bracket shipped with the range, see "Install Anti-Tip Bracket" section.
-  Grounded electrical supply is required. See "Electrical Requirements" section.

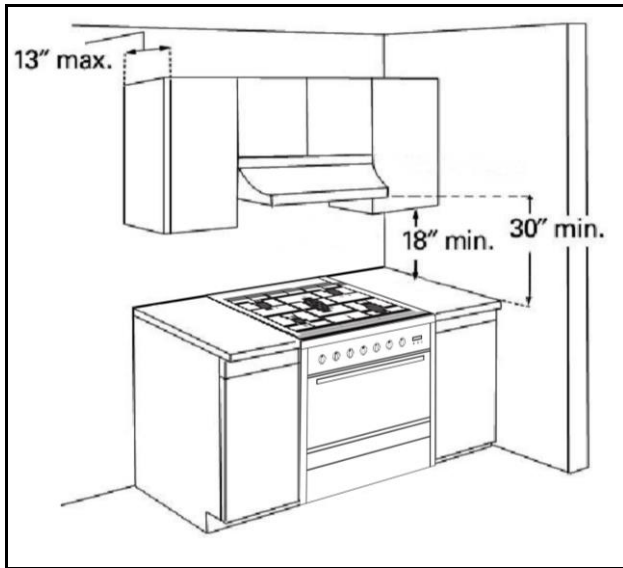

Figure 1

⚠ WARNING

To avoid damage to your cabinets, check with your builder or cabinet supplier to make sure that the materials used will not discolor, delaminate or sustain other damage. This oven has been designed in accordance with the requirements of UL and CSA International and complies with the maximum allowable wood cabinet temperatures of 194°F (90°C).

MOBILE HOME – ADDITIONAL INSTALLATION REQUIREMENTS

- **⚠** The installation of this range must conform to the Manufactured Home Construction and Safety Standard, Title 24 CFR, Part 3280 (formerly the Federal Standard for Mobile Home Construction and Safety, Title 24, HUD Part 280). When such standard is not applicable, use the Standard for Manufactured Home Installations, ANSI A225.1/NFPA 501A or with local codes.

In Canada, the installation of this range must conform with the current standards CAN/CSA-A240-latest edition, or with local codes.

MOBILE HOME INSTALLATIONS REQUIRE:

- **⚠** When this range is installed in a mobile home, it must be secured to the floor during transit. Any method of securing the range is adequate as long as it conforms to the standards listed above.

Electrical Requirements

⚠ WARNING



Electrical Shock Hazard

Do not use an extension cord.

Failure to follow these instructions can result in death, fire, or electrical shock.

- **⚠** Any additions, changes or conversions required in order for this appliance to satisfactorily meet the application needs must be made by a qualified service technician in accordance with the manufacturer's instructions and all codes and requirements of the authority having jurisdiction. Failure to follow the instructions could result in serious injury or property damage. The qualified agency performing this work assumes responsibility for the conversion.

- **⚠** This appliance is not supplied with a plug. If you wish to install this appliance with a plug, it must be installed by a qualified service technician. The plug must be a 4-prong, 3-phase plug that is designed specifically for freestanding ranges.

- **⚠** This appliance can be installed directly to the main (without a plug). To do so, follow

instructions in the "Electrical Connection" section. If you wish to install this appliance directly to the main (without a plug), it must be installed by a qualified service technician.

- **⚠ DO NOT** operate this appliance using a 2-prong adapter or an extension cord. If a 2-prong wall receptacle is the only available outlet, it is the personal responsibility of the consumer to have it replaced with a properly grounded 4-prong wall receptacle installed by a qualified electrician.

- **⚠** Severe shock, or damage to the range may occur if the range is not installed by a qualified installer or electrician.

- **⚠** It is **220-240V/50-60Hz**. With recommendation to connect to a **50 Amp** power supply.

- **⚠** Total Input Power is 11.7kw (48.75A). A dedicated circuit, protected by a minimum 50 amp time delay fuse or circuit breaker is required.

- **⚠** For personal safety, the appliance must be properly grounded.

- **⚠** See the "Installation Instructions" packaged with this appliance for complete installation and grounding instructions.

Advance Preparation

Tools and Parts

Gather the required tools and parts before starting installation.

Read and follow the instructions provided with any tools listed here.

- Tape measure
- Phillips screwdriver
- Flat blade screwdriver
- 1/8" flat blade screwdriver
- Level
- Hand or electric drill
- Wrench or pliers
- 1/8" (3.2 mm) drill bit (for wood floors)
- Marker or pencil
- 3/16" (4.8 mm) carbide-tipped masonry drill bit (for concrete/ceramic floors)

PARTS SUPPLIED:

Check that all parts are included.

- 3 - Oven racks
- 1 Anti-tip brackets
- 2 plastic anchors
- 2 screws

The anti-tip bracket must be securely mounted to the floor. Thickness of flooring may require longer screws to anchor bracket to subfloor.

PARTS NEEDED

Check local codes. Check existing electrical supply. See "Electrical Requirements" section.

Range Dimensions

•  Avoid placing cabinetry directly above the appliance when possible. If cabinetry is used above the cooking surface, use cabinets no more than 13" deep. Make sure the wall coverings, countertop and cabinets around the appliance can withstand heat up to 200° F (93°C) generated by the appliance. (See Figures 1 and 2)

•  Cabinet opening dimensions that are shown must be used. Given dimensions are minimum clearances. (See Figures 1 and 2)

- Working areas adjacent to the range should have 18" minimum clearance between countertop and cabinet bottom. (See Figures 1 and 2)

Figure 2

Note: This height measurement does not include leveling feet.

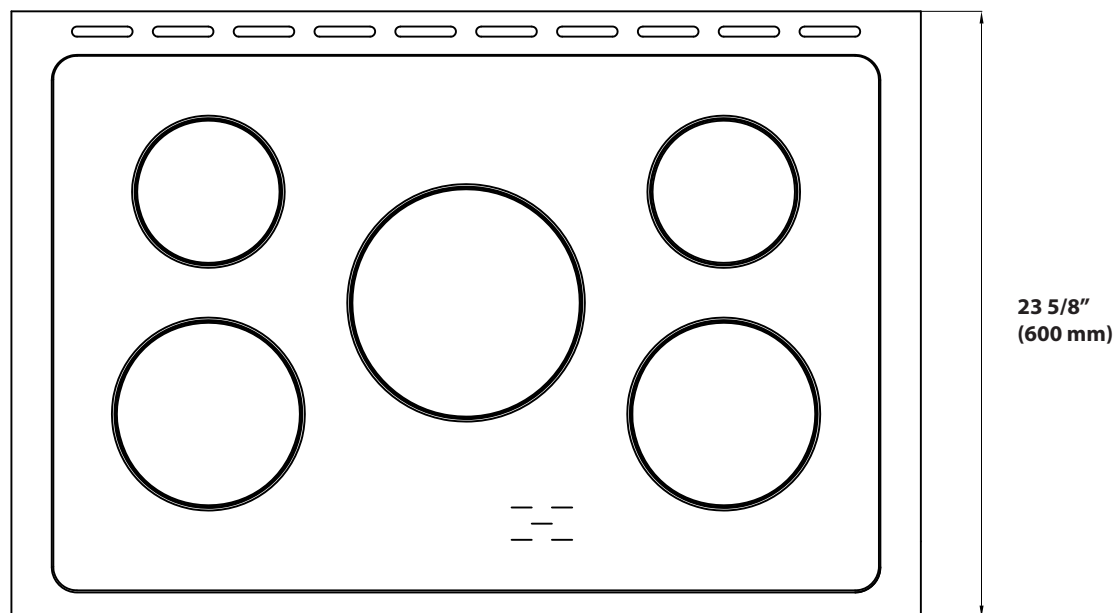
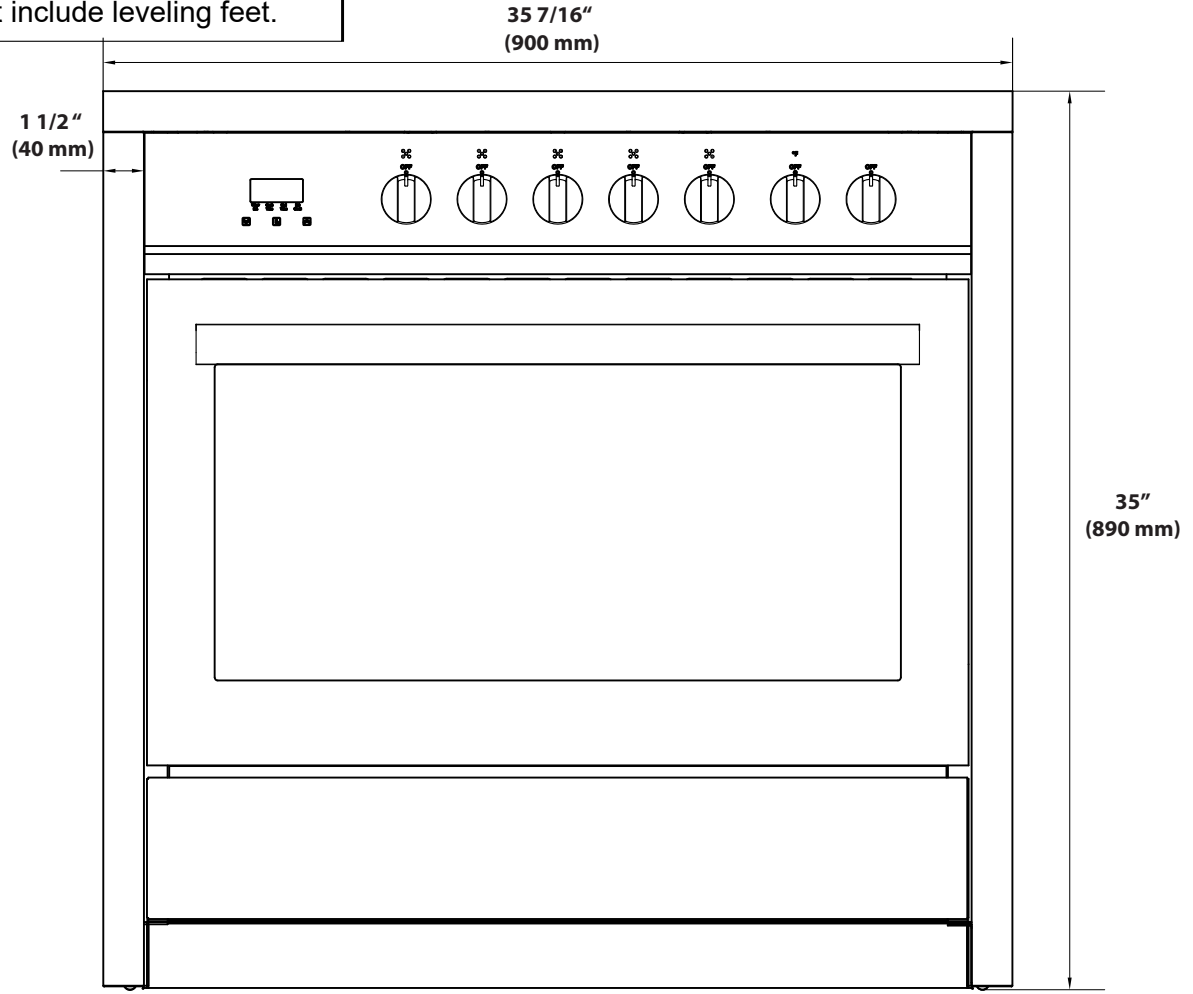

Unpack Range

Install Leveling Feet and Back Panel

⚠ WARNING

Excessive Weight Hazard

Tip Over Hazard

A child or adult can tip the range and be killed.

Use two or more people to move and install range.

Failure to follow these instructions can result in death or serious burns to children and adults.

1. Remove shipping materials from the range.
DO NOT remove protective film covering the appliance. DO NOT remove tape securing the drawer.
2. Remove oven racks and parts package from inside oven.
3. Place range on its back; take four (4) L-shaped cardboard corners from the carton. Stack one cardboard corner on top of another. Repeat with the other 2 corners.
4. Place the four (4) L-shaped cardboard corners lengthwise on the floor behind the range to support the range when it is laid on its back.
5. Using 2 or more people firmly grasp the range and gently lay it on its back on the cardboard corners.
6. Install the leveling feet one at a time. The leveling feet can be found in one of the boxes that was inside the oven.
7. Place cardboard or hardboard in front of range. Using 2 or more people, stand range back up onto cardboard or hardboard.
8. Remove the protective film covering the appliance. Remove tape securing the drawer.
9. The stainless steel back panel can now be installed. Align backsplash holes with holes at the edge of the stovetop, which extends past the back of the oven.
10. With one person holding the backsplash and working from underneath the extended rear edge, insert screws through the bottom of the backsplash. Tighten completely.
11. Insert the two screws on each side, through the back edge of the backsplash and into the cooktop. Tighten completely.

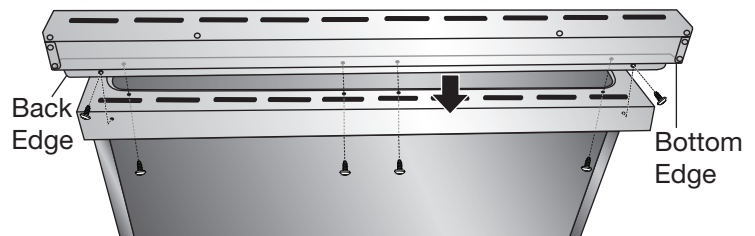

Install Anti-Tip Bracket

⚠ WARNING



Tip Over Hazard

A child or adult can tip the range and be killed.

Connect anti-tip bracket to rear range foot.

Reconnect the anti-tip bracket, if the range is moved.

Failure to follow these instructions can result in death or serious burns to children and adults.

Contact a qualified floor covering installer for the procedure of drilling mounting holes through your type of floor covering.

Assemble the required tools and parts before starting installation. Read and follow the instructions provided with any tools listed here.

Tools needed for installation:

- concrete / ceramic floors: 3/16" (4.6 mm) masonry drill bit
- wood floors: 1/8" (3.2 mm) drill bit
- hand or electric drill
- flat-blade screwdriver
- hammer
- measuring tape
- masking tape

- Anti-tip bracket
- 2 plastic anchors
- 2 screws

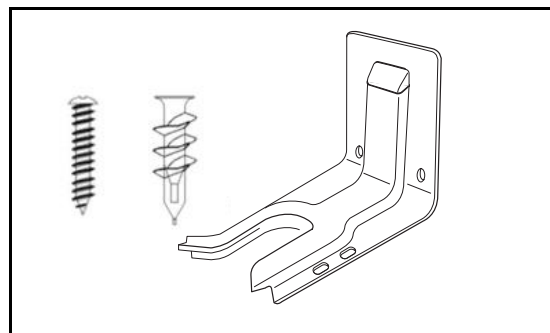

Parts supplied for installation (See Figure 3):

Figure 3

Install the anti-tip bracket to hold the left rear leg of the slide-in range. Follow these steps to secure the range to the floor before moving the range into final operating position.

IMPORTANT: Determine the final location of the range before attempting to install the bracket.

Contact a qualified floor covering installer for the procedure of drilling mounting holes through your type of floor covering.

1. Before moving range, slide range onto shipping base cardboard or hardboard.
2. Place the bracket on the floor with the back edge against the rear wall. If the range does not reach the rear wall, align the back edge of the bracket with the rear panel of the range in its final location. (See Figure 4)

⚠ If bracket does not touch the rear wall, you **MUST** screw bracket to **FLOOR** as described in Step 5.

3. Position the side of the bracket against either the left or right cabinet. If there is no adjacent cabinet, align the edge of the bracket with the side panel of the range in its final location. If the countertop overhangs the cabinet, offset the bracket from the cabinet by the amount of overhang.
4. Mark the location for the pair of holes to be used (see Figure 4).
NOTE: For **FLOOR** installation use either Loc A or B. For **REAR WALL** installation use Loc C.
5. The bracket must be screwed to either the **FLOOR** or **REAR WALL**.

FLOOR Installation:

WOOD FLOOR: Use the screws provided to secure the bracket using the pair of marked holes (either Loc A or B).

CONCRETE FLOOR: Using a concrete bit, drill a 5/32" pilot hole 2" deep into the concrete at the center of each of the marked holes (either Loc A or B). Use the screws provided to secure the bracket into the floor.

REAR WALL Installation:

Use the 2 screws provided to secure the bracket using the pair of marked holes at Loc C. The screws **MUST** enter into a wood sill plate. If the wall contains any metal studs or similar materials, then the floor must be used.

6. After installing the bracket, slide the range into its final location. The rear leveling leg must be fully inserted into the ANTI-TIP bracket as shown in Step 2. To check if the bracket is installed and engaged properly, look underneath the range to see that the rear leveling leg is engaged in the bracket. On some models, the storage drawer or kick panel can be removed for easier inspection. If visual inspection is not possible, slide the range forward, confirm the anti-tip bracket is securely attached to the floor or wall, and slide the range back so the leveling leg is under the anti-tip bracket. If the range is pulled from the wall for any reason, always repeat this procedure to verify the range is properly secured by the anti-tip bracket.)

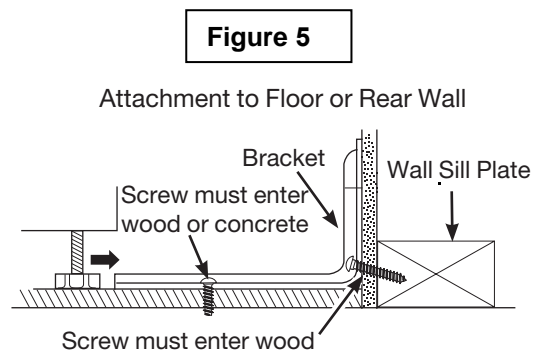
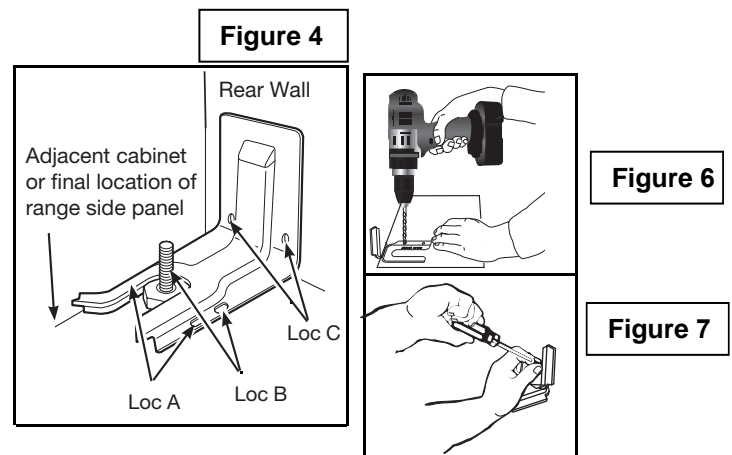

KoolMore Installation Instructions

Electrical Connection

⚠ WARNING



Electrical Shock Hazard

Do not use an adapter.

Do not use an extension cord.

Failure to follow these instructions can result in death, fire, or electrical shock.

Electrical connection must be performed by a qualified service technician in accordance with the kit instructions and all local codes and requirements.

- ⚠ This appliance is not supplied with a plug and needs to be connected directly to the electrical mains.
- ⚠ If you wish to install this appliance with a plug, it must be installed by a qualified service technician. The plug must be a 4-prong, 3-phase power plug that is designed specifically for ranges and ovens.

Electrical Requirements: 220-240V/50-60Hz. With recommendation to connect to a 50 Amp power supply.

ELECTRICAL SPECIFICATIONS	
SYSTEM	WATTAGE
Oven Light	3 x 25 W
Upper Heating Element	2395 W
Bottom Heating Element	1960 W
Grill Heating Element	3158 W
Convection Heating Element	2 x 1250 W
Ventilator Motor	2 x 20 W
Cooling Fan	22.5 W

Installation Instructions

BEFORE MAKING THE ELECTRICAL CONNECTION, MAKE SURE THAT:

⚠ WARNING

- ⚠ The safety circuit-breaker and the electrical system are able to with stand the load of the appliance. See rating label on back of range.
- ⚠ Rating plate is located on back of range should you need to verify any of the electrical requirements.
- ⚠ The power supply system has a ground connection in good working order in accordance with the regulations in force.
- ⚠ The electrical socket is easily accessible with the appliance installed. In all cases, the power supply lead must be positioned so that it does not reach a temperature of 50°C above the room temperature at any point.
- ⚠ The manufacturer is not liable for any direct or indirect damage caused by faulty installation or connection. It is therefore necessary that all installation and connection operations are carried out by qualified personnel complying with the local and general regulations in force.

CONNECTION OF THE RANGE WIRES TO THE MAINS

- 1) This appliance is equipped with the following wires:
 - One black wire (L1 - Live) and one red wire (L2 - Live)
 - One yellow /green (Ground)
- 2) Follow the diagram below to know how to connect the freestanding range wires to the electrical main wires of the home. (See Figure 8)
- 3) The black and red wires can be connected to the electrical main wires of the home in one of the following three configurations:

KoolMore Installation Instructions

- Configuration 1: L1 to L1 and L2 to L2
- Configuration 2: L1 to L1 and L2 to L3
- Configuration 3: L1 to L2 and L2 to L3

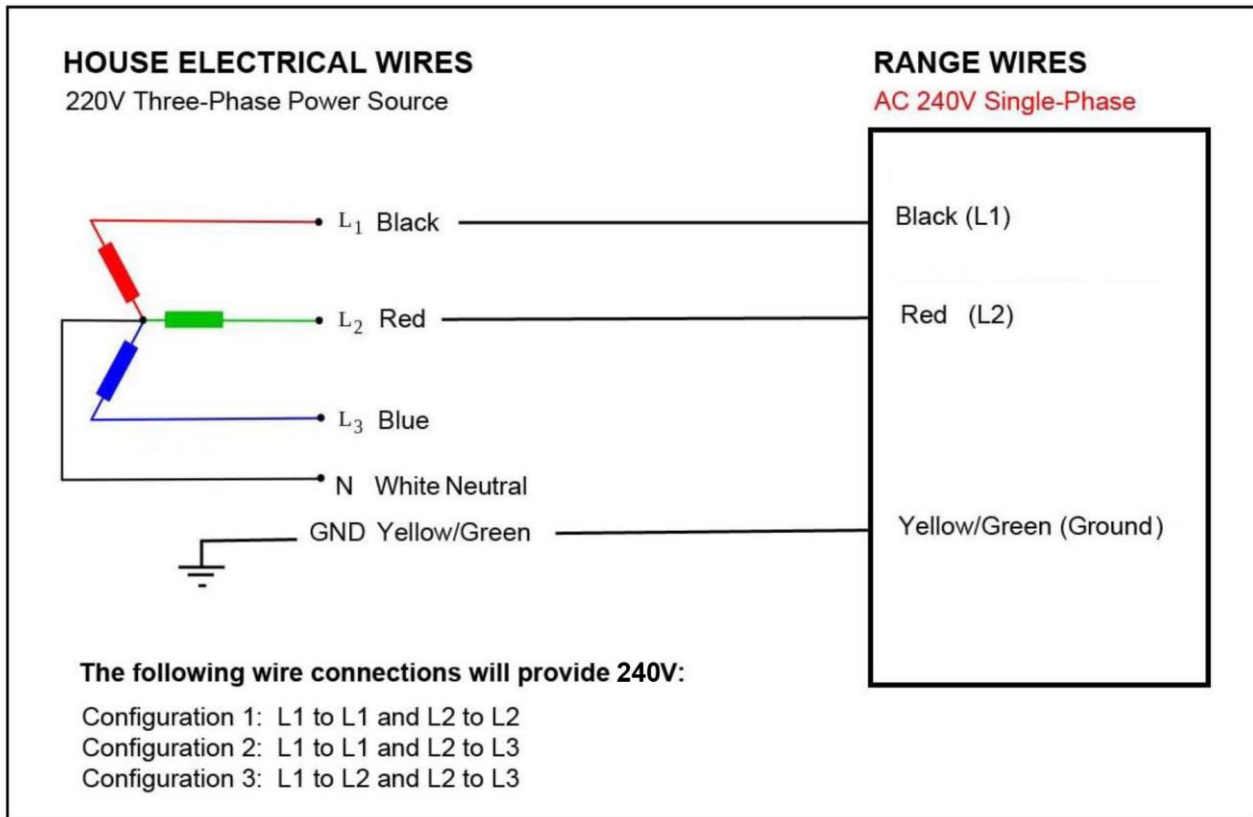

Figure 8

- 4) Never use reductions, shunts, or adaptors which can cause overheating or burning.
- 5) After carrying out the connection to the mains, check that the supplying cable does not come into contact with parts subject to heating.

Surface Cooking

Location of the Burners

- A. Single cooking zone - 1200W
- B. Single cooking zone - 2500W
- C. Single cooking zone - 1800W
- D. Power & Residual Heat Warning Lights

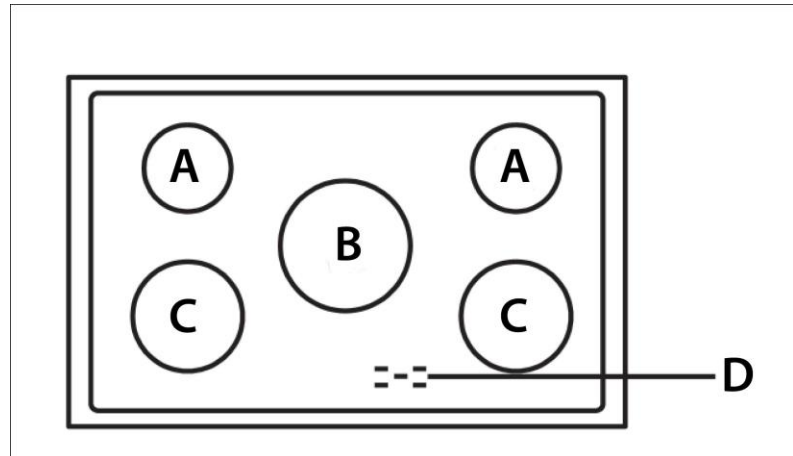

Figure 9

Description of Symbols

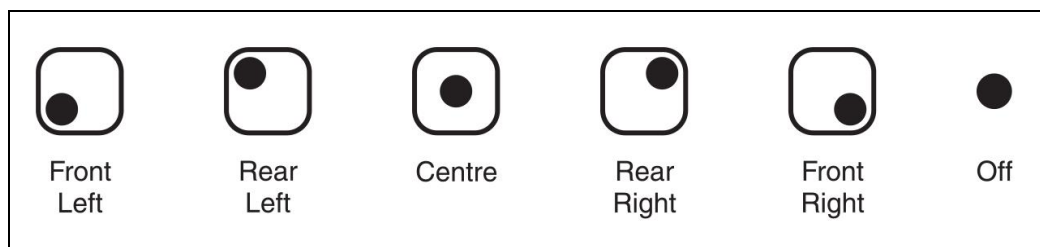

Figure 10

BEFORE FIRST USE:

1. Before cooking for the first time the ceramic glass has to be cleaned. Remove any labels and protective sheeting.
2. Place a saucepan of water on each of the front burners and switch them on the high for at least 30 minutes.
3. After 30 minutes switch the front burners off, place a saucepan of water on each of the rear and the center burners. Switch them on high for at least 30 minutes.
4. This procedure is necessary in order to evaporate any protective oils and humidity that may have collected during the manufacturing process and it will enable the electronic control circuits to operate properly.

Setting Surface Controls

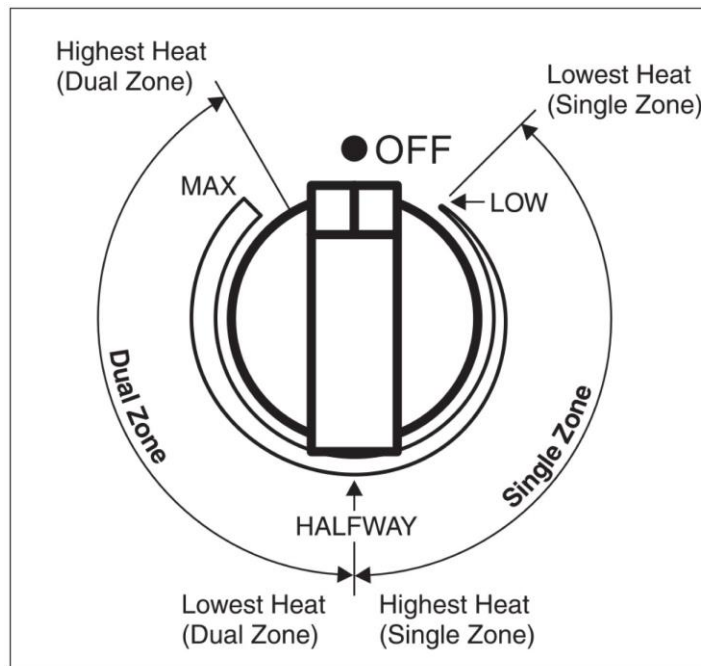

Figure 11

1. Turn the control knob to the desired position (low to high). (See Figure 11)
2. Adjustment is continuous so the cooking zone will operate at any intermediate setting between low and high.
3. Once the cooking zone is hot, the LED corresponding to the zone illuminates.
4. To switch off the cooking zone by turn the knob, in either direction to the ● “OFF” position.
5. The residual heat warning light remains illuminated when the temperature of the ceramic glass surface is hot and will switch off once the surface temperature has cooled.

Surface Cooking Utensils

⚠ *Do not place plastic items such as salt and pepper shakers, spoon holders or plastic wrappings on top of the appliance when it is in use.* These items could melt or ignite. Potholders, towels or wood spoons could catch fire if placed too close to a heat.

⚠ Note: Always use a utensil for its intended purpose. Follow manufacturer's instructions. Some utensils were not made to be used in the oven or on the cooking surface.

- For best results and energy savings, only use pans suitable for electric cooking.
- The bottom of the pan must be very thick and perfectly flat.
- Before placing on the burner, make sure that the pan and burner, are perfectly clean and dry.
- To avoid scratching of the ceramic glass surface, never use cast-iron pans or pans with a rough bottom.

POT SIZES:

- To avoid wasting energy, make sure that the diameter of the pan bottom is 20mm bigger than the circle marked on the hotplate.
- The pot sizes stated in the table below are suitable for your ceramic surface. Solids pots and pans with flat bottoms are recommended for efficient cooking. (See Figure 9)

BURNER ZONE	ZONE DIAMETER	MINIMUM DIAMETER OF PAN
Cooking Zone A	140 mm (5 1/2 inches)	165 mm (6 1/2 inches)
Cooking Zone B	225 mm (8 7/8 inches)	250 mm (9 13/16 inches)
Cooking Zone C	175 mm (7 inches)	200 mm (7 7/8 inches)

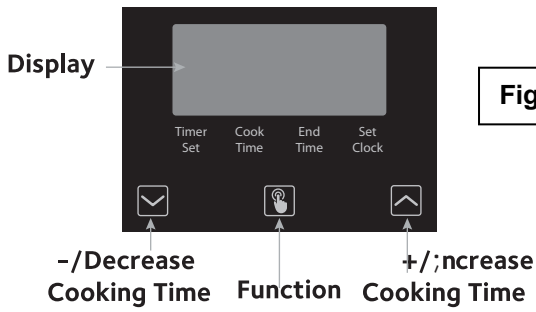

Figure 12

Setting the Clock

- 1) When first connected to AC power or after a power outage, the display will blink "12:00" and the Clock indicator will blink. You can enter the Time Setting mode manually by pressing and releasing the Function button until the Clock indicator blinks.
- 2) To set the correct time, press the ▲ or ▼ button to advance forward or backward until the correct time is displayed. When finished, press the Function button, or wait five seconds; the time will be then set.



IMPORTANT: Clock must be set in order for the oven functions to work.

Setting the Timer

- 1) Enter the Time Setting mode by pressing the Function button once; the Timer indicator will light.
- 2) Set the desired timer time using the ▲ or ▼ button to advance forward or backward until the desired time is displayed. The timer will count down and beep when it is finished.



WARNING:

- Use caution with the timed cooking. Use only when cooking cured or frozen meats or most fruits and vegetables. Timer function should be used with caution when cooking foods that can easily spoil, such as milk, eggs, fish, meat or poultry. Eating spoiled food can result in sickness from food poisoning.

Oven Cooking

Oven Timed Cooking - Delayed Start Timing

To start cooking time, set the TIMER to desired amount of time BEFORE setting oven function and temperature.

- 1) Press and release the Function button until the Start indicator blinks.
- 2) Set the amount of time desired by pressing the ▲ or ▼ button until the chosen timing is displayed, for a maximum of 10 hours.
- 3) Set the Temperature and Cooking knobs as desired (see pages 26 to 28 for descriptions and operation) and place the food in the oven.

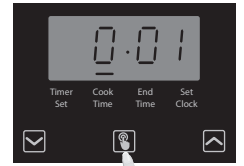

Note: Oven will not operate until the programmed Start Time is reached. To operate oven before the Start Time, the Delay Start function must be cancelled.

Programing the End Timing

To end cooking time, set the TIMER to desired shut off time:

- 1) Press the Function button again until the End indicator blinks.
- 2) Set the end timing by pressing the ▲ or ▼ button until the desired amount of time is displayed, for a maximum of 11 hours 59 minutes. Press the Function button again to set.
- 3) When the end of timed cooking is reached, the unit will beep. Rotate the Temperature and Cooking knobs to their OFF positions, and then press the Function button to turn off the beeping.



Setting Oven Controls

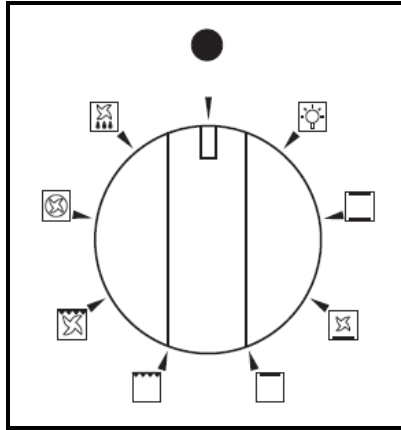

Figure 13

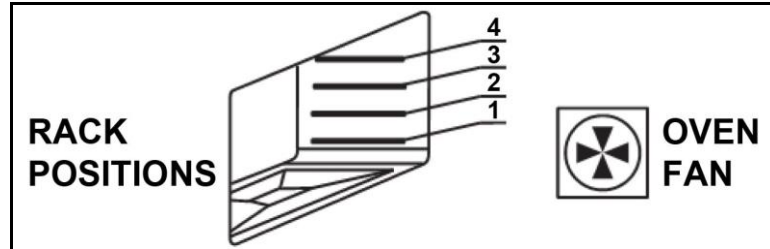

Figure 14

- Selection of cooking temperature is carried out by turning the knob clockwise to the required temperature.
- The warning light will illuminate during the heating process.
- Once the oven reaches desired temperature, the light will go out.
- Regular flashing means that the oven temperature is being maintained at the programmed level.



OVEN LIGHT INDICATOR

The lamp of the oven is on. During oven operation the lamp will always remain on.



TRADITIONAL COOKING (Upper and Lower element)

THERMOSTAT SELECTOR SWITCH FROM 60° C (140° F) TO MAX

The heat is provided from the top and bottom elements. The oven must be preheated before the food is placed inside. Static cooking provides optimum results with: cakes, pizzas, bread and for gentle slow cooking of casseroles. Characteristics of static cooking: heat provided from above and below, cooking is possible only on middle shelf and should be centrally located in the oven.

Installation Instructions



DELICATE COOKING (Lower element and Fan)

THERMOSTAT SELECTOR SWITCH FROM 60° C (140° F) TO MAX

Ideal for pastries and cakes with wet covering and little sugar and damp desserts in moulds. Excellent results can also be achieved in completing cooking at the bottom and with dishes requiring heat in the lower area in particular. The plate is best inserted at bottom level.



UPPER ELEMENT COOKING

THERMOSTAT SELECTOR SWITCH FROM 60° C (140° F) TO MAX

This is best used to brown select dishes at the end of cooking.



GRILL COOKING (Grill element)

THERMOSTAT SELECTOR SWITCH FROM 60° C (140° F) TO MAX

The use of the grill element is best reserved for: melting cheese, toasting, and browning. The cooking time should be no longer than 5 minutes. To operate, please select Full Grill Function along with the temperature.



FAN ASSISTED GRILL COOKING (Grill element and Fan)

THERMOSTAT SELECTOR SWITCH FROM 60° C (140° F) TO 200° C (392° F)

Best used for grilling meats, vegetables, and poultry. Preheat the oven, place food on a grilling rack or backing tray and place in the middle of the oven. Other racks can be used simultaneously using this method.



CONVECTION COOKING (Cooking element & Fan)

THERMOSTAT SELECTOR SWITCH FROM 60° C (140° F) TO MAX

This method allows even-heat multi-rack cooking for various types of foods with the appropriate cooking times for each dish. The oven must be preheated before the foods are placed inside. Use the 'Fan Forced' function to operate.



DEFROST (Bottom fan)

All types of food can be defrosted by circulating air at room temperature: cakes, cream, fruit, etc. For foods such as: meat, fish, and bread you will want to set the fan temperature to 175-200° C (347-392° F).

KoolMore Installation Instructions

Cooking Instructions

Setting:	Food:	Rack Level (See Figure 33)	Temperature (Fahrenheit):	Time (mins):
Traditional Cooking (add time for preheat)	Lasagna	2-3	410-450	30
	Oven-Baked Pasta	2-3	410-450	40
	Roast Veal	2	350-400	30-40/lb
	Beef	2	410-460	30-40/lb
	Pork	2	340-400	30-40/lb
	Chicken	2	340-400	45-60
	Duck	2	340-400	45-60
	Goose/Turkey	1	280-340	45-60
	Lamb	2	340-400	15/lb
	Fish	1-2	340-400	Depends on dimension
	Pizza	1-2	410-450	40-45
	Short Pastry	1-2	340-400	15-20
	Fruit Cake	1-2	340-400	20-30
	Browning	3-4	140	5
	Convection Cooking (add time for preheat)	Lasagna	2-3	375-410
Oven-Baked Pasta		2	375-410	25-30
Roast Veal		2	300-350	65-90
Beef		2	350-375	65-90
Pork		2	300-325	70-100
Chicken		2	350	70-90
Duck		2	325-350	100-160
Goose/Turkey		2	300-325	160-240
Lamb		2	300-350	100-130
Fish		2-3	300-350	Depends on dimension
Pizza		2-3	410-475	30-50
Sponge Cake		2-3	375-425	25-35
Fruit Cake		2-3	350-375	40-50
Bread		1-2	425-475	7
Setting:		Food:	Rack Level (See Figure 33)	1 st Side Cook Time (mins):
Grill Cooking	Pork Chops	4	7-9	5-7
	Fillet (Pork)	3	9-11	5-9
	Fillet (Beef)	3	9-11	9-11
	Liver	4	2-3	2-3
	Veal	4	7-9	5-7
	Chicken	3	9-14	9-11
	Sausages	4	7-9	5-6
	Meatballs	4	7-9	5-6
	Fish Fillet	4	5-6	3-4
	Toast	4	2-4	2-3

Care and Cleaning

⚠ WARNING



ELECTRICAL SHOCK HAZARD

⚠ DANGER

BURN HAZARD

To avoid possible burns use care when cleaning the appliance.

DO NOT attempt to clean the appliance whenever the oven or burner heads are still hot.

To avoid possible burns **DO NOT** attempt any of the following cleaning instructions before turning **OFF ALL** of the surface burners and allowing them to cool.

IMPORTANT: Always follow label instructions on cleaning products.

• **Control Knobs**

- For general cleaning, use hot, soapy water and a cloth.
- For more difficult soils and built-up grease, apply a liquid detergent directly onto the soil. Rinse with a damp cloth and dry.
- **DO NOT** use steel wool or acidic cleaners on the knobs as they can scratch.

• **Stainless Steel**

- Clean stainless steel with hot, soapy water and a dishcloth. Rinse with clean water and a cloth.
- Do not use cleaners with high concentrations of chlorides or chlorines. Do not use harsh scrubbing cleaners. Only use kitchen cleaners that are especially made for cleaning stainless steel.

• **Inside Oven**

- This appliance does **NOT** have a self-cleaning feature.
- **DO NOT** attempt to clean the appliance whenever the oven is still hot.
- Use an appropriate cleaning product designed specifically to clean the inside of ovens.
- **IMPORTANT:** Always follow label instructions on cleaning products.

KoolMore Installation Instructions

• Storage Drawer

- Make sure drawer is cool and empty before cleaning.
- Use a mild detergent.

• Oven Door Exterior

- Use a glass cleaner and a soft cloth or sponge.
- Apply glass cleaner to soft cloth or sponge, not directly on panel.

• Removing and Cleaning the Oven Door

For normal range use, it is not suggested to remove the oven door. However, if removal is necessary, make sure the oven is off and cool. The oven door is heavy. Follow these instructions.

- Open the door fully.
 - Lift up and push the small levers located on the two hinges all the way back.
 - While holding the door on each side, shut the door until it touches the levers.
 - Then continue closing the door until it is about 4 inches (10cm) from being fully closed.
 - Pull the door towards you, pulling it out of its seat. Door will gently come away from the oven. (See Figure 15)
- To replace the door, perform the reverse of the above procedure.
- Please note: If door does not come away from oven easily, do not force it.

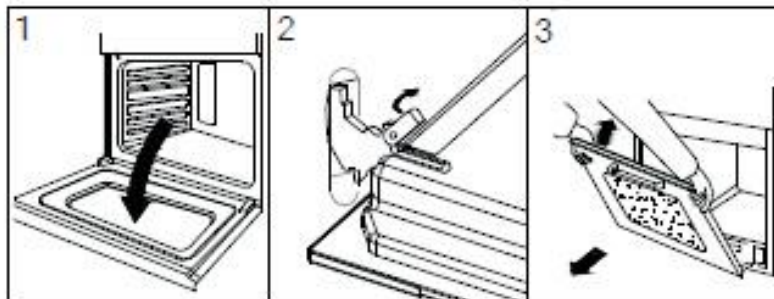

Figure 15

KoolMore Installation Instructions

• Changing the Interior Oven Light Bulb

⚠ WARNING



ELECTRICAL SHOCK HAZARD

- Ensure that the appliance is switched off before replacing the lamp to avoid possible electric shock.
- Remove the glass cover by turning counter clockwise. (See Figure 16)
- Replace bulb with a high temperature bulb able to withstand 600 degrees and that meets the following criteria:
 - 240V
 - 25W
 - Type: E-14

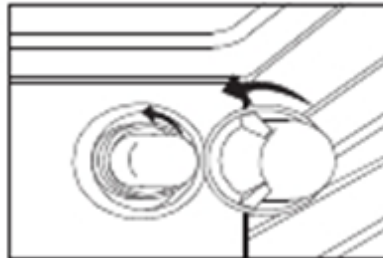

Figure 16

Solutions to Common Problems

IMPORTANT

Before calling for service, review this list. It may save you both time and expense. This list includes common experiences that are not the result of defective workmanship or material in your appliance.

⚠ WARNING

Electrical Shock Hazard

Plug into a grounded 3 prong outlet.

Do not remove ground prong.

Do not use an adapter.

Do not use an extension cord.

Failure to follow these instructions can result in death, fire, or electrical shock.

NOTHING WILL OPERATE

■ Is the electrical supply disconnected?

Verify that electrical wires are connected to the mains properly. See “Electrical Connection” section. If the problem continues, contact a qualified technician.

■ Household fuse blown or circuit breaker tripped?

Replace the fuse or reset the circuit breaker. If the problem continues, contact a qualified technician.

SURFACE BURNERS WILL NOT OPERATE

■ Is the control knob set correctly?

Push in knob before turning to a setting.

EXCESS HEAT AROUND COOKWARE ON COOKING SURFACE

■ Is the cookware the proper size?

Use cookware about the same size as the surface cooking area, element or surface burner. Cookware should extend 20mm outside the cooking area.

COOKTOP COOKING RESULTS NOT WHAT EXPECTED

■ Is the proper cookware being used?

See “Surface Cooking Utensils” section.

■ Is the control knob set to the proper heat level?

See “Setting Surface Controls” section.

■ Is the range level?

Level the range. See the “Unpack Range / Install Leveling Feet and Back Panel” section.

OVEN WILL NOT OPERATE

■ Are the oven controls set correctly?

See “Setting Oven Controls” section.

COOLING FAN RUNS DURING BAKING AND BROILING

■ It is normal for the fan to automatically run while the oven is in use and for some time after to cool.

OVEN TEMPERATURE TOO HIGH OR TOO LOW

■ Was the oven preheated?

See “Cooking Instructions” section.

■ Are the racks positioned properly?

See “Cooking Instructions” section.

■ Is there proper air circulation around bakeware?

See “Cooking Instructions” section.

■ Is the batter evenly distributed in the pan?

Check that batter is level in the pan.

■ Is the proper length of time being used?

Adjust cooking time.

■ Has the oven door been opened while cooking?

Oven peeking releases oven heat and can result in longer cooking times.

■ Are baked items too brown on the bottom?

Move rack to higher position in the oven.

■ Are pie crust edges browning early?

Use aluminum foil to cover the edge of the crust and/or reduce baking temperature.



Warranty

Limited Service Warranty Valid only in the United States

1 Year Parts and Labor Warranty

Unless otherwise stated, Koolmore Supply Inc. warrants to the original purchaser of new Koolmore electric range oven, that such equipment will be free from defects in material and workmanship for a period of 1 year from the date of delivery. Valid only in the Continental United States.

Coverage Limitations

The 1 year parts and labor warranty do not cover:

Failure to install and/or use the equipment within proper operating conditions specified by Koolmore. This includes but is not limited to residential, outdoor, or mobile applications.

Any adjustments necessitated by improper operating conditions.

Damage caused by improper electrical connection, power failure, or generators.

Failure to properly maintain the unit including all preventive maintenance and cleaning.

Equipment sold or used outside of United States, equipment purchased second-hand, equipment sold by an unauthorized reseller, and equipment expressly sold without warranty coverage.

Equipment without a valid serial number and proof of purchase, or other way to verify warranty coverage.

Equipment that has not been used appropriately or was subject to misuse, neglect, abuse, accident, alteration, negligence, damage during transit, delivery or installation, fire, flood, or an act of God.

Equipment that has been altered, modified, or repaired by anyone other than an authorized service agency outside of preventative maintenance and cleaning.

Parts deemed by Koolmore to be normal wear and tear parts, including hoses and select plastic or rubber components.

For Warranty Inquiries or Service:

This warranty is only valid on equipment purchased from an authorized dealer.

Locate the model number.

Next, call 1-718-576-6342. You must have the model number when contacting service technicians.

Failure to contact Koolmore prior to obtaining equipment service may void your warrant

