



Scan to see the online manual.



OWNER'S MANUAL

# CERAMIC-GLASS RADIANT COOKTOP

---

Read this owner's manual thoroughly before operating the appliance and keep it handy for reference at all times.

**ENGLISH**

LSCE305ST LSCE365ST



MFL54169102  
Rev.18\_082523

[www.lg.com](http://www.lg.com)

Copyright © 2010-2023 LG Electronics Inc. All Rights Reserved.

## **TABLE OF CONTENTS**

### **3 IMPORTANT SAFETY INSTRUCTIONS**

---

- 3 READ ALL INSTRUCTIONS BEFORE USE
- 3 WARNING STATEMENTS
- 6 CAUTION STATEMENTS

### **8 PRODUCT OVERVIEW**

---

- 8 Product Features

### **9 INSTALLATION**

---

- 9 Before Installing
- 13 Installing the Cooktop

### **18 OPERATION**

---

- 18 Cookware
- 20 Control Panel

### **25 MAINTENANCE**

---

- 25 Care and Cleaning

### **27 TROUBLESHOOTING**

---

- 27 Before Calling for Service

### **29 LIMITED WARRANTY**

---

- 29 USA

# IMPORTANT SAFETY INSTRUCTIONS

## READ ALL INSTRUCTIONS BEFORE USE

### Safety Messages

**Your safety and the safety of others are very important.**

We have provided many important safety messages in this manual and on your appliance. Always read and follow all safety messages.



This is the safety alert symbol.

This symbol alerts you to potential hazards that can kill or injure you and others. All safety messages will follow the safety alert symbol and either the word WARNING or CAUTION.

These words mean:



#### **WARNING**

You may be killed or seriously injured if you do not follow instructions.



#### **CAUTION**

You may be injured or cause damage to the product if you do not follow instructions.

All safety messages will tell you what the potential hazard is, tell you how to reduce the chance of injury, and tell you what may happen if the instructions are not followed.

## WARNING STATEMENTS



### **WARNING**

- To reduce the risk of explosion, fire, death, electric shock, scalding or injury to persons when using this product, follow basic precautions, including the following:

### Installation

- Be sure your appliance is properly installed and grounded by a qualified technician in accordance with the National Electrical Code ANSI/NFPA No. 70, latest edition in the United States, and all local code requirements. Install only per installation instructions.
- The safety aspects of this appliance comply with accepted technical standards.
- Never modify or alter the construction of an appliance such as removal of panels, wire covers or any other permanent part of the product.
- Remove all tape and packaging wrap before using the appliance. Destroy the carton and plastic bags after unpacking the appliance. Never allow children to play with packaging material.
- The installation and connection of the new appliance must only be carried out by qualified personnel.

### Operation

- Know how to disconnect the electrical power to the appliance at the circuit breaker or fuse box in case of an emergency. Mark the breaker or fuse for ease of identification and swift action if necessary.
- Never use your appliance for warming or heating a room.
- DO NOT touch cooking zones or areas near these surfaces. Cooking zones may be hot from residual heat even though they are dark in color. Areas near the cooking zones may become hot enough to cause burns. During and after use, do not touch, or let clothing or other flammable materials touch these areas until they have had sufficient time to cool.

## 4 IMPORTANT SAFETY INSTRUCTIONS

---

- Never wear loose fitting or hanging garments while using this appliance.
- Always turn off all controls when cooking is completed.
- Do not use water or flour on grease fires. Smother the fire with a pan lid, or use baking soda or a dry chemical or foam-type extinguisher.
- Use only dry pot holders. Moist or damp pot holders on hot surfaces may result in burns from steam. Do not let pot holders touch hot surface units. Do not use a towel or other bulky cloth instead of a pot holder.
- Do not heat unopened food containers. A buildup of pressure may cause the container to burst and result in injury.
- Flammable materials should not be stored near or on the cooking surface. This includes paper, plastic and cloth items, such as cookbooks, plasticware and towels, as well as flammable liquids. Do not store explosives, such as aerosol cans, on or near the appliance. Flammable materials may explode and result in fire or property damage.
- Do not store or use gasoline or other flammable vapors and liquids in the vicinity of this or any other appliance.
- Never place combustible items on the cooktop.
- Never keep any combustible items or aerosol cans in a drawer located under the cooktop.
- When heating fat or grease, watch it closely. Fat or grease may catch fire if allowed to become too hot.
- Overheated fats and oils catch fire quickly. You should supervise cooking when preparing foods in fat or oil.
- Use a deep fat thermometer, if possible, to prevent overheating fat beyond the smoking point.
- If the surface is cracked, switch off the appliance to avoid the possibility of electric shock. Do not reuse your cooktop until the glass surface has been replaced.
- When using the cooktop, never use aluminum foil, products wrapped in aluminum foil, or deep-frozen food in aluminum cookware.
- This appliance is not intended for use by young children or infirm persons unless they have been adequately supervised by a responsible person to ensure that they can use the appliance safely.
- Young children should be supervised to ensure that they do not play with the appliance.
- Accessible parts may become hot during use. Young children should be kept away.
- Items of interest to children should not be stored in cabinets above a cooktop or on the backsplash of a cooktop – children climbing on the cooktop to reach items could be seriously injured.
- Children should not be left alone or unattended in the area where an appliance is in use. They should never be allowed to sit or stand on any part of the appliance.
- Take care when plugging in electric appliances near the cooktop. Cords must not come into contact with the hot surface. Doing so could cause damage to the cooktop and cable insulation.
- After use, switch off the cooktop element by its control and do not rely on the pan detector.
- Avoid placing metal objects such as knives, forks, spoons and lids on the cooking surface areas. Metal objects can become hot and cause burns.
- Do not place any object on or near the display area in order to prevent accidental activation of the cooktop controls.
- Cookware handles should be turned inward and not extend over adjacent surface units. To reduce the risk of burns, ignition of flammable materials, and spillage due to unintentional contact with the cookware, the handles of cookware should be positioned so that they are turned inward, and do not extend over adjacent surface units.
- Never leave prepared food on the cooking zones. Boilovers cause smoking and greasy spillovers that may ignite, or a pan that has boiled dry may melt or become damaged.
- Do not use aluminum foil to line any part of the cooktop. Only use aluminum foil as recommended after the cooking process, if used as a cover to be placed over the food. Any other use of aluminum foil may result in the risk of electric shock, fire or short circuit.

- Do not clean or operate a broken cooktop. If the cooktop breaks, cleaning solutions and spillovers may penetrate the broken cooktop and create a risk of electric shock. Contact a qualified technician immediately.
- Never leave surface units unattended at high heat settings. Boilover causes smoking and greasy spillovers that may ignite.
- Always turn off all controls when cooking is completed.
- Keep pets away from the product to avoid risk of fire or burns. Do not allow pets to climb on the product even when it is not in operation.
- Liquids such as water, coffee or tea are able to be overheated beyond the boiling point without appearing to be boiling, due to surface tension of the liquid. Visible bubbling or boiling is not always present when the container is removed from the cooktop. This could result in very hot liquids suddenly boiling over when the container is disturbed or a spoon or other utensil is inserted into the liquid. To reduce the risk of injury to persons:
  - Do not overheat the liquid.
  - Stir the liquid both before and halfway through heating it.
  - Do not use straight-sided containers with narrow necks.
  - After heating, allow the container to stand on the cooktop for a short time before moving the container.
  - Use extreme care when inserting a spoon or other utensil into the container after heating.
- Do not use the cooktop as a work surface or storage space.
- Do not operate the cooking zones with empty pots or pans.
- Do not turn on the cooking zones with no pots or pans on the element.

## Maintenance

- Do not repair or replace any part of the appliance. All servicing should be done only by a qualified technician to avoid the risk of personal injury and damage to the appliance.
- Take care to avoid steam burns if using a wet sponge or cloth to wipe spills on a hot cooking area.
- Wait for the cooktop to cool before using cooktop cleaners. Some cleaners can produce NOXIOUS FUMES if applied to a hot surface.
- If the supply cord is damaged, it must be replaced by the manufacturer, its service agent or similarly qualified persons in order to avoid a hazard.
- If your appliance malfunctions or fractures, switch off all cooking zones, and contact an LG Customer Information Center for service.
- Always keep the control panel clean and dry. Do not let liquids or grease remain on the cooktop display area. Spilled or burnt-on foods can activate or deactivate the appliance. Clean the display area thoroughly to resume normal operation of the appliance.
- Clean the appliance regularly to keep all parts free of grease that could catch fire. Exhaust fan ventilation hoods and grease filters should be kept clean. Do not allow grease to accumulate on the hood or filters. Greasy deposits in the fan could catch fire. Refer to the hood manufacturer's instructions for cleaning.

## CAUTION STATEMENTS

### CAUTION

- To reduce the risk of minor or moderate injury to persons, malfunction, or damage to the product or property when using this product, follow basic precautions, including the following:
- 

### Operation

- This appliance may only be used for normal cooking and frying in the home. It is not designed for commercial or industrial purposes.
- Use proper pan sizes. This appliance is equipped with one or more surface units of different sizes.
- Select cookware having flat bottoms large enough to cover the cooking zones.
- Only certain types of glass, glass/ceramic, ceramic, earthenware, or other glazed cookware are suitable for rangetop service without breaking due to the sudden change in temperature. Check the manufacturer's recommendations for cooktop use.
- Do not place hot cookware on cold cooktop glass. This could cause the glass to break.
- Do not slide pans across the cooktop surface. They may scratch the cooktop surface.
- Do not let pans boil dry. This may cause permanent damage in the form of breakage, fusion, or marking that can affect the ceramic-glass cooktop. (This type of damage is not covered by your warranty.)
- Cook meat and poultry thoroughly, meat to at least an INTERNAL temperature of 160 °F and poultry to at least an INTERNAL temperature of 180 °F. Cooking to these temperatures usually protects against food-borne illnesses.
- Prior to using the cooktop for the first time, apply the recommended cooktop cleaning cream to the ceramic surface. Buff with a non-abrasive cloth or pad. This will make cleaning easier when the cooktop gets soiled from cooking. The special cooktop cleaning cream leaves a protective finish on the glass to help prevent scratches and abrasions.
- Please be careful of the cooktop edges when moving pots and pans.
- Ceramic glass is very tough, and impervious to sharp temperature changes, but is not unbreakable. It can be damaged if hard or sharp objects fall on it.
- Be very cautious if using pots made of cast iron, or other pots with rough edges or burrs. Moving these can cause scratches on the glass.
- Do not slide metal or glass across the cooktop surface.
- Do not use cookware with any dirt buildup on the bottom.
- Do not use cookware with rough or uneven bottoms. This cookware can mark and scratch the cooktop surface.
- Do not use the glass cooktop surface as a cutting board.
- The appliance is not intended to be operated by means of an external timer or separate remote-control system.

### Maintenance

- Always switch off the appliance before cleaning.
- For safety reasons, do not clean the appliance with a steam jet or high-pressure cleaner.
- Clean the cooktop in accordance with the maintenance and cleaning instructions in this manual.
- Do not use harsh abrasive cleaners or rough metal scrapers to clean the cooktop glass since they can scratch the surface, which may result in shattering of the glass.
- Clean the cooktop cautiously. Do not use sponges or cloth to wipe spills on a hot cooking area. Use a proper metal scraper.

- If sugar or a mixture containing sugar falls onto a hot cooking zone and melts, remove it with a metal scraper immediately, while still hot. If left to cool down, it may damage the surface when removed. Use caution and wear an oven mitt to avoid burns.
- Keep meltable objects or materials away from the ceramic glass surface, for example, plastic utensils, aluminum foil, or cooking wraps. If any materials or foodstuffs melt on the ceramic-glass surface, these should be cleaned up immediately.
- Use oven mitts to avoid burns when using a metal scraper on a hot cooking zone.
- Refer to the Maintenance section for proper cleaning and maintenance of the cooktop.

## Disposal of Old Appliances

To protect the environment, it is important that worn-out appliances are disposed of in the correct manner.

- The appliance must not be disposed of with household rubbish.
- You can obtain information about collection dates or public refuse disposal sites from your local government or waste collection service.
- Before disposing of old appliances make them inoperable so they cannot be a source of danger. To do this, have a qualified person disconnect the appliance from the house circuitry.

**SAVE THESE INSTRUCTIONS**

# PRODUCT OVERVIEW

## Product Features

### Parts and Features

Throughout this manual, features and appearance may vary from your model.

#### LSCE305ST

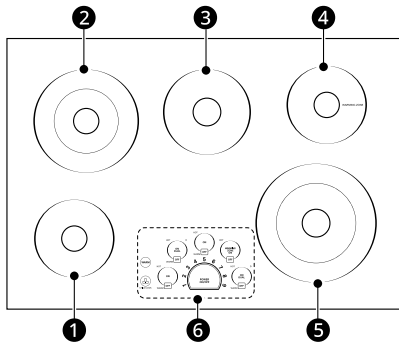

Parts and Features	
❶	Single Cooking Zone 6" (152 mm)
❷	Dual Cooking Zone 8"/5" (203 mm/127 mm)
❸	Single Cooking Zone 7" (178 mm)
❹	Warming Zone 6" (152 mm)
❺	Dual Cooking Zone 9"/6" (229 mm/152 mm)
❻	Control Panel

#### LSCE365ST

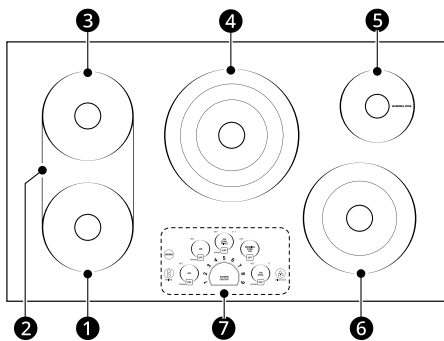

Parts and Features	
❶	Single Cooking Zone 7" (178 mm)
❷	Bridge Cooking Zone

Parts and Features	
❸	Single Cooking Zone 7" (178 mm)
❹	Triple Cooking Zone 12"/9"/6" (305 mm/229 mm/152 mm)
❺	Warming Zone 6" (152 mm)
❻	Dual Cooking Zone 9"/6" (229 mm/152 mm)
❼	Control Panel

### Accessories

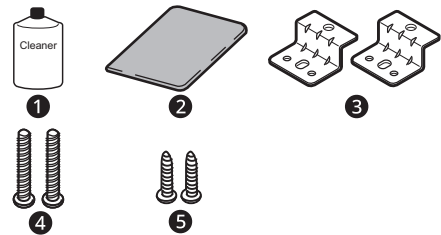

- ❶ Cooktop Cleaner (1 ea)
- ❷ Non-scratch Scouring Pad (1 ea)
- ❸ Retainer Brackets (2 ea)
- ❹ Bolts (2 ea)
- ❺ Type A Screws (2 ea)



# INSTALLATION

## Before Installing

### Before You Begin

Installation and service must be performed by a qualified installer.

Important: Save these instructions for the local electrical inspector's use. Read and save these instructions for future reference.

Read these instructions completely and carefully.

### ⚠ CAUTION

- If storage is located under the cooktop, do not use it to store flammable or heat-sensitive items such as detergents, aerosols, cleaners, water, food, or plastics.

### NOTE

Installer:

- Read all installation instructions before installing the cooktop.
- Remove all packing material before connecting the electrical supply to the cooktop.
- Observe all governing codes and ordinances.
- Only certain cooktop models may be installed over certain built-in electric oven models.
- Be sure to leave these instructions with the consumer.

### NOTE

Consumer:

- Keep this owner's manual and installation instructions for future reference.

### NOTE

- This appliance must be properly grounded.
- Damage caused by failure to follow these instructions is not covered by the cooktop warranty.

## Tools Needed

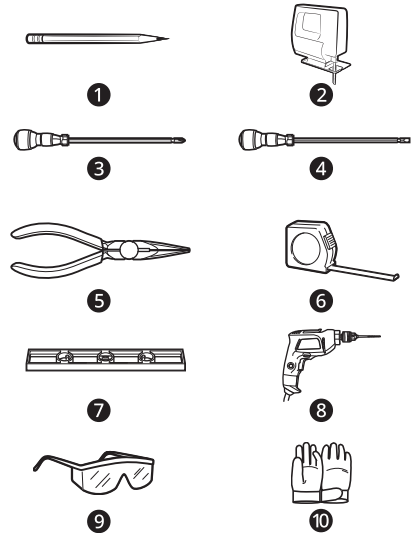

- 1 Pencil
- 2 Saber Saw
- 3 Phillips Screwdriver
- 4 Flat-blade Screwdriver
- 5 Pliers
- 6 Tape measure
- 7 Level
- 8 Drill
- 9 Safety Glasses
- 10 Gloves

## Parts not Provided

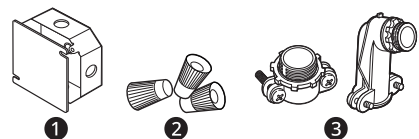

- 1 Junction Box
- 2 Wire Nuts
- 3 Strain Relief (Conduit Connector)

## Unpacking the Cooktop

- 1 Unpack and visually inspect the cooktop for any damage or missing components.
- 2 Be sure the bottle of cleaner and conditioner packed in the literature bag is left where the user can find it easily. It is important that the

ceramic-glass cooktop be pretreated before use. See Care and Cleaning.

### Model and Serial Number Location

The model and serial numbers are located on a plate on the bottom of the cooktop. Please record them in this guide; you will need them for warranty registration.

## Technical Specifications

Models		LSCE305ST		
<b>Description</b>		Radiant Cooktop		
<b>Electrical Specifications</b>	<b>Connection voltage</b>	240/208 VAC 60 Hz., 32.1 A/27.9 A		
	<b>Maximum connected power load</b>	7700 W/5800 W		
<b>Cooktop Dimensions</b>		30 27/32" (783 mm) (W) x 4" (101.6 mm) (H) x 21 23/32" (552 mm) (D)		
<b>Countertop Cutout Dimensions</b>		Standard Installation 29 3/8" (746 mm) (W) x 20 1/4" (515 mm) (D)		
<b>Cooking Zones</b>	<b>Position</b>	<b>Size</b>	<b>Power</b>	
	Front Left	6" (152 mm)	1200 W	
	Front Right	9"/6" (229 mm/152 mm)	3000 W/1400 W	
	Rear Left	8"/5" (203 mm/127 mm)	1900 W/950 W	
	Rear Right	6" (152 mm)	100 W (Warm)	
	Center	7" (178 mm)	1500 W	

Models		LSCE365ST		
<b>Description</b>		Radiant Cooktop		
<b>Electrical Specifications</b>	<b>Connection voltage</b>	240/208 VAC 60 Hz., 43.8 A/38.0 A		
	<b>Maximum connected power load</b>	10500 W/7900 W		
<b>Cooktop Dimensions</b>		36 11/16" (932 mm) (W) x 4" (101.6 mm) (H) x 22 15/32" (571 mm) (D)		
<b>Countertop Cutout Dimensions</b>		Standard Installation 34 9/16" (878 mm) (W) x 20 3/8" (517 mm) (D)		

Models	LSCE365ST		
<b>Cooking Zones</b>	<b>Position</b>	<b>Size</b>	<b>Power</b>
	Front Left	7" (178 mm)	1800 W (Bridge)
	Front Right	9"/6" (229 mm/152 mm)	3000 W/1400 W
	Rear Left	7" (178 mm)	1800 W+800 W (Bridge)
	Rear Right	6" (152 mm)	100 W (Warm)
	Center	12"/9"/6" (305 mm/229 mm/152 mm)	3000 W/2200 W/1100 W

**NOTE**

- The maximum power of each cooking zone depends on the size and material of the cookware used.

## Preparing the Installation Location

### Important Installation Information

- All electric cooktops run off a single phase, three-wire or four-wire cable, 240/208 volt, 60 hertz, AC-only electrical supply with ground.
- Minimum distance between cooktop and overhead cabinetry is 30" (762 mm).
- Make sure the cabinets and wall coverings around the cooktop can withstand the temperatures (up to 93 °C [200 °F]) generated by the cooktop.

### Dimensions and Clearances

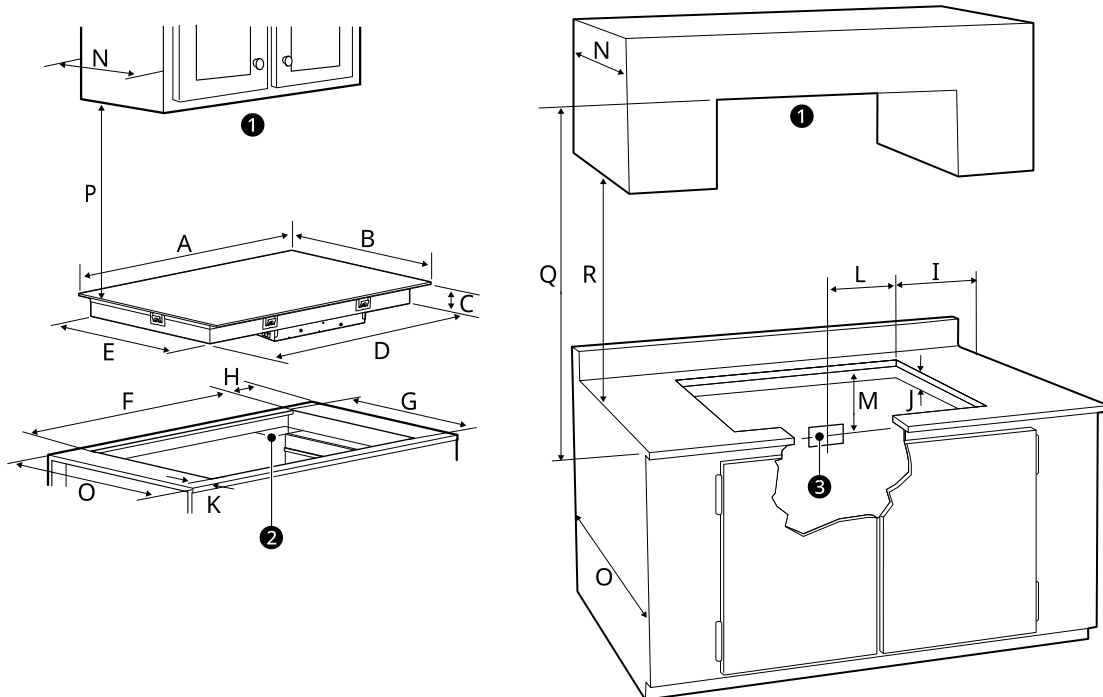

- ❶ Do not obstruct these areas.
- ❷ 4" X 8" (102 mm x 203 mm) opening to route armored cable if panel is present.
- ❸ Approximate location of junction box

-	Dimension/Clearance	LSCE305ST	LSCE365ST
A	Width of upper plate	30 27/32" (783 mm)	36 11/16" (932 mm)
B	Depth of upper plate	21 23/32" (552 mm)	22 15/32" (571 mm)
C	Height of cooktop base	3 3/4" (95 mm)	
D	Width of cooktop base	28 13/16" (732 mm)	33 27/32" (860 mm)
E	Depth of cooktop base	19 5/8" (498 mm)	19 25/32" (502 mm)
F	Width of cutout	29 3/8" (746 mm)	34 9/16" (878 mm)
G	Depth of cutout	20 1/4" (515 mm)	20 3/8" (517 mm)

-	Dimension/Clearance	LSCE305ST	LSCE365ST
H	Distance from side edge of cutout to side of counter	13/16" (20 mm)	
I	Distance from edge of cooktop to nearest combustible wall (either side of unit)	≥3 3/4" (95 mm)	
J	Height below cutout (Empty space is needed underneath the cooktop for installation purposes.)	≥ 5 23/32" (145 mm)	
K	Distance from front of counter to front edge of cutout	2 1/2" (64 mm)	
L	Junction box (approximate location)	10" (254 mm)	
M	Junction box (approximate location)	12" (305 mm)	
N	Depth of overhead cabinets	≤ 13" (330 mm)	
O	Depth of bottom cabinets	24" (610mm)	
P	Clearance from top of cooking surface to bottom of overhead cabinets	≥30" (762 mm)	
Q	Distance between rear edge of cutout and nearest combustible surface.	≥36" (914 mm)	
R	Clearance from countertop to bottom of adjacent cabinets	≥18" (457 mm)	

All dimensions are stated in inches and millimeters (mm).

Allow 2" (50 mm) below the armored cable opening to clear the electric cable and allow space for installation of the junction box on the wall at the back of the cooktop.

**⚠ CAUTION**

- To eliminate the risk of burns or fire by reaching over heated surfaces, cabinet storage space located above the cooktop should be avoided. If cabinet storage is provided, risk can be reduced by installing a range hood that projects horizontally a minimum of 5" (127mm) beyond the face of the cabinets.
- It is very important to keep 2 3/4" (70 mm) distance between the cooktop and an oven installed below it.

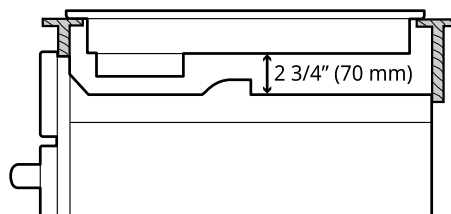

## Installing the Cooktop

### Electrical Connections

### Important Safety Instructions

- Be sure the cooktop is installed and grounded properly by a qualified installer or service technician.

- This cooktop must be electrically grounded in accordance with local codes or, in their absence, with the National Electrical Code ANSI/NFPA No. 70, latest edition in the United States.

### **⚠ WARNING**

- The electrical power to the cooktop must be shut off while line connections are being made. Failure to do so could result in serious injury or death.
- 

### **Providing the Electrical Connection**

- Install the junction box under the cabinet and run 120/240 or 120/208 Volt, AC wire from the main circuit panel.
- 

### **NOTE**

- DO NOT connect the wire to the circuit panel at this time.
- 

### **Electrical Requirements**

Observe all governing codes and local ordinances

- 1** A 3-wire or 4-wire single-phase 120/240 or 120/208 Volt, 60 Hz AC-only electrical supply is required on a separate circuit fused on both sides of the line (time-delay fuse or circuit breaker is recommended). DO NOT fuse neutral. The fuse size must not exceed the circuit rating of the appliance specified on the nameplate.
  - 2** 36" Radiant cooktop can consume up to 10500 W at 240 VAC. A 50 Amp circuit breaker with #8 AWG must be used. 30" Radiant cooktop can consume up to 7700 W at 240 VAC. A 40 Amp circuit breaker with #8 AWG must be used.
- 

### **⚠ WARNING**

- Do not use an extension cord with this appliance. Doing so may result in a fire, electrical shock, or other personal injury.
- 

### **NOTE**

- Wire sizes and connections must conform to the fuse size and rating of the appliance in accordance with the National Electrical Code ANSI/NFPA No. 70, latest edition, and local codes and ordinances.
- 

- 3** The appliance should be connected to the fused disconnect (or circuit breaker) box through flexible armored or nonmetallic

sheathed cable. The flexible armored cable extending from this appliance should be connected directly to the grounded junction box. The junction box should be located as shown in **Dimensions and Clearances** with as much slack as possible remaining in the cable between the box and the appliance, so it can be moved if servicing is ever necessary.

- 4** A suitable strain relief must be provided to attach the flexible armored cable to the junction box.

### **Electrical Connection**

Connect the flexible armored cable that extends from the surface unit to the junction box using a suitable strain relief at the point the armored cable enters the junction box. Then make the electrical connection as follows.

Electrical ground is required on this appliance.

This appliance is manufactured with a supply wire and a frame-connected green or bare copper grounding wire.

### **NOTE**

TO ELECTRICIAN:

- The armored cable leads supplied with the appliance are UL-listed for connection to larger gauge household wiring. The insulation of the leads is rated at temperatures much higher than the temperature rating of household wiring. The current-carrying capacity of the conductor wire is governed by the temperature rating of the insulation around the wire, rather than the wire gauge alone.
- 

### **⚠ WARNING**

- DO NOT ground to a gas supply pipe. DO NOT connect to electrical power supply until appliance is permanently grounded. Connect the ground wire before turning on the power.
  - This appliance is equipped with a copper conductor flexible cable. If connection is made to aluminum house wiring, use only special connectors which are approved for joining copper and aluminum wires in accordance with the National Electrical Code and local codes and ordinances. Improper connection of aluminum house wiring to copper leads can result in a short circuit or fire. Follow the connector manufacturer's recommended procedure closely.
-

## Where Local Codes Permit Connecting the Appliance-Grounding Conductor to the Neutral (White) Wire

Observe all governing codes and local ordinances.

- 1 Disconnect the power supply.
- 2 At the circuit breaker box, fuse box or junction box, connect appliance and power supply cable wires as shown.

### **⚠ WARNING**

- You may not ground the cooktop through the neutral (white) wire if cooktop is used in a new branch circuit installation (1996 NEC), mobile home, recreational vehicle, or where local codes do not permit grounding to the neutral (white) wire. When grounding to the neutral (white) wire is prohibited, you must use a 4-wire power supply cable. Failure to heed this warning may result in electrocution or other serious personal injury.

### 3-Wire Grounded Junction Box

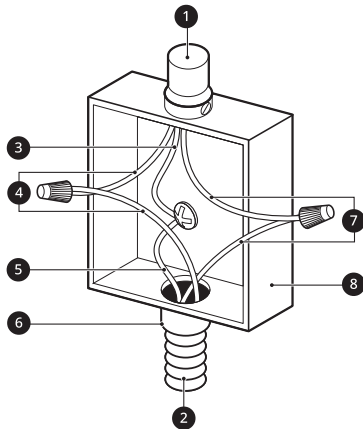

- 1 Cable from Power Supply
- 2 Cable from Cooktop
- 3 White Wire (Neutral)
- 4 Red Wires
- 5 Green Wire (Ground)
- 6 UL-listed Conduit Connector
- 7 Black Wires
- 8 Junction Box

## If Cooktop is Used in a New Branch Circuit Installation (1996 NEC), Mobile Home, Recreational Vehicle, or where Local Codes Do Not Permit Grounding to the Neutral (White) Wire

Observe all governing codes and local ordinances.

- 1 Disconnect the power supply.
- 2 At the circuit breaker box, fuse box or junction box, connect appliance and power supply cable wires as shown.

### **⚠ WARNING**

- If connecting to a 4-wire power supply cable electrical system, the appliance frame connected ground wire **MUST NOT** be connected to the neutral wire of the 4-wire electrical system.

### 4-Wire Grounded Junction Box

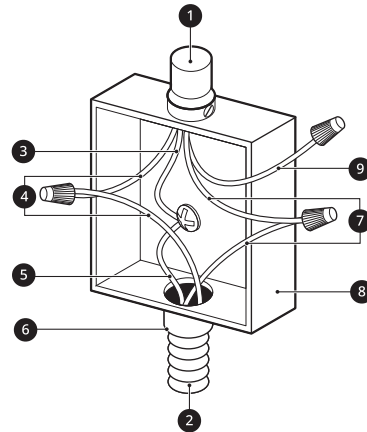

- 1 Cable from Power Supply
- 2 Cable from Cooktop
- 3 Ground Wire
- 4 Red Wires
- 5 Green Wire (Ground)
- 6 UL-listed Conduit Connector
- 7 Black Wires
- 8 Junction Box
- 9 White Wire (No Connection)

## Installing the Cooktop Unit

- 1 Visually inspect the cooktop for damage. Make sure all cooktop screws ❶ are tight (see below for locations).

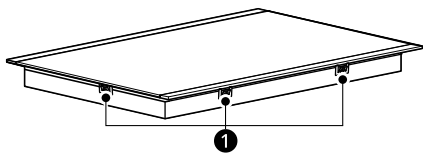

- 2 Check and prepare the installation location.
  - See **Dimensions and Clearances**.

- 3 Carefully lower the cooktop into the countertop cutout, making sure not to trap any wires.

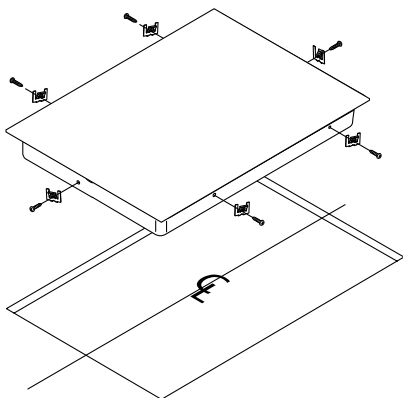

### NOTE

- Do not use caulking compound. The cooktop must be removable, should service be required.

- 4 Attach the retainer brackets ❶ to the bottom of the cooktop; then snug the bolts against the bottom of the countertop as shown.

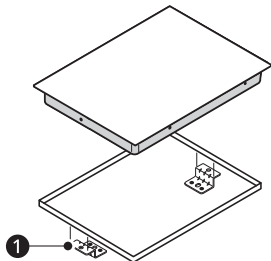

### NOTE

- The retainer brackets **MUST** be installed to meet local codes or, in their absence, with the National Electrical Code ANSI/NFPA No. 70, latest edition.

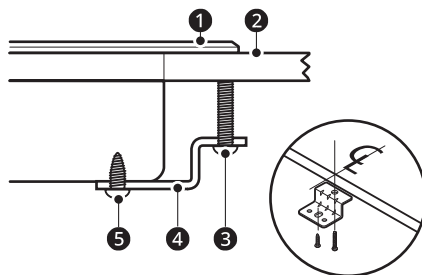

- ❶ Cooktop
- ❷ Countertop
- ❸ Bolt
- ❹ Retainer Brackets
- ❺ Type A Screw

## Alternative installation

### LSCE305ST

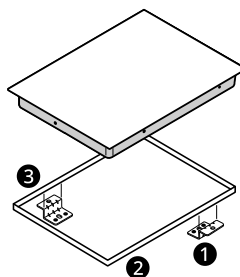

### LSCE365ST

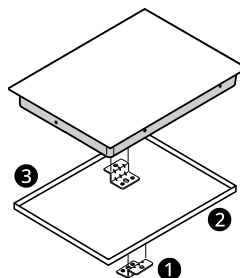

- ❶ Retainer Brackets
- ❷ Front
- ❸ Rear



---

## Final Check

Perform a final operational check of the cooktop, making sure the cooktop powers on properly and that each cooking zone operates correctly. Refer to the Operating Instructions in this guide for details.

# OPERATION

## Cookware

### Selecting Cookware

#### Pots and Pans

The better the pot, the better the cooking results.

- You can recognize good pots and pans by their bases. The base should be as thick and flat as possible.

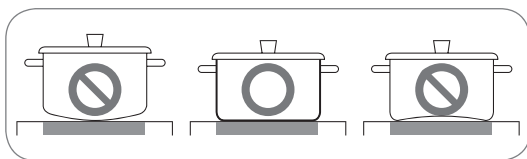

- Pots with aluminum or copper bases can cause metallic discoloring on the ceramic glass surface which is very difficult or impossible to remove.
- Be very careful when using cast iron pots or pots with damaged bases which are rough and or have burrs on them. Scratches can occur if they are slid across the surface.
- When cold, pot bases are normally bowed slightly inwards (concave). They should never be bowed outwards (convex).
- When using specialty cookware such as pressure cookers, simmering pans, or woks, follow the manufacturer's instructions and do not use a very thin pan.

#### Use Flat-Bottomed Cookware

Cookware must fully contact the surface of the cooking element. Use flat-bottomed pans sized to fit the cooking element and amount of food being prepared. Check for flatness by rotating a ruler across the bottom of the cookware.

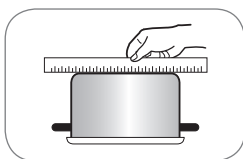

#### Avoiding Scratches

Use heavier gauge stainless steel cookware on your ceramic cooktop surface. This will help reduce the possibility of developing scratches on the ceramic surface.

Low-quality cookware can scratch the cooktop surface.

Cookware should always be lifted over the ceramic cooktop surface to prevent scratching. Over time, sliding ANY type of cookware over the ceramic cooktop may alter the overall appearance of the cooktop. Eventually, the buildup of scratches can make cleaning the surface difficult and degrade the overall appearance of the cooktop.

Scratches can also result from grains of sand (for example, after washing vegetables) which are dragged with the pot across the cooking surface.

#### Using Cookware

Always follow the recommendations for proper cookware type and size. In addition:

- Do not use dirty pans with grease buildup. Always use pans that are easy to clean after cooking, and make sure that the bottoms of the pans are clean and dry.
- When cooking with large amounts of liquid, use large pots so that nothing can boil over.
- Do not let pans boil dry. This may cause permanent damage in the form of breakage, fusion, or marring that can affect the ceramic cooktop. (This type of damage is not covered by your warranty.)
- Match the pan size and element to the amount of food being prepared.

#### Tips for Saving Energy

- Always position pots and pans before you switch on the element.
- Dirty elements and cookware use more electricity.
- Whenever possible, always have the lid firmly placed on the pots and pans so that they are completely covered.

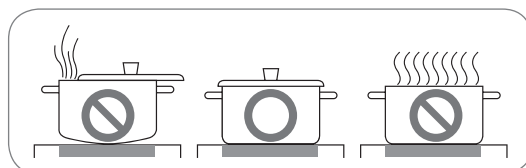

- Switch off the elements before the end of the cooking time to use the residual heat for keeping food warm or for melting.

- The base of the pot should be the same size as the element.

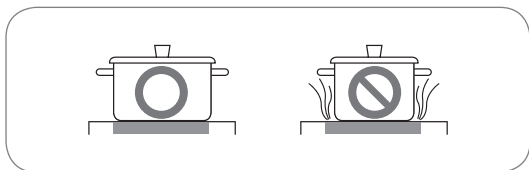

- Using a pressure cooker shortens cooking times by up to 50%.

# Control Panel

## Control Panel Features

### Locations of Surface Elements and Controls

The surface burner elements are positioned in the same locations on the cooktop and the control panel for ease of use.

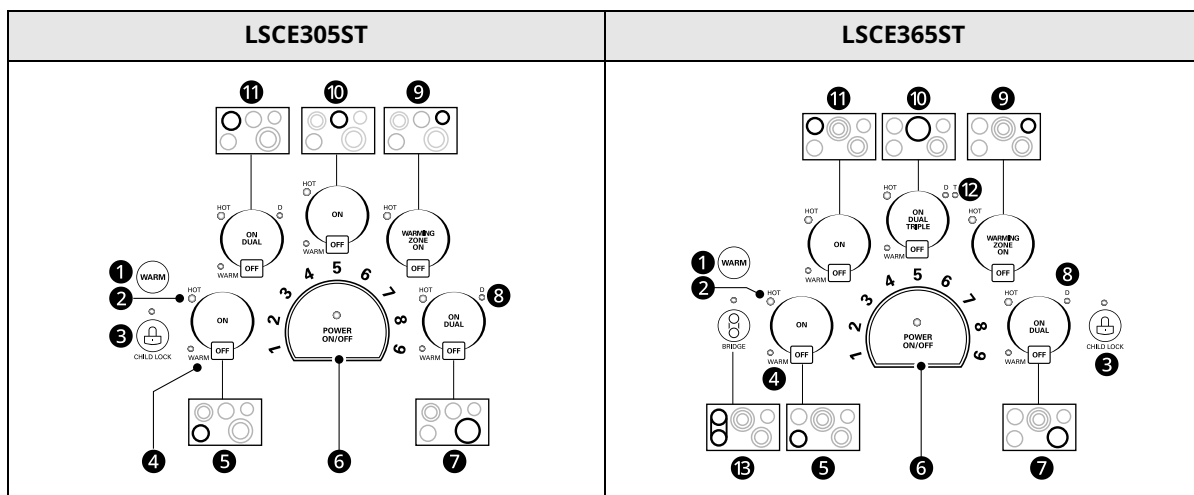

	LSCE305ST	LSCE365ST
①	<b>WARM:</b> Lowers the selected active element to the lowest setting.	
②	Hot surface indicator: The indicator light below <b>HOT</b> will illuminate when the cooking area is hot. It will remain on, even after the control is turned off, until the area has cooled.	
③	<b>CHILD LOCK:</b> Press and hold for 3 seconds to activate and deactivate the Child Lock function.	
④	<b>WARM:</b> Indicates that a surface burner has been set to Warm.	
⑤	Single element, left front element	Bridge element, left front element
⑥	<b>POWER ON/OFF:</b> Press <b>POWER ON/OFF</b> to turn the entire cooktop <b>ON</b> and <b>OFF</b> . When it is <b>ON</b> , the cooktop is in standby mode until an element is activated. Set the power level for an element by selecting a number from <b>1</b> to <b>9</b> in the element power settings.	
⑦	Dual element, right front element	
⑧	Dual element indicator	
⑨	Warming zone	
⑩	Single element, center rear element	Triple element, center rear element
⑪	Dual element, left rear element	Bridge element, left rear element
⑫	-	Triple element indicator
⑬	-	Bridge element, left element

### Before Using the Cooktop

Before using the cooktop for the first time, clean it

thoroughly with the included cleaner or ceramic cooktop cleaner according to the Care and Cleaning instructions in this guide. This will help

protect the ceramic surface and make future cleanup easier.

### ⚠ CAUTION

- Never use abrasive scrubbing pads or cleaners. They can cause permanent damage to the cooktop surface.

## Setting the Controls

To operate the control panel, press firmly with the flat part of your fingertip.

### First Use

The first time that power is supplied to the cooktop, the display for the controls lights for 1 second.

If you don't turn on the cooktop within 1 hour after power is supplied to the cooktop, the display for the controls flashes.

## Activating the Cooktop

To turn on the cooktop, press **POWER ON/OFF** for approximately 2 seconds. The indicator above the control will light.

To turn off the cooktop, press **POWER ON/OFF**. The indicator light above the control will turn off.

### NOTE

- After turning on the cooktop with the **POWER ON/OFF** control, you must select one of the elements within 15 seconds using the element **ON** controls. If no selection is made, the cooktop will turn off for safety.

## Selecting the Element

To select the desired element, press the **ON** control for that element.

The display for the selected element will light. The power level indicator lights flash, but no power level is set.

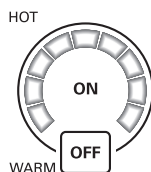

### NOTE

- Once the element has been selected with the **ON** control, the power level must be selected within

10 seconds with the element power settings. Otherwise, the element will turn off for safety.

## Setting the Power Level

The power level for the selected element can be set from **1** to **9**.

### To select the power level:

- Select the number on the element power settings for the active element to adjust the power level from **1** to **9**
- Selecting a number on the element power settings activates the element. The indicator lights flash once and lock in your selection.

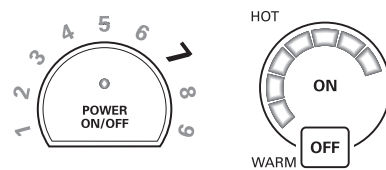

### NOTE

- If a power level is not selected, the element will turn off after 10 seconds.

### To adjust the power level:

- Select **ON** for the desired element.
- Select a number in the element power settings to adjust the power level. If a power level is not selected after 10 seconds, the element's power level remains the same.

### To turn off the element:

- After cooking is complete, press **OFF** for the selected element.
- The display for the corresponding element turns off.
- If the **POWER ON/OFF** control is selected, all elements are turned off.

## ⚠ WARNING

- Your cooktop has a residual heat indicator for each element. This indicator will warn that this area has been used and is still giving off enough heat to cause burns. Avoid touching the element when this indicator is on. Although the cooktop is off, the light will stay lit until the cooktop has cooled down.

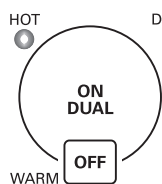

Setting	Function	Used for
9	Fast heating	Bringing liquids to a boil.
7-9	Heating, browning, deep fat frying	Browning meats, heating oil for deep-fat frying, sautéing, maintaining a fast boil for large amounts of liquids.
6-7	Roasting, frying	Frying meats, chops, pancakes, sausages, eggs.
4-5	Boiling, general cooking	Cooking larger quantities, soups and stews, steaming potatoes, cooking meat stock or bouillon.
3-4	Steaming	Steaming vegetables, braising meats.
2-3	Simmering	Simmering rice or milk-based dishes, steaming smaller quantities of potatoes and vegetables, heating ready-to-serve meals.
1-2 Warm	Melting	Fluffy omelettes, keeping dishes warm, melting butter or chocolate.

## NOTE

- These settings are recommended guidelines for cooking. You may need to adjust the power level for the type of food and pan.

## Warm

The cooktop has a **WARM** setting feature that can be used on all elements except the warming zone element.

To activate:

Press the **ON** control to activate the desired element and press the **WARM** control. The selected element is set to the **LOW** setting. The indicator light above **WARM** turns on.

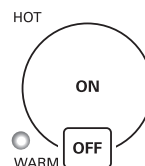

To change the power level:

Press the element's **ON** control and select a new number on the element power settings. The indicator light above **WARM** turns off.

## Using the Warming Zone

Use the warming zone to keep cooked foods warm, such as vegetables, gravies and oven-safe dinner plates.

Do not use the warming zone to cook food. Attempting to cook uncooked or cold food on the warming zone could result in a food-borne illness.

## To activate the warming zone:

Press the **WARMING ZONE ON** control. Set the desired power level on the element power settings.

## Warming Level Guide

Settings	Used
1-2	Pastries, breads, breakfast foods, eggs, delicate foods
3-5	Cream-based soups, stews, vegetables, meats
6-8	Sauces, gravies
9	Hot beverages, soups

## NOTE

- All foods should be covered with a lid or aluminum foil to maintain food quality.
- When warming pastries and bread, the cover should have an opening to allow moisture to escape.

- Do not use plastic wrap to cover foods. Plastic may melt onto the cooktop surface and be very difficult to clean.
- Use only cookware and dishes recommended as safe for cooktop use.
- Always use potholders when removing food from the warming zone as cookware and plates will be hot.
- Never warm food for longer than one hour (eggs for 30 minutes), as food quality may deteriorate.
- Do not heat cold food on the warming zone.
- The quantity and type of food being held may affect the required heat setting
- Do not use large cookware or large amounts of food as this may cause uneven heating.
- Always hold food at proper food temperatures. USDA recommends food temperatures between 140 °F - 170 °F (except pastries).

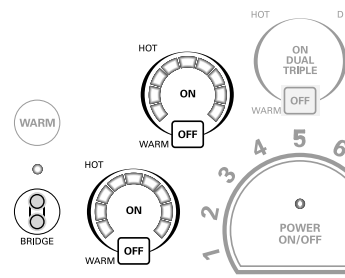

- 2 Select a number in the element power settings to adjust the power level. If a power level is not selected after 10 seconds, the element's power level remains the same.

### To turn off the bridge element:

- 1 After cooking is complete, press **OFF** for one of the left elements.
- 2 The display for the corresponding element turns off.
- 3 If the **POWER ON/OFF** control is selected, all elements are turned off.

## Using the Bridge Elements

This feature is only available on some models.

The three left cooking zones can be used together as a single cooking zone using the bridge function. This allows you to cook with larger oblong pans.

The bridge function can only be activated when the left front cooking zone and the left rear cooking zones are **OFF**.

### To activate the bridge element:

- 1 Press the **BRIDGE** control. The indicator above the control turns on.
- 2 The power level indicator lights for the left front and left rear bridge elements flash. Select the desired power level.

### To adjust the power level:

- 1 Select **ON** or **BRIDGE** for one of the left elements.

## Using the Triple Elements

This feature is only available on some models.

The triple element, located in the center position, offers three different sized elements to accommodate different pan sizes.

### To activate the triple element:

- 1 Press the **ON** control. The inner element will activate.

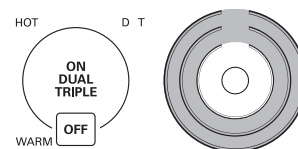

- 2 Press the **ON** control again to activate the dual element. The indicator light below the **D** (Dual) turns on.

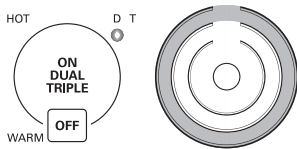

- 3** Press the **ON** control again to activate the entire triple element. The indicator lights below the **D** (Dual) and **T** (Triple) turn on.

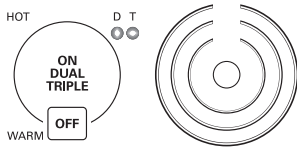

- 4** Select the desired power level.

## Using the Dual Elements

The dual element, located in the right front position, offers two different sized elements to accommodate different pan sizes. Use one or two sections of the element to accommodate different pan sizes.

To activate the dual element:

- 1** Press the **ON** control. The innermost element activates.

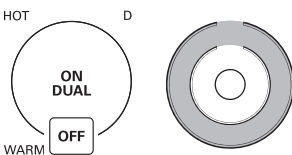

- 2** Press the **ON** control again to activate the entire dual element. The indicator light below the **D** (Dual) turns on.

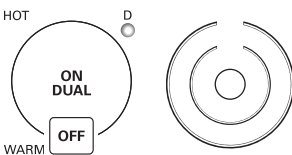

- 3** Select the desired power level.

## Using Child Lock

You can lock the entire cooktop at any time when it is not in use. Locking the cooktop will prevent elements from being turned on accidentally.

## Setting Child Lock

- 1** The cooktop must be off to set the **CHILD LOCK** function. If it is not off, press and hold **POWER ON/OFF** for approximately 2 seconds. The indicator above the **POWER ON/OFF** control turns off.
- 2** Press and hold the **CHILD LOCK** control for 3 seconds. The indicator light above the **CHILD LOCK** control will turn on to indicate that the cooktop is locked.



## Canceling Child Lock

To unlock the cooktop, press and hold the **CHILD LOCK** control for 3 seconds. The indicator light turns off and the cooktop can now be used normally.

## Other Functions

### Automatic Shutoff

If an element is in constant use for more than 17 hours and the control setting is not changed, the element will shut off automatically.

### Automatic Power Level Control

The power level displayed may be different from the actual power level at the high temperature range. To prevent the cooktop from overheating, the power level is controlled automatically.



# MAINTENANCE

## Care and Cleaning

Make sure that the electrical power is off and all surfaces are cool before cleaning any part of the cooktop.

### Cleaning the Cooktop

#### Normal Daily Use Cleaning

##### **⚠ CAUTION**

- If any sugar or food containing sugar spills, or plastic or foil melts on the cooktop, remove the material IMMEDIATELY with a metal razor scraper while the cooking surface is still hot to avoid the risk of damage to the glass-ceramic surface. When used correctly, the scraper will not damage the cooktop surface. For your safety, please use an oven mitt or pot holder while scraping the hot cooking surface.
- If water or food containing water spills, remove the spill IMMEDIATELY with a dry paper towel.
- Do not use scrub pads or abrasive cleaning pads. They may damage your cooktop surface.
- For your safety, wear an oven mitt or pot holder while cleaning the hot cooking surface.

Use ceramic cooktop cleaner on the glass cooktop. Other creams may not be as effective or may scratch, damage or stain the cooktop surface.

To maintain and protect the surface of the glass cooktop, follow these steps:

- 1** Before using the cooktop for the first time, clean it with a ceramic cooktop cleaner. This helps protect the top and makes cleanup easier.
- 2** Use ceramic cooktop cleaner daily to help keep the cooktop looking new. Always allow the cooktop to cool before using ceramic cooktop cleaner.
- 3** Shake the cleaning cream well. Apply a few drops of cleaner directly to the cooktop.
- 4** Use a paper towel to clean the entire cooktop surface.

- 5** Rinse with clear water and use a dry cloth or paper towel to remove all cleaning residue.

##### NOTE

- Any damage or failure of the product resulting from the items below may not be covered under the LIMITED WARRANTY.
  - Sugary spillovers (such as preserves, ketchup, tomato sauce, jellies, fudge, candy, syrups, or chocolate) or melted plastics can cause pitting on the surface of your cooktop.
  - If food or water containing calcium (such as baking powder, wine, milk, spinach, or broccoli) is spilled on the cooktop, it can permanently stain or discolor the surface.

#### Burned-On Residue

- 1** While the cooktop is still warm, remove any burnt on deposits or spilled food from the glass-ceramic cooking surface with a suitable metal razor scraper. To prevent burns, wear an oven mitt or pot holder while using the metal scraper.

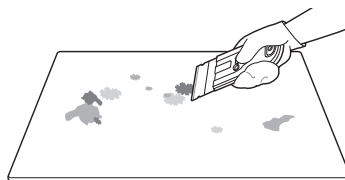

##### NOTE

- Do not use a dull or nicked blade.
  - Hold the scraper at approximately a 30° angle to the cooktop.
  - The razor scraper will not damage the markings on the cooking surface.
- 2** When the cooking surface has completely cooled, apply a few dime-sized dabs of a glass-ceramic cooktop cleaner in each burner area. Work the cleaning cream over the cooktop surface with a damp paper towel. Leave the cleaner on for 10 minutes before rinsing it off.





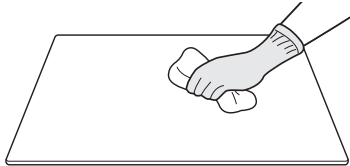



**3** Rinse with clean water and wipe the cooktop surface with a clean, dry cloth.



### Maintaining the Cooktop

**⚠ CAUTION**

- Do not use chlorine bleach, ammonia, or other cleaners not specifically recommended for use on glass-ceramic cooktops.
- Let your glass-ceramic cooking surface cool off before cleaning.

	Wipe off with a damp towel and mild detergent	Use a metal scraper	Apply cooktop cleaning cream. Rub with a towel.	Rinse with a damp towel, then wipe dry.
Regular (Recommended after each use)				
Occasional (Recommended every week)				
Thorough (Recommended for tough stains or burnt-on food)				

**NOTE**

- For additional product information, visit our website at [www.lg.com](http://www.lg.com)

- Do not use cookware if there is foreign matter on the cooktop surface. Always clean the cooktop surface before cooking.

### Metal Marks and Scratches

**⚠ CAUTION**

- Cookware with rough or uneven bottoms can mark or scratch the cooktop surface.

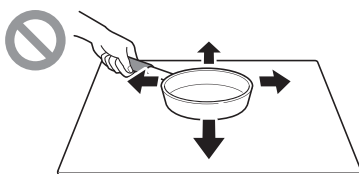

- Do not slide metal or glass across the cooktop surface.
- Do not use cookware with any dirt build-up on the bottom.

**NOTE**

- Any damage or failure of the product resulting from the items below may not be covered under the LIMITED WARRANTY.
  - Be careful not to slide pots and pans across the cooktop. Doing so will leave metal markings on the cooktop surface. To help remove these marks, use a ceramic cooktop cleaner with a cleaning pad for ceramic cooktops.
  - If pots with a thin overlay of aluminum or copper are allowed to boil dry, the overlay may leave a black discoloration on the cooktop. This should be removed immediately before heating again or the discoloration may be permanent.

# TROUBLESHOOTING

## Before Calling for Service

Before calling for service, review this list. It may save you time and expense. This list includes common occurrences that are not the result of a defect in workmanship or materials.

### Parts and Features

Problem	Possible Cause & Solution
<b>Cooktop does not work</b>	<b>Cooktop controls are locked.</b> <ul style="list-style-type: none"> <li>• See Using Child Lock to turn off the Child Lock feature.</li> </ul>
	<b>Circuit breaker has tripped or fuse is blown.</b> <ul style="list-style-type: none"> <li>• Reset the circuit breaker.</li> </ul>
	<b>Power outage.</b> <ul style="list-style-type: none"> <li>• Check house lights to confirm power outage.</li> </ul>
	<b>Installation wiring not complete.</b> <ul style="list-style-type: none"> <li>• Contact the installer or dealer.</li> </ul>
<b>Cooktop does not heat</b>	<b>Incorrect element selected.</b> <ul style="list-style-type: none"> <li>• Make sure the correct control is ON for the element being used.</li> </ul>
	<b>No power to cooktop.</b> <ul style="list-style-type: none"> <li>• See “Cooktop does not work” above.</li> </ul>
<b>Elements turn off while cooking.</b>	<b>Cooktop inner temperature is too high.</b> <ul style="list-style-type: none"> <li>• Check that cooktop has been installed according to the installation instructions.</li> </ul>
<b>Elements do not get hot enough.</b>	<b>Control panel may not be set properly.</b> <ul style="list-style-type: none"> <li>• Check the power level.</li> </ul>
	<b>Cookware may not be the correct size or may have a flat bottom.</b> <ul style="list-style-type: none"> <li>• Use the recommended cookware. See Cookware section.</li> </ul>
<b>A fan sound can be heard.</b>	<b>Cooktop inner temperature is high.</b> <ul style="list-style-type: none"> <li>• This is normal. The cooling fan will run when any element is turned on. With heavy use the fan may continue to run after the controls are turned off until the cooktop has cooled.</li> </ul>

## Control Panel

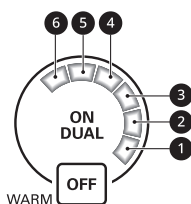

Problem	Possible Cause & Solution
Flashing ① Flashing ①, ② Flashing ①, ②, ③	<b>There is a fault with the thermistor or micom.</b> <ul style="list-style-type: none"> <li>Turn the cooktop off using the <b>POWER ON/OFF</b>. Turn cooktop back on using the <b>POWER ON/OFF</b>.</li> </ul>
Flashing ①, ②, ③, ④	<b>Food spill/soil on the control panel</b> <ul style="list-style-type: none"> <li>Clean the surface.</li> </ul> <b>Object placed on the control panel</b> <ul style="list-style-type: none"> <li>Remove object from the control panel.</li> </ul> <b>Controls pressed for too long.</b> <ul style="list-style-type: none"> <li>If any one of the controls is pressed for more than 10 seconds continuously, this error is displayed.</li> <li>If water or a metal object is placed on the control panel, this error is displayed.</li> <li>Turn the cooktop off using the <b>POWER ON/OFF</b>. Turn cooktop back on using the <b>POWER ON/OFF</b>.</li> </ul>
Flashing ①, ②, ③, ④, ⑤	<b>There is a fault with the display.</b> <ul style="list-style-type: none"> <li>Turn the cooktop off using the <b>POWER ON/OFF</b>. Turn cooktop back on using the <b>POWER ON/OFF</b>.</li> </ul>
Flashing ①, ②, ③, ④, ⑤, ⑥	<b>Low voltage detection</b> <ul style="list-style-type: none"> <li>This indicates low voltage to the cooktop. Call a licensed electrician.</li> </ul>

# LIMITED WARRANTY

## USA

### TERMS AND CONDITIONS

**ARBITRATION NOTICE: THIS LIMITED WARRANTY CONTAINS AN ARBITRATION PROVISION THAT REQUIRES YOU AND LG ELECTRONICS (“LG”) TO RESOLVE DISPUTES BY BINDING ARBITRATION INSTEAD OF IN COURT, UNLESS YOU CHOOSE TO OPT OUT. IN ARBITRATION, CLASS ACTIONS AND JURY TRIALS ARE NOT PERMITTED. PLEASE SEE THE SECTION TITLED “PROCEDURE FOR RESOLVING DISPUTES” BELOW.**

Should your LG Radiant Cooktop (“Product”) fail due to a defect in materials or workmanship under normal and proper use, during the warranty period set forth below, LG will, at its option, repair or replace the Product. This limited warranty is valid only to the original retail purchaser of the Product (“You”) and applies only when purchased lawfully and used within the United States including U.S. Territories.

Warranty Period	Scope of Warranty	HOW SERVICE IS HANDLED
Two (2) years from date of original retail purchase	Parts and Labor (internal / functional parts only)	LG will provide, free of charge, all labor and in-home service to replace defective part(s).

- Replacement Products and parts are warranted for the remaining portion of the original warranty period or ninety (90) days, whichever is greater.
- Replacement Products and parts may be new, reconditioned, refurbished, or otherwise factory remanufactured.
- Replaced Product or part(s) will be the property of LG.
- Proof of original retail purchase specifying the Product model and date of purchase is required to obtain warranty service under this limited warranty.

**EXCEPT TO THE EXTENT PROHIBITED BY APPLICABLE LAW, ANY IMPLIED WARRANTY OF MERCHANTABILITY OR FITNESS FOR A PARTICULAR PURPOSE ON THE PRODUCT IS LIMITED IN DURATION TO THE DURATION OF THE ABOVE LIMITED WARRANTY. UNDER NO CIRCUMSTANCES SHALL LG OR ITS U.S. DISTRIBUTORS/DEALERS BE LIABLE FOR ANY INDIRECT, INCIDENTAL, CONSEQUENTIAL, SPECIAL, OR PUNITIVE DAMAGES, INCLUDING, WITHOUT LIMITATION, LOST GOODWILL, LOST REVENUES OR PROFITS, WORK STOPPAGE, IMPAIRMENT OF OTHER GOODS, COST OF REMOVAL AND REINSTALLATION OF THE PRODUCT, LOSS OF USE, OR ANY OTHER DAMAGES WHETHER BASED IN CONTRACT, TORT, OR OTHERWISE. LG’S TOTAL LIABILITY, IF ANY, SHALL NOT EXCEED THE PURCHASE PRICE PAID BY YOU FOR THE PRODUCT.**

**SOME STATES DO NOT ALLOW THE EXCLUSION OR LIMITATION OF INCIDENTAL OR CONSEQUENTIAL DAMAGES OR LIMITATIONS ON HOW LONG AN IMPLIED WARRANTY LASTS, SO THE ABOVE EXCLUSIONS OR LIMITATIONS MAY NOT APPLY TO YOU. THIS LIMITED WARRANTY GIVES YOU SPECIFIC LEGAL RIGHTS AND YOU MAY ALSO HAVE OTHER RIGHTS THAT VARY FROM STATE TO STATE.**

### THIS LIMITED WARRANTY DOES NOT COVER:

- Service trips to deliver, pick up, or install, educate how to operate, correct wiring, or correct unauthorized repairs.
- Damage or failure of the Product to perform during power failures and interrupted or inadequate electrical service.
- Damage or failure of the Product caused by leaky or broken water pipes, frozen water pipes, restricted drain lines, inadequate or interrupted water supply or inadequate supply of air.
- Damage or failure of the Product resulting from operating the Product in a corrosive atmosphere or contrary to the Product owner’s manual.

- Damage or failure of the Product caused by accidents, pests and vermin, lightning, wind, fire, floods, acts of nature, or any other causes beyond the control of LG.
- Damage or failure of the Product caused by unauthorized modification or alteration, or if the Product is used for other than the intended purpose, or any water leakage where the Product was not properly installed.
- Damage or failure of the Product caused by incorrect electrical current, voltage, or plumbing codes.
- Damage or failure of the Product caused by transportation, storage, and/or handling, including scratches, dents, chips, and/or other damage to the finish of the Product, unless such damage is reported within one (1) week of delivery.
- Damage or failure of the Product resulting from misuse, abuse, improper installation, repair, or maintenance. Improper repair includes the use of parts not authorized by LG. Improper installation or maintenance includes installation or maintenance contrary to the Product owner's manual.
- Damage or failure of the Product caused by the use of parts, components, accessories, consumable cleaning products, or any other products or services that were not authorized by LG.
- Damage or missing items to any display or open box Product.
- Refurbished Product or any Product sold "As Is", "Where Is", "With all Faults", or similar disclaimer.
- Products with original serial numbers that have been removed, altered, or cannot be readily determined.
- Increases in utility costs and additional utility expenses.
- Any noises associated with normal operation.
- Products used for other than normal and proper household use (e.g., commercial or industrial use) or contrary to the Product owner's manual.
- Costs associated with removal and reinstallation of the Product for repairs, or the removal and reinstallation of the Product if it is installed in an inaccessible location or not installed in accordance with the Product Owner's manual.
- Accessories, removable components, or consumable parts (e.g. Shelves, door bins, drawers, water/air filters, racks, light bulbs, batteries, etc., as applicable), except for internal/functional parts covered under this limited warranty.

**The cost of repair or replacement under these excluded circumstances shall be borne by You.**

TO OBTAIN WARRANTY SERVICE AND ADDITIONAL INFORMATION

Call 1-800-243-0000 and select the appropriate option from the menu.

Or visit our website at <http://www.lg.com>

Or by mail: LG Electronics Customer Service P.O. Box 240007 Huntsville, AL 35813 ATTN: CIC

### PROCEDURE FOR RESOLVING DISPUTES:

ALL DISPUTES BETWEEN YOU AND LG ARISING OUT OF OR RELATING IN ANY WAY TO THIS LIMITED WARRANTY OR THE PRODUCT SHALL BE RESOLVED EXCLUSIVELY THROUGH BINDING ARBITRATION, AND NOT IN A COURT OF GENERAL JURISDICTION. BINDING ARBITRATION MEANS THAT YOU AND LG ARE EACH WAIVING THE RIGHT TO A JURY TRIAL AND TO BRING OR PARTICIPATE IN A CLASS ACTION.

**Definitions.** For the purposes of this section, references to "LG" mean LG Electronics U.S.A., Inc., its parents, subsidiaries and affiliates, and each of their officers, directors, employees, agents, beneficiaries, predecessors in interest, successors, assigns and suppliers; references to "dispute" or "claim" shall include any dispute, claim or controversy of any kind whatsoever (whether based in contract, tort, statute, regulation, ordinance, fraud, misrepresentation or any other legal or equitable theory) arising out of or relating in any way to the sale, condition or performance of the product or this Limited Warranty.

**Notice of Dispute.** In the event you intend to commence an arbitration proceeding, you must first notify LG in writing at least 30 days in advance of initiating the arbitration by sending a letter to LG at LG Electronics, USA, Inc. Attn: Legal Department- Arbitration 111 Sylvan Avenue, Englewood Cliffs, NJ 07632. You and LG agree to engage in good faith discussions in an attempt to amicably resolve your claim. The notice must provide your name, address, and telephone number; identify the product that is the subject of

the claim; and describe the nature of the claim and the relief being sought. If you and LG are unable to resolve the dispute within 30 days, either party may proceed to file a claim for arbitration.

**Agreement to Binding Arbitration and Class Action Waiver.** Upon failure to resolve the dispute during the 30 day period after sending written notice to LG, you and LG agree to resolve any claims between us only by binding arbitration on an individual basis, unless you opt out as provided below. Any dispute between you and LG shall not be combined or consolidated with a dispute involving any other person's or entity's product or claim. More specifically, without limitation of the foregoing, any dispute between you and LG shall not under any circumstances proceed as part of a class or representative action. Instead of arbitration, either party may bring an individual action in small claims court, but that small claims court action may not be brought on a class or representative basis.

**Arbitration Rules and Procedures.** To begin arbitration of a claim, either you or LG must make a written demand for arbitration. The arbitration will be administered by the American Arbitration Association ("AAA") and will be conducted before a single arbitrator under the AAA's Consumer Arbitration Rules that are in effect at the time the arbitration is initiated (referred to as the "AAA Rules") and under the procedures set forth in this section. The AAA Rules are available online at [www.adr.org/consumer](http://www.adr.org/consumer). Send a copy of your written demand for arbitration, as well as a copy of this provision, to the AAA in the manner described in the AAA Rules. You must also send a copy of your written demand to LG at LG Electronics, USA, Inc. Attn: Legal Department- Arbitration 111 Sylvan Avenue, Englewood Cliffs, NJ 07632. If there is a conflict between the AAA Rules and the rules set forth in this section, the rules set forth in this section will govern. This arbitration provision is governed by the Federal Arbitration Act. Judgment may be entered on the arbitrator's award in any court of competent jurisdiction. All issues are for the arbitrator to decide, except that issues relating to the scope and enforceability of the arbitration provision and to the arbitrability of the dispute are for the court to decide. The arbitrator is bound by the terms of this provision.

**Governing Law.** The law of the state of your residence shall govern this Limited Warranty and any disputes between us except to the extent that such law is preempted by or inconsistent with applicable federal law.

**Fees/Costs.** You do not need to pay any fee to begin an arbitration. Upon receipt of your written demand for arbitration, LG will promptly pay all arbitration filing fees to the AAA unless you seek more than \$25,000 in damages, in which case the payment of these fees will be governed by the AAA Rules. Except as otherwise provided for herein, LG will pay all AAA filing, administration and arbitrator fees for any arbitration initiated in accordance with the AAA Rules and this arbitration provision. If you prevail in the arbitration, LG will pay your attorneys' fees and expenses as long as they are reasonable, by considering factors including, but not limited to, the purchase amount and claim amount. Notwithstanding the foregoing, if applicable law allows for an award of reasonable attorneys' fees and expenses, an arbitrator can award them to the same extent that a court would. If the arbitrator finds either the substance of your claim or the relief sought in the demand is frivolous or brought for an improper purpose (as measured by the standards set forth in Federal Rule of Civil Procedure 11(b)), then the payment of all arbitration fees will be governed by the AAA Rules. In such a situation, you agree to reimburse LG for all monies previously disbursed by it that are otherwise your obligation to pay under the AAA Rules. Except as otherwise provided for, LG waives any rights it may have to seek attorneys' fees and expenses from you if LG prevails in the arbitration.

**Hearings and Location.** If your claim is for \$25,000 or less, you may choose to have the arbitration conducted solely on the basis of (1) documents submitted to the arbitrator, (2) through a telephonic hearing, or (3) by an in-person hearing as established by the AAA Rules. If your claim exceeds \$25,000, the right to a hearing will be determined by the AAA Rules. Any in-person arbitration hearings will be held at a location within the federal judicial district in which you reside unless we both agree to another location or we agree to a telephonic arbitration.

**Opt Out.** You may opt out of this dispute resolution procedure. If you opt out, neither you nor LG can require the other to participate in an arbitration proceeding. To opt out, you must send notice to LG no later than 30 calendar days from the date of the first consumer purchaser's purchase of the product by either: (i) sending an e-mail to [optout@lge.com](mailto:optout@lge.com), with the subject line: "Arbitration Opt Out" or (ii) calling 1-800-980-2973. You must include in the opt out e-mail or provide by telephone: (a) your name and address; (b) the date on which the product was purchased; (c) the product model name or model number; and (d) the serial number (the serial number can be found (i) on the product; or (ii) online by accessing <https://www.lg.com/us/support/repair-service/schedule-repair-continued> and clicking on "Find My Model & Serial Number").

## 32 LIMITED WARRANTY

---

You may only opt out of the dispute resolution procedure in the manner described above (that is, by e-mail or telephone); no other form of notice will be effective to opt out of this dispute resolution procedure. Opting out of this dispute resolution procedure will not affect the coverage of the Limited Warranty in any way, and you will continue to enjoy the full benefits of the Limited Warranty. If you keep this product and do not opt out, then you accept all terms and conditions of the arbitration provision described above.











**LG**

Life's Good

LG Customer Information Center

For inquiries or comments,  
visit **www.lg.com** or call:

**1-800-243-0000** U.S.A.

**1-888-542-2623** CANADA

Register your product Online!

**www.lg.com**