

ADW24PF

# COOK LIKE A GOD

24IN. BUILT IN DISHWASHER

**THOR**  
K I T C H E N<sup>®</sup>

USE & CARE MANUAL

USE AND CARE MANUAL

# 24IN. BUILT IN DISHWASHER

ADW24PF

**THOR**  
K I T C H E N<sup>®</sup>

# TABLE OF CONTENTS

<b>DISHWASHER SAFETY .....</b>	<b>3</b>
<b>OPERATING REQUIREMENTS.....</b>	<b>7</b>
Location Requirements.....	7
Water Supply Requirements.....	7
<b>PARTS AND FEATURES .....</b>	<b>8</b>
Filter System .....	9
Smart Wash System .....	9
Adjustable Upper Rack .....	10
<b>START UP GUIDE .....</b>	<b>11</b>
How your Dishwasher Cleans .....	11
Before Using Your Dishwasher.....	11
Using Your New Dishwasher .....	11
<b>CONTROLS .....</b>	<b>12</b>
Cycle and Option Charts .....	15
Loading Suggestions .....	16
Upper Rack .....	17
Load Upper Rack.....	18
Lower Rack .....	19
Loading Silverware .....	21
Recommended Load Patterns.....	22
<b>DISHWASHER USE .....</b>	<b>24</b>
Proper Use of Rinse Aid.....	25
Washing Special Items .....	27
<b>DISHWASHER CARE .....</b>	<b>28</b>
Storing.....	30
<b>TROUBLESHOOTING .....</b>	<b>31</b>
Error Codes.....	36
<b>WARRANTY.....</b>	<b>37</b>

# DISHWASHER SAFETY

**YOUR SAFETY AND THE SAFETY OF OTHERS ARE VERY IMPORTANT**

To prevent injury to the user or other people and property damage, the instructions shown here must be followed. Incorrect operation due to ignoring of instructions may cause harm or damage, including death.

The level of risk is shown by the following indications.



This symbol indicates the possibility of death or serious injury.



This symbol indicates the possibility of injury or damage to property.



This symbol indicates the possibility of dangerous voltage constituting a risk of electrical shock is present that could result in death or serious injury.



## WARNING/GROUNDING INSTRUCTIONS

**Improper connection of the equipment-grounding conductor can result in a risk of electric shock. Check with a qualified electrician or service representative if you are in doubt whether the appliance is properly grounded. Do not modify the plug if provided with the appliance. If the plug will not fit the outlet, have a proper outlet installed by a qualified electrician.**

### ***For a grounded, cord-connected appliance:***

This appliance must be grounded. In the event of a malfunction or breakdown, grounding will reduce the risk of electric shock by providing a path of least resistance for electric current. If this appliance is equipped with a cord having an equipment-grounding conductor and a grounding plug, the plug must be plugged into an appropriate outlet that is installed and grounded in accordance with all local codes and ordinances.

### ***For a permanently connected appliance:***

This appliance must be connected to a grounded metal, permanent wiring system, or an equipment-grounding conductor must be run with the circuit conductors and connected to the equipment-grounding terminal or lead on the appliance.

# IMPORTANT SAFETY INSTRUCTIONS



## WARNING

When using your dishwasher, follow basic precautions, including the following:

- Read all instructions before using the dishwasher.
- Use the dishwasher only for its intended function.
- Use only detergents or rinse/wetting agents recommended for use in a dishwasher and keep them out of the reach of children.
- When loading items to be washed:
  - Locate sharp items so that they are not likely to damage the door seal.
  - Load sharp knives with the handles up to reduce the risk of cut-type injuries.
- Do not wash plastic items unless they are marked “Dishwasher Safe” or the equivalent. For plastic items not so marked, check the manufacturer’s recommendations.
- Items that are not dishwasher safe may melt and create a potential fire hazard.
- Do not touch the heating element during or immediately after use.
- Do not operate your dishwasher unless all enclosure panels are properly in place.

- Do not tamper with controls.
- Do not abuse, sit on, or stand on the dishwasher door, or dish racks.
- To reduce the risk of injury, do not allow children to play in or on a dishwasher.
- Under certain conditions, hydrogen gas may be produced in a hot-water system that has not been used for two weeks or more. **HYDROGEN GAS IS EXPLOSIVE.** If the hot-water system has not been used for such a period, before using the dishwasher turn on all hot-water faucets and let the water flow from each for several minutes. This will release any accumulated hydrogen gas. As the gas is flammable, do not smoke or use an open flame during this time.
- Severe product damage and/or injury could result from the use of unqualified service technicians or non-original replacement parts. All repairs must be performed by a qualified service technician using only original equipment factory replacement parts.
- Do not store or use combustible materials, gasoline or other flammable vapors and liquids in the vicinity of this or any other appliance.
- Keep young children and infants away from dishwasher when it is operating.
- Do not use the dishwasher if it has a damaged power line or plug, and do not plug the dishwasher into a damaged outlet. Failure to observe these instructions may result in electrical shock.
- This manual does not cover every possible condition or situation that may occur.
- Remove the door to the washing compartment when removing an old dishwasher from service or discarding it.

## SAVE THESE INSTRUCTIONS

**THIS APPLIANCE IS FOR HOUSEHOLD USE ONLY**

### **WARNING**



#### **Tip Over Hazard**

- Do not use dishwasher until completely installed.
- Do not push down on open door.
- Doing so can result in serious injury or cuts.

## State of California Proposition 65 Warnings:



**WARNING:** Cancer and Reproductive Harm  
-[www.P65Warnings.ca.gov](http://www.P65Warnings.ca.gov).



### WARNING

#### Suffocation Hazard

- Before you throw away your old appliance, remove the door or lid so that children cannot hide or get trapped inside your old appliance.
- Failure to follow these instructions can result in death or brain damage.



### CAUTION

- Never use harsh chemicals to clean your dishwasher. Some chloride-containing products can damage your dishwasher and may present health hazards!
- Never use steam cleaning products to clean your dishwasher. The manufacturer will not be responsible for the possible damages or consequences.
- To avoid possible dishwasher damage, do not use harsh chemicals, abrasive cleaners, scouring pads (metal or plastic), or abrasive cloths/paper towels to clean your dishwasher's exterior door panel. Your dishwasher's exterior door panel can be damaged by doing so.
- It is highly recommended that the user become familiar with the procedure to shut off the incoming water supply and the procedure to shut off the incoming power supply. See the Installation Instructions or contact your installer for more information.
- If the dishwasher drains into a food disposer, make sure disposer is completely empty before running dishwasher.
- NSF/ANSI 184 Certified residential dishwashers are not intended for licensed food establishments.
- Protect your dishwasher from the elements. Protect against freezing to avoid possible damage to the fill valve. Damage caused by freezing is not covered by the warranty.
- Not for outdoor use.

# OPERATING REQUIREMENTS

## ELECTRICAL REQUIREMENTS



### WARNING

#### Electrical Shock Hazard

- Electrically ground dishwasher.
- Connect ground wire to green ground connector in terminal box.
- Do not use an extension cord.
- Failure to follow these instructions can result in death, fire, or electrical shock.

This dishwasher is designed for operation on an adequately wired individual 120 V, 60 Hz, 15- or 20-amp fused electrical supply with copper wire only. It is recommended that a time-delay fuse or circuit breaker is used, and that a separate circuit serving only this appliance is provided. If an outlet is used, the outlet should be placed in adjacent cabinet.

## LOCATION REQUIREMENTS

- Install where dishwasher is protected from the elements. Protect against freezing to avoid possible rupture of fill valve. Such ruptures are not covered by the warranty. For winter storage information, see “Storing” in the “Dishwasher Care” section.
- Install and level dishwasher on a floor that will hold the weight and in an area suitable for its size and use.

## WATER SUPPLY REQUIREMENTS

- The water supply temperature should be 120°F to 150°F (49°C to 66°C).
- The water supply must maintain water pressure between 20 and 80 psi for sufficient flow.



# PARTS AND FEATURES

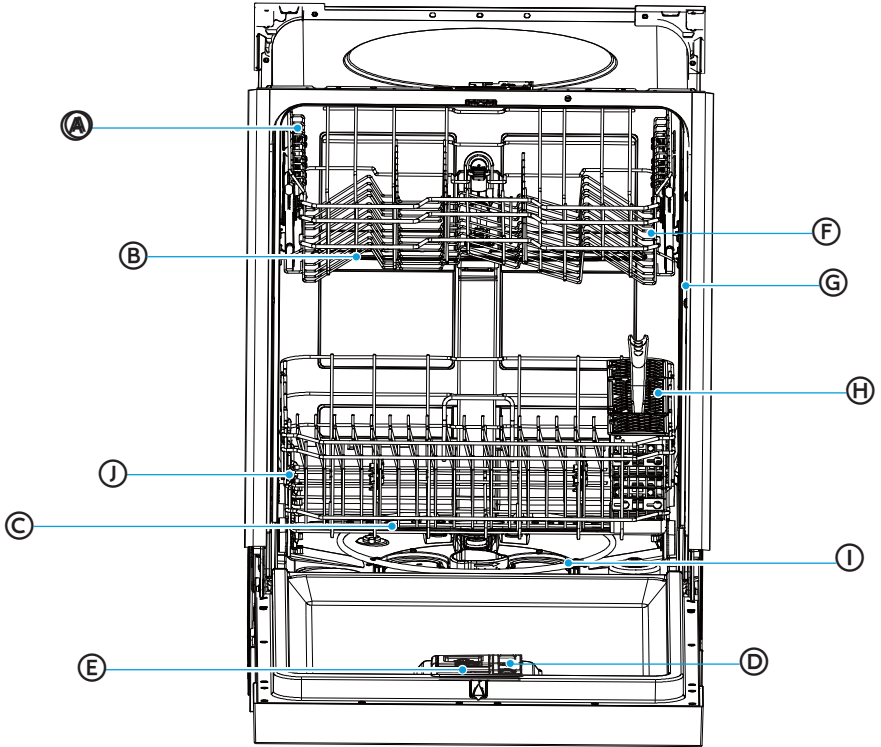

- |                         |                       |
|-------------------------|-----------------------|
| (A) Cup Shelf           | (F) Upper Rack        |
| (B) Middle Spray Arm    | (G) Tub Gasket        |
| (C) Lower Spray Arm     | (H) Silverware Basket |
| (D) Rinse Aid Dispenser | (I) Lower Rack        |
| (E) Detergent Dispenser | (J) Heating Element   |

## SPECIFICATIONS

Capacity:	12 Place Settings
Dimensions (WxDxH):	23 5/8"*22 11/16"*33 11/16" (600x576x855mm)
Weight Unpacked:	81.35 lb (36.9kg)
Power Supply:	120 volts, 60 Hz
Rated Power Usage:	Wash motor 50 W Heater 840 W
Water Feed Pressure:	20-120psi (138-862kPa)~

## FILTER SYSTEM

Your dishwasher has a multiple filter system, which helps your dishwasher perform better using less water and less energy.

The filter system includes three filters that work in combination to separate dirty and clean water into different chambers.



## SMART WASH SYSTEM

Your dishwasher has a Smart Wash system which can be used by selecting the Auto cycle.

The Smart Wash system senses the soil level of the load and adjusts the wash cycle accordingly. Your dishwasher can determine the type of cycle required to clean the dishes and will clean more efficiently every time.

## ADJUSTABLE UPPER RACK

The Adjustable Upper Rack feature allows you to load taller items in either the upper or lower rack.

The upper rack of your dishwasher can be adjusted 2" (5.08 cm). Adjusting the clearance of the Upper Rack increases or decreases the clearance of the lower rack, as shown.

For instructions, see the "Adjustable Upper Rack" section.

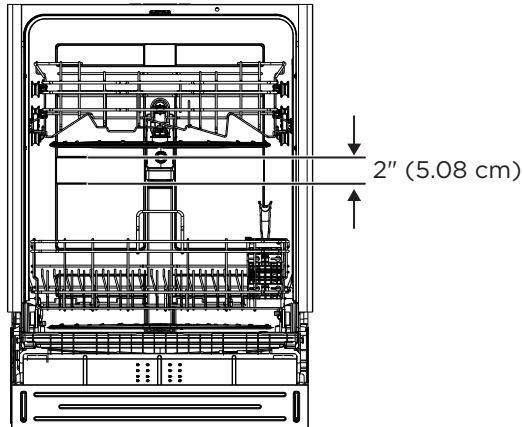

# START UP GUIDE

## IMPORTANT:

- Properly dispose of/recycle all packing material.
- Read this entire User Manual. You will find important safety information and useful operating tips.

## HOW YOUR DISHWASHER CLEANS

Your dishwasher cleans by spraying a mixture of hot water and detergent through the spray arms against soiled surfaces.

The dishwasher fills with water covering the filter area. Water is then pumped through the multiple filters and spray arms. Soil particles are separated from the water and go down the drain as the water is pumped out and replaced with clean water.

The number of water fills will vary depending on the cycle selected.

## BEFORE USING YOUR DISHWASHER

1. Check the filters for debris that may have been introduced from the packaging or during installation. See the “Clean Filters” section.
2. Add Rinse Aid. See “Proper Use of Rinse Aid.”

## USING YOUR NEW DISHWASHER

**NOTE:** To decrease cycle time and possibly improve performance, turn on the hot water faucet nearest to the dishwasher until the water runs hot. Turn off the water.

1. Load dishwasher. See “Dishwasher Loading.”
2. Add detergent. See “Proper Use of Detergent.”
3. Select desired CYCLE and OPTIONS. See “Cycle and Option Charts.”
  - Only the Options available for the Cycle selected will illuminate.
  - The controls of the selected Cycle and Options will glow to indicate they are selected.
4. Close the door firmly to latch.
5. Press START.

# CONTROLS



## NOTE:

when the door is closed.

### Ⓐ Power

Press this button to turn on or turn off the dishwasher

### Ⓑ Cycle

Press this button to select corresponding washing program code.

Auto, Hvy, Norm, Glass, ECO, Quick, Rinse can be selected.

#### **Auto**

Auto cycle uses sensors in the dishwasher to determine the soil level of the dish load, and then adjusts the wash cycle to optimize wash performance, water and energy usage.

#### **Hvy-Heavy**

Heavy cycle is for pots, pans, casseroles and dinnerware with dried-on or baked on soil.

#### **Nor-Normal**

Normal cycle with only the Heat Dry option selected is recommended to completely wash and dry a full load of normally soiled dishes. The energy usage label is based on this cycle and option combination with the upper rack in the raised position.

#### **Glass**

Delicate cycle is for items that need special care such as stemware or porcelain.

#### **ECO**

For light soiled or pre-rinsed dishes and silverware.

#### **Quick**

Quick cycle is for lightly soiled or well-rinsed dish loads.

#### **Rinse**

Use for pre-rinsing dishes or glasses. This is only a rinse that keeps food from drying on your dishes and reduces odor buildup in your dishwasher until you are ready to wash a full load.

## © ADDITIONAL FEATURES

### Delay

The Delay Time feature allows you to program the dishwasher to begin the selected wash cycle 1 to 24 hours later.

Press the DELAY control repeatedly to toggle between H01 to H24 in the screen. The LED next to the selected time will illuminate.

**NOTE:** To cancel the Delay feature, press and hold the START control for 3 seconds to Cancel. To begin the wash cycle immediately, press START again.

### Lock

Use to lock all controls and prevent children from accidentally changing the dishwasher cycle or starting the dishwasher.

- Press and hold for 3 seconds Heated Dry and Options to either activate or cancel the Child Lock option. After the function is selected the lock icon will illuminate. If the the function is canceled, the lock icon will light off.

## ⓓ FUNCTION

Functions enhance the wash cycle. Some functions are available with only certain Wash Cycles. Refer to the “Cycle and Options Charts” to see which functions are available for the wash cycle you selected.

- Press the desired function control(s). The function control(s) illuminates to indicate which function(s) have been selected.

### Heated Dry

When the Heated Dry option is selected, the heater will work during the drying process.

### Sanitize

**WARNING:** Only sanitizing cycles have been designed to meet the requirements for soil removal and sanitization efficacy. There is no intention, either directly or indirectly, that all cycles on a certified machine have passed the sanitization performance test.

The Sanitize Cycle is NSF certified the sanitize option sanitizes dishes and glassware in accordance with NSF International NSF/ANSI Standard 184 for Residential Dishwashers. Certified residential dishwashers are not intended for use in licensed food establishments.

When the Sanitize option is selected, the water temperature will reach 156.2°F (69°C) maximum.

The Sanitize Control illuminates to indicate when the Wash cycle with the Sanitize option is completed. The light will turn off after the door has been opened for 30 seconds.

**NOTE:** It is possible that the water will not reach 156°F (69°C) in the Sanitize mode, if the temperature of the incoming hot water does not meet the minimum requirement of 120°F (49°C).

### **Half Load**

When you have about or less than half of full place settings dishware to wash, you can choose this function to save energy and water.

## **Ⓔ INDICATOR LIGHTS**

### **Rinse Aid**

The Rinse Aid indicator light illuminates when the rinse aid level is low. Rinse Aid should be added to the Rinse Aid dispenser.

### **Sanitized**

The Sanitized indicator light illuminates when the cycle using the Sanitize option is finished.

The light turns off when the door is opened and then closed or any button is pressed.

## **Ⓕ START**

**Start** - Close the door and press Start. The cycle will begin.

**PAUSE** - If you need to pause or cancel a dishwasher cycle in process:

**IMPORTANT:** Open the door slightly, and then wait for the spray arms and wash action to stop before opening the door completely. Doing this will help keep you from being splashed with hot water.

1. Open the door slightly and wait a few seconds until the wash action stops.
2. Open the door to add or remove items.
3. Close the door and then Press START to resume the wash cycle.

**CANCEL** - To cancel a cycle when the dishwasher is running, press and hold Start for 3 seconds.

## CYCLE AND OPTION CHARTS

Depending on the Cycle selected, the Options available for selection will illuminate.

Cycle times are approximate and will vary depending on the wash cycle and options selected.

**NOTE:** Added Options can add more time and use more water.

Hot Water is necessary to activate the dishwasher detergent and melt fatty food residue.

An automatic sensor checks the temperature of the incoming water. If the water is not hot enough, the cycle will be lengthened to heat the water for the main wash.

The Smart Wash Sensor detects the soil level of the dish load and may increase or decrease cycle time depending on the number of water fills required to clean the load.

Cycle	Options Available	Water Usage	Cycle Time
<b>Auto</b>	Heated Dry Sanitize Half Load	3.04-7.0gal 11.5-26.5L	109-149mins
<b>Heavy</b>	Heated Dry Sanitize Half Load	7.13 gal. 27 L	151 mins.
<b>Normal</b>	Heated Dry Sanitize Half Load	3.04-7.04gal. 11.5-26.6 L	108-146 mins.
<b>Glass</b>	Heated Dry Sanitize Half Load	7.01 gal. 26.5L	118 mins.
<b>ECO</b>	Heated Dry Sanitize Half Load	5.97gal. 22.6L	149mins.
<b>Quick</b>	Heated Dry Sanitize	4.11 gal. 15.5 L	60 mins.
<b>Rinse</b>	N/A	2.0 gal. 7.6 L	20 mins.



# DISHWASHER LOADING

## PREPARE DISHES

- Empty liquids from glasses and cups.
- Remove leftover food, bones, toothpicks and other hard items from the dishes and discard.
- It is not necessary to hand-rinse dishes before loading them into the dishwasher with the following exceptions:
  - Foods such as mayonnaise, mustard, vinegar, lemon juice and tomato-based products may discolor stainless steel and plastics if allowed to remain on them for any length of time.
  - Burned-on foods should be loosened before loading the cookware into the dishwasher.

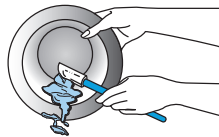

## LOAD DISHES

- It is **IMPORTANT** for the water spray to reach all soiled surfaces.
- Load dishes so they are not stacked or overlapping if possible. For best drying results, water must be able to drain from all surfaces.
- Load heavy pots and pans carefully. Heavy items can dent the stainless steel interior of the door if they are dropped or bumped.
- Make sure pot lids and handles, pizza pans, cookie sheets, etc., do not interfere with the spray arm rotation.
- Make sure both the upper and lower spray arms are not blocked and move freely.

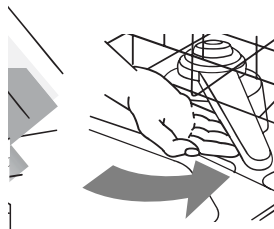

## QUIET OPERATING TIPS

### To avoid thumping/clattering noises during operation:

- Make sure lightweight items are secured in the racks.
- Make sure pot lids and handles, pizza pans, cookie sheets, etc., do not touch interior walls or interfere with the rotation of the spray arm.
- Load dishes so they do not touch one another.

**NOTE:** For built-in models, keep sink drain plugs closed during dishwasher operation to prevent noise transfer through drains.

## UPPER RACK

The upper dishwasher rack is designed for cups, glasses, small plates, bowls and plastic items marked dishwasher safe.

The upper rack can be easily adjusted 2" (5 cm) up or down to accommodate taller items in either in the top or bottom rack.

### ADJUST UPPER RACK

#### IMPORTANT:

- Remove all items before adjusting the rack. The rack must be empty.

To adjust the height of the upper rack, follow these steps:

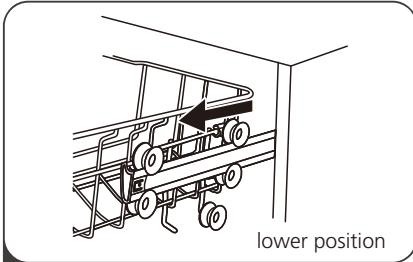

1 Pull out the upper basket.

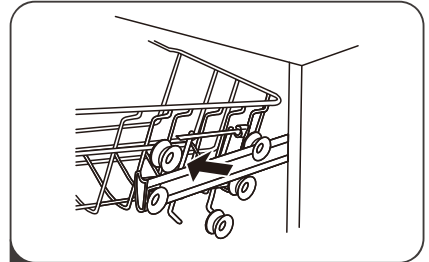

2 Remove the upper basket.

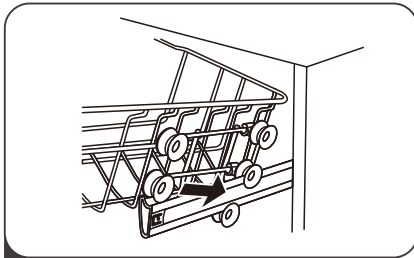

3 Re-attach the upper basket to upper or lower rollers.

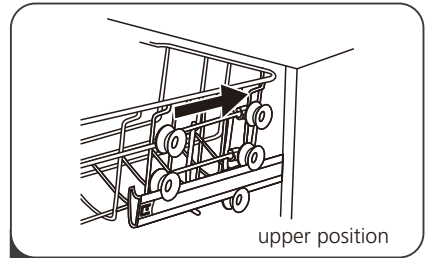

4 Push in the upper basket.

# LOAD UPPER RACK

**NOTE:** The features on your dishwasher rack may vary from the drawings shown.



8 Place Setting

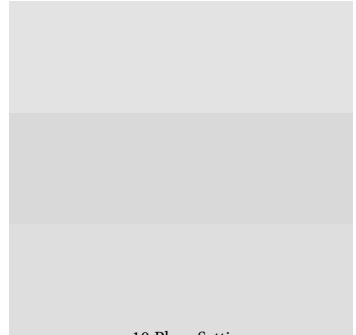

10 Place Setting

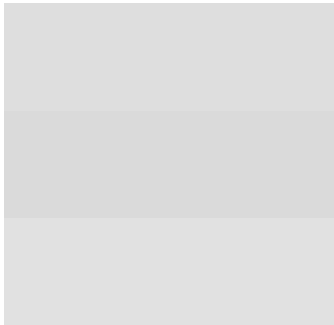

12 Place Setting

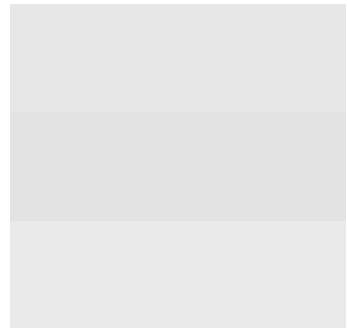

8 Place Setting(DOE)

**IMPORTANT:** Make sure the items loaded in the upper rack do not interfere with the rotation of the middle spray arm located beneath the upper rack. Check for interference by turning spray arm by hand.

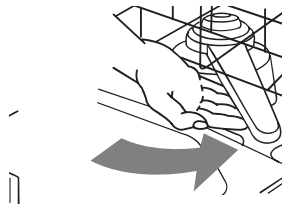

- Place items so that the open ends face downward for cleaning and draining.
- Load glasses and cups in upper rack only. The lower rack is not designed for glasses and cups. Damage can occur.
- Place cups and glasses in the rows between tines. Placing them over the tines can lead to breakage, water spots, and poor cleaning.
- Small bowls, pans and other utensils can be placed in the top rack. Load bowls in the center section for best stability.
- China, crystal and other delicate items must not touch each other during dishwasher operation. Damage may occur.
- Load plastic items so the force of the spray does not move them during the cycle.

# LOWER RACK

The lower rack is designed for plates, soup bowls, cookware and bakeware.

The adjustable upper rack allows you to load items up to 12.6" in height in the lower rack.

**IMPORTANT:** Items in the lower rack must be placed so that they do not interfere with the rotation of the spray arms, block the water inlet, or keep the water spray from reaching the detergent dispenser.



8 Place Setting

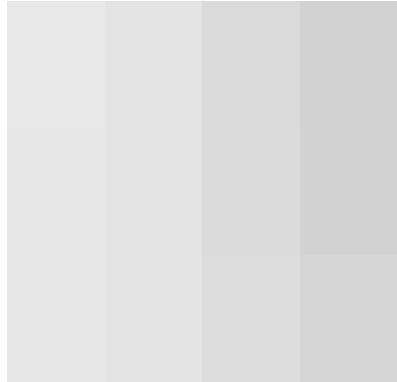

10 Place Setting

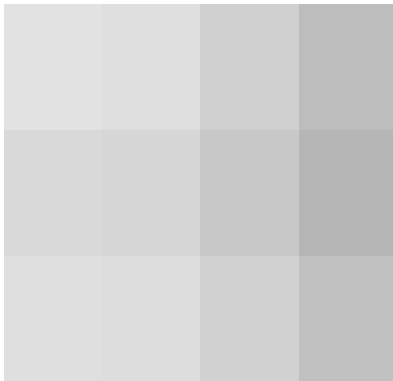

12 Place Setting

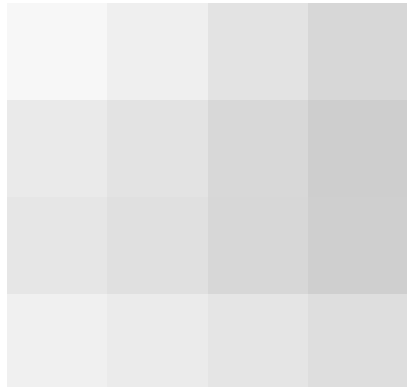

8 Place Setting(DOE)

## LOAD LOWER RACK

**NOTE:** The features on your dishwasher rack may vary from the drawings shown.

- Do not load glasses, cups, or plastic items in the lower rack.
- Load small items in the lower rack only if they are secured in place.
- Load plates, soup bowls, etc. between tines. Do not nest bowls because the spray will not reach all surfaces.
- Do not load items between the bottom rack and the side of the dishwasher tub.
- Place heavily soiled cookware face down in the rack.

## ADJUSTABLE RACK TINES

The fold-down tines in the lower rack make it easier to load extra large or hard-to-fit items such as serving bowls and roasters. The tines may be left in the up position for normal use, or folded down for more flexible loading.

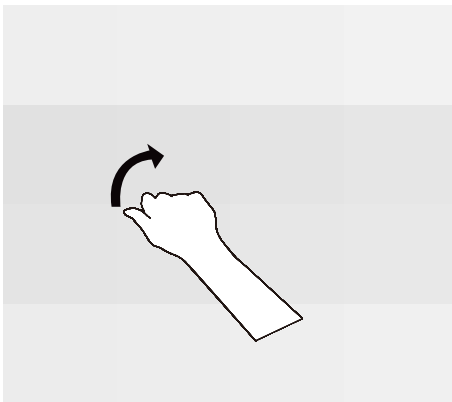

# LOADING SILVERWARE

## NOTES:

- Do not load silver or silver-plated silverware with stainless steel. These metals can be damaged by contact with each other during washing.
- Some foods (such as salt, vinegar, milk products, fruit juices, etc.), can pit or corrode silverware. DO NOT WASH ALUMINUM COOKWARE IN YOUR DISHWASHER.

## THREE-PIECE SILVERWARE BASKET

The silverware basket consists of three separate sections. For optimum loading flexibility, the center section of the basket can be used individually, joined with one or both side sections or removed.

- Lift handle to remove the silverware basket and set the basket on a counter or table top.
- Lift up on each side section to disengage the center section from the keyhole slots in the side sections.
- Either replace the section(s) in the bottom rack and load the silverware, OR load the silverware while the section(s) are on the countertop and then replace the basket in the bottom rack.

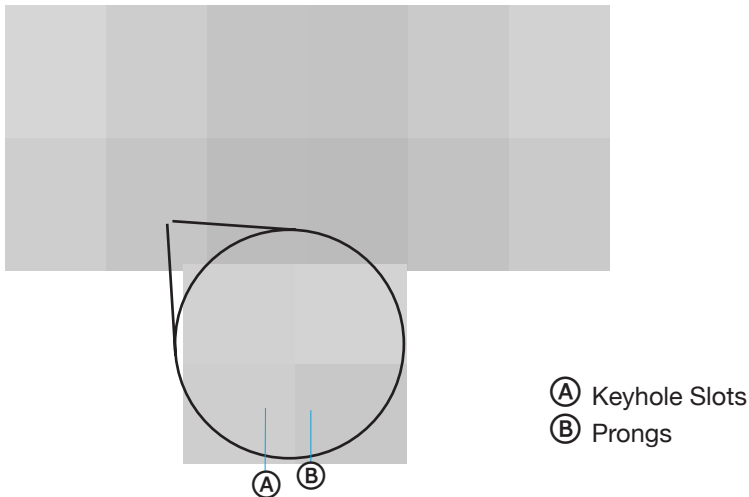

**For Best Results:**

- Load items with handles down, using the separators to prevent silverware from nesting.
- Place small items such as baby bottle caps, jar lids, corncob holders, etc. in the section(s) with hinged cover(s). Close the cover to hold small items in place.
- Unload or remove the basket before unloading the racks to avoid water drops from falling on the silverware.
- When handles are up, mix items in each section of the basket with some pointing up and some down to avoid nesting. Spray cannot reach nested items.

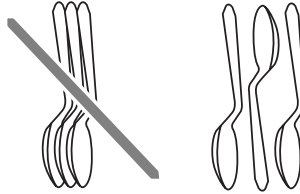

**IMPORTANT:** Always load sharp items (knives, skewers, etc.) pointing down. Be sure that nothing protrudes through bottom of the basket or rack that may block the wash arm.



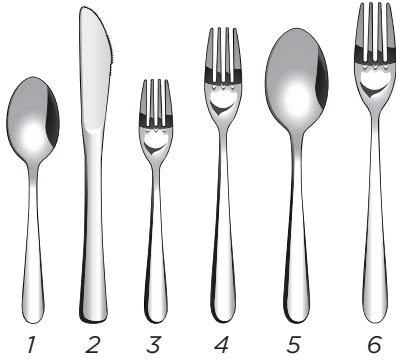

1. Spoons
2. Knives
3. Salad Forks
4. Forks
5. Large Spoons
6. Large Forks

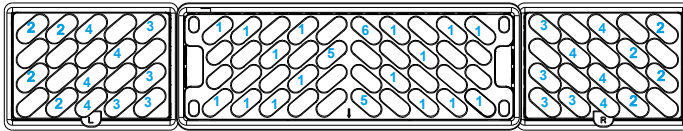

8 Place Setting

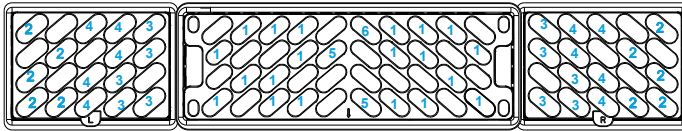

10 Place Setting

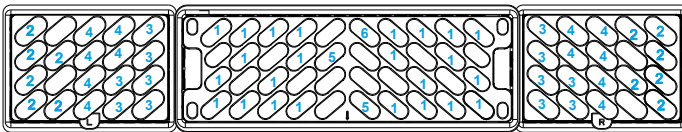

12 Place Setting

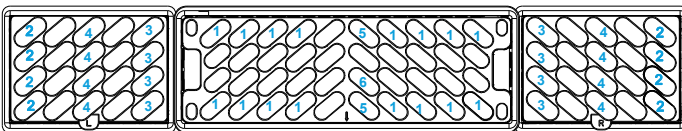

8 Place Setting(DOE)



# DISHWASHER USE

## PROPER USE OF DETERGENT

### IMPORTANT:

- Use automatic dish washing detergent only. Other detergents can produce excessive suds that can overflow out of the dishwasher and reduce washing performance.
- Add detergent just before starting a cycle.
- Store detergent tightly closed in a cool, dry place. Fresh automatic dishwasher detergent results in better cleaning.

## DETERGENT DISPENSER

1. Push the dispenser cover release catch to open the main wash detergent compartment.

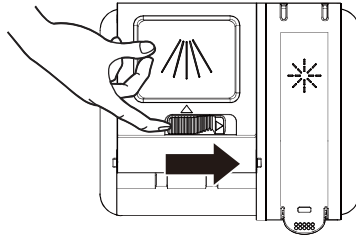

### NOTE:

The flap is always open at the end of a dishwashing cycle.

2. Add the recommended amount of detergent to the detergent compartment.

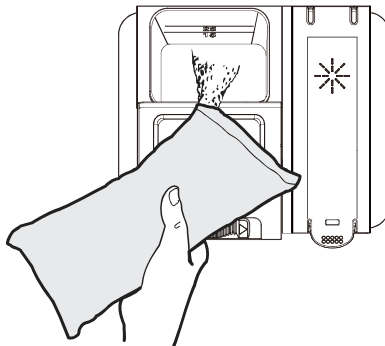

3. Press down on the top of the cover to secure.

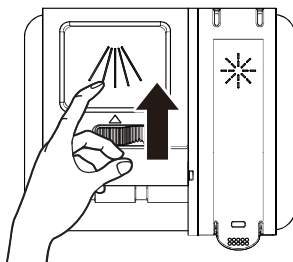

## HOW MUCH DETERGENT TO USE

The amount of detergent to use depends on the soil level of your load, the type of detergent used and the hardness of your water.

- If you use too little detergent, dishes won't be clean.
- If you have soft water and use too much detergent, glassware will etch.

## Water Hardness

Water hardness varies depending on your water source. For the best results, your dishwasher is designed to operate with water that has a hardness of no more than 7 grains per gallon. Test kits are available from all major appliance parts retail outlets. If your water has a hardness over 8 grains per gallon, you may consider installing a water softener or regularly use an additive to enhance the performance of your detergent.

## PROPER USE OF RINSE AID

Rinse aid prevents water from forming droplets that can dry as spots or streaks. A small amount of the rinse aid is released into the final rinse water, which allows water to drain from the dishes.

Rinse aid greatly improves drying performance after the final rinse .

Your dishwasher is designed to use a LIQUID rinse aid. Do not use a solid or bar-type rinse aid.

## RINSE AID DISPENSER

Under normal conditions, you will need to fill the rinse aid dispenser approximately once a month. Rinse aid is released through an opening in the dispenser. You do not need to wait until the dispenser is empty to refill it. Try to keep it full, but be careful not to overfill it

## To refill the rinse aid dispenser

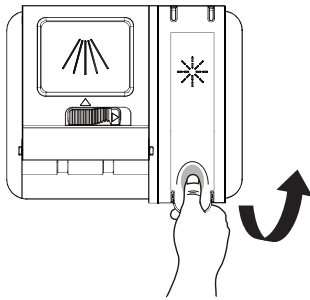

1. Lift up the end tab of rinse aid cover to open.

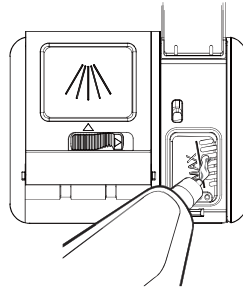

2. Fill the rinse aid dispenser with liquid rinse aid until full. DO NOT overfill.

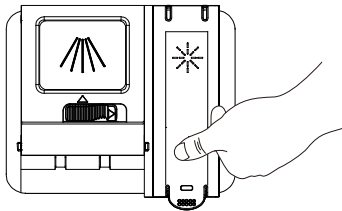

3. Press the rinse aid cover down firmly to close.

### NOTE:

Use the viewing port when filling the rinse aid reservoir.

## WARNING

Do not fill the reservoir above the full level indicator. Excess rinse aid can overflow during the wash cycle.

## To adjust the rinse aid setting

You can adjust the amount of the rinse aid released during the rinse aid according to the following steps:

1. Close the door and power on the dishwasher
2. Within 60 seconds after step 1, press the CYCLES button more than seconds to enter into the setting mode, the rinse aid indicator will blink quickly.
3. Press the CYCLES button to select the proper setting according your using habits. The setting will change in the following sequence: d3->d4->d5->d1->d2->d3.
4. Without any operation in 5 seconds or press the Power button to complete the setting and exit the setting mode.

## WASHING SPECIAL ITEMS

If you have doubts about washing a particular item, check with the dishware manufacturer to make sure it is dishwasher safe.

Material	Dishwasher Safe	Comments
Aluminum	Possible	High water temperature and detergents can affect finish of anodized aluminum. Unfinished aluminum will be discolored.
Disposable Aluminum	No	Do not wash disposable aluminum pans in the dishwasher. These might shift during washing and transfer black marks to dishes and other items.
Bottles and cans	No	Wash bottles and cans by hand. Labels attached with glue can loosen and clog the spray arms or pump and reduce washing performance.
Cast Iron	No	Seasoning will be removed and iron will rust.
China / Stoneware	Yes	Always check manufacturer's recommendations before washing. Antique, hand-painted, or over-the-glaze patterns may fade, gold leaf can discolor or fade.
Crystal	Yes	Check manufacturer's recommendations before washing. Some types of leaded crystal can etch with repeated washing.
Gold	No	Gold-colored flatware will discolor.
Glass	Yes	Milk glass yellows with repeated dishwasher washing.
Hollow-Handle Knives	No	Handles of some knives are attached to the blade with adhesive that can loosen if washed in the dishwasher.
Pewter Brass, Bronze	No	High water temperatures and detergent can discolor or pit the finish.
Disposable Plastics	No	Cannot withstand high water temperatures and detergents.
Plastics	Yes	Always check manufacturer's recommendations before washing. Plastics vary in their capacity to withstand high temperatures and detergents. Load plastics in top rack only.
Stainless Steel	Yes	Run a rinse cycle if not washing immediately. Prolonged contact with food containing salt, vinegar, milk products, or fruit juice can damage finish.

Material	Dishwasher Safe	Comments
Sterling Silver or Silver Plate	Yes	Run a rinse cycle if not washing immediately. Prolonged contact with food containing salt, acid, or sulfide (eggs, mayonnaise, and seafood) can damage finish
Tin	No	Can rust.
Wooden Ware	No	Wash by hand. Always check manufacturer's instructions before washing. Untreated wood can warp, crack, or lose its finish

## DISHWASHER CARE

### CLEANING

#### CLEANING THE EXTERIOR

In most cases, regular use of a soft, damp cloth or sponge and a mild detergent is all that is necessary to clean outside of your dishwasher.

Clean the stainless steel door and handle regularly with a clean, soft cloth to remove debris.

**IMPORTANT:** Do not use appliance wax, polish, bleach, or products containing chlorine to clean the stainless steel door.

#### Control Panel

Gently clean the control panel with a clean, soft cloth.

#### CLEANING THE INTERIOR

The tub is made of stainless steel designed to resist rust and corrosion if the dishwasher is scratched or dented.

Hard water minerals can cause a white film to build up on the inside surfaces, especially just beneath the door area.

Do not clean the dishwasher interior until it has cooled. Wear rubber gloves. Do not use any type of cleanser other than dishwasher detergent because it may cause foaming or create suds.

#### DOOR GASKET

Clean the steel inner door and tub with a clean, soft damp cloth.

Using a damp cloth, clean around the door gasket regularly to remove food particles.

## CONTROL PANEL

Clean the Control Panel gently with a lightly dampened cloth.

## CLEANING THE FILTERS

Check and clean the filters regularly for best performance.

1. Remove the lower dishwasher rack.
2. Rotate the Cylinder filter counterclockwise a quarter turn and lift up to remove.

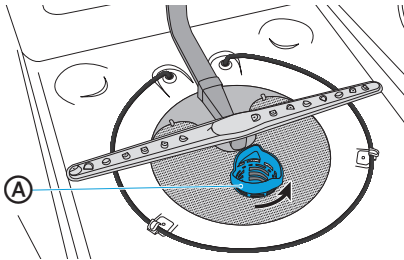

(A) Cylinder Filter

3. Empty the Cylinder filter and rinse it under running water.
4. Remove the Fine filter.

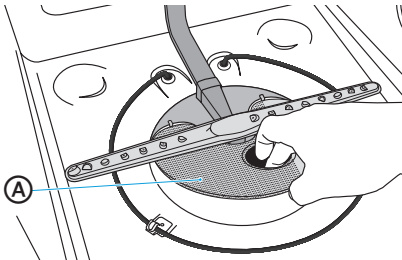

(A) Fine Filter

5. Remove the Micro filter from the bottom of the tub.

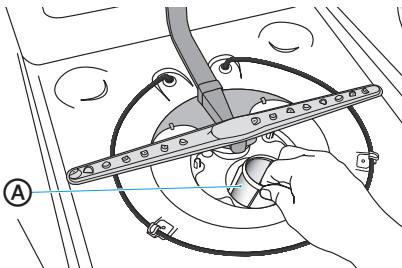

(A) Micro Filter

6. Inspect both the Fine filter and the Micro filter for debris, and then clean them by holding the filters under slow running water.

**NOTE:** A stiff, plastic bristle brush may be needed to remove some debris.

7. Reinstall the filters in reverse order making sure the Cylinder filter locks into place.

## DRAIN AIR GAP

Check the drain air gap anytime your dishwasher isn't draining well. Some state or local plumbing codes require the addition of a drain air gap between a built-in dishwasher and the home drain system. If a drain is clogged, a drain air gap prevents water from backing up into the dishwasher.

The drain air gap is usually located on top of the sink or countertop near the dishwasher.

**NOTE:** The drain air gap is an external plumbing device that is not part of your dishwasher. The warranty provided with your dishwasher does not cover service costs directly associated with the cleaning or repair of the external drain air gap.

### To Clean the Drain Air Gap:

Clean the drain air gap periodically to ensure proper drainage of your dishwasher. Follow the cleaning instructions provided by the manufacturer.

#### With most types:

1. Turn off the dishwasher.
2. Lift off the metal cover, and then unscrew the plastic cap.
3. Clean the plastic cap with a toothpick.

## STORING

### STORING FOR THE SUMMER

Protect your dishwasher during the summer months by turning off the water supply and power supply to the dishwasher.

### WINTERIZING YOUR DISHWASHER

Protect your dishwasher and home against water damage caused by freezing water lines. If your dishwasher is left in a seasonal dwelling or could be exposed to near freezing temperatures, have your dishwasher winterized by authorized service personnel.

#### Prepare for Storage:

1. Turn off electrical power to the dishwasher.
2. Turn off the water supply.
3. Place a pan under the inlet valve, and then disconnect the water line from the inlet valve.
4. Disconnect the drain line from the pump and drain water into the pan.

**Prepare for Use:**

1. Reconnect the water, drain and electrical power supply.
2. Turn on water and electrical power supply.
3. Fill detergent cup and run the dishwasher through a heated wash cycle.
4. Check the connections for leaks.

## TROUBLESHOOTING

### DISHWASHER NOT OPERATING PROPERLY

PROBLEM	POSSIBLE CAUSE	SOLUTION
<b>Dishwasher does not run or stops during a cycle</b>	There is no power to the dishwasher.	Replace fuse or reset circuit breaker.
	The door is not closed tightly and latched.	Close and latch the door.
	Most cycles pause for 5 minutes near the start of a cycle to let the dishes soak.	This is normal, and reduces the energy required to clean the dishes.
	Certain cycles repeatedly pause for 15 to 65 seconds during the main wash.	This is normal.
<b>Dishwasher does not start a cycle</b>	The Delay feature is selected.	To reset, see “Options” in the Controls section.
	Control Lock feature is activated.	Deactivate Control Lock. See “Additional Features” in the Controls section.
<b>Dishwasher will not fill</b>	The water shutoff valve is not turned on.	Turn on the water valve.
	The door is not closed tightly and latched.	Close and latch the door.
	Water pressure is too low.	Verify a minimum of 20 psi water pressure is maintained during the filling operation.



PROBLEM	POSSIBLE CAUSE	SOLUTION
<p><b>Dishwasher seems to run too long</b></p>	<p>The water supplied to the dishwasher is not hot enough.</p> <p>The dishwasher runs longer while heating water, and a delay automatically occurs in some wash and rinse cycles until the water reaches the proper temperature.</p> <p>The Sanitize option is selected.</p> <p>The cycle time will vary depending on soil level.</p> <p>Dishwasher is connected to the Cold water supply.</p>	<p>Run the water in the adjacent sink until it gets hot before turning on the dishwasher.</p> <p>The cycle time increases to heat the water to the correct temperature for sanitizing.</p> <p>When heavy soil is detected, the Normal cycle will automatically increase the cycle time.</p> <p>Verify the dishwasher is connected correctly to the Hot water supply.</p>
<p><b>Water remains in the dishwasher</b></p> <p><b>NOTE:</b> A small amount of clean water around the outlet in the bottom of the tub is normal. It keeps the seal lubricated.</p>	<p>The cycle is not complete or it is in a pause.</p> <p>The drain hose is kinked.</p> <p>The knockout plug is still in the garbage disposal.</p> <p>Drain hose is connected to the garbage disposal, and the garbage disposal is not empty.</p> <p>Drain is clogged.</p>	<p>The water will drain when the cycle is completed.</p> <p>Straighten the drain hose.</p> <p>Remove the knockout plug.</p> <p>Run the garbage disposal until it is empty.</p> <p>Check the air gap.</p>
<p><b>Detergent remains in the dispenser</b></p>	<p>The cycle has not completed.</p> <p>The detergent is damp or has clumped.</p> <p>An item was blocking the dispenser.</p> <p>The spray arm is blocked.</p>	<p>Close the door and press START to complete cycle.</p> <p>Remove detergent and replace with fresh dry dishwasher detergent.</p> <p>Remove item. Remove detergent and replace with fresh dry dishwasher detergent.</p> <p>Load the dishes in a manner that does not block the spray arm from rotating freely.</p>

PROBLEM	POSSIBLE CAUSE	SOLUTION
<b>Grinding, grating, crunching or buzzing sounds</b>	A hard object or powder detergent granules have entered the wash module.	<b>IMPORTANT:</b> Clear glass is hard to see in water, and could result in a cut wound.  Using care, remove the hard object. If the noise was caused by detergent granules, the noise should stop once the detergent is ground up.  <b>NOTE:</b> If the noise persists after a complete cycle, call for service.
<b>Beeps</b>	Indicates the wash cycle is completed.  <b>NOTE:</b> A rapid beep indicates an error condition.	This is normal.  See “Error Codes” for further direction.
<b>Suds in the Tub</b>	Used wrong type of detergent.	Use only detergent approved for automatic dishwashers.
<b>Dishwasher Leaks</b>	Excessive suds caused by using improper detergent.  Dishwasher is not level.	Use only detergent approved for automatic dishwashers.  Level the Dishwasher. See Installation Instructions.
<b>Rinse Aid light is on</b>	The Rinse Aid level is low.	Add liquid Rinse Aid.

## DISHES ARE NOT COMPLETELY CLEAN

PROBLEM	POSSIBLE CAUSE	SOLUTION
<b>Food residue remains on the dishes</b>	Dishwasher is not loaded correctly.	See “Dishwasher Loading.”
	The wrong wash cycle for the dish load was selected.	Select the wash cycle based on the most difficult soil in the dishwasher load. If you have some items with heavier soils, use a heavier washing cycle.
	Water temperature is too low.	For best results, the temperature of the incoming water should be a minimum of 120°F (49°C).
	Used incorrect amount of detergent.	Use a minimum of 1 Tbsp. (15 g) detergent per load. Heavy soil and/or hard water generally requires additional detergent.

PROBLEM	POSSIBLE CAUSE	SOLUTION
<b>Food residue remains on the dishes (cont.)</b>	Detergent is too old.	Detergent must be fresh to be effective. Store detergent in a cool, dry area.
	Detergent is caked in the dispenser.	Do not allow detergent to sit for several hours in a wet dispenser. Clean dispenser and refill with fresh, dry detergent.
	The pump or spray arm is clogged with labels from bottles and cans.	Check pump and spray arm for labels and remove the labels.
	The pressure of the water coming into the home is too low.	Water pressure should be 20 to 80 psi (138 to 552 kPa) for proper dishwasher fill. A booster pump on the water supply can be added if pressure is too low.
	High suds are slowing the wash arm.	Use only detergent recommended for the dishwasher. Do not use soap or laundry detergents.

## SPOTS AND STAINS ON DISHES

PROBLEM	POSSIBLE CAUSE	SOLUTION
<b>Spotting and filming on dishes</b>	Rinse Aid dispenser is empty.	Add a liquid rinse aid to the dispenser.
	Hard water. High mineral content in your water	Use a rinse aid and keep the dispenser filled to help eliminate spotting and filming. Increase setting on Rinse aid dispenser 1 number per cycle until spotting is eliminated.  <b>NOTE:</b> If your water hardness is 13 grains (223 ppm) or above, it is strongly recommended that you install a home water softener.
	Water temperature is too low.	For best results, water should be a minimum 120°F (49°C) as it enters the dishwasher.
	Did not use enough detergent.	Use a minimum of 1 Tbsp. (15 g) of detergent per load. Heavy soil and/or hard water generally require extra detergent.

PROBLEM	POSSIBLE CAUSE	SOLUTION
<b>Spotting and filming on dishes (cont.)</b>	Detergent is too old.	Detergent must be fresh and dry to be effective. Store detergent in a cool, dry area.
	Home water pressure is too low to fill dishwasher properly.	Water pressure to the home should be 20 to 80 psi (138 to 552 kPa) for proper dishwasher fill. A booster pump on the water supply can be added if pressure is too low.
<b>Silica film or etching</b>	Using too much detergent	If you have soft water use less detergent, but do not use less than 1 Tbsp. (15 g) per load.
	The inlet water temperature exceeds 150°F (65°C).	Lower the incoming water temperature.
<b>Black or gray marks on dishes</b>	Aluminum items rubbing dishes during washing. Disposable aluminum items can break down in the dishwasher and cause marking.	Hand wash aluminum items. Remove aluminum markings by using a mild abrasive cleaner.
<b>Orange stains on plastic dishes or dishwasher interior</b>	Large amounts of tomato-based foods on dishes placed in the dishwasher.	Use a stain removal product to remove stains from your dishwasher. Stains will not affect dishwasher performance.

## DISHES DO NOT DRY COMPLETELY

PROBLEM	POSSIBLE CAUSE	SOLUTION
<b>Dishes are not completely dry</b> <b>NOTE:</b> Plastics often need towel drying.	Dishes are not loaded properly to allow water drainage.	Do not overload dishwasher. Place glasses and cups in the rack so that the bottom surface is slanted to allow water to run off.
	Rinse Aid not used or dispenser is empty.	Use a liquid rinse aid to speed drying and keep the dispenser full.
	Used an air dry or energy-saving option.	For dryer dishes, select a Cycle that allows a Heated Dry option.

## DISHES ARE DAMAGED DURING A CYCLE

PROBLEM	POSSIBLE CAUSE	SOLUTION
<p><b>Dishes are chipped</b></p> <p><b>NOTE:</b> Some types of china and glassware might be too delicate for automatic dish washing. Wash by hand.</p>	<p>Dishes not loaded properly.</p> <p>Moving the rack in or out of the dishwasher too quickly.</p>	<p>Load the dishes and glasses so they are stable and will not strike together from washing action.</p> <p>Minimize chipping by moving the rack in and out slowly.</p>

## ERROR CODES

CODE	MEANING	POSSIBLE CAUSE	POSSIBLE SOLUTION
E1	Either the water flow is insufficient, or the water pressure from the incoming line is too high	<ul style="list-style-type: none"> <li>Faucet is not opened</li> <li>Water pressure is too low</li> <li>The drain hose is plugged.</li> <li>Other (parts failure of inlet or drain system).</li> </ul>	<ul style="list-style-type: none"> <li>Make sure that the water is turned on to the dishwasher.</li> <li>Make sure that the water pressure is 20~100 psi.</li> <li>Check the drain hose.</li> <li>Contact Customer Service.</li> </ul>
E2	Tub water level too high	<ul style="list-style-type: none"> <li>The drain hose is plugged.</li> <li>Other (parts failure of inlet or drain system).</li> </ul>	<ul style="list-style-type: none"> <li>Check the drain hose.</li> <li>Contact Customer Service.</li> </ul>
E4	Overflow or Leak sensor activated	<ul style="list-style-type: none"> <li>A leak</li> <li>Too much water in the tub</li> </ul>	Turn off water to the dishwasher, then check the filter system for blockage. Unblock if necessary. If there is no water in the tub, contact Customer Service
Ed	Communication exception or issue	The display board can't receive or the main board can't send a signal for over 20 seconds	Contact Customer Service.

## WARRANTY AND SERVICE

### **Warrant & Service**

This product has been manufactured by Thor International, 4651 E Airport Drive, California 91761  
For Customer Service, please call (877) 288 - 8099

For the most up to date warranty and service policy, please refer to our website [WWW.THORKitchen.COM/WARRANTY-REGISTRATION](http://WWW.THORKitchen.COM/WARRANTY-REGISTRATION)

For in-warranty service requests, please visit our website at [WWW.THORKitchen.COM/SERVICE](http://WWW.THORKitchen.COM/SERVICE)

Please Note: You must provide proof of purchase or installation date for any in warranty service requests.

# WELCOME TO THE CLUB

You chose THOR Kitchen to enhance your culinary journey and we're stoked to have you in the club. Think of it as a secret society of really savvy people, such as yourself, choosing professional power and performance at an affordable price.



Register your product by following the steps below.

## WARRANTY REGISTRATION



01

Scan the QR code or visit  
[thorkitchen.com/warranty](https://thorkitchen.com/warranty)



02

Input your product info  
and select register



03

You're done.  
Let's get cookin'.

### WARRANTY



### NEED PARTS?

