

Alfresco™

ARXE-42 SERVICE AND PARTS MANUAL

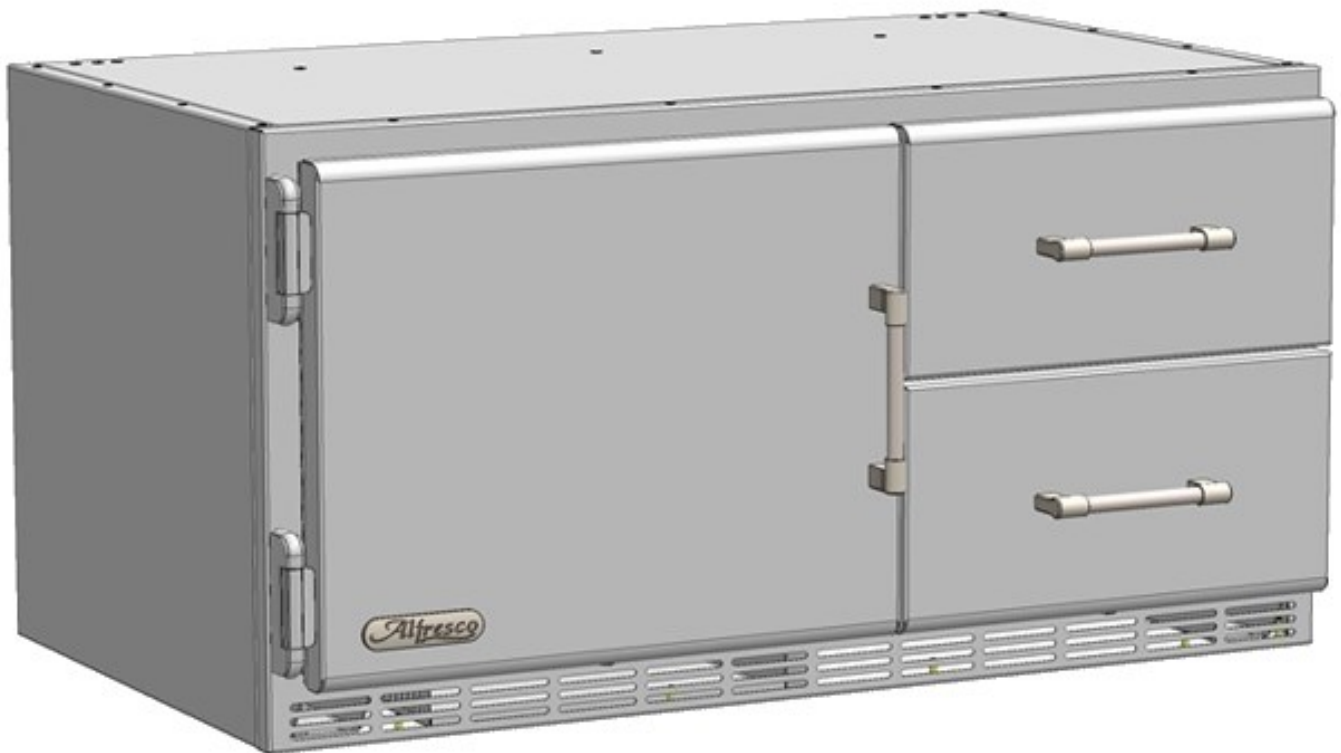

TROUBLESHOOTING AND SERVICE GUIDE

The following is intended as a brief service guide, designed to diagnose most common problems. It is intended to be used only as a guideline. Should the unit require replacement of components, those components must be replaced by a trained and licensed refrigeration professional. While the unit is within the factory warranty period, all repairs require factory authorization before the work is performed.

UNIT NOT COOLING:

- **POWER TO THE UNIT:** Is there power to the unit? Is the voltage within $\pm 10\%$ of 115 VAC? Low power conditions affect the amperage draw of the compressor, therefore requiring more amperes at start up. If the amperage draw is too high, the compressor safety relay could trip, leading to component premature failure. If the compressor is tripping on its safety relay at startups, then the unit will not refrigerate as required.
- **COMPRESSOR NOT RUNNING:** When the unit calls for cooling to begin, power is supplied to the compressor and condenser fan simultaneously, but the power to the compressor is via a time delay set to ten minutes. Therefore, the fan will run for ten minutes before the compressor starts; this is normal.
- **CONDENSER FAN NOT RUNNING:** Is the compressor running but not the condenser fan? If the compressor is running, then the condenser fan should be running. Verify that power is being supplied to the fan motor, and that the fan blades rotate freely. Check for debris (leaves, paper, grass clippings, etc.) in the fan blades, these may prevent the fan from rotating.

UNIT NOT HOLDING TEMPERATURE CORRECTLY:

- **EVAPORATOR INTAKE:** Is the evaporator coil intake blocked by product? The evaporator unit has been designed to prevent products such as bottles, cans or other rigid packaging from blocking the intake. However, products in soft flexible packaging may still be positioned in a way which blocks some, or all of the air intake slots. If the air intake slots are obstructed, then products must be rearranged to clear the slots, thereby permitting air to be drawn into the evaporator coil.
- **DIGITAL TEMPERATURE CONTROL:** Is the control set correctly? Please refer to the recommended settings in the user manual, and follow the instructions for setting the control. If the thermostat is not set to suit the prevailing conditions, then the product may not be refrigerated to your liking. The wrong setting may also cause condensation to form inside the unit, or excessive ice to form in the evaporator coil, thereby blocking air flow through the coil.

NOISY OPERATION:

- **AMBIENT TEMPERATURE:** Is the ambient temperature about 90°F or above? The unit will need to run more at these elevated temperatures, therefore you will become more aware of sound generated by the compressor and the fans.
- **REQUIRED RUN TIME:** Is the unit running continuously for long periods of time? As the ambient temperature rises, the refrigerator requires more cooling, therefore sound from the compressor and fans will become more noticeable.
- **RESIDUAL HEAT:** Is the unit located outdoors on a concrete or paved slab, or in a sunny area? Residual heat present in the concrete or paving will raise the temperature of the intake air entering the front of the unit. Consequently, the air moving through the condenser coil may be relatively hot and therefore less efficient at cooling, causing the unit to run longer in order to maintain the proper refrigerating capacity.
- **DEBRIS IN THE FAN BLADES:** Is there debris in the condenser fan blades? Not only can debris physically stop the fan from rotating (as previously discussed), it can also block or restrict air flow, thus preventing the unit from cooling. The fan blades may, in some cases, continue to rotate, causing a rattling or similar sound as the blades contact debris trapped in close proximity to the fan.
- **FULLY STOCKED:** is the unit fully stocked? If the unit is not fully stocked, or only partially filled, then the unit will need to work harder. Air does not hold temperature, products do. If there is no product inside the refrigerator, the unit will cycle ON and OFF several times per hour. If the unit is fully stocked, the run-time will be extended but also the off-time, allowing the compressor to cool down properly between cycles. This will help the unit to run more efficiently.

PERFORMANCE ENVELOPE:

The ARXE-42 has a performance envelope up to 110°F ambient temperature. This means that the unit is capable of maintaining an internal cabinet temperature of between 22°F and 40°F when exposed to 110°F ambient air temperature. In order to maintain the internal cabinet temperatures stated above, the unit will operate without shutting off when the ambient air temperature exceeds 85 to 90°F. These peak temperatures occur at least for a few hours per day in hot weather locations and should be considered normal. The unit will return to normal cyclic operation after the ambient air temperature falls back below 85 to 90°F. Please note, ambient air temperature is a complex measurement to establish, especially outdoors. Your local weather forecaster, when reporting current conditions, will be referring to a temperature measured in a shaded and ventilated box located at least four feet above the ground. If the reported temperature is 100°F, and your unit is sat on or mounted just above a concrete slab in full sunlight, then the ambient temperature around your unit will be substantially higher than the reported 100°F.

ARXE-42 SERVICE PARTS LIST:

The following is a list of all components and or hardware that are serviceable on the ARXE-42 refrigerator unit. Please refer to the picture and associated text for reference and identification.



Evaporator Fan
210-0025



Condenser Fan
210-0405

Condenser Fan
Mounting Nut
200-0350

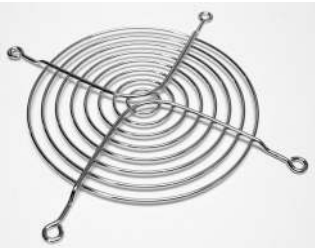

Finger Guard
200-0013



Refrigerator Bulb
210-0327



Main Power Switch
210-0021

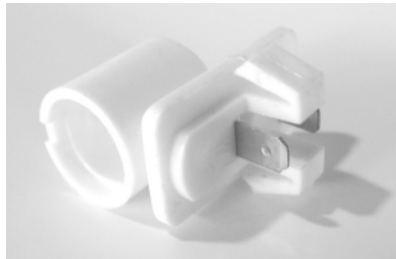

Lampholder
210-0321



Power Cord
210-0287



Compressor
260-0081



Evaporator Fan
Power Cable
210-0020



PTC Relay
260-0090



Filter Drier
220-0029



Overload Protector
260-0091

ARXE-42 SERVICE PARTS LIST CONTINUED:



Condenser Coil
250-0072

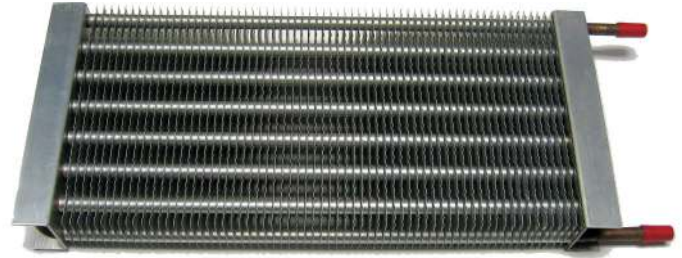

Evaporator Coil
250-0025



Compressor
Protector Cover
260-0087



Strain Relief
200-0009
Used to secure power cord



Run Capacitor
260-0092



Cable Tie
(push mount)
210-0258



Terminal Block
210-0404



Door Hinge
Replacement
Kit
290-0155



Light Switch
210-0308



Fan Motor
210-0401

ARXE-42 SERVICE PARTS LIST CONTINUED:



Food Pan
290-0130



Rear Caster*
290-0079

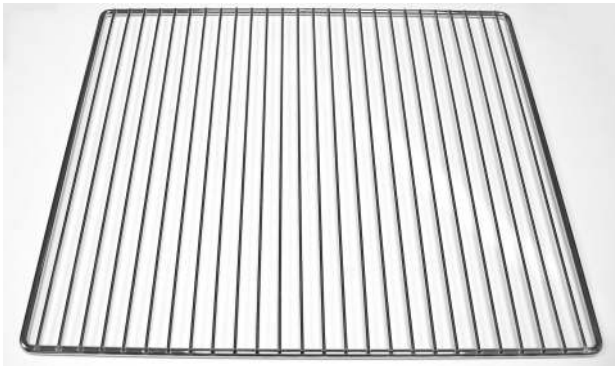

Wire Rack
230-0033



Front Caster*
290-0080



Washer
200-0074



Lock Washer
200-0087



Screw
200-0089

Caster Mounting Hardware
4 each per caster



Refrigeration Controller
210-0425



Drawer Wheel
290-0077



**Drawer Wheel
Screw**
200-0257

* Casters are for BBQ refrigerated base model only.

ARXE-42 SERVICE PARTS LIST CONTINUED:



Drawer Gasket
290-0227

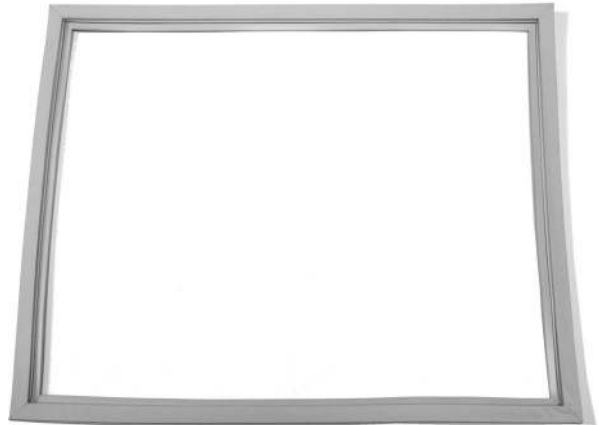

Door Gasket
290-0228

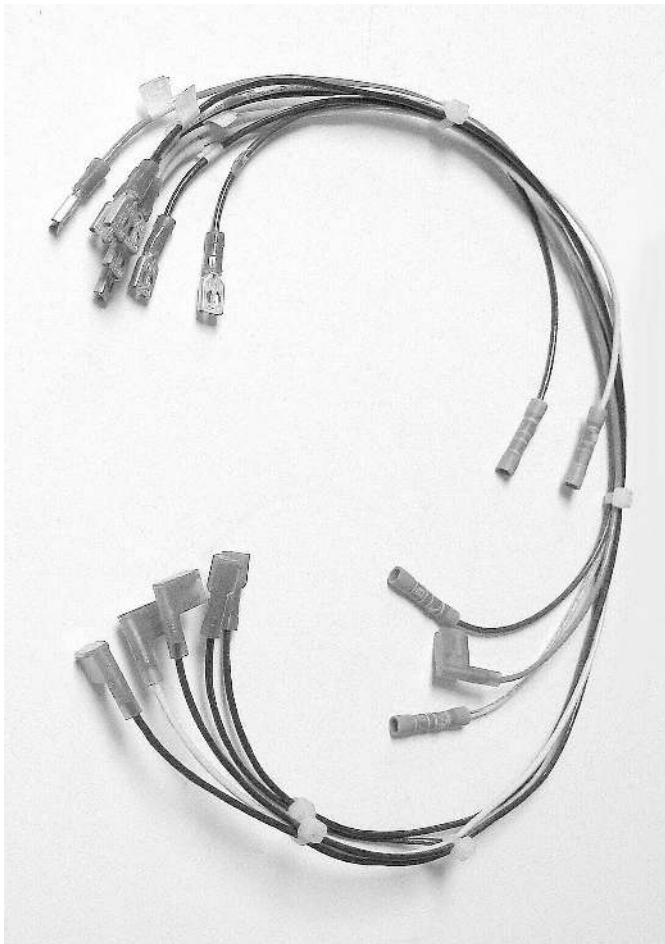

Main Wiring Harness
210-0437

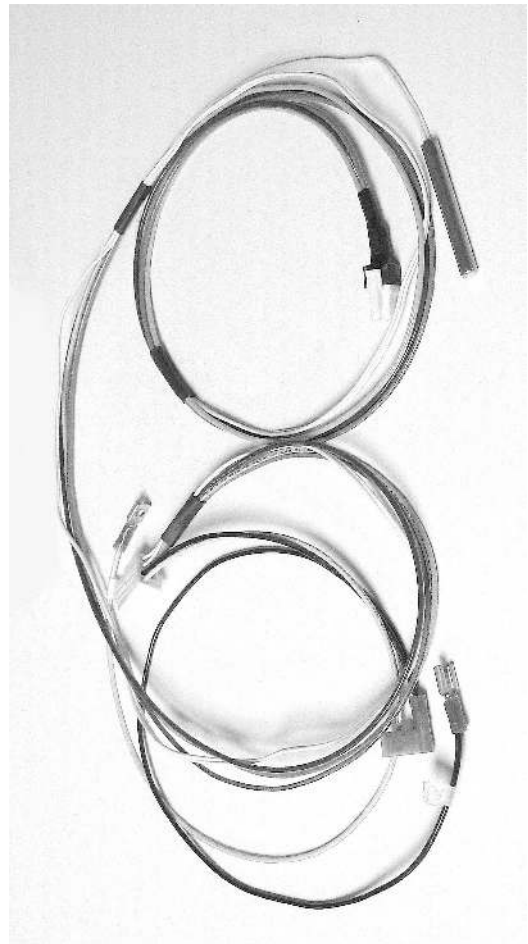

Controller Harness
210-0438

ARXE-42 SERVICE PARTS LIST CONTINUED:

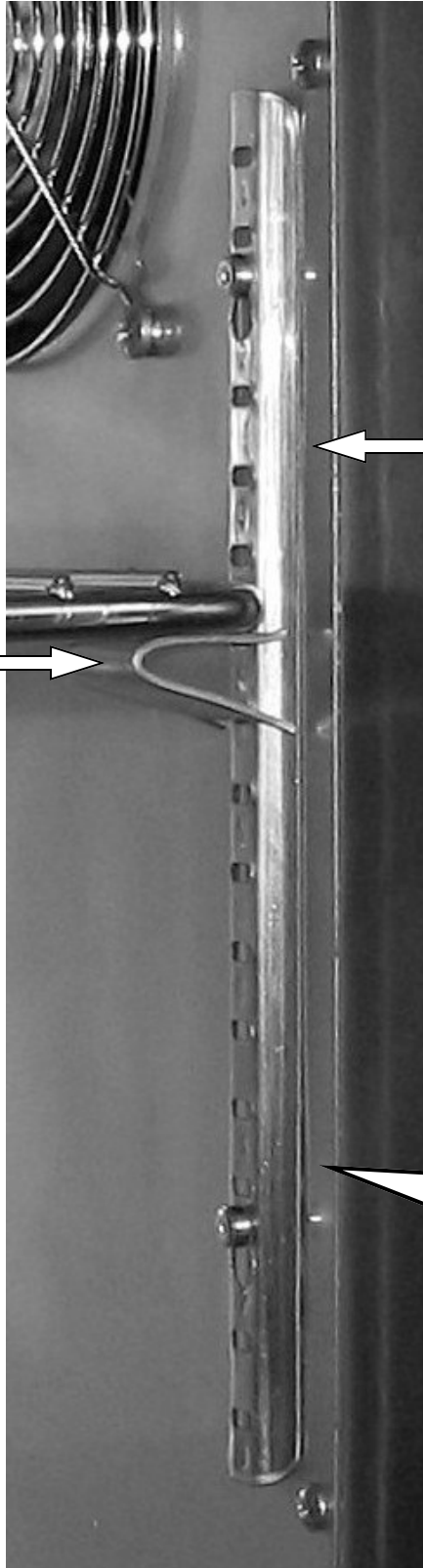

Shelf Clip
290-0140



Pilaster
290-0187



Keyhole Support
290-0141



Pop Rivet
200-0106

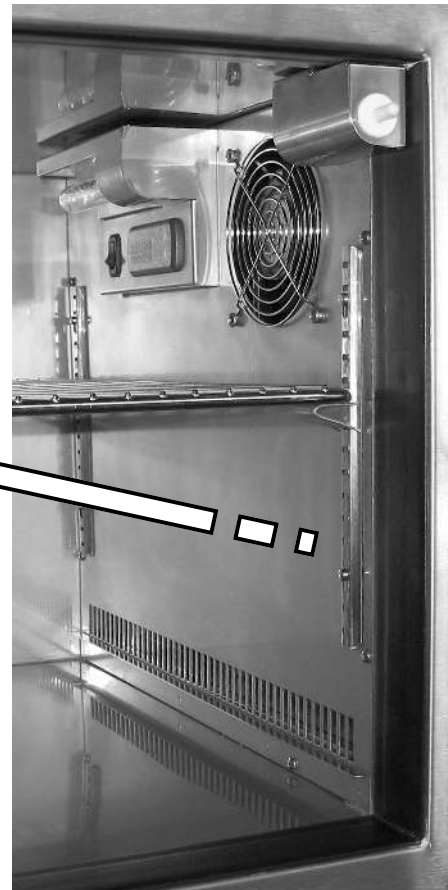

Shelf support pilasters and clips (brackets).
Each unit contains 4 pilasters and 4 clips.

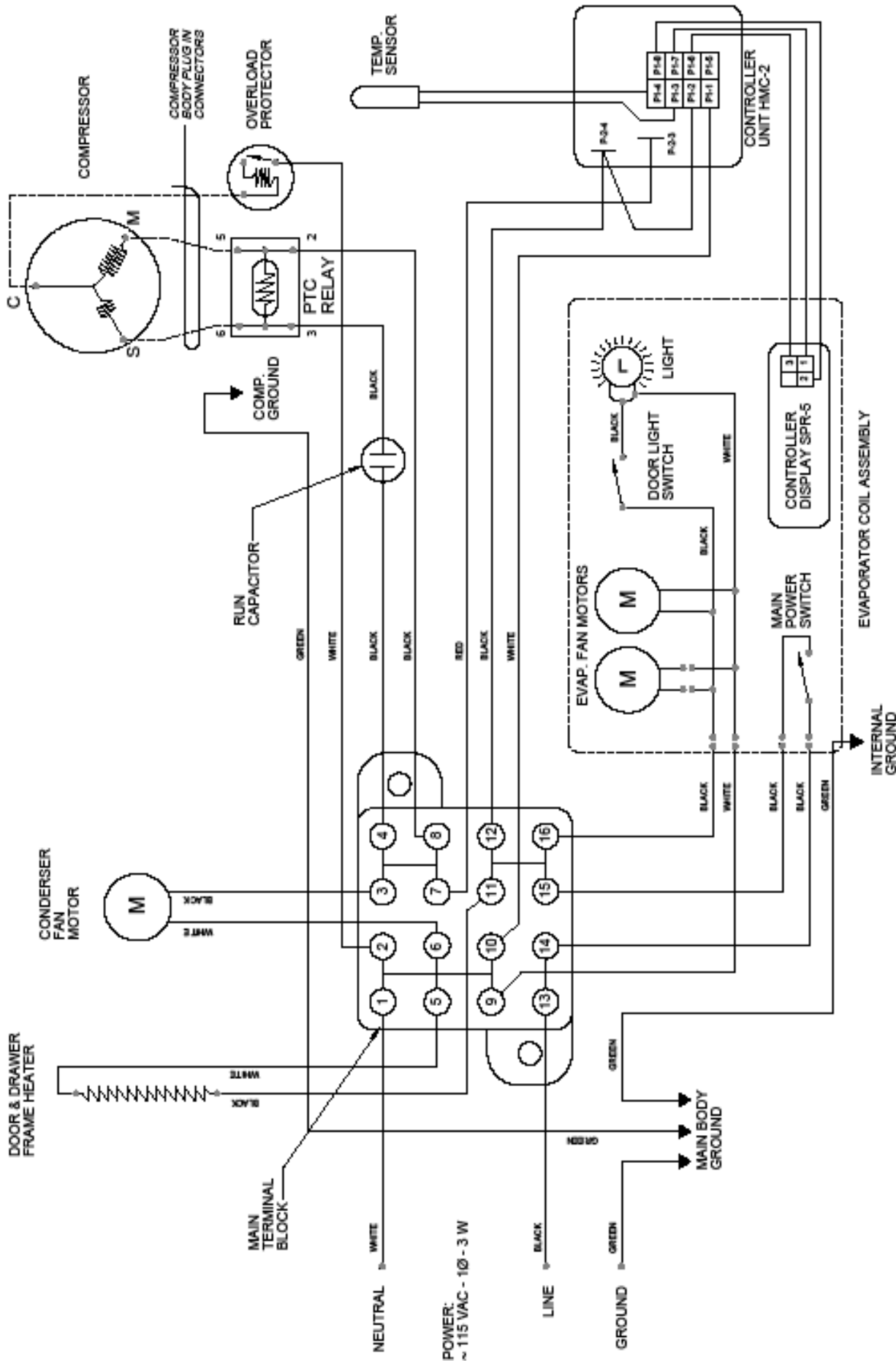

NOTE: CASE MUST BE GROUNDED

<p>THE INFORMATION CONTAINED IN THIS DRAWING IS THE PROPERTY OF ALFRESCO. IT IS TO BE USED ONLY FOR THE PROJECT AND EQUIPMENT SPECIFICALLY IDENTIFIED HEREIN. IT IS NOT TO BE REPRODUCED OR TRANSMITTED IN ANY FORM OR BY ANY MEANS, WITHOUT WRITTEN PERMISSION FROM ALFRESCO.</p>		<p>DRAWN BY: ADRIAN CRISCI</p>	<p>CREATED: 11/15/2006 3:39:17 PM</p>	<p>DRAWING NO.: W900-0044</p>
<p>CUSTOMER: SES</p>		<p>MATERIAL: RED</p>	<p>PROJECT TITLE: ARFG-42</p>	<p>PAGE SIZE: LETTER</p>
<p>ALFRESCO SUPERIOR EQUIPMENT SOLUTIONS 7019 EAST SALVISON AVENUE COMMERCIAL CA 90040</p>		<p>FINISH: LB8</p>	<p>DRAWING TITLE: ARFG-42 UNIT WITH RENAU CONTROL HMC-2</p>	<p>SHEET 1 OF 1</p>

ARXE-42 SERVICE DATA:

ELECTRICAL:

- VOLTAGE: 115 VAC
- FREQ: 60 Hz
- PHASE: 1
- AMPS: 2.8
- RLA: 1.1
- LRA: 9.6
- MCA: 3.1

REFRIGERATION:

REFRIGERANT 134A (9OZ)

SUCTION PRESSURE @ TEMP.

18 PSI @ 20°F

ACCEPTABLE RANGE: 12 - 21 PSI (COIL TEMP. 10°F - 24°F)

LIQUID PRESSURE @ TEMP.

125 PSI @ 100°F

ACCEPTABLE RANGE: 125 - 147 PSI (AMBIENT TEMP. 80°F - 90°F)

170 PSI @ 120°F

ACCEPTABLE RANGE: 170 - 197 PSI (AMBIENT TEMP. 100° - 110°F)



FOR SERVICE, CALL: 1 866 203 5607

When calling, please provide the following information: model number, serial number and date of installation, along with a brief description of the problem. The model number and serial number can be found on a plate located near the top of the inside left wall.

