

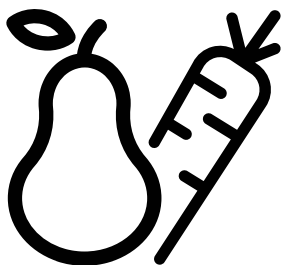

**Refrigerator**  
User Manual  
**Réfrigérateur**  
Manuel d'utilisation  
**Refrigerador**  
Manual del usuari

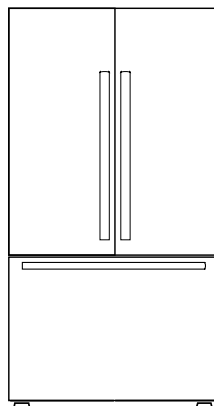

BFFD3624SS  
BFFD3624XSS  
BFFD3624ZSS



EN/FR/ES

57 5838 0000/BN

***Congratulations*** on the purchase of your new Beko Refrigerator! This refrigerator has been manufactured in modern facilities with the utmost care and meticulous quality controls. We are so confident in the quality of this product that we back it with a two year parts and labor warranty, and five years on the sealed system! Please read this entire user manual before using your product, to ensure you understand all of its features and benefits and know how to operate it properly. This manual should be kept in an easily accessible location and passed on to any future owners.

This guide will help you use the product quickly and safely.

Please read the user guide carefully before installing and operating the product.

- Always observe the applicable safety instructions.
- Please read any other documents provided with the product.
- Keep in mind that this user guide may apply to several product models. Please note the various symbols used throughout this manual and what they represent.

	<b>Important information and useful tips.</b>
	<b>Risk of life and property.</b>
	<b>Risk of electric shock.</b>
	<b>The product's packaging is made of recyclable materials, in accordance with the National Environment Legislation.</b>

<i>Fill this out and keep for future reference</i>	
<i>Model</i>	
<i>Serial No</i>	
<i>Date of Purchase</i>	
<i>Original Purchaser</i>	
<i>Dealer</i>	
<i>City</i>	
<i>State</i>	
<i>Zip Code</i>	
<i>Country</i>	

<b>1 Your Refrigerator</b>	<b>4</b>	<b>5 Preparation</b>	<b>20</b>
<b>2 Important Instructions Regarding Safety and Environment</b>	<b>6</b>	<b>6 Display and operating the product</b>	<b>21</b>
2.1 Intended use . . . . .	6	6.1 Indicator panel . . . . .	21
2.2 General Safety . . . . .	6	6.2 Sabbath Mode . . . . .	22
2.3 Hydrocarbon (HC) Warning . . . . .	8	6.3 Showroom Mode . . . . .	22
2.4 For Products with a Water Dispenser/Ice Machine . . . . .	8	6.4 High Temp Error . . . . .	22
2.5 Intended Use . . . . .	8	6.5 Freezing fresh food . . . . .	24
2.6 Children's Safety . . . . .	9	6.6 Recommendations for preserving frozen food . . . . .	24
2.7 Compliance with the WEEE Directive and Disposing the Waste Product: . . . . .	9	6.7 Placing the food . . . . .	24
2.8 Compliance with the RoHS Directive: . . . . .	9	6.8 Deep-freeze information . . . . .	24
2.9 Packaging Information . . . . .	9	6.9 Removing door shelves . . . . .	25
<b>3 Environmental instructions</b>	<b>10</b>	6.10 Moving the FlexiLift Door Shelf . . . . .	25
3.1 Compliance with the WEEE Directive and Disposing of the Waste Product: . . . . .	10	6.11 Glass shelves . . . . .	25
3.2 Compliance with RoHS Directive . . . . .	10	6.12 Crisper bins . . . . .	25
3.3 Package information . . . . .	10	6.13 Deli Drawer . . . . .	25
<b>4 Installation</b>	<b>11</b>	6.14 Humidity controlled crisper (EverFresh+) . . . . .	26
4.1 Before Installation . . . . .	15	6.15 Ice container . . . . .	26
4.2 Appropriate installation location . . . . .	15	6.16 Butter & Cheese section . . . . .	26
4.3 Inset installations . . . . .	16	6.17 Door flappers . . . . .	26
4.4 Electrical connection . . . . .	16	6.18 ActiveFresh Blue Light . . . . .	27
4.5 Adjusting the feet . . . . .	16	6.19 IonGuard . . . . .	27
4.6 Illumination lamp . . . . .	17	6.20 Odor filter . . . . .	27
4.7 Door/Drawer Open Warning . . . . .	17	6.21 Changing the temperature scale (Fahrenheit Celsius) . . . . .	27
4.8 Water connection . . . . .	17	<b>7. Maintenance and cleaning</b>	<b>28</b>
4.9 Connecting the water hose to the refrigerator	17	7.1 Avoiding bad odors . . . . .	28
4.10 Connecting the water line to the water supply . . . . .	17	7.2 Protecting the plastic surfaces . . . . .	28
4.11 Installing the Internal Water Filter . . . . .	18	<b>8. Troubleshooting</b>	<b>29</b>
4.12 Before using the water dispenser . . . . .	19		
4.12.1 Using the Ice Maker . . . . .	19		
4.13 Transportation of the product . . . . .	19		

# 1 Your Refrigerator

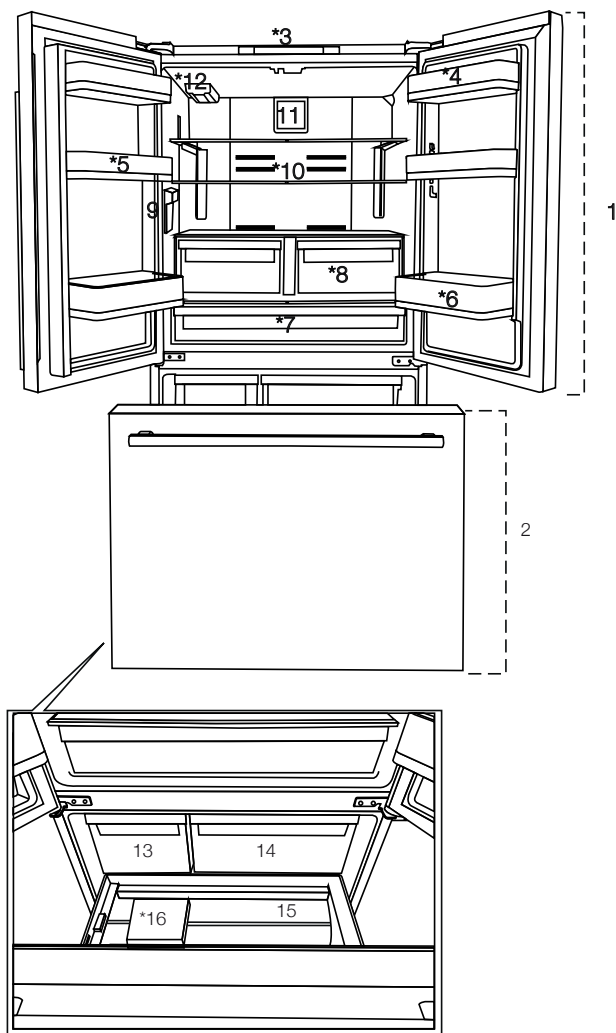

1- Fridge compartment

2- Bottom Freezer

3- Display/indicator panel

4- Butter & cheese section

5- FlexiLift Door Shelves

6- Bottle shelf

7- Deli Drawer

8- Crispers

9- Water dispenser

10- Adjustable glass shelf

11- Fan Cover

12- Water filter

13- Ice container

14- Frozen Food Storage Bin

15- Freezer Drawer

16- Separator



Figures in this user manual are schematic and may not match the product exactly. If the subject parts are not included in the product you have purchased, then those parts are only valid for other models.

## Refrigerator Shelf Weight Limitations

Fridge compartment cantilever shelves, those that only have rear supports, are tested for max 25 kgs (55 pounds) per each part.

Crispers will hold up to 15 kgs (33 pounds) per each one. Deli Drawer will hold up to 20 kgs (44 pounds).



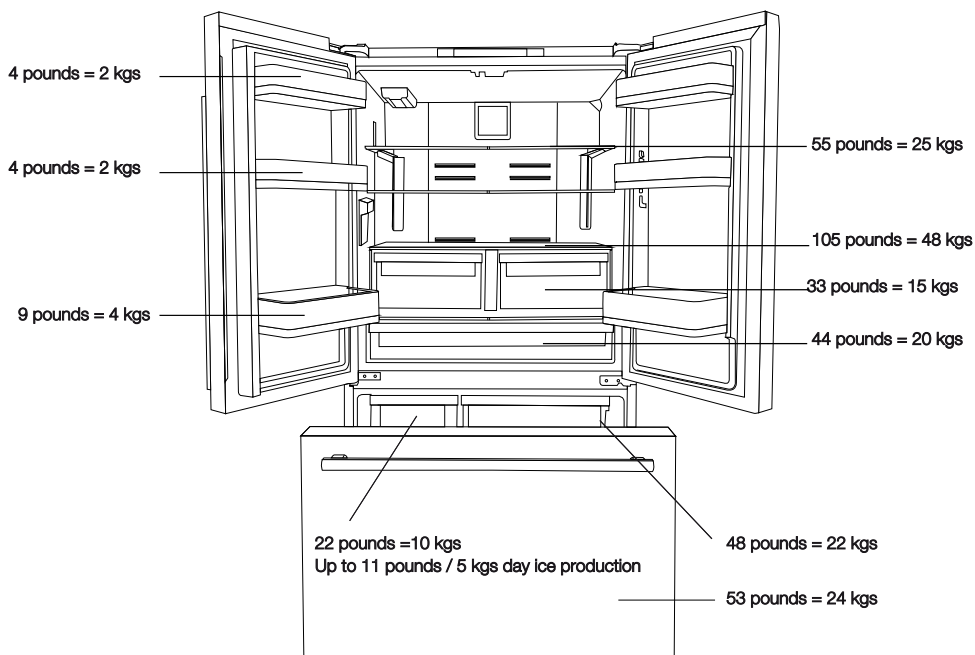

Ice container bin holds up to 10 kgs (22 pounds), it is for usage without ice. Freezer bin will hold up to 24 kgs (53 pounds) and drawer holds up to 30 kgs (66 pounds).



## 2 Important Instructions Regarding Safety and Environment

This chapter contains safety information that will help you avoid the risk personal injury or property damage. Failure to follow these instructions shall render any product warranty void.

### 2.1 Intended use

	<b>WARNING:</b> Keep ventilation openings, in the appliance enclosure or in the built-in structure, clear of obstruction.
	<b>WARNING:</b> Do not use mechanical devices or other means to accelerate the defrosting process, other than those recommended by the manufacturer.
	<b>WARNING:</b> Do not damage the refrigerant circuit.
	<b>WARNING:</b> Do not use electrical appliances inside the food storage compartments of the appliance, unless they are of the type recommended by the manufacturer.

This appliance is intended to be used in household and similar applications such as

- staff kitchen areas in shops, offices and other working environments;
- farm houses and by clients in hotels, motels and other residential type environments;
- bed and breakfast type environments;
- catering and similar non-retail applications.

### 2.2 General Safety

- This appliance is not intended for use by persons (including children) with reduced physical, sensory or mental capabilities, or lack of experience and knowledge, unless they have been given supervision or instruction concerning use of the appliance by a person responsible for their safety. Children should be supervised to ensure that they do not play with the appliance.
- Failure to follow the instructions and uncontrolled use of the product lead to dangerous results!
- Unplug the product if you encounter a failure during use.
- If the product malfunctions, it must not be operated until repaired by the authorised service provider. Risk of electric shock!
- Plug the product into a grounded socket protected by a fuse that corresponds to the value on its nameplate. Have a qualified electrician ground the product. Our company cannot be held responsible for damages resulting from the failure to use the product with a grounded socket pursuant to local regulations.
- Unplug the product when not in use.
- Never wash the product by spreading or pouring water onto it! Risk of electric shock!
- Never touch the plug with wet hands!
- Never unplug the product by pulling the cable. Always pull the plug by holding the socket.

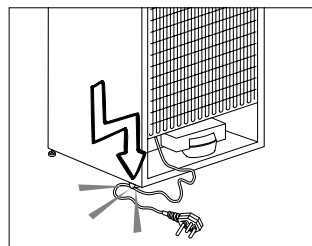

## Important instructions for safety and environment

- Do not plug the refrigerator if the wall socket is loose.
- Never connect your refrigerator to energy saving devices. Such systems are harmful to your product.
- Unplug the product during installation, care, cleaning and repairing procedures.
- Always have the **Authorised Service Provider** install the product and establish its electrical connections. The manufacturer cannot be held responsible for damages caused by procedures performed by unauthorised persons.
- Do not eat cone ice cream or ice cubes immediately after you take them out of the freezer compartment! This may cause frostbite in your mouth!
- Do not touch frozen food with wet hands! They may stick to your hand!
- Do not put bottled or canned liquid beverages in the freezer compartment. They may burst!
- Never use steam or steam cleaners to clean or defrost the refrigerator. Steam gets into contact with the live parts in your refrigerator, causing short circuit or electric shock!
- **WARNING:** When positioning the appliance, ensure the supply cord is not trapped or damaged. **If the supply cord is damaged, it must be replaced by the manufacturer, its service agent or similarly qualified persons in order to avoid a hazard.**
- **WARNING:** Do not locate multiple portable socket-outlets or portable power supplies at the rear of the appliance.
- Do not use mechanical devices or other means to accelerate the defrosting process other than those recommended by the manufacturer.
- Never use the parts in your refrigerator such as the door and drawer as a means of support or step. This may cause the product to tip over or damage the parts of it.
- Do not damage the parts where the refrigerant is circulating with drilling or cutting tools. The refrigerant that might blow out when the gas channels of the evaporator, pipe extensions or surface coatings are punctured causes skin irritations and eye injuries.
- Do not cover or block the ventilation holes in your refrigerator with any object.
- Place the beverage with higher proofs tightly closed and vertically.
- Do not use gaseous sprays near the product since there is the risk of fire or explosion!
- Flammable items or products that contain flammable gases (e.g. spray) as well as explosive materials should never be kept in the appliance.
- Do not place vessels filled with liquid onto the product. Splashing water on an electrical part may cause electric chock or the risk of fire.
- Do not store items that need precise temperature adjustment (such as vaccines, heat-sensitive medication, science materials etc.) in the refrigerator.
- If you are not going to use the product for a long time, unplug it and remove the food in it.
- If there is a blue light on the refrigerator, do not look at this light with optical tools.
- Exposing the product to rain, snow, sun or wind is dangerous in terms of electrical safety.
- In products with mechanical control (thermostat), wait for 5 minutes to plug in the product again after unplugging.
- Do not overload the refrigerator. Objects in the refrigerator may fall down when the door is opened, causing injury or damage. Similar problems may arise if any object is placed onto the product.





## Important instructions for safety and environment

- If the product has a door handle, do not pull the handle when re-locating the product. The handle might be loose.
- Be careful not to jam your hand or any other body part in the moving parts of the refrigerator.
- Do not put your hand or any other foreign materials into the ice machine while it is operating.

### 2.3 Hydrocarbon (HC) Warning

- If your product's cooling system contains R600a:

This gas is flammable. Therefore, pay attention not to damage the cooling system or the piping during use and transportation. If damaged, keep the product away from potential fire sources that may cause it to catch fire and ventilate the room where the product is placed.

	If the product is damaged and if you see gas leak, please keep away from the gas. It may cause frostbite when it gets into contact with the skin. (including R134)
	Ignore this warning if the cooling system of your product contains R134a.
	Type of gas used in the product is stated on the type plate which is on the left wall inside the refrigerator.
	<b>WARNING:</b> Never throw the product into fire for disposal.

### 2.4 For Products with a Water Dispenser/Ice Machine

- Use only drinking water. Do not fill the water tank with fruit juice, milk, fizzy beverages, alcoholic beverages or any other liquids incompatible for use in the water fountain. This may cause risk to your health and safety.
- Do not allow the children to play with the water dispenser or Ice Maker to prevent accidents and injuries.
- Do not insert your fingers or other objects inside the hole of the water dispenser, ice channel or inside the container of the Ice Maker. This may cause injuries or material damages.
- Pressure for cold water inlet shall be maximum 90 psi (620 kPa). If your water pressure exceeds 80 psi (550 kPa), use a pressure limiting valve in your mains system. If you do not know how to check your water pressure, ask for the help of a professional plumber.
- If there is a risk of water impact in your installation, always use a water impact protection equipment in that installation. Please consult professional plumbers if you are not sure if there is water impact in your installation.
- Do not make installation on the hot water inlet.
- Take the necessary measures against the freezing risk of the hoses. The water temperature operating range must be 0.6°C (33°F) minimum and 38°C (100°F) maximum.



## Important instructions for safety and environment



### WARNING:

Never connect the product to a cold water mains with a pressure of 550 kPa (80 psi) or above.

### 2.5 Intended Use

- This product has been designed for domestic use. It is not suitable for commercial use and it must not be used out of its intended use.
- It must be used only for storing food.
- The manufacturer will not take any responsibility for damages resulting from improper use or transport.
- Original spare parts will be available for 10 years after the purchase date of the product.

### 2.6 Children's Safety

- If there is a lock on the door of the product, the key should be kept out of the reach of children.
- Do not let children play with the product.



### CAUTION:

To Prevent A Child From Being Entrapped, Keep Out Of Reach Of Children And Not In The Vicinity Of Freezer Or Refrigerator.



### WARNING:

Before disposing your old refrigerator or freezer:

- Children may get locked inside.
- Remove the doors.
- Leave the shelves to prevent children from getting inside the product easily.

### 2.7 Compliance with the WEEE Directive and Disposing the Waste Product:

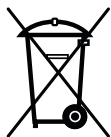

This product conforms to the EU WEE Directive (2012/19 EU). This product bears a classification symbol for waste electrical and electronic equipment (WEEE). This product has been manufactured from high quality parts and materials which can be reused and are suitable for recycling. Therefore, do not dispose the product with normal domestic waste or other waste at the end of its service life. Take it to a collection centre for recycling electrical and electronic equipment. Please consult local authorities to learn about the locations of such collection centres.

### 2.8 Compliance with the RoHS Directive:

The unit you have purchased conforms to the EU RoHS Directive (2011/65/EU). It does not contain harmful or prohibited materials specified in the Directive.

### 2.9 Packaging Information

- Packaging materials of the product have been manufactured from recyclable materials in accordance with our National Environment Regulations. Do not dispose the packaging materials with normal domestic waste or other types of waste. Take these materials to a recycling point designated by local authorities.

## 3 Environmental instructions

### 3.1 Compliance with the WEEE Directive and Disposing of the Waste Product:

This product complies with EU WEEE Directive (2012/19/EU). This product bears a classification symbol for waste electrical and electronic equipment (WEEE).



This symbol indicates that this product shall not be disposed with other household wastes at the end of its service life. Used device must be returned to official collection point for recycling of electrical and electronic devices. To find these collection systems please contact to your local authorities or retailer where the product was purchased. Each household performs important role in recovering and recycling of old appliance. Appropriate disposal of used appliance helps prevent potential negative consequences for the environment and human health.

### 3.2 Compliance with RoHS Directive

The product you have purchased complies with EU RoHS Directive (2011/65/EU). It does not contain harmful and prohibited materials specified in the Directive.

### 3.3 Package information



Packaging materials of the product are manufactured from recyclable materials in accordance with our National Environment Regulations. Do not dispose of the packaging materials together with the domestic or other wastes. Take them to the packaging material collection points designated by the local authorities.

# 4 Installation

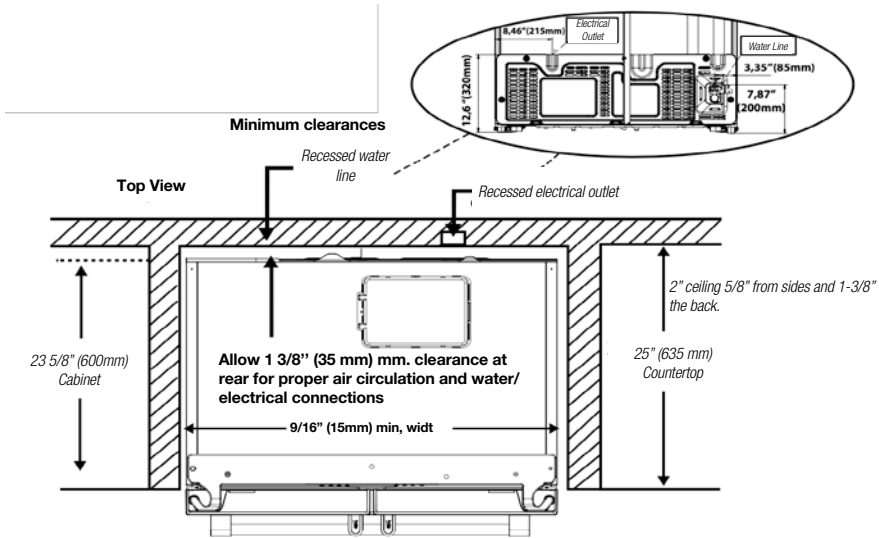
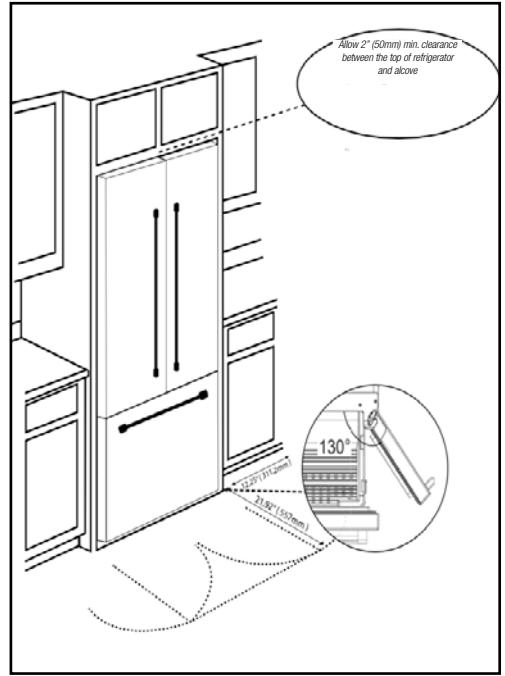
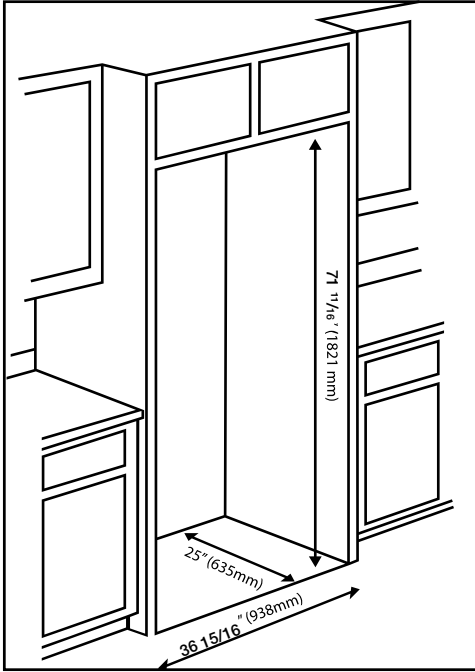

# Installation

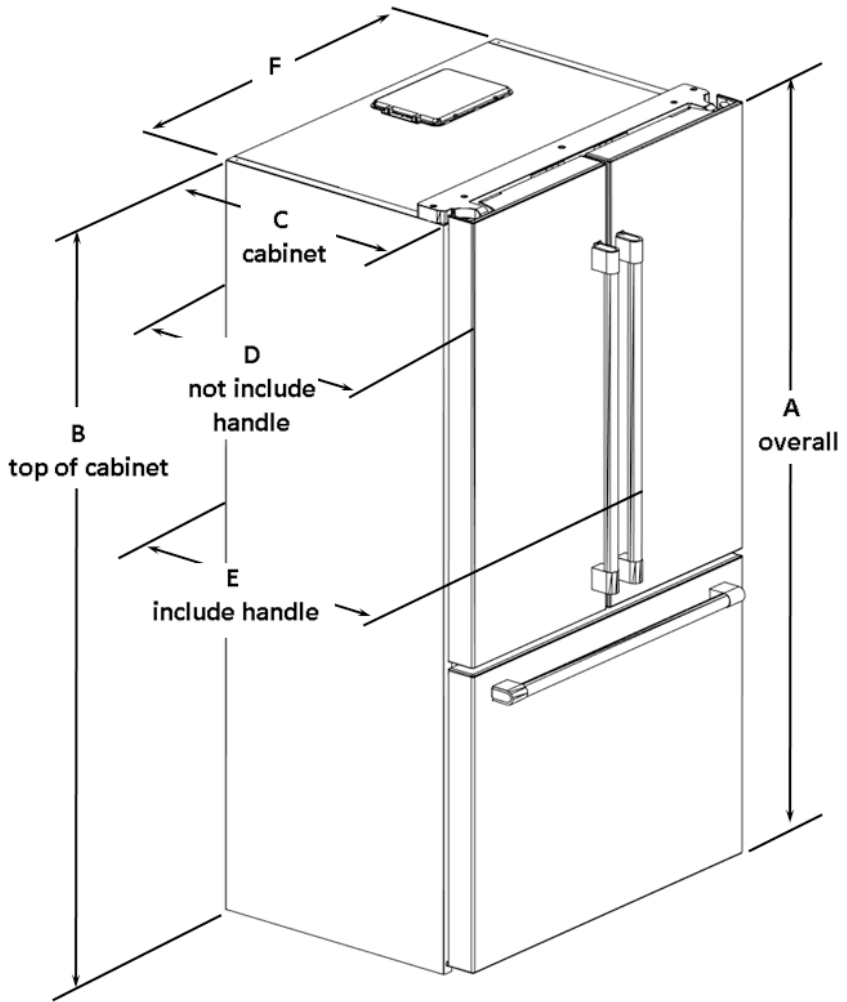

Height-Overall "A"	Height-TopOfCabinet "B"	Depth-CabinetOnly "C" "Q"	Depth-Without Handles "D"
69 3/4" ( 1771 mm )	67 5/16"( 1710 mm )	23 5/8" ( 600 mm )	26 13/16" ( 680.5 mm )
Depth-With Handles "E"	Width-Cabinet "F"	Depth-DrawerOpen "G"	TotalDepth-DrawerOpen "H"
29" ( 737 mm )	35 3/4"( 908 mm )	45 9/16" ( 1157 mm )	46 3/16" ( 1173.5 mm )

## Installation

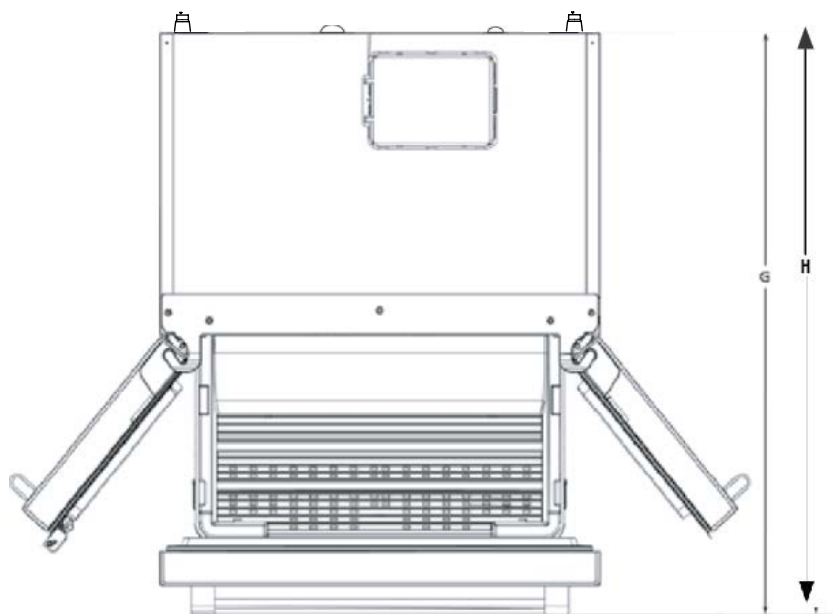

Height-Overall "A"	Height-TopOfCabinet "B"	Depth-CabinetOnly "C" "Q"	Depth-Without Handles "D"
69 3/4" ( 1771 mm )	67 5/16"( 1710 mm )	23 5/8" ( 600 mm )	26 13/16" ( 680.5 mm )
Depth-With Handles "E"	Width-Cabinet "F"	Depth-DrawerOpen "G"	TotalDepth-DrawerOpen "H"
29" ( 737 mm )	35 3/4"( 908 mm )	45 9/16" ( 1157 mm )	46 3/16" ( 1173.5 mm )

Min Clearance From the Top: 2" inches

Min Clearance From the Sides: 5/8" inches

Min Clearance From the Back: 1 3/8" inches

## Installation

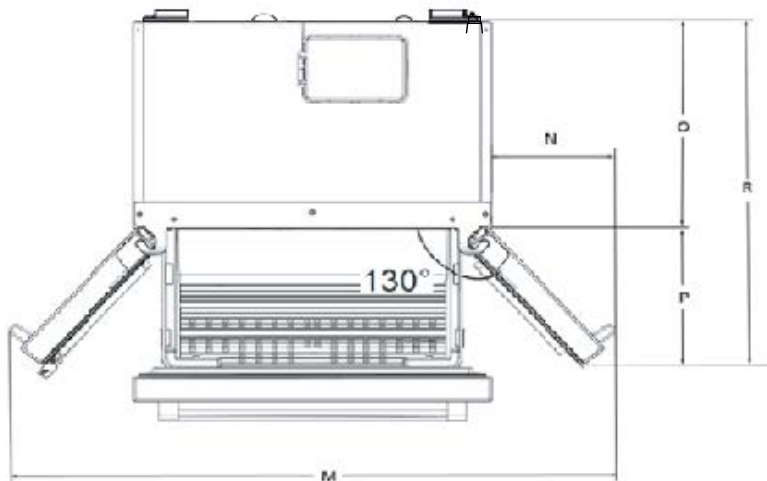
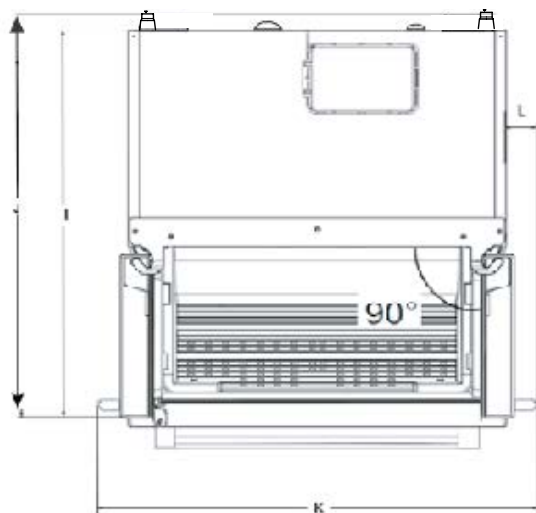

Depth-Doors Open90° "I"	Total Depth-Doors Open90° "J"	Width-Doors Open90° With Handles "K"	Width-Doors Open90°- From Cabinet To Handle "L"
42 1/4" ( 1072.6 mm )	43 1/16" ( 1094 mm )	41 11/16" ( 1059.2 mm )	3" ( 75.6 mm )
Width- Doors Open130°- From Handle To Handle "M"	Width-Doors Open 130°- From Cabinet To Handle "N"	Depth-Doors Open 130° "P"	Depth Doors Open 130° "R"
60 1/4" ( 1530.2 mm )	12 1/4" ( 311.2 mm )	15 3/8" ( 391 mm )	39" ( 991mm )

# Installation





## 4.1 Before Installation

- Before installing, be sure the opening measurements are sufficient to receive the product and that the appropriate electrical and plumbing connections are present.

Water line pressure values	psi	kPa	bar
Max Operating pressure:	90	620	6.2
Max pressure for limiting valve device requirement:	80	550	5.5

Electrical requirements	
Voltage	120V AC
Frequency	60 Hz
Current	15 A

- Refer to the nearest Authorized Service Agent for installation of the product. To make the product ready for use, make sure that the electricity installation is appropriate before calling the Authorized Service Agent. If not, call a qualified electrician to have any necessary arrangements carried out.
- Your product comes with an internal water filter. Part number of the filter is 4918450200 and you can use this part number when ordering replacement filters.

	Preparation of the location and electrical installation at the place of installation is under customer's responsibility.
	Plumbing: The refrigerator should only be connected to the cold water line.
	Product must not be plugged in during installation. Otherwise, there is the risk of death or serious injury!
	<b>WARNING:</b> Installation and electrical connections of the product must be carried out by the Authorized Service Agent. Manufacturer shall not be held liable for damages that may arise from procedures carried out by unauthorized persons.
	<b>WARNING:</b> Prior to installation, visually check if the product has any defects on it. If so, do not have it installed. Damaged products cause risks to your safety.

## 4.2 Appropriate installation location

- Install the product at least 12" (30 cm) away from heat sources such as cooktops, ovens, space heaters, radiators and stoves at least 2" (5 cm) away from electrical ovens. Product must not be subjected to direct sun light and kept in humid places after installation.
- Do not place the product on the materials such as rugs or carpets.
- Place the product on an even floor surface to prevent wobbling.
- Do not install the product in places where the temperature falls below 50°F/10°C.



If two refrigerators are to be installed side by side, there should be at least 1 1/2" (4 cm) distance between them.

- Make sure that sufficient room is provided around the appliance to ensure free air circulation.
- For proper functionality, there should be a gap of at least 1 3/8" (35 mm) between the refrigerator and the rear wall. **To ensure this, attach the gray, circular buffers, to be installed on the rear back metal cover of the refrigerator.** These are shipped inside the crisper drawer in the Fresh Food compartment.

## 4.3 Inset installations

- If the product will be installed within surrounding cabinetry or in an alcove, be sure there is adequate airflow around the product for proper functionality. This refrigerator requires at least 2" from the top of the unit to the ceiling or enclosure, 5/8" on each side and 1 3/8" in the back.
- For proper air flow when installed in an inset or alcove, be sure the parts shown below are installed on the unit.

### circulation part

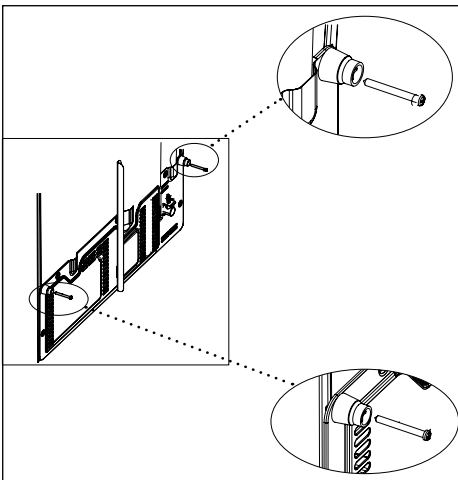
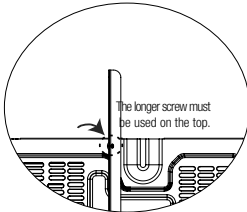
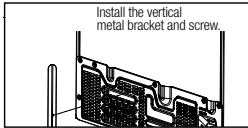
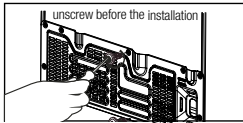

## 4.4 Electrical connection

- 120VAC, 60Hz, Dedicated 15Amp Circuit.
- GFCI outlets will provide added protection, but any failure of the GFCI could cause food spoilage, which is not covered by the manufacturer's warranty.
- Electrical connection must comply with national regulations.
- Power cable plug must be within easy reach after installation.
- Do not make connections via extension cables or multi-plugs.



**WARNING:** Damaged power cable must be replaced by the Authorized Service Agents.



**WARNING:** If the product has a failure, it should not be operated unless it is repaired by the Authorized Service Agent! There is the risk of electric shock!

## 4.5 Adjusting the feet

After moving the refrigerator into place, we recommend lowering the feet to secure the product in place. You can also adjust the feet if the product is not balanced. Twist the feet in the desired direction according to the illustration below. Adjusting the feet can also be used to align the doors.

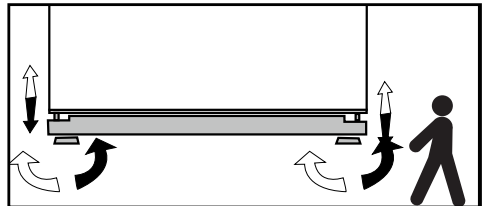

**WARNING:** First unplug the product. Product must not be plugged in when adjusting the feet. There is the risk of electric shock!



### 4.6 Illumination lamp

Do not attempt to repair yourself but call the Authorized Service Agent if the LED illumination lamps do not go on.

The lamp(s) used in this appliance is not suitable for household room illumination. The intended purpose of this lamp is to assist the user to place foodstuffs in the refrigerator/freezer in a safe and comfortable way.

### 4.7 Door/Drawer Open Warning

An audio warning signal will be given when the door of your product is left open for 1 minute. This warning will be muted when the door is closed or if any of the display buttons are pressed.

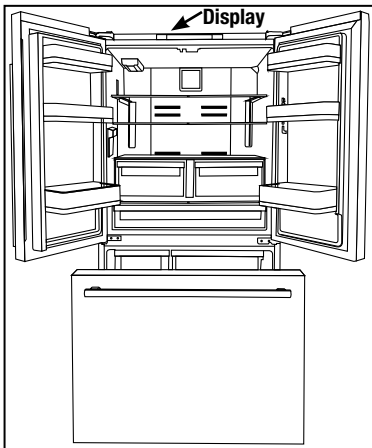

### 4.8 Water connection

First you must connect the water hose to the refrigerator.



**WARNING:** Refrigerator and the pump, if any, must be unplugged during connection.

### 4.9 Connecting the water hose to the refrigerator

1. Remove the valve channel cover (A) from the water inlet valve.
2. Connect the water line (C) to the inlet valve (B) and tighten by hand to secure it. It is not necessary to use pliers, but if there is a leak, you may tighten slightly with a pair of pliers.

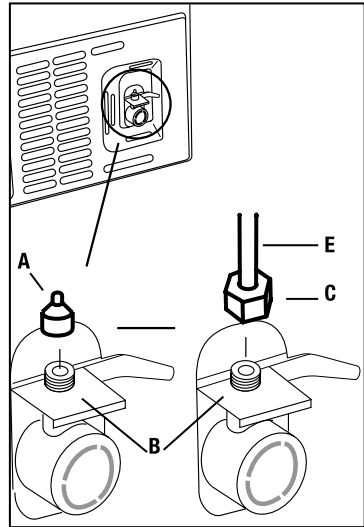

### 4.10 Connecting the water line to the water supply

Connect the water line to a water supply valve. If a valve is not present or you are not sure, consult a qualified plumber.

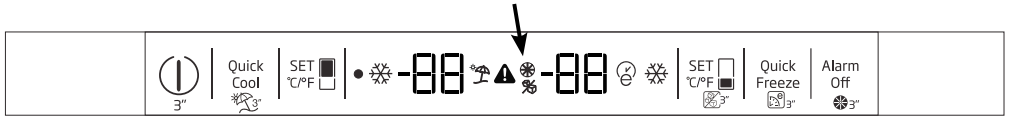



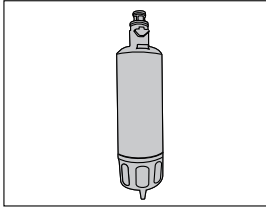

## 4.11 Installing the Internal Water Filter



Installing the internal water filter consists of two steps:

- Physically installing the filter
- Making adjustments to the display.

1. Press and hold the Freezer Temp Set key  for 3 seconds, or until the no ice icon appears in the display.
2. Slide the filter cover forward to open the filter compartment.
3. Tilt the bypass plug down and pull straight out to remove it.
4. Insert the filter into the housing and push it up to a horizontal position.
5. Close the filter cover and push it back into place.
6. Press and hold the Freezer Temp Set key  again for 3 seconds.  
You have successfully installed your filter.

The Filter End of Life warning  will appear in approximate 130 days, requiring you to replace the filter with the same steps as listed above. After replacing the filter, press and hold the “Alarm Off” key  for 3 seconds, or until the Filter End of Life Warning goes out in the display.

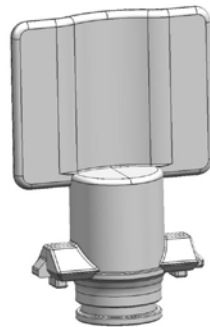
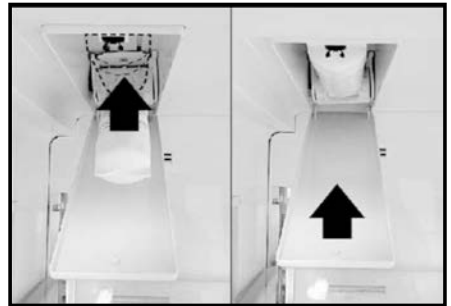

**BYPASS PLUG**

## Installation

### 4.12 Before using the water dispenser

The water system connections should be made by an Authorized Service Agent, with the necessary tools.

- The water system is designed to operate only with water. Do not attempt to connect to beverages such as soft drinks or juices.
- There will be air in the water line that must be bled out of the system before the initial use. To remove the air in the line, place a container beneath the water dispenser nozzle and depress the dispenser paddle for 1-2 minutes until only water comes out.
- The first 10 glasses of water should not be consumed. It will take approximately 12 hours before the water being dispensed cools down to refrigerated temperatures.
- Wait 1 second after releasing the dispenser paddle before removing your container, as this will reduce the potential for dripping into the dispenser tray.

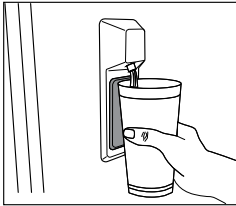

- Empty and clean the ice bin. Ice cubes can also stick together if they are left in the bin for too long.

### 4.13 Transportation of the product

1. Unplug the product before transporting it.
2. Remove water connections.
3. Secure the shelves, accessories, crisper and etc. in the refrigerator by adhesive tape before repackaging it.



Packaging must be tied with thick tapes or strong strips and the rules of transportation printed on the package must be followed.



**WARNING:** Packaging materials are dangerous for the children. Keep packaging materials in a safe place away from reach of the children.

### 4.12.1 Using the Ice Maker

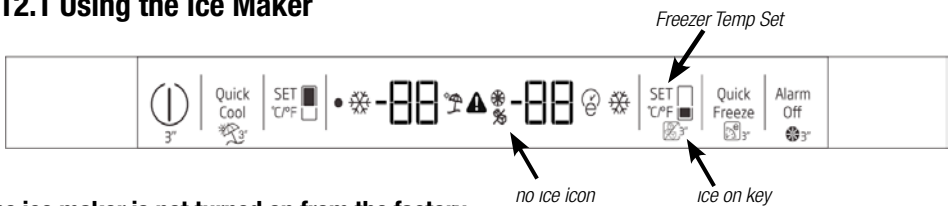

#### **The ice maker is not turned on from the factory.**

- To turn the ice maker on, press and hold the Freezer Temp Set key for 3 seconds, or until the no ice icon (❄️) disappears in the display. It will take approximately 1-2 days for the ice bin to fill with ice. If a power outage occurs while the refrigerator is running, the ice cubes may partially melt and then stick together when the re-freeze. If the power outage is prolonged, the ice cubes may turn into water, causing leakage. If such a problem occurs.

## 5 Preparation

Before starting to use the product, check that all preparations are made in accordance with the instructions in sections "Important instructions for safety and environment" and "Installation".

- Clean the interior of the refrigerator as recommended in the "Maintenance and cleaning (Page 25)" section. Ensure that interior is dry before operating.
- Plug the refrigerator into the grounded wall outlet. When the door is opened the interior illumination will turn on.
- Run the refrigerator without putting any food for 6 hours and do not open its door unless absolutely required.
- Do not allow the food to touch the temperature sensor in fresh food compartment.



You will hear a noise when the compressor starts up. The liquids and gases sealed within the refrigeration system may also give rise to noise, even if the compressor is not running and this is quite normal.



Front edges of the refrigerator may feel warm. This is normal. These areas are designed to be warm to avoid condensation.

- To allow the fresh food compartment keep its ideal storage temperature, sensor must not be covered by food.

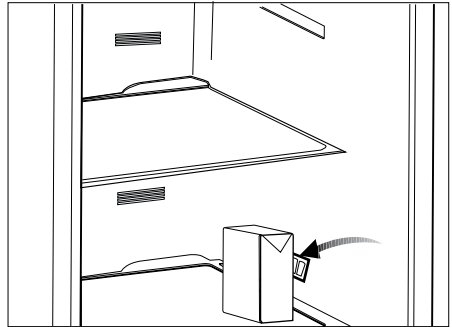
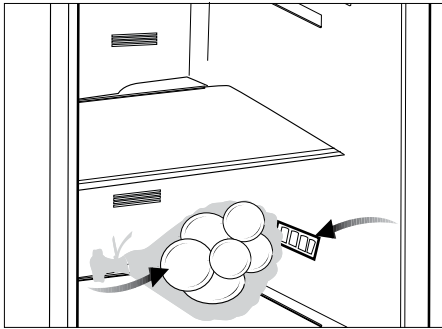

# 6 Display and operating the product

## 6.1 Indicator panel

Touch-control indicator panel allows you to set the temperature and control the other functions of the refrigerator. Just press the relevant buttons for function settings.

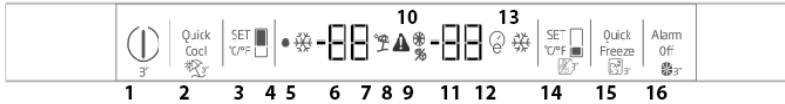

**Note: Keys 2, 14, 15, and 16 have two functions. The second function has a “b” after the number below.**

- 1-Power key**  
Press and hold this key for 3 seconds to turn the refrigerator on and off.
- 2-Quick Cool key**  
Press this key to turn on the Quick Cool option, which drops the temperature in the Fresh Food compartment to its lowest setting (33 F°) for two hours. It will return to the previously set temperature after this time.
- 2b. Vacation Mode**  
If you hold the Quick Cool key for three seconds, you will turn on the Vacation Mode. In Vacation mode the Fresh Food compartment will stay at 50 F° while the Freezer maintains its set temperature. You will know that Vacation Mode is on by the dashes in the Fresh Food temperature display (6) and the illumination of the “beach umbrella” (7). Press and hold the Quick Cool key for 3 seconds to turn this option off.
- 3- Fresh Food Temperature set key**  
Press this key to change the temperature in the Fresh Food section from between 33 F° and 40 F°. The set temperature will be displayed in the Fresh Food temperature display (6).
- 4- Power “off” indicator light**  
A red dot will be illuminated when the refrigerator is plugged in, but NOT turned on. Once the refrigerator is turned on, the red light will go out.
- 5-Quick Cool Indicator**  
A “snowflake” icon to the left of the Fresh Food temperature display lets you know the Quick Cool option is on.
- 6-Fresh Food Temperature display**  
The set temperature in the Fresh Food compartment will be displayed here.
- 7-Vacation Mode indicator**  
The “beach umbrella” icon will be illuminated when Vacation Mode is turned on. You will also see dashes in the Fresh Food temperature display.
- 8- High Temp Warning**  
The red exclamation point will be illuminated if the temperature in Freezer is too high after the initial 72 hours of operation. (See page 19 for more details)
- 9-Ice Maker Off icon**  
The ice cubes with a slash through them will be illuminated when the ice maker is turned off.
- 10-Filter Change icon**  
The filter reset icon will illuminate when it is time to replace the water filter. (For instructions on how to do that, see page 12.)
- 11-Freezer Compartment temperature display**  
The set temperature of the Freezer compartment will be shown in this display.
- 12-Eco-Extra icon**  
The Eco-Extra icon will be illuminated when Eco-Extra is turned on. (See 15b for more information on this option.)
- 13-Quick Freeze Indicator**  
A snowflake icon to the right of the Freezer Compartment temperature display will be illuminated when the Quick Freeze option is turned on. (See 15 for information on that option.)
- 14-Freezer Temperature set key**  
Press this key to adjust the temperature in the Freezer compartment, between -8 F° and 5 F°.
- 14.b. Ice Maker on/off key**  
Press and hold the Freezer Temp Set key for 3 seconds to turn the Ice Maker on and off.
- 15-Quick Freeze key**  
Press and hold the Quick Freeze key to turn on the Quick Freeze option, which will drop the temperature in the Freezer to its lowest setting (-8 F°) for 24 hours. After this time it will return to the previously set temperature.
- 15b. Eco-Extra key**  
Press and hold the Quick Freeze key for 3 seconds to turn on the Eco-Extra option. In this mode the refrigerator will operate in its most efficient way. It will only stay in this mode while the doors remain closed.
- 16. Alarm Off key**  
If the doors remain open for more than 1 minute, or if an error is detected, an alarm will sound. If this key is pressed, the alarm will be silenced.
- 16b. Filter Change Timer Reset**  
If the filter change light comes on (10), press and hold the Alarm Off key for 3 seconds to reset the timer. The filter reset light will come on after 130 days of operation.



**\*optional:** Figures in this user manual are schematic and may not match the product exactly. If the subject parts are not included in the product you have purchased, then those parts are valid for other models.

## Display and operating the product

### 6.2 Sabbath Mode

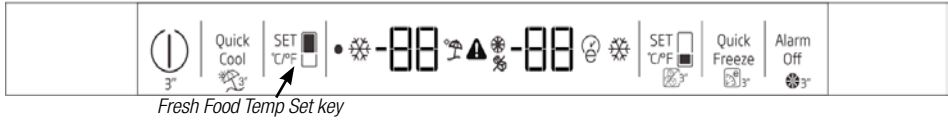

Press the Fresh Food Temp Set Function key for 3 seconds to activate or deactivate the Sabbath Mode. When Sabbath Mode is activated, the display, alarm, door opening or light buttons will not function. "SA" will appear in the display. The cooling algorithm is set according to the sabbath fashion. If the user does not deactivate the Sabbath mode, the refrigerator will automatically cancel it in 72 hours.

### 6.3 Showroom Mode



Showroom Mode is an option primarily used in dealer's showrooms. It allows the product to be turned on without the operation of the fans and cooling system. To activate this mode, Press and hold "Power" & "Alarm Off" until PS 0 appears. Change the 0 to an 8 by pressing the "Freezer Temperature Set" key. Then press "Fresh Food Temperature Set" key to activate. To deactivate, press and hold the "Power" & "Alarm Off" again.

### 6.4 High Temp Error



The High Temp Error icon is displayed when the Freezer temperature is too warm after the initial 72 hours of operation. If the Freezer temperature reaches 28F° (-2.2°C) or higher, and doesn't drop below 16 F° (-9°C) within 12 hours, the High Temp Error icon will be illuminated, an alarm will sound and the set temperature and highest temperature reached in the Freezer will alternate in the display. If you press the "Alarm Off" key, the alarm will be silenced, but the icon and flashing temperature will continue until the Freezer gets below 16F° (-9°C). If the Freezer does not cool below 16F° (-9°C) in the next 3.5 hours, the audible alarm will return. The audible alarm can be silenced again with the "Alarm Off" key. If the error continues to return, the doors should be checked for proper closure and sealing. A common cause of this error is a power failure in the circuit to which the refrigerator is connected. If the icon continues to return, an authorized service agent should be called to inspect the unit.

## Operating Temperatures

<b>Freezer Compartment Setting</b>	<b>Fridge Compartment Setting</b>	<b>Explanations</b>
5F°/-15°C	39 F° /4°C	This is the normally recommended setting.
-4F°/-20°C	37 F° / 3°C	These settings are recommended when the ambient temperature exceeds 86 F° /30°C.
Quick Freeze	39 F° / 4°C	Use when you wish to freeze your food in a short time. Your refrigerator will return to its previous mode when the process is over.
5 F° /-15°C or colder	Quick Fridge	Use this function when you place large quantities into the fridge compartment or when you need to cool your food quickly. It is recommended that you activate Quick Fridge function 4-8 hours before placing the food in the compartment.

## Operating the product

### 6.5 Freezing fresh food

- Wrap the food or place them in a covered container before putting them in the refrigerator.
- Hot food and beverages must cool down to room temperature before putting them in the refrigerator.
- The food that you want to freeze must be fresh and in good quality.
- Pack the food in an airtight manner to prevent them from drying even if they are going to be stored for a short time.
- Materials to be used for packaging must be tear-proof and resistant to cold, humidity, oils and acids and they must also be airtight. All packaging must be completely sealed.
- Frozen food must be used immediately after they are thawed and they should never be re-frozen.
- Do not freeze excessively large quantities of food at one time. The quality of the food is best preserved when it is frozen right through to the core as quickly as possible.
- Placing warm food into the freezer compartment causes the cooling system to operate continuously until the food is frozen solid.

### 6.6 Recommendations for preserving frozen food

To ensure the quality achieved by the frozen food manufacturer and food retailer is maintained, follow the steps listed below:



1. Put packets in the freezer as quickly as possible after purchase.
2. Make sure that contents of the package are labelled and dated.
3. Check whether the "Use By" and "Best Before" dates on the packaging are exceeded or not.

### 6.7 Placing the food

Freezer compartment shelves	Various frozen food such as meat, fish, ice cream, vegetables and etc.
Fridge compartment shelves	Food in pans, covered plates and closed containers
Fridge compartment door shelves	Small and packaged food or beverage (such as milk, fruit juice, beer and etc.)
Crisper	Vegetables and fruits
Deli drawer	Delicatessen products (cheese, butter, salami and etc.)

### 6.8 Deep-freeze information

You can keep the freshness of food for many months (at 5 °F / -15°C or lower temperatures in the deep freeze).

	Divided the food into portions according to your family's daily or meal based consumption needs.
	Pack the food in an airtight manner to prevent them from drying even if they are going to be stored for a short time.

- Materials necessary for packaging:
- Cold resistant adhesive tape
- Self adhesive label
- Rubber rings
- Pen



## Operating the product

### 6.9 Removing door shelves

You can remove the door shelves to clean them. First, empty the food inside them.

Push the desired shelf up to remove it.

Do not remove the door shelf when there is food in it.

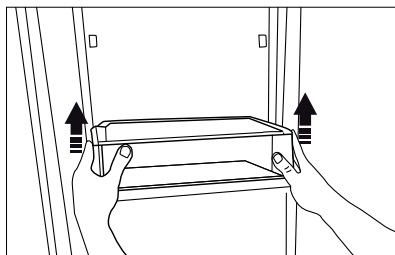

### 6.10 Moving the FlexiLift Door Shelf

#### \*optional

Moving the FlexiLift door shelf can be fixed in 3 different positions.

In order to move the shelf, push the buttons on the side evenly. Shelf will be movable.

Move the shelf up or down.

When the shelf is in the position that you want, release the buttons. Rack will be fixed again in the position where you have released the buttons.

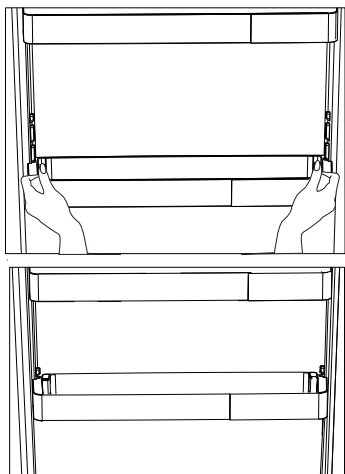

### 6.11 Glass shelves

You can remove the glass shelves to clean them. Be careful when removing the shelves since they are heavy.

### 6.12 Crisper bins

#### (in some models)

Crisper bins allow you to prepare the food for freezing. You can also use these compartments to store your food at a temperature a few degrees below the fridge compartment.

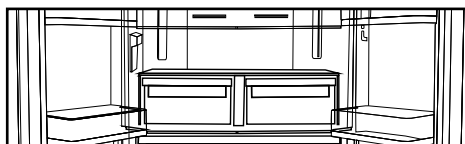

You can increase the inner volume of your refrigerator by removing any of the chiller compartments:

1. Pull the compartment towards yourself until it stops.
2. Lift the compartment about 7/16" (1cm) up and pull towards yourself to remove it from its seating.

### 6.13 Deli Drawer

The Deli Drawer is designed with cool air circulation intensified around it. This allows for items stored in the drawer to be generally fresh food compartment than average Fresh Food temperatures.

If required, remove door shelves prior to Deli Drawer removal

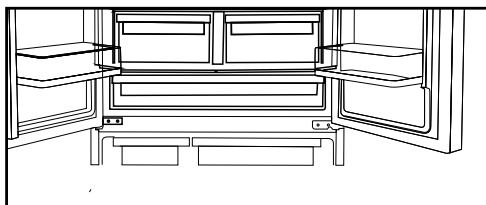

## Operating the product

### 6.14 Humidity controlled crisper (EverFresh+)

Humidity levels of the vegetables and fruit are kept under control with the feature of humidity-controlled crisper and the food is ensured to stay fresh longer.

We recommend you to place the leafy vegetables such as lettuce, spinach and the vegetables which are sensitive to humidity loss, in a horizontal manner as much as possible inside the crisper, not on their roots in a vertical position.

While the vegetables are being placed, individual weights of the vegetables should be taken into consideration. Heavy and hard vegetables should be put at the bottom of the crisper and the lightweight and soft vegetables should be placed on top.

Never leave vegetables inside the crisper in their bags. This will cause them to decompose prematurely. If you wish to keep vegetables separate, use perforated paper bags or similar materials to do so. Certain fruits such as pears, apricots, peaches or apples generate high levels of ethylene gas. Do not place them with other fruits and vegetables which do not, as this will cause them to decompose faster.

### 6.15 Ice container

The ice container is used to collect ice produced by the ice maker. Do not put water in it to make ice as it may break. The ice container is not used for storing foods.



The ice machine may drop ice when the ice container is opened.

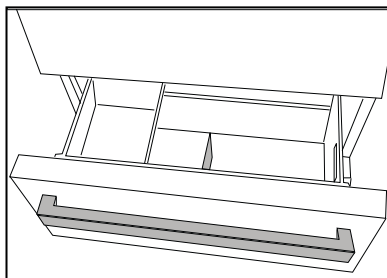

### 6.16 Butter & Cheese section

Store food such as butter, cheese and margarine in this section.

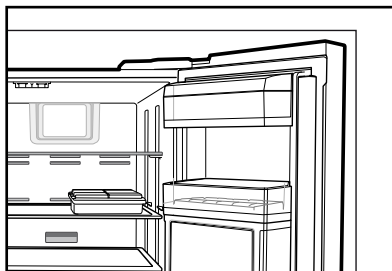

### 6.17 Door flappers

Movable door flapper is intended to prevent the cold air inside the refrigerator from escaping outside. Sealing is provided when the gaskets on the door presses on the surface of the door flapper while the fridge compartment doors are closed.

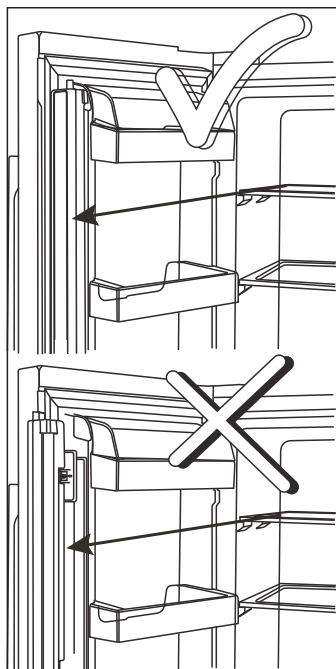

## Operating the product

### 6.18 ActiveFresh Blue Light

Crispers of the refrigerator are illuminated with blue light. Food stored in the crispers continue their photosynthesis by means of the wavelength effect of blue light and thus, preserve their freshness and preserves their vitamin content.

### 6.19 IonGuard (in some models)

Air is ionized by means of the ionizer system in the fridge compartment air duct. Thanks to this system, air-borne bacteria and odorizing molecules are removed from the air.

### 6.20 Odor filter

Odor filter in the air duct of the fridge compartment prevents build-up of unpleasant odors in the refrigerator.

### 6.21 Changing the temperature scale (Fahrenheit ↔ Celsius)

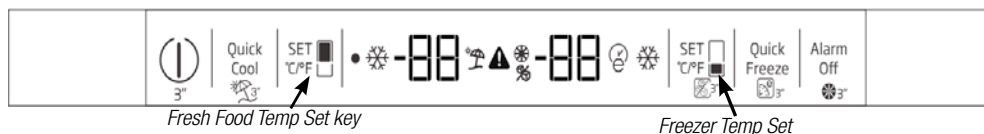

After the product is energized, press and hold the Fresh Food Temp Set and Freezer Temp Set buttons together for 3 secs.

The temperature scale change is completed. Reverse these steps to switch back to the original scale.

## 7. Maintenance and cleaning

The life of the product is extended and common problems are reduced, if it is cleaned regularly.



**WARNING:** Unplug the product before cleaning it.

- Never use gasoline, benzene or similar substances for cleaning purposes.
- Never use any sharp and abrasive tools, soap, household cleaners, detergent and wax polish for cleaning.
- Dissolve one teaspoon of baking soda in 1 pint of water. Soak a cloth with the solution and wring it thoroughly. Wipe the interior of the refrigerator with this cloth and dry thoroughly.
- Make sure that no water enters the lamp housing and other electrical items.
- If you will not use the refrigerator for a long period of time, unplug it, remove all food inside, clean it and leave the door ajar.
- Check regularly that the door gaskets are clean. If not, clean them.
- To remove door and body shelves, remove all of its contents.
- Remove the door shelves by pulling them up. After cleaning, slide them from top to bottom to install.
- Never use cleaning agents or water that contain chlorine to clean the outer surfaces and chromium coated parts of the product. Chlorine causes corrosion on such metal surfaces

### 7.1 Avoiding bad odors

Materials that may cause odor are not used in the production of our refrigerators. However, due to inappropriate food preserving conditions and not cleaning the inner surface of the refrigerator as required can bring forth the problem of odor. Pay attention to following to avoid this problem:

- Keeping the refrigerator clean is important. Food residuals, stains, etc. can cause odor. Therefore, clean the refrigerator with baking soda dissolved in water every 15 days. Never use detergents or soap.
- Keep the food in closed containers. Microorganisms spreading out from uncovered containers can cause unpleasant odors.
- Never keep the food that is past its expiration date or has spoiled in the refrigerator.

### 7.2 Protecting the plastic surfaces

Do not put liquid oils or oil-cooked meals in your refrigerator in unsealed containers as they damage the plastic surfaces of the refrigerator. If oil is spilled or smeared onto the plastic surfaces, clean and rinse the relevant part of the surface at once with warm water.

## 8. Troubleshooting

Check this list before contacting a servicer. Doing so will save you time and money. This list includes frequent complaints that are not related to faulty workmanship or materials. Certain features mentioned herein may not apply to your product.

### **The refrigerator is not working.**

- The power plug is not fully seated. >>> Plug it in outlet completely into the socket.
- The fuse connected to the socket powering the product or the main fuse is blown. >>> Be sure the unit is turned on. A single red light in the display means the product is plugged in but not turned on. Press and hold the Power button for three seconds to turn the unit on.
- **Condensation on the side wall of the fresh food compartment (MULTI ZONE, COOL, CONTROL and FLEXI ZONE).**
- The door is opened too frequently >>> Take care not to open the product's door too frequently.
- The environment is too humid. >>> Do not install the product in humid environments.
- Foods containing liquids are kept in unsealed holders. >>> Keep the foods containing liquids in sealed holders.
- The product's door is left open. >>> Do not keep the product's door open for long periods.
- The thermostat is set to too low temperature. >>> Set the thermostat to appropriate temperature.

### **Compressor is not working.**

- In case of sudden power failure or pulling the power plug off and putting back on, the gas pressure in the product's cooling system is not balanced, which triggers the compressor thermic safeguard. The product will restart after approximately 6 minutes. If the product does not restart after this period, contact a servicer.
- Defrosting is active. >>> This is normal for a fully-automatic defrosting product. The defrosting is carried out periodically.
- The product is not plugged in. >>> Make sure the power cord is plugged in.
- The temperature setting is incorrect. >>> Select the appropriate temperature setting.
- The power is out. >>> The product will continue to operate normally once the power is restored.

### **The refrigerator's operating noise is increasing while in use.**

- The product's operating performance may vary depending on the ambient temperature variations. This is normal and not a malfunction.

### **The refrigerator runs too often or for too long.**

- The new product may be larger than the previous one. Larger products will run for longer periods.
- The room temperature may be high. >>> The product will normally run for long periods in higher room temperature.
- The product may have been recently plugged in or a new food item is placed inside. >>> The product will take longer to reach the set temperature when recently plugged in or a new food item is placed inside. This is normal.
- Large quantities of hot food may have been recently placed into the product. >>> Do not place hot food into the product.
- The doors were opened frequently or kept open for long periods. >>> The warm air moving inside will cause the product to run longer. Do not open the doors too frequently.
- The freezer or fresh food compartment door may be ajar. >>> Check that the doors are fully closed.
- The product may be set to temperature too low. >>> Set the temperature to a higher degree and wait for the product to reach the adjusted temperature.
- The fresh food compartment or freezer door washer may be dirty, worn out, broken or not properly settled. >>> Clean or replace the gasket. Damaged / torn door washer will cause the product to run for longer periods to preserve the current temperature.

## Troubleshooting

### **The freezer temperature is very low, but the fresh food compartment temperature is adequate.**

- The freezer compartment temperature is set to a very low degree. >>> Set the freezer compartment temperature to a higher degree and check again.

### **The fresh food compartment temperature is very low, but the freezer temperature is adequate.**

- The fresh food compartment temperature is set to a very low degree. >>> Set the freezer compartment temperature to a higher degree and check again.

### **The food items kept in fresh food compartment drawers are frozen.**

- The fresh food compartment temperature is set to a very low degree. >>> Set the freezer compartment temperature to a higher degree and check again.

### **The temperature in the fresh food compartment or the freezer is too high.**

- The fresh food compartment temperature is set to a very high degree. >>> Temperature setting of the fresh food compartment has an effect on the temperature in the freezer compartment. Wait until the temperature of relevant parts reach the sufficient level by changing the temperature of fresh food compartment or freezer compartments.
- The doors were opened frequently or kept open for long periods. >>> Do not open the doors too frequently.
- The door may be ajar. >>> Fully close the door.
- The product may have been recently plugged in or a new food item is placed inside. >>> This is normal. The product will take longer to reach the set temperature when recently plugged in or a new food item is placed inside.
- Large quantities of hot food may have been recently placed into the product. >>> Do not place hot food into the product.

### **Shaking or noise.**

- The ground is not level or firm. >>> If the product is shaking when moved slowly, adjust the feet to balance the product. Also make sure the ground is sufficiently firm to bear the product.
- Any items placed on the product may cause noise. >>> Remove any items placed on the product.

### **The product is making noise of liquid flowing, spraying etc.**

- The product's operating principles involve liquid and gas flows. >>> This is normal and not a malfunction.

### **There is sound of wind blowing coming from the product.**

- The product uses a fan for the cooling process. This is normal and not a malfunction.

### **There is condensation on the product's internal walls.**

- Hot or humid weather will increase icing and condensation. This is normal and not a malfunction.
- The doors were opened frequently or kept open for long periods. >>> Do not open the doors too frequently; if open, close the door.
- The door may be ajar. >>> Fully close the door.

### **There is condensation on the product's exterior or between the doors.**

- The ambient weather may be humid, this is quite normal in humid weather. >>> The condensation will dissipate when the humidity is reduced.

### **The interior smells bad.**

- The product is not cleaned regularly. >>> Clean the interior regularly using sponge, warm water and carbonated water.
- Certain containers and packaging materials may cause odor. >>> Use containers and packaging materials free of odor.

## Troubleshooting

- The foods were placed in unsealed containers. >>> Keep the foods in sealed containers. Micro-organisms may spread out of unsealed food items and cause bad odor. Remove any expired or spoiled foods from the product.

### **The door is not closing.**

- Food packages may be blocking the door. >>> Relocate any items blocking the doors.
- The product is not standing in full upright position on the ground. >>> Adjust the stands to balance the product.
- The ground is not level or firm. >>> Make sure the ground is level and sufficiently firm to bear the product.

### **The vegetable bin is jammed.**

- The food items may be obstructing with the upper section of the drawer. >>> Reorganize the food items in the drawer.

### **If The Surface Of The Product Is Hot.**

- High temperatures may be observed between the two doors, on the side panels and at the rear grill while the product is operating. This is normal and does not require service maintenance! Be careful when touching these areas.



#### **WARNING:**

If the problem persists after following the instructions in this section, contact your vendor or an Authorized Service. Do not try to repair the product.



#### **WARNING:**

- This product can expose you to chemicals including Nickel (Metallic) which is known to the State of California to cause cancer.
- For more information go to [www.P65Warnings.ca.gov](http://www.P65Warnings.ca.gov)
- Note : Nickel is a component in all stainless steel and some other metal components.