

Blomberg

Induction Range

User Manual

IMPORTANT

Installer should leave these instructions with appliance.
Consumer should read these instructions before using the appliance and should retain them for future reference.

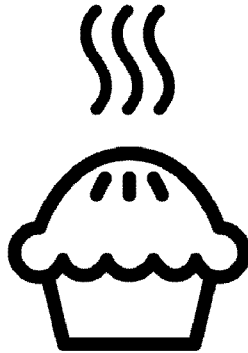

BIRU24102SS

EN

285.3056.31/R.AA/4.04.2024

7732187992



RECYCLED &
RECYCLABLE PAPER



Important Safety Instructions

Read and save these instructions

TO PREVENT TIPPING: If the information in this manual is not followed exactly, a fire or explosion may result causing property damage, personal injury or death.



WARNING:

"A child or adult can tip the range and be killed.

Install the anti-tip device packed with range to the structure wall or floor."

"Engage the range to the anti-tip device by sliding range so that rear foot of the range slides in to the bracket as shown in Figure.2 and 3."

"Re-engage the anti-tip device if the range is moved.

See installation instructions.

"Failure to follow these instructions can result in in death or serious burns to children or adults."



WARNING:

- **DO NOT OPERATE THE RANGE WITHOUT ANTI-TIP DEVICE IN PLACE AND ENGAGED**

"After installation cautiously grip the rear of the range to ensure the anti-tip bracket is engaging the rear foot of range."

Check for proper installation and use of the anti-tip bracket. Carefully tip the range forward pulling from the back to ensure that the anti-tip bracket engages the range leg and prevents tip-over. Range should not move more than 1" (25 mm).



IMPORTANT:

This appliance is intended for normal household use only. It is not approved for outdoor or other non-household uses (including sea or air-going vessels). See the Statement of Limited Warranty. If you have any questions, contact the manufacturer.

Do not repair or replace any part of the appliance unless specifically recommended in this manual. Refer all servicing to a factory authorized service center.

Explanation of symbols

Throughout this User Manual the following symbols are used:



Important information or useful hints about usage.



Warning for hazardous situations with regard to life and property.



Warning for electric shock.



Warning for risk of fire.



Warning for hot surfaces.

DANGER indicates a hazardous situation which, if not avoided, will result in death or serious injury.

WARNING indicates a hazardous situation which, if not avoided, could result in death or serious injury.

CAUTION indicates a hazardous situation which, if not avoided, could result in minor or moderate injury.

NOTICE is used to address practices not related to physical injury.

Dear Customer,

Your product has been manufactured in modern facilities and has passed strict quality control procedures.

To obtain the best performance, we request that you read through this user manual carefully, especially the safety instructions, before using your product and that you keep it for future reference. If this product is given to another consumer, please give them this manual for their reference.



IMPORTANT:

Save these instructions for the local electrical inspectors use.

The instructions will help you to operate the appliance properly and safely.

- Upon delivery, please check that the appliance is not damaged. If you note any transport damage, please contact the shipping company or company where you purchased the appliance immediately and do not connect and operate the appliance!
- When you pass on the appliance to another person, please provide all documents including original sales receipt which should show the date of purchasing. Warranty is not valid if the product is sold second hand.
- If you should decide not to use this appliance any longer (or decide to substitute an older model), before disposing of it, it is recommended that it be made inoperative in an appropriate manner in accordance with health and environmental protection regulations, ensuring in particular that all potentially hazardous parts be made harmless, especially in relation to children who could play with old appliances. Remove the door and the warming drawer before disposal to prevent entrapment.

TABLE OF CONTENTS

1 Safety Instructions - Read before use **6**

Basic safety instructions	6
Safety for children	9
Safety when working with electricity	10
Intended use.....	10
Disposal	11
Packaging material.....	11
Future transportation	11

2 Installation **12**

Installation and connection.....	12
----------------------------------	----

3 Preparation **23**

Tips for saving energy	23
Initial use.....	23
Time setting.....	23
First cleaning of the appliance.....	24
Initial heating	24

4 How to use the hob **25**

General information about cooking	25
Using the burners/plates.....	27
Using the hobs.....	28

5 How to operate the oven **33**

General information on baking, roasting and broiling	33
How to use the electric oven	33
Operating modes.....	34
Using the oven clock	35
Cooking times table.....	38
How to operate the broil.....	39

6 Maintenance and care **40**

General information	40
Cleaning the burner/plate	40
Cleaning the control panel	40
Cleaning the oven	40
Removing the oven door	41
Replacing the oven lamp.....	41

7 General information **43**

Overview.....	43
Technical specifications.....	44
Package contents.....	45

8 Troubleshooting **46**

9 WARRANTY STATEMENT FOR BLOMBERG ELECTRIC AND GAS RANGES **48**

1 Safety Instructions - Read before use



Basic safety instructions

- This appliance is not intended for use by persons (including children) with reduced physical, sensory or mental capabilities, or lack of experience and knowledge, unless they have been given supervision or instruction concerning use of appliance by a person responsible for their safety.
- Children should be supervised to ensure that they do not play with the appliance.
- Proper installation - Be sure your appliance is properly installed and grounded by a qualified technician
- Never use your appliance for warming or heating the room.
- Wear proper apparel - loose-fitting or hanging garments should never be worn while using the appliance.
- User servicing - Do not repair or replace any part of the appliance unless specifically recommended in the manual. All other servicing should be referred to a qualified technician.
- Use proper pan size - this appliance is equipped with one or more surface units of different size. Select utensils having flat bottoms large enough to cover the surface unit heating element. The use of undersized utensils will expose a portion of the heating element to direct contact and may result in ignition of clothing. Proper relationship of utensil to burner will also improve efficiency.
- Never leave surface units unattended at high heat settings - boilover causes smoking and greasy spillovers that may ignite.
- Protective liners- do not use aluminum foil to line oven bottoms, except as suggested in the manual. Improper installation of these liners may result in a risk of electric shock, or fire.
- Glazed cooking utensils - only certain types of glass, glass/ceramic, ceramic, earthenware, or other glazed utensils are suitable for range-top service without breaking due to the sudden change in temperature.
- Utensil handles should be turned inward and not extend over adjacent surface units - to reduce the risk of burns, ignition of flammable materials, and spillage due to unintentional contact with the utensil, the handle of a utensil should be

positioned so that it is turned inward, and does not extend over adjacent surface units.

- Use care when opening door- let hot air or steam escape before removing or replacing food.
- Placement of oven racks -always place oven racks in desired location while oven is cool. If rack must be moved while oven is hot, do not let potholder contact hot heating element in oven.
- Use only dry potholders- moist or damp potholders on hot surfaces may result in burns from steam. Do not let potholder touch hot heating elements. Do not use a towel or other bulky clothes.
- Do not cook on broken cook-top - if cook-top should break, cleaning solutions and spillovers may penetrate the broken cook-top and create a risk of electric shock. Contact a qualified technician immediately.
- **Clean cook-top with caution** - if a wet sponge or cloth is used to wipe spills on a hot cooking area, be careful to avoid steam burn. Some cleaners can produce noxious fumes if applied to a hot surface.
- **"Do not touch surface units or areas near units** - Surface units may be hot even though they are

dark in color. Areas near surface units may become hot enough to cause burns. During and after use, do not touch, or let clothing or other flammable materials contact surface units or areas near units until they have had sufficient time to cool. Among these areas are the cook-top and surfaces facing the cook-top."

- **"Do not touch heating elements or interior surfaces of oven** - Heating elements may be hot even though they are dark in color. Interior surfaces of an oven become hot enough to cause burns. During and after use, do not touch, or let clothing or other flammable materials contact heating elements or interior surfaces of oven until they have had sufficient time to cool. Other surfaces of the appliance may become hot enough to cause burns - among these surfaces are oven vent openings and surfaces near these openings, interior surfaces of the oven cavity, oven doors, and window"
- Never use when judgment or coordination is impaired by the use of alcohol and/or drugs.

- Do not operate the appliance if it is defective or shows any visible damage.
- Be careful when using alcoholic drinks in your dishes. Alcohol evaporates in high temperatures and may cause fire since it will catch fire when it gets in contact with hot surfaces.
- Do not heat closed food containers and glass jars. Pressure that may build-up in the jar can cause it to burst.
- Do not use the oven for a storage area. Items stored in an oven can ignite.
- Storage in or on Appliance-Flammable materials should not be stored in an oven or near surface units.
- **Fire risk!** Do not store flammable material in the oven and/or in the warming drawer.
- Keep appliance area clear and free from combustible materials, gasoline, and other flammable vapors.
- **Do not use water on grease fires.** Smother fire or flame or use dry chemical or foam type extinguisher.
- Do not use the oven to dry newspapers. If overheated, they can catch on fire.
- Do not leave paper products, cooking utensils or food in the oven when not in use.
- Do not leave empty pots or pans on plates that are switched on. They might get damaged.
- Since it may be hot, do not leave plastic or aluminum dishes on the surface of appliance. These kind of dishes should not be used to keep food either.
- Do not place baking trays, dishes or aluminium foil directly onto the bottom of the oven. The heat accumulation might damage the bottom of the oven.
- Keep all ventilation slots clear of obstructions.
- The manufacturer declines all liability for injury to persons or damage to property caused by incorrect or improper use of the appliance.
- Do not use the oven with front door glass removed or broken.
- Metallic objects such as knives, forks, spoons and lids should not be placed on the hob surface since they can get hot.
- The appliance is not intended to be operated by means of an external timer or separate remote-control system.
- Vapour pressure that build up due to the moisture on the hob surface or at the bottom of the

pot can cause the pot to move. Therefore, make sure that the oven surface and bottom of the pots are always dry.

- Hotplates are equipped with “Induction” technology. Your induction hob that provides both time and money savings must be used with pots suitable for induction cooking; otherwise hotplates will not operate.
- As induction hobs create a magnetic field, they may cause harmful impacts for people who use devices such as insulin pump or pacemaker.
- Use only hob guards designed by the manufacturer of the cooking appliance or indicated by the manufacturer of the appliance in the instructions for use as suitable or hob guards incorporated in the appliance. The use of inappropriate guards can cause accidents.
- Check that all controls on the appliance are switched off after use.
- **IMPORTANT:** Call the authorized service for installation of the appliance to be used. After this procedure, guarantee period will be started.

Safety for children



- **WARNING:** Stepping, leaning or sitting on the door or drawers of

this range can result in serious injuries and also cause damage to the range. Do not allow children to climb or play around the range. The weight of a child on an open door may cause the range to tip, resulting in serious burns or other injury.

- Accessible parts may be hot when the broil is in use. Young children should be kept away.
- Do not leave children alone - children should not be left alone or unattended in area where appliance is in use. They should never be allowed to sit or stand on any part of the appliance.
- Surface units may be hot even though they are dark in color. Areas near surface units may become hot enough to cause burns. During and after use, do not touch or let clothing or other flammable materials contact surface units until they have had sufficient time to cool. Among these areas are (identification of areas) for example, the cook-top and surfaces facing the cook-top.
- **WARNING:** Do not store items of interest to children in the cabinets above the range or on back guard of a range. Children climbing on the range to reach items could be seriously injured.

- The packaging materials will be dangerous for children. Keep the packaging materials away from children. Please dispose of all parts of the packaging according to environmental standards.
- **WARNING:** A child or adult can tip the range and be killed. Verify the anti-tip device has been properly installed to the floor or wall and that the rear foot of the range is engaged to bracket as shown in illustration instructions. Ensure the anti-tip device is re-engaged when the range is moved by ensuring the foot of the is engaged into the anti-tip device. Do not operate the range without the anti-tip device in place and engaged.

Safety when working with electricity

- Any work on electric equipment and systems may only be carried out by authorized qualified persons.
-  **WARNING:** Before installing, turn power OFF at the service panel. Lock service panel to prevent power from being turned ON accidentally.
-  **WARNING:** Personal injury or death from electrical shock may occur if the range is not in-

- stalled by a qualified installer or electrician.
- Any additions, changes or conversions required in order for this appliance to satisfactorily meet the application needs must be made by a qualified technician.
- In case of any damage, switch off the appliance and disconnect it from the main supply by removing the fuse or switching off the circuit breaker.
- Ensure that the fuse rating is correct.
- Do not operate the appliance barefooted.
- Never touch the appliance with wet hands or feet.
- Do not soak removable heating elements. Heating elements should never be immersed in water.

Intended use

- The appliance is designed for domestic use only. Commercial use is not admissible.
- This appliance should not be used for warming the plates under the broil, hanging towels and dish cloths on the handles, for drying and the space heating purposes.
- All openings in the wall behind the appliance and in the floor

under the appliance shall be sealed.

- This appliance is not intended to use at mobile homes, recreational vehicles.
- The manufacturer shall not be held liable for any damage caused by improper use or handling errors.
- The appliance can be used for defrosting, baking, roasting and broiling food.

Disposal

Packaging material



DANGER:

Risk of suffocation by the packaging materials!

Packing elements (i.e. plastic bags, polystyrene foam, nails, packing straps, etc.) should not be left around within easy reach of children, as these may cause serious injuries.

The packaging material and transport locks are made from materials that are not harmful to the environment. Please dispose of all parts of the packaging according to environmental standards. This is beneficial to the environment.



CAUTION:

If product will be given to someone for personal use or given to someone for second hand use, User manual, product labels, other related documents, mounting parts etc. should be given with product.

Electrical connection should be done according to User Manual.

Future transportation

Do not carry out cleaning or maintenance operations on the appliance without having previously disconnected it from the electric power supply.



NOTICE:

Do not place other items on the top of the appliance. The appliance must be transported upright.

Store the appliance's original box and transport the appliance in its original carton. Follow the guidance marks that are printed on the carton.



IMPORTANT:

Verify the general appearance of your equipment by identifying possible damage during the transportation.

To prevent the wire shelf and tray inside the oven from damaging the oven door, place a strip of cardboard onto the inside of the oven door that lines up with the position of the trays. Tape the oven door to the side walls.

If you do not have the original carton

Pack the appliance in bubble wrap or thick cardboard and tape it securely in order to prevent damage during transportation.



WARNING: This product can expose you to chemicals including Nickel (Metallic) which is known to the State of California to cause cancer. For more information go to

www.P65Warnings.ca.gov

Note: Nickel is a component in all stainless steel and some other metal components.

2 Installation

To ensure that critical air gaps are maintained under the appliance, we recommend that this appliance is mounted on a solid base and that the feet do not sink into any carpet or soft flooring.

The kitchen floor must be able to carry the weight of the appliance plus the additional weight of cookware and bake ware and food.

- If an appliance hood is to be fitted, refer to the manufacturer's instructions regarding fixing height.
- The appliance corresponds to device class 1, i.e. it may be placed with the rear and one side to kitchen walls, kitchen furniture or equipment of any size. The kitchen furniture or equipment on the other side may only be of the same size or smaller.
- Any kitchen furniture next to the appliance must be heat-resistant (212 °F min.).

Important notes to the consumer

Keep this manual for future reference.

- As when using any range generating heat, there are certain safety precautions you should follow. These are listed in the front of this manual. Read and follow carefully.
- Be sure your range is installed and grounded properly by a qualified installer or service technician.
- To eliminate the need to reach over the cooktop, cabinet storage space above the cooktop should be avoided.

Important notes to the installer

Read manual before installing the cooker.

Observe all governing codes and ordinances.

Be sure to leave these instructions with the consumer.

Be sure your range is installed and grounded properly by a qualified installer or service technician.

IMPORTANT:

Before installing the range in an area covered with linoleum or any other synthetic floor covering, make sure the floor covering can withstand heat at least 90°F (32.2°C) above room temperature without shrinking, warping or discoloring.

Do not install the range over carpeting unless you place an insulating pad or sheet of 1/44 inch (0.64cm) thick plywood between the unit and carpeting.

Installation and connection

IMPORTANT:

Do not install the appliance next to refrigerators or freezers. The heat emitted by the appliance will lead to an increased energy consumption of cooling appliances.

- For installation the appliance must be connected in accordance with all local electrical regulations.

CAUTION:

Unit is heavy and requires a least two persons or proper equipment to move.

NOTICE: Material damage!

Do not place other items on the top of the appliance. The appliance must be transported upright. The door and/or handle must not be used for lifting or moving the appliance. Take care not to touch the oven heating element also located at the top of the oven cavity, just behind the ridged area. It is recommended to wear gloves and long sleeves to protect hands and forearms from abrasion and potential scratches during the lifting process. It is also recommended to take off watches and jewelry and to wear work shoes during installation for foot protection. Remove the oven door for easier handling and installation.

- The appliance must be placed directly on the floor. It must not be placed onto a base or a pedestal.

Clearances & Dimensions

Dimensions that are shown in figures 1 and 1A must be used. Given dimensions provide minimum clearance. There needs to be a 30-inch minimum clearance between the top of the cooking surface and the bottom of unprotected wood or metal cabinets or a 24-inch minimum when bottom of wood or metal cabinets are protected by not less than a 1/4-inch flame retardant millboard covered with not less than

no. 29 msg sheet-steel, 0.015-inch stainless steel, 0.024-inch aluminum or 0.020-inch copper.

To eliminate the risk of burns or fire by reaching over heated surface units, cabinet storage space located above the surface units should be avoided. If cabinet storage is to be provided, the risk can be reduced by installing a range hood that projects horizontally a minimum of 5 inches beyond the bottom of the cabinets.

Figure 1

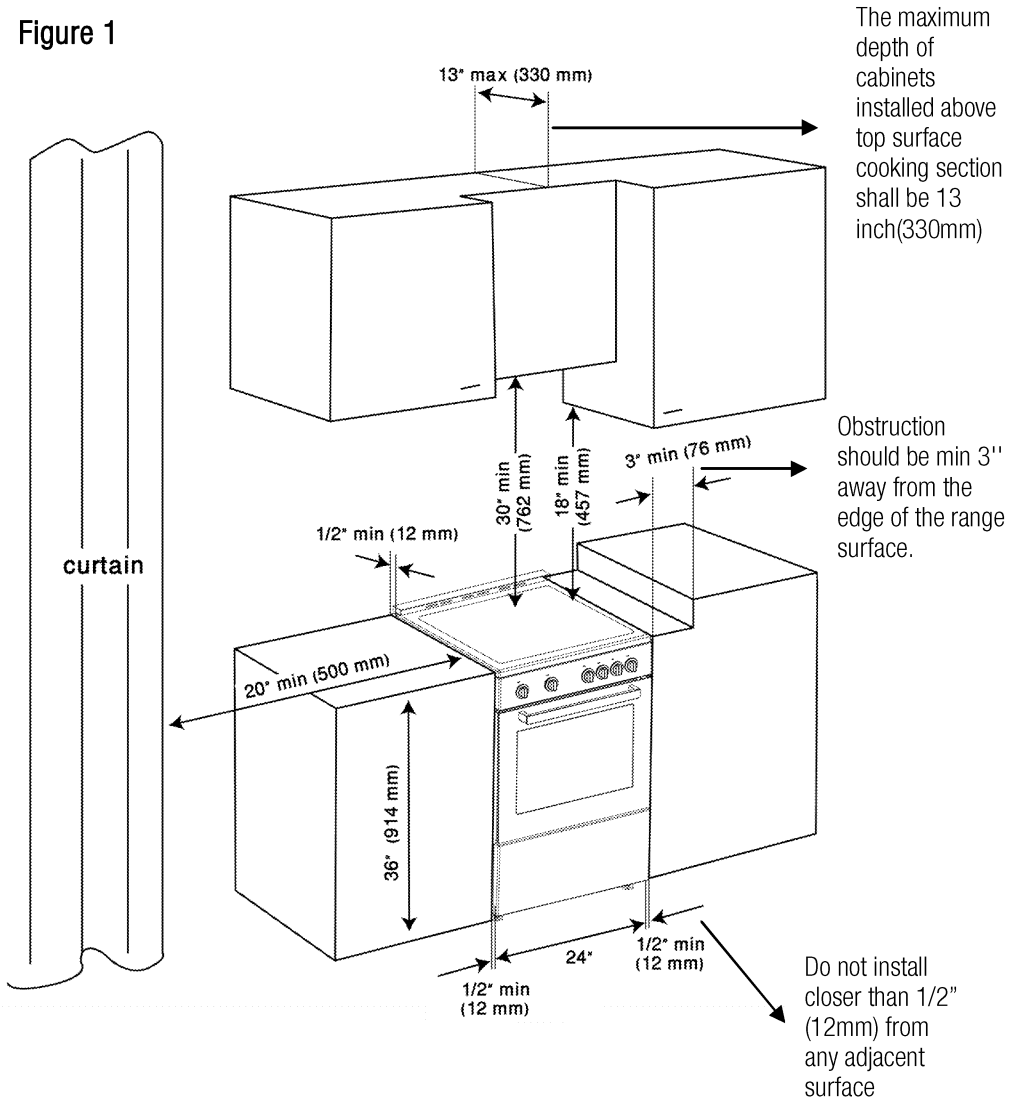
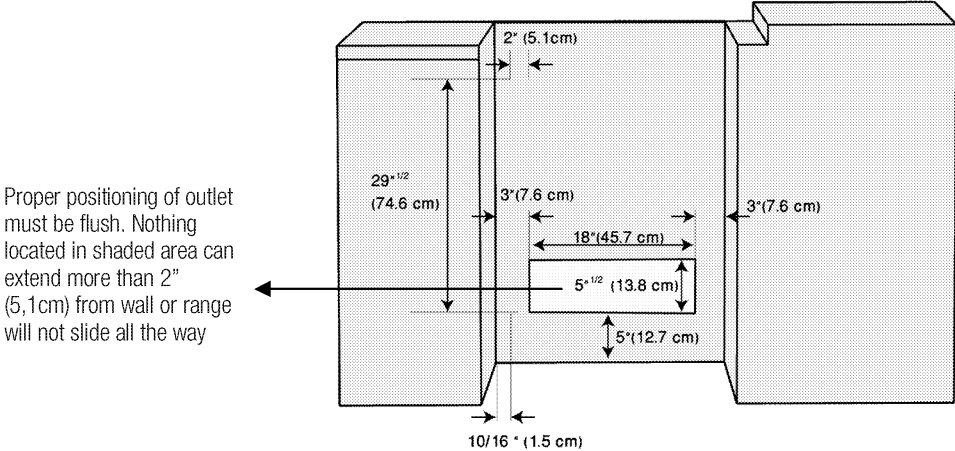
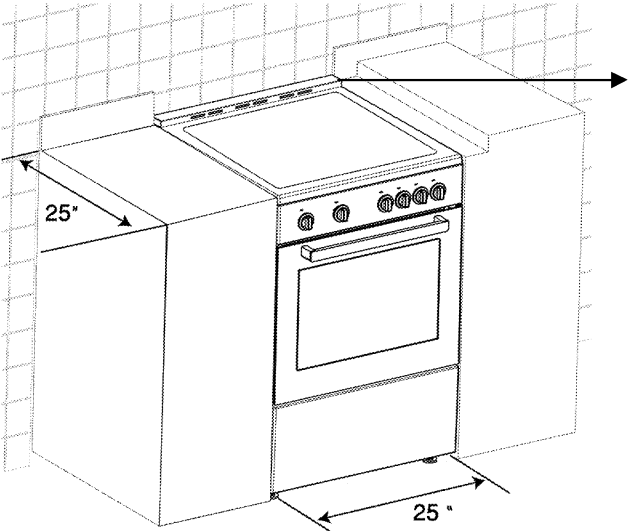

Figure 1A



Proper positioning of outlet must be flush. Nothing located in shaded area can extend more than 2" (5,1 cm) from wall or range will not slide all the way

Figure 1B



The island trim is supplied with your range. For the installation, please see "Package content" section on page 37.

Anti-Tip stability device installation instructions



WARNING:

All ranges can tip and injury to persons could result.

- A child or adult can tip the range and be killed.
- Install the anti-tip device packed with range to the structure wall of floor.
- Engage the range to the anti-tip bracket by sliding range so that the rear foot of range into the bracket as shown in figures.
- Re-Engage the anti-tip device if the range is moved.
- See installation instructions below.
- Failure to follow these instructions can result in death or serious burns to children or adults.

A package of anti-tip device is supplied with product. Anti-tip devices, screws, fixing plugs and anti-tip installation template is provided in this package.

Anti-tip brackets must be secured to both wall and floor and must be used for the both rear feet.

1. Place the back edge of the template against the wall behind the range.

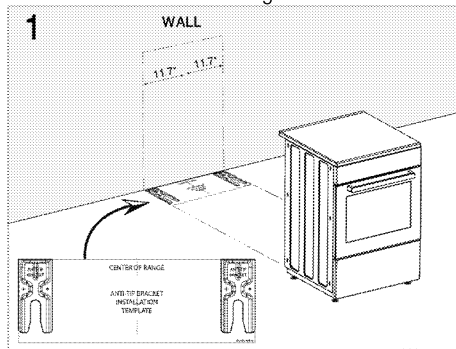

2. Center the template in the gap in where the range will be installed.
3. Place anti-tip brackets on the template and mark locations of the screw holes on the floor and wall (4 marks for 4 screws).

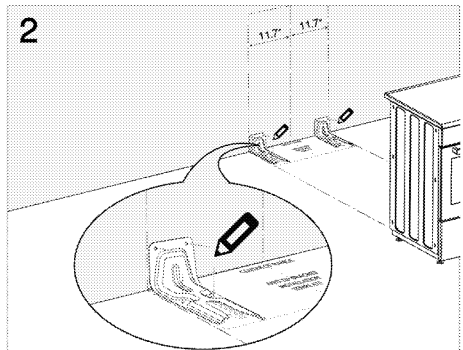

4. Remove the brackets and templates. Drill pilot holes on the marks in accordance with fixing plug and screw dimensions.
5. Screw and secure anti-tip brackets on the floor with screws.

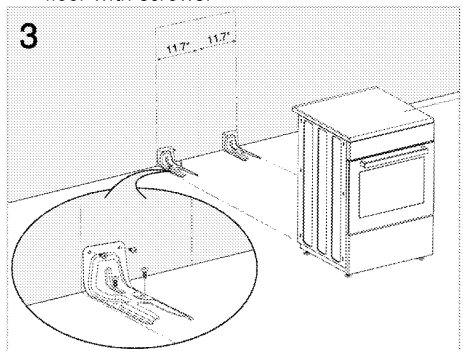

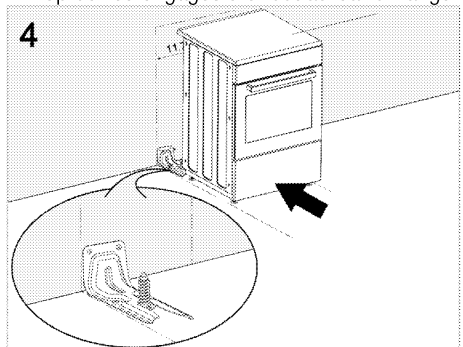

6. Please ensure the product is level by adjusting the four feet at the bottom by turning left or right and align level with the work top.
7. Slide range into place making sure the anti-tip device engages the foot at rear of range.



8. After installation cautiously grip the rear of the range to ensure the anti-tip bracket is engaging the rear foot of range.



 **WARNING: Tip Over Hazard**
A child or adult can tip the range and be killed. Connect anti-tip bracket to anti-tip hole at the back of the range. Reconnect the anti-tip bracket, if the range is moved. Failure to follow these instructions can result in death or serious burns to children and adults.

 **WARNING: Electrical shock hazard!**

- Use extreme caution when drilling holes into the wall or floor. There may be concealed electrical wires located behind the wall or under the floor.
- Identify the electrical circuits that could be affected by the installation of the Anti Tip Device, then turn off power to these circuits.

Failure to follow these instructions may result in electrical shock or other personal injury.

Connection to the main supply

 **WARNING**
Risk of electric shock! Before starting any work on the electrical installation, the electrical power to the range must be shut off while line connections are being made. Failure to follow these instructions can result in death, fire, or electrical shock.

 **IMPORTANT:**
Electrical installation should comply with national and local codes.

 **IMPORTANT:**
This appliance must be properly grounded to avoid shock hazard!
Our company shall not be held responsible for any damage caused by using the appliance without grounded receptacle. This range must be electrically grounded in accordance with local codes, or in their absence, with the National Electrical Code ANSI/NFPA No. 70-latest edition in United States. Installation should be made by a Licensed electrician.

Provide Electrical connection

Install the junction box under the cabinet and run 120/240 or 120/208 Volt, AC wire from the main circuit panel. DO NOT connect the wire to the circuit panel at this time.

Electrical requirements

This appliance must be supplied with the proper voltage and frequency and connected to an individual, properly grounded branch circuit, protected by a circuit breaker or fuse. A circuit breaker or fuse is required by your appliance. The circuit breaker or fuse amperage recommended for your appliance is 40A.

Observe all governing codes and local ordinances

A 3 wire or 4 wire single phase 120/240 or 120/208 Volt, 60 Hz AC only electrical supply is required on a separate circuit fused on both sides of the line (red and black wires). A time-delay fuse or circuit breaker is recommended. DO NOT fuse neutral (white wire).

NOTE: Wire sizes and connections must conform with the fuse size and rating of the appliance in accordance with the American National Electrical Code ANSI/ NFPA No. 70-latest edition.

 **WARNING**
Risk of electric shock, short circuit or fire by damage of the main power supply! The main power supply lead must not be clamped, bent or trapped or come into contact with hot parts of the appliance. If the main power cable is damaged, it must be replaced by a qualified electrician.

This range may be connected by means of permanent "hard wiring" (flexible armored or nonmetallic shielded copper or aluminum cable), or by means of a power supply cord kit. Only a power supply cord kit rated at 120/ 240 volts and 40 or 50 amperes terminating in tinned leads and marked for use with ranges shall be used. If a 50 Amper cord is used it must be marked for use with a 1 3/8 inches (35 mm) diameter opening. 15 EN

Cord must have either 3 or 4 conductors to match electric receptacle (Use copper or Aluminum Conductors).

WARNING
Risk of fire or electrical shock exists if an incorrect size appliance cord kit is used or the Installation manual or usage of strain relief/squeeze connector are disregarded

WARNING
Do not loosen the nuts which secure the factory-installed range wiring to the terminal block while connecting range. Electrical failure or loss of electrical connection may occur.

When installed where it is not permitted to ground through the neutral, a 4-conductor cord must be used or cable assembly. See manufacturer's instructions.

The main supply data must correspond to the data specified on the rating plate of the appliance. The rating plate is either seen when the door or the lower cover is opened.

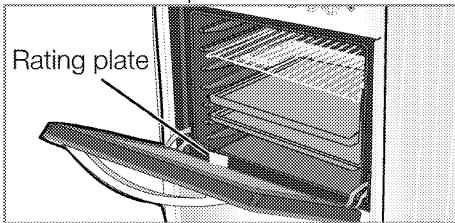

3 & 4 -wire electrical wall receptacle types & recommended mounting orientation on wall

Figure A illustrates 4-wire receptacle required for new branch circuit installation (1996 NEC) mobile homes, and recreational vehicles or where local codes do not allow grounding thru the neutral. Figure B illustrates 3-wire receptacle that is allowed in areas that allow grounding through neutral.

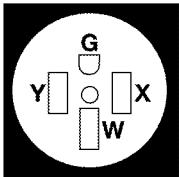

A) 4-wire wall receptacle (14-50R)

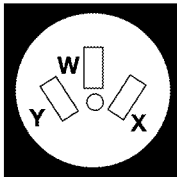

B) 3-wire wall receptacle (10-50R)

This range is manufactured with the neutral terminal connected to the frame of the range.

Use a 3-wire, UL listed, 40- or 50-amp power supply cord.

If local codes do not permit grounding through the neutral, use a 4-wire, UL listed power supply cord rated at 250 volts, 40- or 50-amps and investigated for use with ranges.

Access to Terminal Block

Loosen the screws on rear acces cover and take off the terminal block cover see Figure 4.

Figure 4

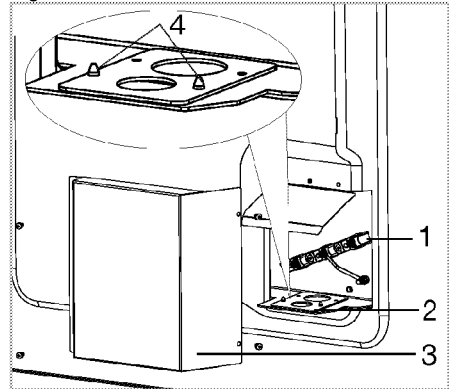

- 1 Terminal block
- 2 Power cord/conduit plate
- 3 Terminal block cover
- 4 Screws

After completing connections put terminal block cover to the original location and tighten the screws.

Power cord connections



WARNING

Risk of electric shock!

Frame grounded to neutral of appliance through a link. Grounding through the neutral conductor is prohibited for new branch-circuit installations (1996 NEC); mobile homes; and recreational vehicles, or in an area where local codes prohibit grounding through the neutral conductor. For installations where grounding through the neutral conductor is prohibited:

- a- Disconnect the link from the neutral;
- b- Use grounding terminal or lead to ground unit; and
- c- Connect neutral terminal or lead to branch circuit neutral in usual manner (when the appliance is to be connected by means of a cord kit, use 4-conductor cord or conduit for this purpose).



WARNING

Do not use an extension cord.



IMPORTANT:

Do not loosen the factory installed nut connections which secure the range wiring to terminal block. Electrical failure or loss of electrical connection may occur if these 3 nuts are loosened or removed.

Strain relief installation

Purchase a strain relief before installation.

1. Remove the terminal block cover on the back of the range) by removing the screws as shown in figure 4.

Do not discard screws.

2. Remove the power cord/conduit plate (part no 2) shown in figure 4, by removing the two screws that secure it to the range bracket. (Save screws for possible future use.)



IMPORTANT:

Retain this plate for future use in case the range is moved and re-wired.

3. Using the 1-3/8 in. diameter opening insert the strain relief and power cord through the opening and secure the strain relief as directed in the power cord instructions as shown in figure 5.



WARNING:

Do not install the power cord without a strain relief

Figure 5

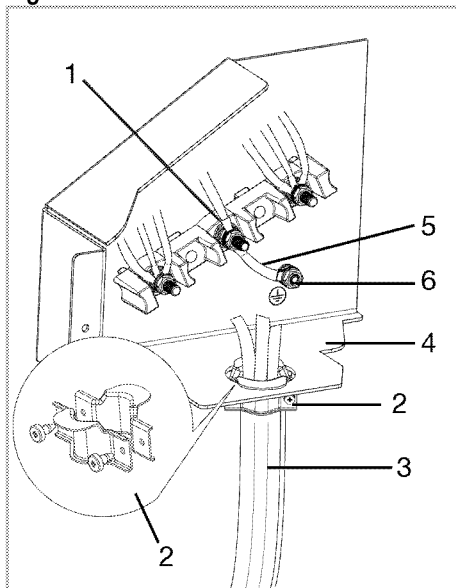

- 1 Terminal block
- 2 Strain relief
- 3 Power cord
- 4 Range bracket
- 5 Grounding wire
- 6 Grounding nut

Conduit installation

Purchase a squeeze connector matching the diameter of the conduit and assemble it in the hole. Insert the conduit through the squeeze connector and tighten. Allow enough slack to easily attach the wires to the terminal block. A Listed conduit connector may also be used for this purpose.

1. Remove the terminal block cover (on the back of the range) by removing the screws as shown in Figure 4. Do not discard screws.
2. Determine the size of conduit needed and if necessary remove the power cord/conduit plate (part no 4) or reverse the plate so that the proper size opening in power cord/conduit plate for your conduit is directly over the 1-3/8 in opening in the range bracket, shown in Figure 6. Secure the power cord/conduit plate using the same screws that were removed to take the plate off.
3. Secure the conduit to the power cord/conduit plate using a listed squeeze connector as shown in Figure 6.
4. See Figure.7 for 3 wire power connection and figure.8 for 4 wire connection.

Figure 6

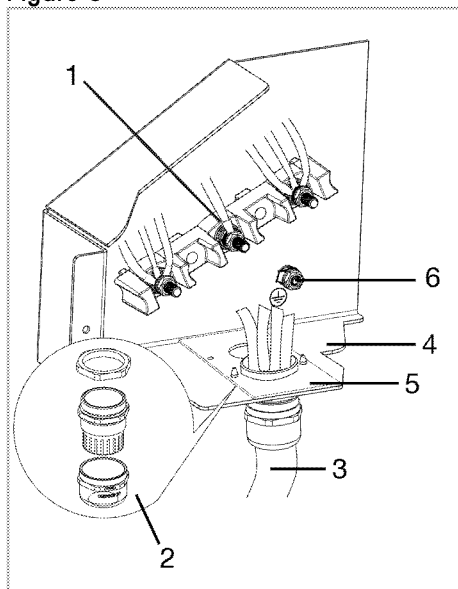

- 1 Terminal block
- 2 Squeeze connector
- 3 Conduit
- 4 Range bracket
- 5 Power cord/conduit plate
- 6 Grounding nut

Three wire connection:

The four-wire connection (below) is preferred, but where local codes and ordinances permit grounding through the neutral and where conversion to four-wire is impractical, the unit may be connected to the power supply via a three wire connection.

i **IMPORTANT:** Grounding (green) wire and the neutral wire of the power cord must be connected to the neutral terminal located in the center of the terminal block. The power leads must be connected to the left and right terminals of the terminal block.

1. Disconnect electrical power at breaker box.
2. Remove the terminal block cover to expose the terminal block.
3. Follow the manufacturer's installation instructions with the strain relief clamp and install.
4. Remove the top nut and washer from each terminal post.

i **IMPORTANT:** DO NOT remove the second nut/washer on each post. These must stay in place to anchor the internal wiring attached to the terminal block. Do not cut or remove grounding (green) wire. If the ground wire is removed for any reason a separated ground wire must be connected to the separate grounding nut attached to the range frame and to an adequate ground source.

5. Attach the neutral (white) wire to the center junction block terminal using one of the nut/washer parts.
6. Attach the Line 1 (black) wire to the right junction block terminal using one of the nut/washer parts.
7. Attach the Line 2 (red) wire to the left junction block terminal using one of the nut/washer parts.
8. Tighten all connections securely and put terminal block cover to the original location and tighten the screws.
9. Properly secure strain relief (see previous section).

i **IMPORTANT:** Make sure grounding (green) wire is secured to the frame via grounding nut.

Figure 7 – Three wire connection

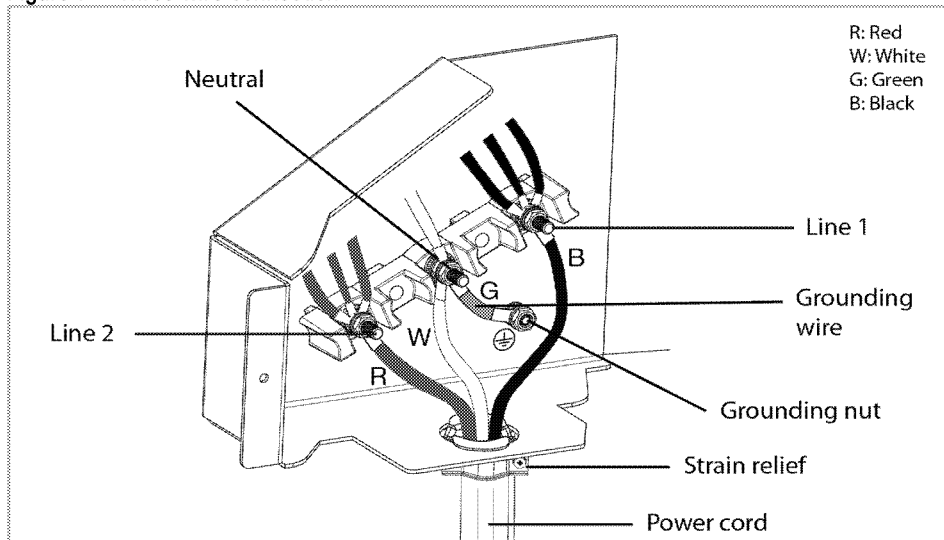

Four wire connection:



IMPORTANT:

The neutral wire of the supply circuit must be connected to the neutral terminal of the terminal block located in the center of the terminal block. The power leads must be connected to the left and right terminals of the terminal block. The grounding wire must be connected to the range bracket with nut and washer as shown in the figure 8 below.

1. Disconnect electrical power at breaker box.
2. Remove the terminal block cover to expose the terminal block.
3. Remove the top nut and washer from each post.



IMPORTANT:

DO NOT remove the second nut/washer on each post. These must stay in place to anchor the internal wiring attached to the terminal block.

4. Remove nut and washer on the ground connection from range bracket.
5. Remove nut and washer located at the center of the terminal block. Remove and discard the green grounding wire between center of terminal block and ground connection on the range bracket.
6. Attach the grounding (green) wire of the power supply cord to the ground connection on the range bracket using one of the nut/washers removed in step 4.
7. Attach the neutral (white) wire to the center terminal block using one of the nut/washer parts.
8. Attach the Line 1 (black) wire to the right terminal block using one of the nut/washers removed in step 3.
9. Attach the Line 2 (red) wire to the left terminal block using one of the nut/washer parts.
10. Properly secure strain relief/squeeze connector (see previous section).
11. Tighten all connections securely and put terminal block cover to the original location and tighten the screws.

Figure 8 - Four wire connection

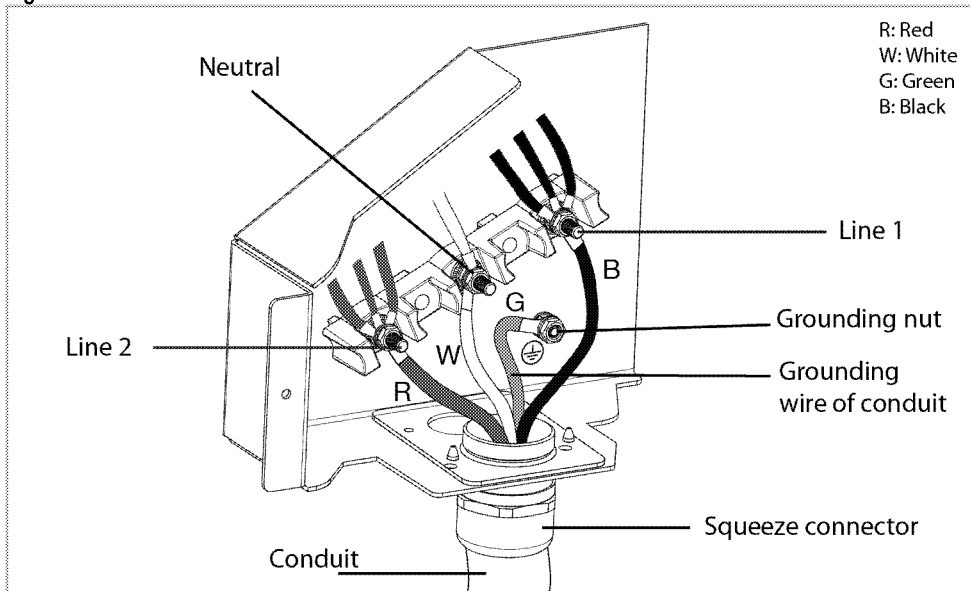

For products with cooling fan

The cooling fan cools both the built-in cabinet and the front of the product.



IMPORTANT:

Cooling fan continues to operate for about 20-30 minutes after the oven is switched off.

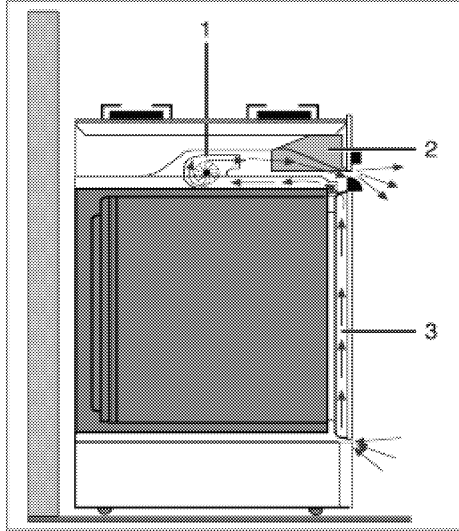

- 1 Cooling fan
- 2 Control panel
- 3 Door

3 Preparation

Tips for saving energy

The following information will help you to use your appliance in an ecological way, and to save energy:

- Use dark colored or enamel coated cookware in the oven since the heat transmission will be better.
- While cooking your dishes, perform a pre-heating operation if it is advised in the user manual or cooking instructions.
- Do not open the door of the oven frequently during cooking.
- Try to cook more than one dish in the oven at the same time whenever possible. You can cook by placing two cooking vessels onto the wire shelf.
- Defrost frozen dishes before cooking them.
- You can save energy by switching off your oven a few minutes before the end of the cooking time (The oven door should not be opened).
- Use pots/pans with cover for cooking. If there is no cover, energy consumption may increase 4 times.
- Select the burner which is suitable for the bottom size of the pot to be used. Always select the correct pot size for your dishes. Larger pots require more energy.
- Take care to use flat base saucepans while cooking on electrical cookers.
- Pots with an even and thick bottom provide better thermal conduction. You can save up to 1/3 of electricity.
- Pots and pans should match the size of plates. The bottom of the pot or pan should not be smaller than the plate.
- Keep plates and pan bottoms clean. Dirt will reduce the heat transmission between plate and pan bottoms.
- In case of longer cooking times, switch off the plate 5 to 10 minutes before the end of the cooking time. When you use the residual heat, you can save up to 20 % of electricity.

Initial use

Time setting



While making any adjustment, related symbols will flash on the display.

Press **+**/**-** keys to set the time of the day after the oven is energized for the first time.



For touch control models, touch  first and then use **+**/**-** to set the time of the day.

Confirm the setting by touching  symbol and wait for 4 seconds without touching any keys to confirm.

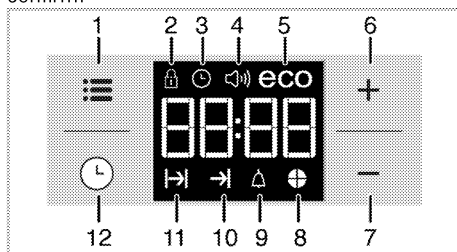

- 1 Adjustment key
- 2 Keylock symbol
- 3 Clock symbol
- 4 Alarm volume symbol
- 5 Eco mode symbol
- 6 Plus key
- 7 Minus key
- 8 Time pie symbol
- 9 Alarm symbol
- 10 End of Cooking Time symbol
- 11 Cooking Time symbol
- 12 Program key



If the initial time is not set, clock will run starting from **12:00** and  symbol will be displayed. The symbol will disappear once the time is set.



Current time settings are canceled in case of power failure. It needs to be readjusted.

First cleaning of the appliance



When removing appliance for cleaning and/ or service;
Disconnect AC power supply.
Carefully remove the range by pulling outward.
Range is heavy, use care in handling.



The surface might get damaged by some detergents or cleaning materials.
Do not use aggressive detergents, cleaning powders/creams or any sharp objects during cleaning.
Do not use harsh abrasive cleaners or sharp metal scrapers to clean the oven door glass since they can scratch the surface, which may result in shattering of the glass.

1. Remove all packaging materials.
2. Wipe the surfaces of the appliance with a damp cloth or sponge and dry with a cloth.

Initial heating



IMPORTANT:

Smoke and smell may emit for a couple of hours during the initial operation. This is quite normal. Ensure that the room is well ventilated to remove the smoke and smell. Avoid directly inhaling the smoke and the smell that emits.

Heat up the product for about 30 minutes and then switch it off. Thus, any production residues or layers will be burnt off and removed.



WARNING

Hot surfaces cause burns!
Product may be hot when it is in use. Never touch the hot burners, inner sections of the oven, heaters and etc. Keep children away.
Always use heat resistant oven gloves when putting in or removing dishes into/from the hot oven.

Electric oven

1. Take all baking trays and racks from the oven.
2. Close the oven door.
3. Select top and bottom heat with the function knob.
4. Select the highest temperature with the thermostat knob; see How to use the electric oven.
5. Heat approximately 30 minutes.
6. Switch off oven.

Broil



1. Take all baking trays and wire shelf from the oven.
2. Close oven door.
3. Select highest power of the broil.
3. Heat approximately 30 minutes.
4. Switch off broil.



Smoke and smell may emit for a couple of hours during the initial operation. This is quite normal. Ensure that the room is well ventilated to remove the smoke and smell. Avoid directly inhaling the smoke and the smell that emits.

4 How to use the hob

General information about cooking

	DANGER Risk of fire over by overheated oil! When you heat oil, do not leave it unattended.
	WARNING Do not use water on grease fires. Never pick up a flaming pan. Turn the controls off. Smother a flaming pan on a surface unit by covering the pan completely with a well-fitting lid or a fire blanket, cookie sheet or flat tray. Use a multi-purpose dry chemical or foam-type fire extinguisher.
	WARNING Do not place or store items that can melt or catch fire on the glass cook top, even when it is not being used. If the cook top is inadvertently turned on, they may ignite. Heat from the cook top or oven vent after it is turned off may cause them to ignite also.

- Always position pans centrally over the heating element. When transferring pans from one heating element to another always lift the pans do not slide them.
- Before frying foods, always dry them well and gently place into the hot oil. Ensure complete thawing of frozen foods before frying.
- Do not cover the vessel you use when heating oil.
- Place the pans and saucepans in a manner so that their handles are not over the hob to prevent heating of the handles. Do not place unbalanced and easily tilting vessels on the hob.
- Do not place empty vessels and saucepans on cooking zones that are switched on. They might get damaged.
- Operating a cooking zone without a vessel or saucepan on it will cause damage to the product. Turn off the cooking zones after the cooking is complete.
- As the surface of the product can be hot, do not put plastic and aluminum vessels on it.

Clean any melted such materials on the surface immediately.

Such vessels should not be used to keep foods either.

- Use flat bottomed saucepans or vessels only.
- Put appropriate amount of food in saucepans and pans. Thus, you will not have to make any unnecessary cleaning by preventing the dishes from overflowing.
Do not put covers of saucepans or pans on cooking zones.
- Place the saucepans in a manner so that they are centered on the cooking zone. When you want to move the saucepan onto another cooking zone, lift and place it onto the cooking zone you want instead of sliding it.

	WARNING Never leave surface units unattended at high heat settings. Boil over causes smoking and greasy spillovers that may ignite.
---	---

- Make sure reflector pans or drip bowls are in place. Absence of these pans or bowls during cooking may subject wiring or components underneath to damage.

Tips for glass ceramic plate

- The glass ceramic surface is heat-resistant and insensitive to large temperature deviations.
- Do not use the glass ceramic plate for keeping objects or as cutting surface.

	WARNING Do not cook popcorn in prepackaged aluminum containers on the cook top. They could leave aluminum marks that cannot be removed completely.
---	--

- Use pot and pans with ground bottoms. Sharp edges cause scratches on the surface.
- Do not use aluminum pots and pans. Aluminum damages the glass ceramic surface.



WARNING

Glazed cooking utensils - only certain types of glass, glass/ceramic, ceramic, earthenware, or other glazed utensils are suitable for range-top service without breaking due to the sudden change in temperature.

- For foods containing sugar in any form, clean up all spills and soils as soon as possible. Allow the cook-top to cool down slightly. Then, while wearing oven mitts, remove the spills while the surface is still warm. If sugary spills are allowed to cool down, they can adhere to the cook-top and can cause pitting and permanent marks.



WARNING

Use pot and pans with ground bottoms. Sharp edges cause scratches on the surface.



WARNING

Avoid scratching the glass cook top. The cook top can be scratched with items such as knives, sharp instruments, rings or other jewelry and rivets on clothing.



WARNING

If a wet sponge or cloth is used to wipe spills on a hot cooking area, be careful to avoid steam burn. Some cleaners can produce noxious fumes if applied to a hot surface. Utensil handles should be turned inward and not extend over adjacent Face units. To reduce the risk of burns, ignition of flammable materials, and spillage due to unintentional contact with the utensil, the handle of a utensil should be positioned so that it is turned inward, and does not extend over adjacent surface units.



ANGER

Tipping of pan

Make sure that the handles of cookware do not stick out over the edge of the appliance, to avoid them being knocked over by accident. This also makes it more difficult for children to reach the cooking pans.

- Ensure handles of pans cannot accidentally be caught or knocked and do not get hot by adjacent heating zones. Avoid pans that are unstable and easily tipped. Pans that are too

heavy to move easily when filled can also be a hazard.



WARNING

Do not store items of interest to children in cabinets above a range or on the back guard of a range - children climbing on the range to reach items could be seriously injured.

Saucepan selection

- Glass ceramic surface is heatproof and is not affected by big temperature differences.
- Do not use the glass ceramic surface as a place of storage or as a cutting board.
- Use only the saucepans and pans with machined bottoms. Sharp edges create scratches on the surface.

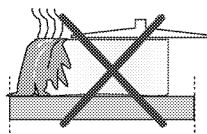

Spills may damage the glass ceramic surface and cause fire.

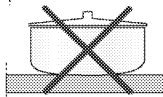

Do not use vessels with concave or convex bottoms.

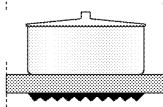

Use only the saucepans and pans with flat bottoms. They ensure easier heat transfer.

For induction hobs, use only vessels suitable for induction cooking.

Saucepan test

Use following methods to test whether your saucepan is compatible with the induction hob or not.

- Your saucepan is compatible if its bottom holds magnet.
- Your saucepan is compatible if "L" does not flash when you place your saucepan on cooking zone and start the hob.

You can use steel, teflon or aluminium saucepans with special magnetic bottom that contains labels or warnings indicating that the saucepan is compatible with induction cooking. Glass and ceramic vessels, pots and the stainless steel vessels with non-magnetic aluminium bottom should not be used.

Saucepan recognition-focusing system

In induction cooking, only the area covered by the vessel on the relevant cooking zone is energised. The vessel's bottom is recognised by the system and only this area is heated automatically. Cooking stops if the cooking vessel is lifted from the cooking zone during cooking. Selected cooking zone and "L" symbol flashes alternately.

Safe use

Do not select high heating levels when you will use a non-sticking (teflon) saucepan with no oil or with very little oil.

Do not put metal items such as forks, knives or saucepan covers onto your hob since they can get heated.

Never use aluminium folio for cooking. Never place food items wrapped with aluminium folio onto the cooking zone.

 If there is an oven under your hob and if it is running, sensors of the hob can decrease the cooking level or turn off the oven.

 When the hob is running, keep items with magnetic properties such as credit cards or cassettes away from the hob.

Selecting cooking zone suitable to the vessel

The cooking zones are, until a certain limit, automatically adapted to the diameter of the pan. However the bottom of this pan must have a minimum of diameter according to the corresponding cooking zone.

To obtain the best efficiency of your hob, please place the pan well in the centre of the cooking zone.

Large cooking zone	Normal cooking zone	Small cooking zone
10 inches (260 mm)	9 inches (210 mm)	6 inches (145 mm)
<ul style="list-style-type: none"> Automatically fits to the saucepan. Distributes the power ideally. Provides perfect heat distribution. Used to cook dishes such as large crepes or large fishes rare or very rare. 	<ul style="list-style-type: none"> Automatically fits to the saucepan. Distributes the power ideally. Provides perfect heat distribution. Used for all kinds of cookings. 	<ul style="list-style-type: none"> Used for slow cookings (sauces, creams) Used to prepare small portions or portions based on number of persons.

Using the burners/plates

 **DANGER:**
Avoid scratching or impacting glass doors, cook tops or control panels. Doing so may lead to glass breakage. Do not cook on a product with broken glass. Shock, fire or cuts may occur.

Do not let any objects fall onto the plate. Even small objects (e.g. salt shaker) may damage the burner/ plate.

 **DANGER:**
Do not use glass surface with cracks. Water may enter into the cracks and cause a short circuit.

 **DANGER:**
If the surface is damaged in any way (e. g. visible cracks), switch off the device immediately to reduce the risk of an electric shock.
If cooktop should break, cleaning solutions and spillovers may penetrate the broken cooktop and create a risk of electric shock. Contact a qualified technician immediately.

Using the hobs



DANGER

Broken glass!

Do not let any objects fall onto the hob. Even small objects (e.g. salt shaker) may damage the hob.

Do not use glass ceramic hobs with cracks. Water may enter into the cracks and cause a short circuit.

If the surface is damaged in any way (e. g. visible cracks), switch off the device immediately to reduce the risk of an electric shock.



Graphics and figures are for informational purposes only. Actual displays and functions may vary according to the model of your hob.

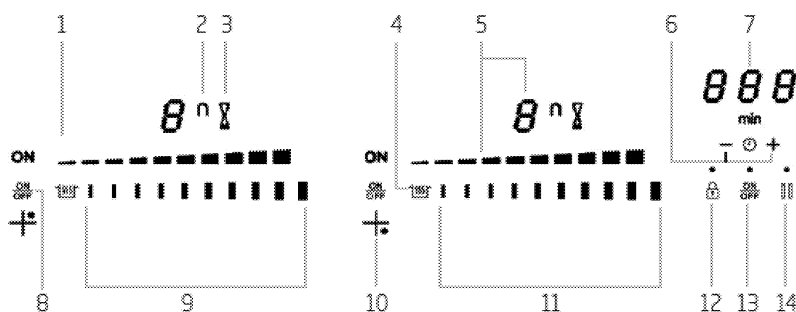

- | | | | |
|---|---------------------------|----|--|
| 1 | Cooking zone On displays | 9 | Power selection zone "Slider" (rear zone) |
| 2 | Bridge display | 10 | Localization information from the cooking zone |
| 3 | Timer display | 11 | Power selection zone "Slider" (front zone) |
| 4 | Keep warm key | 12 | Locking key |
| 5 | Power display | 13 | Main On/Off key |
| 6 | Timer keys | 14 | Pause/Recall key |
| 7 | Timer display | | |
| 8 | Cooking zone "On/Off" key | | |

Display	Designation	Description
0	Zero	The heating zone is activated.
1...9	Booster level	Selection of the cooking level.
U	No pan detection	No pan or inadequate pan.
A	Heat accelerator	Automatic cooking.
E	Error message	Electronic failure.
H	Residual heat	The heating zone is hot.
P	Power	The Power is activated.
.. 11	Super Power	The Super power is activated.
	Keep warm	Maintain automatically of 107.6, 158 or 201.2°F
	Stop&Go	The hob is in pause.

Sensitive touch

Your ceramic hob is equipped with electronic controls with sensitive touch keys. When your finger presses the key, the corresponding command is activated. This activation is validated by a control light, a letter or a number in the display and/or a “beep” sound. In the case of a general use press only one key at the same time.

Power selection zone “SLIDER” and timer setting zone

To select the power with the slider, slide your finger on the “SLIDER” zone. You can already have a direct access if you put your finger directly on the chosen level.

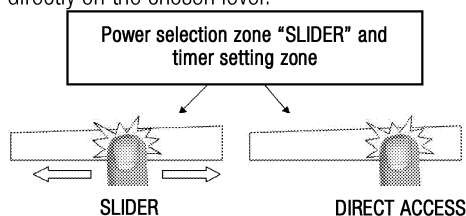

Starting-up

Start up / switch off the hob:

Action	Control panel	Display
To start	press [main On/Off] key	[0]
To stop	press [main On/Off] key	nothing

Start up / switch off a heating zone:

Action	Control panel	Display
Switch on cooking zone	Press cooking zone “On/Off” key	[ON]
To set (adjust the power)	slide on the “SLIDER” to the right or to the left	[1] to [P]
To stop	slide to [0] on “SLIDER”	[0] or [H]

If no action is made within 20 second the electronics returns in waiting position.

Residual heat indication

After the switch off of a heating zone or the complete stop of the hob, the heating zones are still hot and indicates [H] on the display. The symbol [H] disappears when the heating zones may be touched without danger. As far as the residual heat indicators are on light, don't touch the heating zones and don't put any heat sensitive object on them. There are risks of burn and fire.

Booster and Double Booster function

Booster [P] and Double Booster [. 11] grant a boost of Power to the selected heating zone. If this function is activated the heating zones work during 10 minutes with an ultra high Power. This is foreseen for example to heat up rapidly big quantities of water, like nuddles

Start up / Stop the Booster:

Action	Control panel	Display
Switch on cooking zone	Press cooking zone “On/Off” key	[ON]
Start up the Booster	Slide to the end of the “SLIDER” or press directly on the end of the “SLIDER”	[P]
Stop the Booster	Slide on the “SLIDER”	[9] to [0]

Start up / Stop Double Booster

Action	Control panel	Display
Switch on cooking zone	Press cooking zone “On/Off” key	[ON]
Start up the Booster	Or press directly on the end of the “SLIDER”	[P]
Start up Double Booster	Re-press key [P]	[. 11 and P]
Stop the Double Booster	Slide on the “SLIDER”	[P] to [0]
Stop Booster	Slide on the “SLIDER”	[9] to [0]

Power management:

The hole cooking hob is equipped with a maximum of Power. When the Power function is activated, and in order to exceed the maximum Booster, the electronic system orders to reduce automatically the power level of an other heating zone. The display is blinking on [9] during a few seconds and then shows the maximum of power allowed:

Heating zone selected	The other heating zone: (example: Booster level 9)	Heating zone selected
[P] is displayed	[9] goes to [6] or [8] depending the type of zone	[P] is displayed

Timer

The timer is able to be used simultaneous with all heating zones and this with different time settings (from 0 to 999 minutes) for each heating zone.

Setting and modification of the cooking time:

Action	Control panel	Display
Switch on cooking zone	Press cooking zone "On/Off" key	[ON]
Select the power level	Slide on the "SLIDER"	[1] to [P]
Select the Timer	Press simultaneously key [-] and [+] from the timer until the desired display is on	Timer display on
Decrease the time	Press key [-] from the timer	[60] to 59, 58...
Increase the time	Press key [+] from the timer	Time increase

After a few seconds, the [min] display stops with blinking.

The time is confirmed and the timer starts.

To stop the cooking time:

Action	Control panel	Display
Select the Timer	Press simultaneously key [-] and [+] from the timer until the desired display is on	Timer display on
Stop the time	Press key [-] from the timer	[000]

If several timers are activated, repeat the process.

Egg timer function:

Egg timer is an independent function. It stops as soon as a heating zone starts up. If the egg timer is on and the hob is switched off, the timer continues until time runs out.

Action	Control panel	Display
Activate the hob	Press [main On/Off] key	[0]
Select the Timer	Press simultaneously key [-] and [+] from the timer	[000]
Decrease the time	Press key [-] from the timer	[60] to 59, 58...
Increase the time	Press key [+] from the timer	Time increase

After a few seconds, the [min] display stops with blinking.

The time is confirmed and the timer starts.

Automatic stop at the end of the cooking time:

As soon as the selected cooking time is finished the timer displays blinking [000] and a sound rings. To stop the sound and the blinking, press the key [-] and [+].

Automatic cooking

All the cooking zones are equipped with an automatic cooking device. The cooking zone starts at full power during a certain time, and then reduces automatically its power on the pre-selected level.

Start-up:

Action	Control panel	Display
Switch on cooking zone	Press cooking zone "On/Off" key	[ON]
Power level selection (for example « 7 »)	Slide on the "SLIDER" to [7] and stay 3s	[7] is blinking with [A]

Switching off the automatic cooking:

Heating zone selected	The other heating zone: (example: Booster level 9)	Heating zone selected
Power level selection	Slide on the "SLIDER"	[0] to [9]

Stop&Go function

This function brakes all the hob's cooking activity temporarily and allows restarting with the same settings.

Start up/stop the pause function:

Action	Control panel	Display
Engage pause	Press [II]	[II] and control light on
Stop the pause	Press [II] Press on the animated "slider"	"Slider" animated previous settings

Recall Function

After switching off the hob (press main On/Off key), it is possible to recall the last settings.

- cooking stages of all cooking zones (Booster)
- minutes and seconds of programmed cooking zone-related timers
- Keep warm function

The recall procedure is following:

- Press [main On/Off] key
- Then press [II] before the light stops blinking.

The previous settings are again active.

"Keep warm" Function

This function allows the reach and automatically maintains at the temperature of 107.6, 158 or 201.2°F.

This will avoid liquids overflowing and fast burning at the bottom of the pan.

To engage, to start the function « Keep warm »:

Action	Control panel	Display
Switch on cooking zone	Press cooking zone "On/Off" key	[ON]
107.6°F to engage	Press on key [Keep warm]	
158°F to engage	Press and hold key [Keep warm] 2s	
201.2°F to engage	Press and hold key [Keep warm] 4s	
To stop	Slide on the "SLIDER" or press key [Keep warm] until [0]	[0] to [9]

The maximum duration of keeping warm is 2 hours.

Control panel locking

To avoid modification of the setting of the cooking zones , in particular during cleaning, the control panel can be locked (with exception to the main On/Off key).

Action	Control panel	Display
Locking the hob	Press during 6s	locking light on
Unlock the hob	Press during 6s	locking light off



Examples of cooking power setting

the values below are indicative

1 to 2	Melting Reheating	Sauces, butter, chocolate, gelatine Dishes prepared beforehand
2 to 3	Simmering Defrosting	Rice, pudding, sugar syrup Dried vegetables, fish, frozen products
3 to 4	Steam	Vegetables, fish, meat
4 to 5	Water	Steamed potatoes, soups, pasta, fresh vegetables
6 to 7	Medium cooking Simmering	Meat, lever, eggs, sausages Goulash, roulade, tripe
7 to 8	Cooking	Potatoes, fritters, wafers
9	Frying, roosting Boiling water	Steaks, omelettes, fried dishes Water
P and .. 11	Frying, roosting Boiling water	scallops, steaks Boiling significant quantities of water

5 How to operate the oven

General information on baking, roasting and broiling

	WARNING Hot surfaces cause burns! Product may be hot when it is in use. Never touch the hot burners, inner sections of the oven, heaters and etc. Keep children away. Always use heat resistant oven gloves when putting in or removing dishes into/from the hot oven.
	DANGER: Be careful when opening the oven door as steam may escape. Exiting steam can scald your hands, face and/or eyes.

Tips for baking

- Use non-sticky coated appropriate metal plates or aluminum vessels or heat-resistant silicone moulds.
- Make best use of the space on the rack.
- Place the baking mould in the middle of the shelf.
- Select the correct rack position before turning the oven or Broil on. Do not change the rack position when the oven is hot.
- Always place oven racks in desired location while oven is cool. If rack must be moved while oven is hot, do not let potholder contact hot heating element in oven.
- Keep the oven door closed.

Tips for roasting

- Seasoning with lemon juice and black pepper will improve the cooking performance when cooking a whole chicken, turkey or a large piece of meat.
- Meat with bones takes about 15 to 30 minutes longer before it is cooked than a roast of the same size without bones.
- You should calculate about 4 to 5 minutes cooking time per centimeter height of the meat.
- Let meat rest in the oven for about 10 minutes after the cooking time. The juice is better distributed all over the roast and does not run out when the meat is cut.



- Fish in a fire-resistant dish should be placed on the rack at the medium or lower level.

Tips for broiling

Broiling is ideal for cooking meat, fish and poultry and will achieve a nice brown surface without it drying out to much. Flat pieces, meat skewers and sausages are particularly suited for broiling as are vegetables with a high water content such as tomatoes and onions.

- Distribute the pieces to be broiled on the wire shelf.
- If the broiling is on the wire shelf, locate a dripping pan under it in order to collect the fat.
- Add some water in dripping pan for easy cleaning.

How to use the electric oven

	Food Poisoning Hazard Do not let food sit in oven more than one hour before or after cooking. Doing so can result in food poisoning or sickness.
	WARNING Never cover any slots, holes or passages in the oven bottom or cover an entire rack with materials such as aluminium foil. Doing so blocks airflow through the oven and may cause carbon monoxide poisoning. Aluminium foil linings may also trap heat, causing a fire hazard.

Select temperature and operating mode

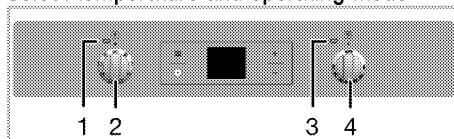

- 1 Function lamp
- 2 Function knob
- 3 Thermostat lamp
- 4 Thermostat knob

The operating modes of the electric oven are selected with the function knob. The temperature is adjusted with the thermostat knob. All oven functions are turned off by turning the relevant knob to off (upper) position.

1. Set thermostat knob to the desired temperature.
 2. Set function knob to the required operating mode.
- » The oven heats up to the adjusted temperature and maintains it. During heating, temperature lamp stays on.

Switch off electric oven

Turn function knob and thermostat knob to off position (top).

Rack positions (For models with wire shelf)

It is important to place the wire shelf onto the side rack correctly. Wire shelf must be inserted between the side racks as illustrated in the figure. Do not let the wire shelf stand against the rear wall of the oven. Slide your wire shelf to the front section of the rack and settle it with the help of the door in order to obtain a good broil performance.

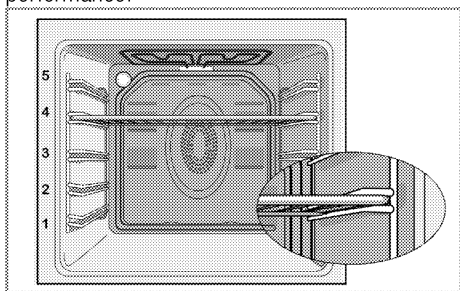

Operating modes

The order of operating modes shown here may be different from the arrangement on your product.

Top and bottom heating



Top and bottom heating are in operation. Food is heated simultaneously from the top and bottom. For example, it is suitable for cakes, pastries, or cakes and casseroles in baking moulds. Cook with one tray only.

Bottom heating



Only bottom heating is in operation. It is suitable for pizza and for subsequent browning of food from the bottom.

Fan supported bottom/top heating



Top heating, bottom heating plus fan (in the rear wall) are in operation. Hot air is evenly distributed throughout the oven rapidly by means of the fan. Cook with one tray only.

Operating with fan



The oven is not heated. Only the fan (in the rear wall) is in operation. Suitable for thawing frozen granular food slowly at room temperature and cooling down the cooked food.

Fan Heating



Warm air heated by the rear heater is evenly distributed throughout the oven rapidly by means of the fan. It is suitable for cooking your meals in different rack levels and preheating is not required in most cases. Suitable for cooking with multi trays.

"3D" function



Top heating, bottom heating and fan assisted heating (in the rear wall) are in operation. Food is cooked evenly and quickly all around. Cook with one tray only.

Broil



Large broil at the ceiling of the oven is in operation. It is suitable for broiling large amount of meat.

- Put big or medium-sized portions in correct rack position under the broil heater for broiling.
- Set the temperature to maximum level.
- Turn the food after half of the broiling time.

Broil with convection air





Broiling effect is not as strong as in Full Broil

- Put small or medium-sized portions in correct shelf position under the broil heater for broiling.
- Set the desired temperature.
- Turn the food after half of the broiling time.

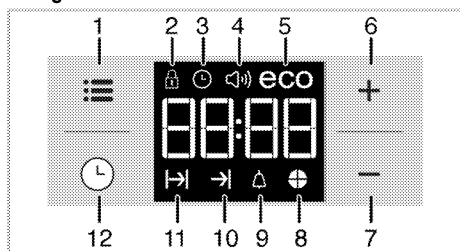
Using the oven clock



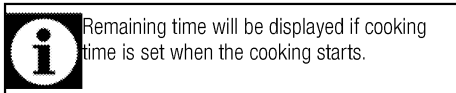

- 1 Adjustment key
- 2 Keylock symbol
- 3 Clock symbol
- 4 Alarm volume symbol
- 5 Eco mode symbol
- 6 Plus key
- 7 Minus key
- 8 Time pie symbol
- 9 Alarm symbol
- 10 End of Cooking Time symbol
- 11 Cooking Time symbol
- 12 Program key

	Maximum time that can be set for end of cooking is 5 hours 59 minutes. Program will be cancelled in case of power failure. You must reprogram the oven.
	While making any setting, related symbols will flash on the display. You must wait for a short time for the settings to take effect.
	If no cooking setting is made, time of the day cannot be set.



Cooking by setting the cooking time;





You can set the oven so that it will stop at the end of the specified time by setting the cooking time on the timer.



1. Select the function for cooking.
2. Touch  until  symbol appears on display for cooking time.
3. Set the cooking time with **+** / **-** keys.
» » After the cooking time is set,  symbol and the time slice will appear on display continuously.
4. Place the dish into the oven and set the temperature with temperature knob. Cooking will start.

» Cooking time starts to count down on display when cooking starts and all parts of time slice symbol is lit. The set cooking time is divided into 4 equal parts and when the time of each parts ends, the symbol of that parts turns off. So you can understand the ratio of remaining cooking time to total cooking time easily.

Setting the the end of cooking time to a later time; (This feature is optional. It may not exist on your product.)

After setting the cooking time on the timer, you can set the end of cooking time to a later time.

1. Select the function for cooking.
2. Touch  until  symbol appears on display for cooking time.
3. Set the cooking time with **+** / **-** keys.
» » Once the Cooking Time is set,  symbol will appear on display continuously.
4. Touch  until  symbol appears on display for the end of cooking time.
5. Press **+** / **-** keys to set the end of cooking time.

» After the cooking time is set,  symbol plus  symbol and the time slice will appear on display continuously. Once the cooking starts,  symbol disappears.

6. Place the dish into the oven and set the temperature with temperature knob. Cooking will start.

» Oven timer calculates the startup time by deducting the cooking time from the end of

cooking time you have set. Selected operating mode is activated when the startup time of cooking has come and the oven is heated up to the set temperature. It maintains this temperature until the end of cooking time.





» Cooking time starts to count down on display when cooking starts and all parts of time slice symbol is lit. The set cooking time is divided into 4 equal parts and when the time of each parts ends, the symbol of that parts turns off. So you can understand the ratio of remaining cooking time to total cooking time easily.

7. After the cooking process is completed, "End" appears on the displayed and the timer gives an audio warning.
8. Audio warning sounds for 2 minutes. To stop the audio warning, just press any key. Audio warning will be silenced and current time will be displayed.

 If you press any key at the end of the audio warning, the oven will restart operating. Turn the temperature knob and function knob to "0" (off) position to switch off the oven in order to prevent re-operation of the oven at the end of warning.



Activating the keylock

You can prevent oven from being intervened with by activating the key lock function.

1. Touch  until  symbol appears on display.
» "OFF" will appear on the display.
2. Press  to activate the key lock.
» Once the key lock is activated, "On" appears on the display and the  symbol remains lit.

 Oven keys are not functional when the key lock is activated. Key lock will not be cancelled in case of power failure.

To deactivate the keylock

1. Touch  until  symbol appears on display.
» "On" will appear on the display.
2. Disable the key lock by pressing the  key.
» "OFF" will be displayed once the keylock is deactivated.

Setting the alarm clock

You can use the timer of the product for any warning or reminder apart from the cooking program.



The alarm clock has no influence on the functions of the oven. It is only used as a warning. For example, this is useful when you want to turn food in the oven at a certain point of time. Timer will give an audio warning at the end of the set time.

1. Touch  until  symbol appears on display.

 Maximum alarm time can be 23 hours and 59 minutes.

2. Set the alarm duration by using  /  keys.



 Function keys for alarm tone, time of day, display brightness and temperature keys should be at 0 (OFF) position.

- »  symbol will remain lit and the alarm time will appear on the display once the alarm time is set.
3. At the end of the alarm time,  symbol starts flashing and the audio warning is heard.

Turning off the alarm





1. Audio warning sounds for 2 minutes. To stop the audio warning, just press any key.
» Audio warning will be silenced and current time will be displayed.

Cancelling the alarm;

1. Touch  until  symbol appears on display in order to cancel the alarm.
2. Press and hold  key until "00:00" is displayed.





 Alarm time will be displayed. If the alarm time and cooking time are set concurrently, shortest time will be displayed.

Changing alarm tone

1. Touch  until  symbol appears on display.
2. Adjust the desired alarm tone with  /  keys.
3. The tone you have set will be activated in a short time.
» Selected alarm tone will appear as "b-01", "b-02" or "b-03" on the display.

Changing the time of the day

To change the time of the day you have previously set:

1. Touch  until  symbol appears on display.
2. Set the time of the day with  /  keys.
3. The time you have set will be activated in a short time.

Economy mode

You can save energy with economy mode while cooking by setting cooking time in the oven. This mode completes the cooking with the inner temperature of the oven by switching off the heaters before the end of cooking time.

Setting the economy mode

1. Touch  symbol until **eco** symbol appears on display.
 - » **"OFF"** will appear on the display.
2. Enable economy mode by touching **+** key.
 - » Once the economy mode is activated, **"On"** appears on the display and the eco symbol remains lit.

Disabling economy mode

1. Touch  symbol until **eco** symbol appears on display.

- » **"On"** will appear on the display.
2. Disable economy mode by touching **■** key.
 - » **"Off"** will be displayed once the eco mode is deactivated.

Setting the screen brightness

1. Touch  until **d-01** or **d-02** or **d-03** appears on display for display brightness.
2. Set the desired brightness with **+**/**■** keys.
 - » The time you have set will be activated in a short time.

Cooking times table



1st rack of the oven is the **bottom** rack.



Maximum load capacity of oven tray: 4 kg (8.8 lb).



The timings in this chart are meant as a guide. Timings may vary due to temperature of food, thickness, type and your own preference of cooking.

Baking and roasting

Dish	Cooking level number	Operating Mode (see p.21)	Rack position	Temperature (°F)	Cooking time (approx. in min.)
Cakes in tray*	One level		4	350	25... 30
Cakes in mould*	One level		2	355	40... 50
Cakes in cooking paper*	One level		3	350	25... 30
	2 levels		1 - 5	350	30... 40
	3 levels		1 - 3 - 5	360	45... 55
Sponge cake*	One level		3	390	5... 10
	2 levels		1 - 5	350	20... 30
Cookies*	One level		3	350	25... 30
	2 levels		1 - 5	350 ... 375	30... 40
	3 levels		1 - 3 - 5	350	35... 45
Dough pastry*	One level		2	390	30... 40
	2 levels		1 - 5	390	45... 55
	3 levels		1 - 3 - 5	390	55... 65
Filled savory pastry*	One level		2	390	25... 35
	2 levels		1 - 5	390	35... 45
	3 levels		1 - 3 - 5	375	45... 55
Leaven*	One level		2	390	35... 45
	2 levels		1 - 3	375	35... 45
Lasagna*	One level		2 - 3	390	30... 40
Pizza*	One level		2	390... 430	15... 20
Beef steak (whole) / Roast	One level		3	25 min. max, then 355... 375	100... 120
Leg of Lamb (casserole)	One level		3	25 min. max, then 355... 375	70... 90
Roasted chicken	One level		3	15 min. max, then 355... 375	55... 65
	One level		2	15 min. max, then 355... 375	55... 65
Turkey (5.5 kg)	One level		2	25 min. max, then 355... 375	150... 210
	One level		2	25 min. max, then 355... 375	150... 210
Fish	One level		2	390	20... 30
	One level		3	390	20... 30

When cooking with 2 trays at the same time, place the deeper tray on the upper rack and the other one on the lower rack.
* It is suggested to perform preheating for all foods.

(**) In a cooking that requires preheating, preheat at the beginning of cooking until the thermostat lamp turns off.

Tips for baking cake

- If the cake is too dry, increase the temperature by 50°F (10°C) and decrease the cooking time.
- If the cake is wet, use less liquid or lower the temperature by 50°F (10°C).
- If the cake is too dark on top, place it on a lower rack, lower the temperature and increase the cooking time.
- If cooked well on the inside but sticky on the outside, use less liquid, lower the temperature and increase the cooking time.

Tips for baking pastry

- If the pastry is too dry, increase the temperature by 50°F (10°C) and decrease the cooking time. Dampen the layers of dough with a sauce composed of milk, oil, egg and yoghurt.
- If the pastry takes too long to bake, pay care that the thickness of the pastry you have prepared does not exceed the depth of the tray.
- If the upper side of the pastry gets browned, but the lower part is not cooked, make sure that the amount of sauce you have used for the pastry is not too much at the bottom of the pastry. Try to scatter the sauce equally between the dough layers and on the top of pastry for an even browning.

 Cook the pastry in accordance with the mode and temperature given in the cooking table. If the bottom part is still not browned enough, place it on one lower rack next time.

Tips for cooking vegetables

- If the vegetable dish runs out of juice and gets too dry, cook it in a pan with a lid instead of a tray. Closed vessels will preserve the juice of the dish.
- If a vegetable dish does not get cooked, boil the vegetables beforehand or prepare them like canned food and put in the oven.

How to operate the broil

 Before using the oven the clock time must be set. If the clock time is not set, the main oven will not work.

 **WARNING**
Hot surfaces may cause burns! Keep children away from the product.
 Close oven door during broiling.

Switching on Broil

1. Set the function knob onto the broil symbol.
 2. Set broil temperature.
 3. Preheat for approximately 5 minutes, if it is necessary.
- » The thermostat lamp is switched on.

Switch off broil



1. Turn the function and thermostat knobs to off (upper) position.

Food	Rack position	Broiling time (approx.)
Fish	4...5	20...25 min.*
Sliced chicken	4...5	25...35 min.
Lamb chops	4...5	20...25 min.
Roast beef	4...5	25...30 min.*
Veal chops	4...5	25...30 min.*
Toast bread	4	1...2 min.
* depending on thickness		



6 Maintenance and care

General information

Service life of the product will extend and the possibility of problems will decrease if the product is cleaned at regular intervals.

	DANGER: Disconnect the product from mains supply before starting maintenance and cleaning works. There is the risk of electric shock!
	DANGER: Allow the product to cool down before you clean it. Hot surfaces may cause burns!

- Clean the product thoroughly after each use. In this way it will be possible to remove cooking residues more easily, thus avoiding these from burning the next time the appliance is used.
- No special cleaning agents are required for cleaning the product. Use warm water with washing liquid, a soft cloth or sponge to clean the product and wipe it with a dry cloth.
- **Do not use any abrasive cleaning materials!**
- Do not use cleaning agents that contain acid or chloride to clean the stainless or inox surfaces and the handle. Use a soft cloth with a liquid detergent (not abrasive) to wipe those parts clean, paying attention to sweep in one direction.

	The surface might get damaged by some detergents or cleaning materials. Do not use aggressive detergents, cleaning powders/creams or any sharp objects during cleaning. Do not use harsh abrasive cleaners or sharp metal scrapers to clean the oven door glass since they can scratch the surface, which may result in shattering of the glass.
	Do not use steam cleaners to clean the appliance as this may cause an electric shock.

Cleaning the burner/plate

Ceramic hobs

Always rinse off fully with a clean cloth wrung out in clean water (as residue could damage the ceramic glass surface next time the hob is used). In no case should crusts be scratched off with serrated edge knives, steel wool or the like. Remove calcium stains (yellow staining) with small amounts of decalcifying agents such as Durgol, vinegar or lemon juice. Do not allow vinegar, coffee, milk, saltwater, lemon or tomato juice to remain in contact with enamel parts (i.e. inside the oven). Apply agent with a sponge and, in the event of heavier soiling, let it work in for a longer period of time. Afterwards, wash off hob with water.

	WARNING: Sugar-based food such as custard and syrup should immediately be scraped off without waiting for the surface to cool down. Otherwise the burner/plate may be permanently damaged.
---	--

Cleaning the control panel

Clean the control panel and knobs with a damp cloth and wipe them dry.

	IMPORTANT: Damage of the control panel! Do not remove the control knobs for control panel cleaning.
--	--

Cleaning the oven

No oven cleaner or any other special cleaning agent is required for cleaning the oven. It is recommended to wipe the oven with a damp cloth while it is still warm. Do not allow fat or oils to build up in the oven base, or oven accessories.

To clean the side wall

1. Remove the front section of the side rack by pulling it in the opposite direction of the side wall.
2. Remove the side rack completely by pulling it towards you.

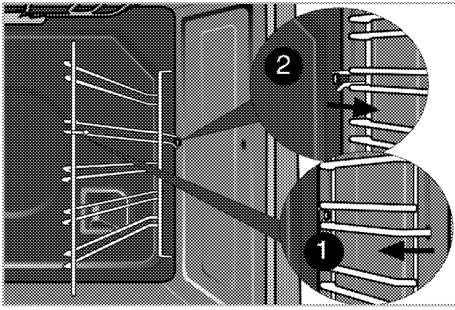

Clean oven door

To clean the oven door, use warm water with washing liquid, a soft cloth or sponge to clean the product and wipe it with a dry cloth.

i Don't use any harsh abrasive cleaners or sharp metal scrapers for cleaning the oven door. They could scratch the surface and destroy the glass.

Removing the oven door

1. Open the front door (1).
2. Open the clips at the hinge housing (2) on the right and left hand sides of the front door by pressing them down as illustrated in the figure.

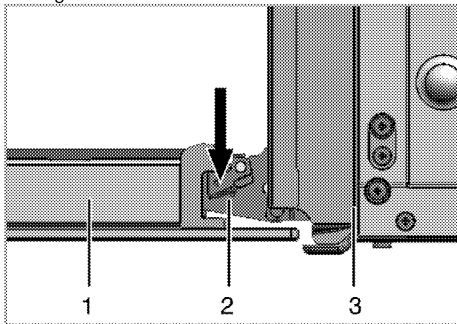

- 1 Front door
- 2 Hinge
- 3 Oven

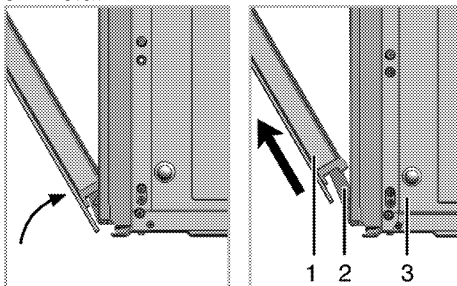

3. Move the front door to half-way.
4. Remove the front door by pulling it upwards to release it from the right and left hinges.

i Steps carried out during removing process should be performed in reverse order to install the door. Do not forget to close the clips at the hinge housing when reinstalling the door.

Replacing the oven lamp

! **DANGER:**
Before replacing the oven lamp, make sure that the product is disconnected from mains and cooled down in order to avoid the risk of an electrical shock.
Hot surfaces may cause burns!

i The lenses must be in place when using the oven.
The lenses serve to protect the light bulb from breaking.
The lenses are made of glass. Handle carefully to avoid breakage. Broken glass could cause an injury.

i Position of lamp might vary from the figure.

Each oven is equipped with one halogen lights located in the back wall of the oven. The lights are switched on when the door is opened or when the oven is in a cooking cycle. The oven lights are not illuminated during self clean. Each light assembly consist of a removable lens, a light bulb as well as a light socket housing that is fixed in place. Light bulb replacement is considered to be a routine maintenance item.

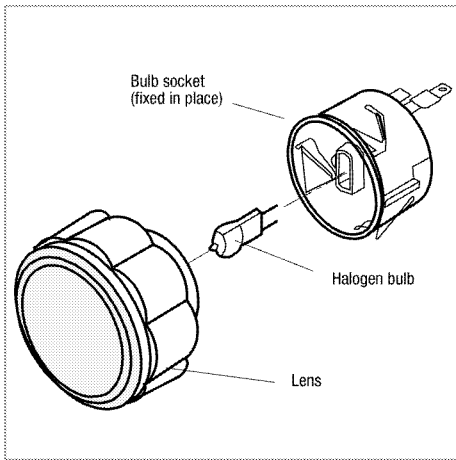

To replace a light bulb:

1. Read warning on this page.
2. Turn off power at the main power supply (your fuse or breaker box).

7 General information

Overview

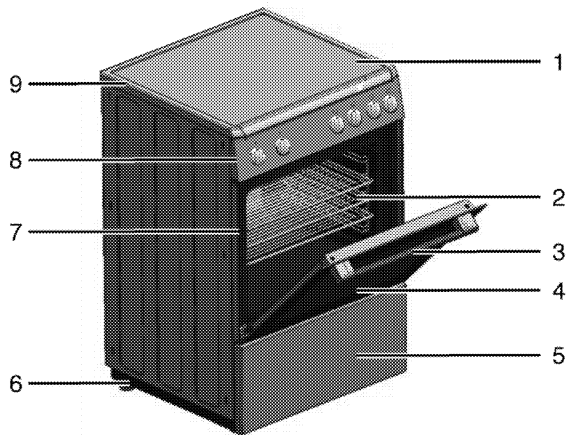

- 1 Ceramic plate
- 2 Wire shelf
- 3 Handle
- 4 Front door
- 5 Bottom part

- 6 Foot
- 7 Shelf positions
- 8 Control panel
- 9 Vitroceramic surface

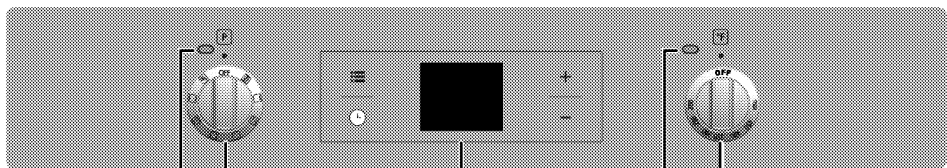

- 1 Function lamp
- 2 Function knob
- 3 Digital timer

- 4 Thermostat lamp
- 5 Thermostat knob

Technical specifications

GENERAL	
External dimensions (height / width / depth)	33 1/3 /23 1/2 x 23 1/2 inches
Voltage / frequency	120/240V ~ 60 Hz
Total electric power	9.8 kW
Fuse protection	Min. 40 A
Cable type / section	DTR 4x10 AWG
Cable length	max. 6 ft
Burners	
Rear left	Induction cooking plate
Size	6 inches (145 mm)
Power	1400/2200 W
Front left	Induction cooking plate
Size	9 inches (210 mm)
Power	2300/3700 W
Right	Induction cooking plate
Size	10 inches (260 mm)
Power	2600/3700 W
OVEN/BROIL	
Main oven	Multifunction oven
Inner lamp	15–25 W
Broil power consumption	2,2 kW



Technical specifications may be changed without prior notice to improve the quality of the product.



Figures in this manual are schematic and may not exactly match your product.



Values stated on the product labels or in the documentation accompanying it are obtained in laboratory conditions in accordance with relevant standards. Depending on operational and environmental conditions of the product, these values may vary.

Package contents



Accessories supplied can vary depending on the product model. Not every accessory described in the user manual may exist on your product.

1. User manual

2. Wire Shelf

Used for roasting and for placing the food to be baked, roasted or cooked in casserole dishes to the desired rack.

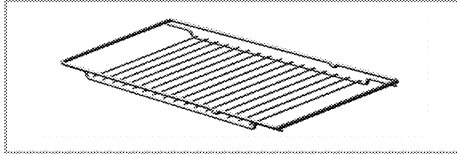

3. Proper positioning of the wire shelf on sliding shelves

It is important to position the broil and/or dripping pan on the wire shelves correctly. Slide the broil or the dripping pan completely between the 2 rails and make sure it is stable before putting a dish on it (Please see the following figure).

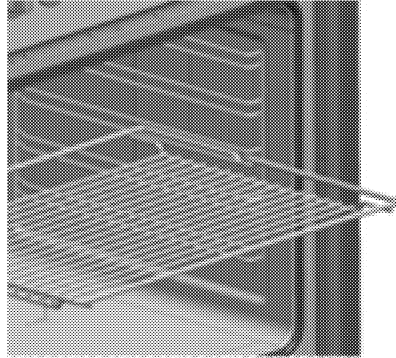
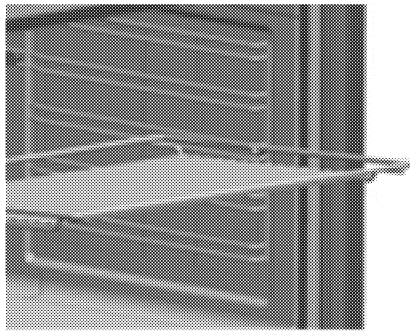

4. Island trim

Remove the island trim assembly from the packaging taking care to retain the screw required for fixing the island trim to the product. Remove the protective films (if supplied) from the island trim before assembly.

Position the island trim assembly as indicated. Secure the island trim assembly to the appliance with the screw provided. Do not over tighten in order to avoid any damages to the product or island trim.

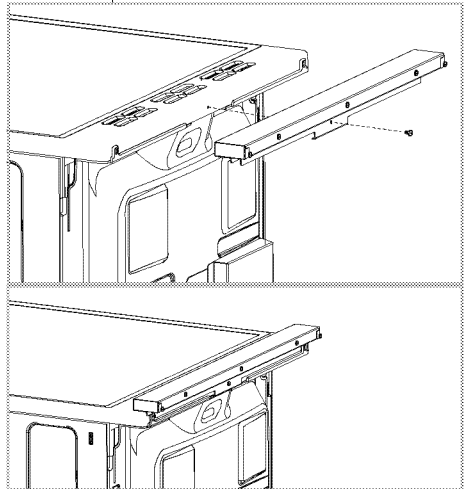

8 Troubleshooting

Oven emits steam when it is in use.

- It is normal that steam escapes during operation. >>> *This is not a fault.*

Product emits metal noises while heating and cooling.

- When the metal parts are heated, they may expand and cause noise. >>> *This is not a fault.*

Product does not operate.

- The mains fuse is defective or has tripped. >>> *Check fuses in the fuse box. If necessary, replace or reset them.*
- Product is not plugged into the (grounded) socket. >>> *Check the plug connection.*

Oven light does not work.

- Oven lamp is defective. >>> *Replace oven lamp.*
- Power is cut. >>> *Check if there is power. Check the fuses in the fuse box. If necessary, replace or reset the fuses.*

Oven does not heat.

- Function and/or Temperature are not set. >>> *Set the function and the temperature with the Function and/or Temperature knob/key.*
- In models equipped with a timer, the timer is not adjusted. >>> *Adjust the time.*
(In products with microwave oven, timer controls only microwave oven.)
- Power is cut. >>> *Check if there is power. Check the fuses in the fuse box. If necessary, replace or reset the fuses.*

(In models with timer) Clock display is blinking or clock symbol is on.

- A previous power outage has occurred. >>> *Adjust the time / Switch of the product and switch it on again.*

The hob or the cooking zone doesn't start-up.

- The hob is badly connected on the electrical network.
- The protection fuse cut-off.
- The looking function is activated.
- The sensitive keys are covered of grease or water.
- An object is put on a key.

The control panel displays [U]:

- There is no pan on the cooking zone.
- The pan is not compatible with induction.
- The bottom diameter of the pan is too small.

The control panel displays [E]:

- The electronic system is defective.
- Disconnect and replug the hob.
- Call after sales

One or all cooking zone cut-off:

- The safety system functioned.
- You forgot to cut-off the cooking zone for a long time.
- One or more sensitive keys are covered.
- The pan is empty and its bottom overheated.
- The hob also has an automatic reduction of Booster level and breaking Automatic overheating

Continuous ventilation after cutting off the hob:

- This is not a failure, the fan continuous to protect the electronic device.
- The fan cooling stops automatically.

The automatic cooking system doesn't start-up:

- The cooking zone is still hot [H].
- The highest Booster level is set [9].

The control panel displays []:

- Refer to the chapter "Keep warm".

The control panel displays [II]:

- Refer to the chapter "Stop&Go"

The control panel displays [] or [Er03]:

- Water sprinkled on glass surface may cause permanent touch button activation.  icon may shown on display and buzzer beeps. Clean the surface to continue to use hob when water or cooking utensils on the glass.

The control panel displays [E2]:

- The hob is overheated, let it cool and then turn it on again.

The control panel displays [E8]:

- The air inlet of the ventilator is obstructed, release it.



Consult the Authorised Service Agent or technician with licence or the dealer where you have purchased the product if you can not remedy the trouble although you have implemented the instructions in this section. Never attempt to repair a defective product yourself.

9 WARRANTY STATEMENT FOR BLOMBERG ELECTRIC AND GAS RANGES

The warranties provided by Blomberg in these statements only apply to Blomberg electric and gas ranges sold to the original purchaser or homeowner in the US and Canada. This warranty is not transferable.

To obtain warranty service, please contact our nearest distributor as listed by state or call 1800-459-9848. You will need your electric and gas range model number, serial number, retailer name and address, where purchased and purchase date / installation date.

This warranty gives you specific legal rights, and you may also have other rights which vary from state to state.

All warranties stated below are based upon normal household use. The use of the product in a commercial setting will void all warranties.

Service must also be performed by an authorized Blomberg Service Agency.

Cosmetic defects must be reported within 10 business days from installation

1 year * limited warranty from date of first installation Blomberg will repair or replace at no cost to the consumer any defective parts of the electric and gas ranges

2 year * ++ limited warranty from date of first installation (Parts only) Blomberg will repair or replace any parts at no cost to the consumer if material defects or workmanship have caused the damage or failure of these components. Labor charges are the responsibility of the consumer

2-5 year * ++ limited warranty from date of first installation (Parts only) Blomberg will repair or replace oven cavity at no cost to the consumer if material defects or workmanship have caused the damage or failure of these components. Labor charges are the responsibility of the consumer

Disclaimers of warranties and exclusions:

Warranty does not cover service costs by an authorized service agent to correct installation, electrical problems or educational instruction on the use of the electric and gas ranges. The warranty also does not cover defects or damage caused by an act of god (such as storms, floods, fires, mudslides, etc.), damage cause by use of the electric and gas ranges for purposes other than those for which it was designed, misuse, abuse, accident, alteration, improper installation, maintenance, travel fees, service calls outside normal service hours, unauthorized service work or work.

This product is fully tested and went through official quality assurance inspections before leaving the original manufacturing site. Warranty

terms for this Blomberg household appliance is not valid if the product is altered, tampered, modified, additional parts assembled, fixed and re-packed by an authorized distributor, servicer, a third party retailer, reseller or by any other unauthorized person(s).

TO THE EXTENT PERMITTED BY LAW, THIS WARRANTY IS IN LIEU OF ALL OTHER EXPRESSED AND IMPLIED WARRANTIES, INCLUDING THE IMPLIED WARRANTIES OF MERCHANTABILITY AND FITNESS FOR A PARTICULAR PURPOSE. BLOMBERG UNDERTAKES NO RESPONSIBILITY FOR THE QUALITY OF THIS PRODUCT EXCEPT AS OTHERWISE PROVIDED IN THIS WARRANTY STATEMENT. BLOMBERG ASSUMES NO RESPONSIBILITY THAT THE PRODUCT WILL BE FIT FOR ANY PARTICULAR PURPOSE FOR WHICH YOU MAY BE BUYING THIS PRODUCT, EXCEPT AS OTHERWISE PROVIDED IN THIS WARRANTY STATEMENT.

Blomberg does not assume any responsibility for incidental or consequential damages. Such damages include, but are not limited to, loss of profits, loss of savings or revenue, loss of use of the cooker or any associated equipment, cost of capital, cost of any substitute equipment, facilities or services, downtime, the claims of third parties, and injury to property. Some states do not allow the exclusion or limitation of incidental or consequential damages, so the above limitations or exclusion may not apply to you.

* installation date shall refer to either purchase date or 5 business days after delivery of the product to the home, whichever is later.

++Parts replaced will assume the identity of the original parts + their original warranty.

No Other Warranties. This Warranty Statement is the complete and exclusive warranty from the manufacturer. No employee of Blomberg or any other party is authorized to make any warranty statements in addition to those made in this Warranty Statement.

Please keep this warranty card, user manual and your sales slip for future reference.

HOW TO GET SERVICE

Please contact the Distributor for your State or Province as listed on the Distributor Contact List, or call our Toll Free Number at 1 800 459 9848 for direction to an Authorized Blomberg Service Agent. 02 01