

CB300UI

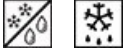

Product family	Refrigerator
Installation	Built-in
Category	Bottom mount
No-frost system	Total
Cooling type	Fan-assisted refrigerator, no-frost freezer
Defrost	Automatic
Hinge	Door-to-door
Hinge position	Right
Reversible door	Yes
EAN code	8017709246884



Aesthetic



Finishing	Panel-ready	Glass shelf profile color	White
Material	Steel	Display	LED
Side material	Steel	Display position	Internal
Logo	Silkscreened		

Refrigerator compartment features



No. of adjustable shelves	3	Crisper cover	Yes
Number of fruit and vegetables drawers	2	Refrigerator lighting	LED
Type of adjustable shelves	Glass		

Refrigerator Inner Door

No. of door shelves with transparent cover	1	No. of bottle shelves	1
Number of adjustable door shelves	1	Door bin with wire support	Yes

Other Refrigerator features



Fan	Yes	Anti-odour filter	Yes
------------	-----	--------------------------	-----

Freezer features

Number of drawers	2	No. of shelves	1
--------------------------	---	-----------------------	---

Other Freezer features



Accessories	1 x ice box	Fast-freezing compartment	Yes
Ice maker	Yes		

Other technical features



Display functions	Holiday, Fast-freezing, Fast-cooling, ECO
Fast-freezing button	Yes
Water network connection	Yes
Power-on light	Yes
Temperature alarm	Yes
Door open alarm	Yes
Temperature setting type	Electro-mechanical
No. of compressors	1
Refrigerant gas type	R600a
Foam agent	Cyclopentane

Performance / Energy Label NEW







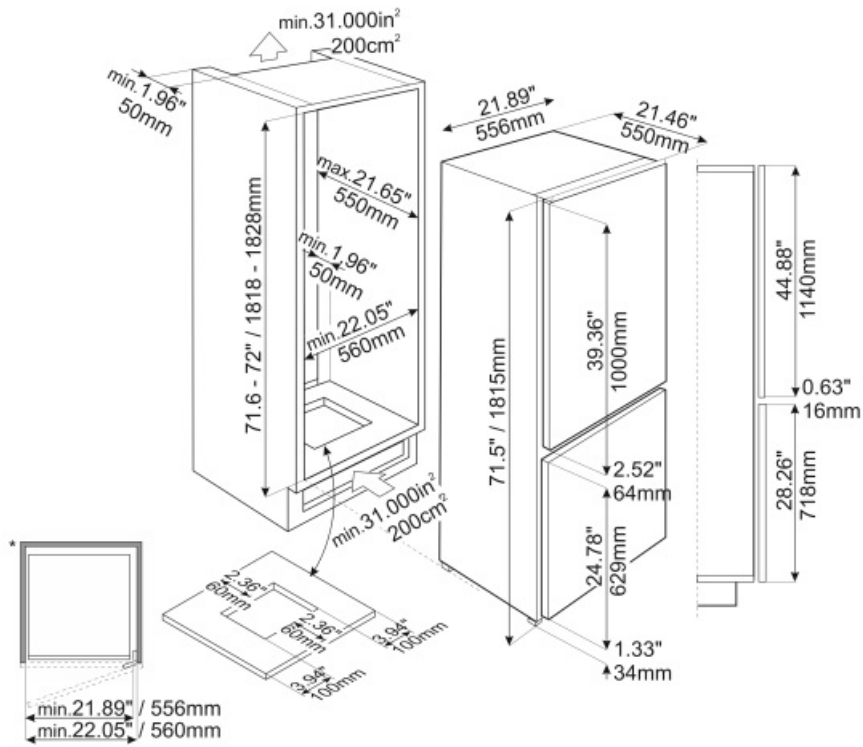

Noise level	39 dB(A) re 1 pW
--------------------	------------------

Electrical Connection

Plug	(A) USA & Mexico	Voltage (V)	120 V
Electrical connection rating	170 W	Frequency (Hz)	60 Hz
Current	2,1 A	Power cord length	84 5/8 "



Symbols glossary (TT)

	The automatic defrost system works by automatically defrosting at regular intervals eliminating the need to defrost altogether.		LED display: to show programmes, functions and options selected and the time to the end of the cycle.
	Economical mode: Analyzes fridge functioning during the activation and optimizes the operating cycle in order to reduce power consumption.		Ventilated: Forced distribution of cold air in the refrigerator compartment, which allows even temperature distribution within the fridge.
	Fast freezing: The fast freezing function brings the temperature of the compartment down when activated a few hours prior to usage.		Power saving mode: The power saving mode allows you to disable the refrigerator and keep the freezer working.
	LED interior lighting: is a more energy efficient and long lasting way of illuminating the interior of the appliance.		No Frost: The No Frost and Frost free systems prevent ice from forming so that no defrosting is required.