



Scan to see the online manual.



OWNER'S MANUAL

CERAMIC-GLASS RADIANT COOKTOP

Read this owner's manual thoroughly before operating the appliance and keep it handy for reference at all times.

ENGLISH

CBED2415B



MFL54169113
Rev.02_082024

www.lg.com

Copyright © 2023-2024 LG Electronics. All Rights Reserved

TABLE OF CONTENTS

3 IMPORTANT SAFETY INSTRUCTIONS

- 3 READ ALL INSTRUCTIONS BEFORE USE
- 3 WARNING STATEMENTS
- 6 CAUTION STATEMENTS

8 PRODUCT OVERVIEW

- 8 Product Features

9 INSTALLATION

- 9 Before Installing
- 12 Installing the Cooktop

16 OPERATION

- 16 Cookware
- 18 Control Panel

24 MAINTENANCE

- 24 Care and Cleaning

26 TROUBLESHOOTING

- 26 Before Calling for Service

29 LIMITED WARRANTY

- 29 USA
- 33 CANADA

IMPORTANT SAFETY INSTRUCTIONS

READ ALL INSTRUCTIONS BEFORE USE

Safety Messages

Your safety and the safety of others are very important.

We have provided many important safety messages in this manual and on your appliance. Always read and follow all safety messages.

Download this owner's manual at <http://www.lg.com>



This is the safety alert symbol.

This symbol alerts you to potential hazards that can kill or injure you and others. All safety messages will follow the safety alert symbol and either the word WARNING or CAUTION.

These words mean:



WARNING

You may be killed or seriously injured if you do not follow instructions.



CAUTION

You may be injured or cause damage to the product if you do not follow instructions.

All safety messages will tell you what the potential hazard is, tell you how to reduce the chance of injury, and tell you what may happen if the instructions are not followed.

WARNING STATEMENTS

WARNING

- To reduce the risk of explosion, fire, death, electric shock, scalding or injury to persons when using this product, follow basic precautions, including the following:

Installation

- Be sure your appliance is properly installed and grounded by a qualified technician in accordance with the National Electrical Code ANSI/NFPA No. 70, latest edition in the United States, and all local code requirements. Install only per installation instructions.
- The safety aspects of this appliance comply with accepted technical standards.
- Never modify or alter the construction of an appliance such as removal of panels, wire covers or any other permanent part of the product.
- Remove all tape and packaging wrap before using the appliance. Destroy the carton and plastic bags after unpacking the appliance. Never allow children to play with packaging material.
- The installation and connection of the new appliance must only be carried out by qualified personnel.

Operation

- Know how to disconnect the electrical power to the appliance at the circuit breaker or fuse box in case of an emergency. Mark the breaker or fuse for ease of identification and swift action if necessary.
- Never use your appliance for warming or heating a room.
- DO NOT touch cooking zones or areas near these surfaces. Cooking zones may be hot from residual heat even though they are dark in color. Areas near the cooking zones may become hot enough to cause

4 IMPORTANT SAFETY INSTRUCTIONS

burns. During and after use, do not touch, or let clothing or other flammable materials touch, these areas until they have had sufficient time to cool.

- Never wear loose fitting or hanging garments while using this appliance.
- Always turn off all controls when cooking is completed.
- Do not use water or flour on grease fires. Smother the fire with a pan lid, or use baking soda or a dry chemical or foam-type extinguisher.
- Use only dry pot holders. Moist or damp pot holders on hot surfaces may result in burns from steam. Do not let pot holders touch hot surface units. Do not use a towel or other bulky cloth instead of a pot holder.
- Do not heat unopened food containers. A buildup of pressure may cause the container to burst and result in injury.
- Flammable materials should not be stored near or on the cooking surface. This includes paper, plastic and cloth items, such as cookbooks, plasticware and towels, as well as flammable liquids. Do not store explosives, such as aerosol cans, on or near the appliance. Flammable materials may explode and result in fire or property damage.
- Do not store or use gasoline or other flammable vapors and liquids in the vicinity of this or any other appliance.
- Never place combustible items on the cooktop.
- Never keep any combustible items or aerosol cans in a drawer located under the cooktop.
- When heating fat or grease, watch it closely. Fat or grease may catch fire if allowed to become too hot.
- Overheated fats and oils catch fire quickly. You should supervise cooking when preparing foods in fat or oil.
- Use a deep fat thermometer, if possible, to prevent overheating fat beyond the smoking point.
- If the surface is cracked, switch off the appliance to avoid the possibility of electric shock. Do not reuse your cooktop until the glass surface has been replaced.
- When using the cooktop, never use aluminum foil, products wrapped in aluminum foil, or deep-frozen food in aluminum cookware.
- This appliance is not intended for use by young children or infirm persons unless they have been adequately supervised by a responsible person to ensure that they can use the appliance safely.
- Young children should be supervised to ensure that they do not play with the appliance.
- Accessible parts may become hot during use. Young children should be kept away.
- Items of interest to children should not be stored in cabinets above a cooktop or on the backsplash of a cooktop – children climbing on the cooktop to reach items could be seriously injured.
- Children should not be left alone or unattended in the area where an appliance is in use. They should never be allowed to sit or stand on any part of the appliance.
- Take care when plugging in electric appliances near the cooktop. Cords must not come into contact with the hot surface. Doing so could cause damage to the cooktop and cable insulation.
- After use, switch off the cooktop element by its control and do not rely on the pan detector.
- Avoid placing metal objects such as knives, forks, spoons and lids on the cooking surface areas. Metal objects can become hot and cause burns.
- Do not place any object on or near the display area in order to prevent accidental activation of the cooktop controls.
- Cookware handles should be turned inward and not extend over adjacent surface units. To reduce the risk of burns, ignition of flammable materials, and spillage due to unintentional contact with the cookware, the handles of cookware should be positioned so that they are turned inward, and do not extend over adjacent surface units.
- Never leave prepared food on the cooking zones. Boilovers cause smoking and greasy spillovers that may ignite, or a pan that has boiled dry may melt or become damaged.

- Do not use aluminum foil to line any part of the cooktop. Only use aluminum foil as recommended after the cooking process, if used as a cover to be placed over the food. Any other use of aluminum foil may result in the risk of electric shock, fire or short circuit.
- Do not clean or operate a broken cooktop. If the cooktop breaks, cleaning solutions and spillovers may penetrate the broken cooktop and create a risk of electric shock. Contact a qualified technician immediately.
- Never leave surface units unattended at high heat settings. Boilover causes smoking and greasy spillovers that may ignite.
- Always turn off all controls when cooking is completed.
- Keep pets away from the product to avoid risk of fire or burns. Do not allow pets to climb on the product even when it is not in operation.
- Liquids such as water, coffee or tea are able to be overheated beyond the boiling point without appearing to be boiling, due to surface tension of the liquid. Visible bubbling or boiling is not always present when the container is removed from the cooktop. This could result in very hot liquids suddenly boiling over when the container is disturbed or a spoon or other utensil is inserted into the liquid. To reduce the risk of injury to persons:
 - Do not overheat the liquid.
 - Stir the liquid both before and halfway through heating it.
 - Do not use straight-sided containers with narrow necks.
 - After heating, allow the container to stand on the cooktop for a short time before moving the container.
 - Use extreme care when inserting a spoon or other utensil into the container after heating.
- Do not use the cooktop as a work surface or storage space.
- Do not operate the cooking zones with empty pots or pans.
- Do not turn on the cooking zones with no pots or pans on the element.
- The cooking process has to be supervised. A short term cooking process has to be supervised continuously.
- The appliance must not be installed behind a decorative door in order to avoid overheating.

Maintenance

- Do not repair or replace any part of the appliance. All servicing should be done only by a qualified technician to avoid the risk of personal injury and damage to the appliance.
- Take care to avoid steam burns if using a wet sponge or cloth to wipe spills on a hot cooking area.
- Wait for the cooktop to cool before using cooktop cleaners. Some cleaners can produce NOXIOUS FUMES if applied to a hot surface.
- If the supply cord is damaged, it must be replaced by the manufacturer, its service agent or similarly qualified persons in order to avoid a hazard.
- If your appliance malfunctions or fractures, switch off all cooking zones, and contact an LG Customer Information Center for service.
- Always keep the control panel clean and dry. Do not let liquids or grease remain on the cooktop display area. Spilled or burnt-on foods can activate or deactivate the appliance. Clean the display area thoroughly to resume normal operation of the appliance.
- Clean the appliance regularly to keep all parts free of grease that could catch fire. Exhaust fan ventilation hoods and grease filters should be kept clean. Do not allow grease to accumulate on the hood or filters. Greasy deposits in the fan could catch fire. Refer to the hood manufacturer's instructions for cleaning.

CAUTION STATEMENTS

CAUTION

- To reduce the risk of minor or moderate injury to persons, malfunction, or damage to the product or property when using this product, follow basic precautions, including the following:
-

Operation

- This appliance may only be used for normal cooking and frying in the home. It is not designed for commercial or industrial purposes.
- Use proper pan sizes. This appliance is equipped with one or more surface units of different sizes.
- Select cookware having flat bottoms large enough to cover the cooking zones.
- Only certain types of glass, glass/ceramic, ceramic, earthenware, or other glazed cookware are suitable for rangetop service without breaking due to the sudden change in temperature. Check the manufacturer's recommendations for cooktop use.
- Do not place hot cookware on cold cooktop glass. This could cause the glass to break.
- Do not slide pans across the cooktop surface. They may scratch the cooktop surface.
- Do not let pans boil dry. This may cause permanent damage in the form of breakage, fusion, or marking that can affect the ceramic-glass cooktop. (This type of damage is not covered by your warranty.)
- Cook meat and poultry thoroughly, meat to at least an INTERNAL temperature of 160 °F and poultry to at least an INTERNAL temperature of 180 °F. Cooking to these temperatures usually protects against food-borne illnesses.
- Prior to using the cooktop for the first time, apply the recommended cooktop cleaning cream to the ceramic surface. Buff with a non-abrasive cloth or pad. This will make cleaning easier when the cooktop gets soiled from cooking. The special cooktop cleaning cream leaves a protective finish on the glass to help prevent scratches and abrasions.
- Please be careful of the cooktop edges when moving pots and pans.
- Ceramic glass is very tough, and impervious to sharp temperature changes, but is not unbreakable. It can be damaged if hard or sharp objects fall on it.
- Be very cautious if using pots made of cast iron, or other pots with rough edges or burrs. Moving these can cause scratches on the glass.
- Do not slide metal or glass across the cooktop surface.
- Do not use cookware with any dirt buildup on the bottom.
- Do not use cookware with rough or uneven bottoms. This cookware can mark and scratch the cooktop surface.
- Do not use the glass cooktop surface as a cutting board.
- The appliance is not intended to be operated by means of an external timer or separate remote-control system.

Maintenance

- Always switch off the appliance before cleaning.
- For safety reasons, do not clean the appliance with a steam jet or high-pressure cleaner.
- Clean the cooktop in accordance with the maintenance and cleaning instructions in this manual.
- Do not use harsh abrasive cleaners or rough metal scrapers to clean the cooktop glass since they can scratch the surface, which may result in shattering of the glass.
- Clean the cooktop cautiously. Do not use sponges or cloth to wipe spills on a hot cooking area. Use a proper metal scraper.

- If sugar or a mixture containing sugar falls onto a hot cooking zone and melts, remove it with a metal scraper immediately, while still hot. If left to cool down, it may damage the surface when removed. Use caution and wear an oven mitt to avoid burns.
- Keep meltable objects or materials away from the ceramic glass surface, for example, plastic utensils, aluminum foil, or cooking wraps. If any materials or foodstuffs melt on the ceramic-glass surface, these should be cleaned up immediately.
- Use oven mitts to avoid burns when using a metal scraper on a hot cooking zone.
- Refer to the Maintenance section for proper cleaning and maintenance of the cooktop.

Disposal of Old Appliances

To protect the environment, it is important that worn-out appliances are disposed of in the correct manner.

- The appliance must not be disposed of with household rubbish.
- You can obtain information about collection dates or public refuse disposal sites from your local government or waste collection service.
- Before disposing of old appliances make them inoperable so they cannot be a source of danger. To do this, have a qualified person disconnect the appliance from the house circuitry.

SAVE THESE INSTRUCTIONS

PRODUCT OVERVIEW

Product Features

Parts and Features

Throughout this manual, features and appearance may vary from your model.

CBED2415B

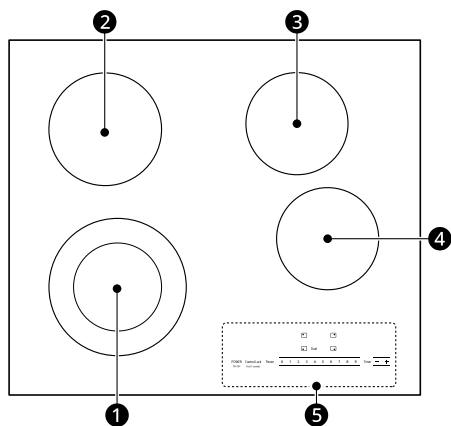

Parts and Features	
①	Left Front (Single: 5", 1000 W / Dual: 8", 2000 W)
②	Left Rear (7", 1500 W)
③	Right Rear (6", 1200 W)
④	Right Front (6", 1200 W)
⑤	Control Panel

Accessories

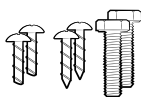

①

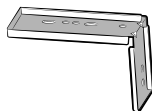

②

① 6 screws

- M4L10 (2 ea)
- M4L16 (2 ea)
- M4L75 (2 ea)

② Bracket Guide (2 ea)

INSTALLATION

Before Installing

Before You Begin

Installation and service must be performed by a qualified installer.

Important: Save these instructions for the local electrical inspector's use. Read and save these instructions for future reference.

Read these instructions completely and carefully.

⚠ CAUTION

- If storage is located under the cooktop, do not use it to store flammable or heat-sensitive items such as detergents, aerosols, cleaners, water, food, or plastics.

NOTE

Installer:

- Read all installation instructions before installing the cooktop.
- Remove all packing material before connecting the electrical supply to the cooktop.
- Observe all governing codes and ordinances.
- Only certain cooktop models may be installed over certain built-in electric oven models.
- Be sure to leave these instructions with the consumer.

NOTE

Consumer:

- Keep the owner's manual and installation instructions for future reference.

NOTE

- This appliance must be properly grounded.
- Damage caused by failure to follow these instructions is not covered by the cooktop warranty.

Tools Needed

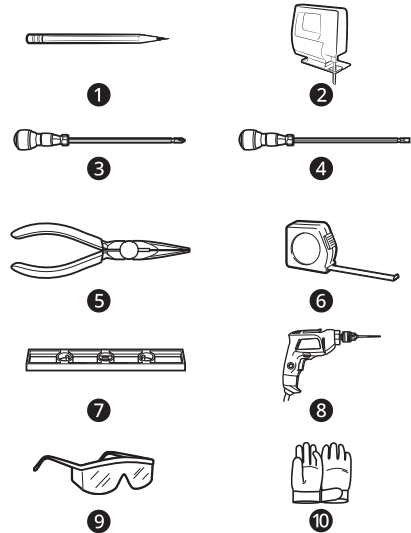

- 1 Pencil
- 2 Saber Saw
- 3 Phillips Screwdriver
- 4 Flat-Blade Screwdriver
- 5 Pliers
- 6 Tape Measure
- 7 Level
- 8 Drill
- 9 Safety Glasses
- 10 Gloves

Parts not Provided

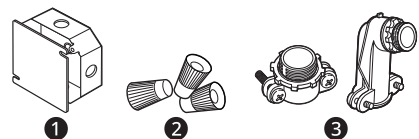

- 1 Junction Box
- 2 Wire Nuts
- 3 Strain Relief (Conduit Connector)

Unpacking the Cooktop

- 1 Unpack and visually inspect the cooktop for any damage or missing components.

Model and Serial Number Location

The model and serial numbers are located on a plate on the bottom of the cooktop. Please record them in this guide; you will need them for warranty registration.

Technical Specifications

Models		CBED2415B		
Description		Radiant Cooktop		
Electrical Specifications	Connection voltage	240/208 VAC 60 Hz., 14.6 A/12.5 A		
	Maximum connected power load	3500 W/2600 W		
Cooktop Dimensions		23 5/8" (600 mm) (W) x 3 3/8" (86 mm) (H) x 20 7/16" (520 mm) (D)		
Countertop Cutout Dimensions		22" - 22 1/8" (558 mm - 562 mm) (W) x 18 13/16" - 19" (478 mm - 482 mm) (D)		
Cooking Zones		Position	Size	Power
		Left Front	5"/8" (127 mm/203 mm)	1000 W/2000 W
		Left Rear	7" (178 mm)	1500 W
		Right Rear	6" (152 mm)	1200 W
		Right Front	6" (152 mm)	1200 W

NOTE

- The maximum power of each cooking zone depends on the size and material of the cookware used.

Preparing the Installation Location

Important Installation Information

- All electric cooktops run off a single phase, three-wire or four-wire cable, 240/208 volt, 60 hertz, AC-only electrical supply with ground.
- Minimum distance between cooktop and overhead cabinetry is 30" (762 mm).
- Make sure the cabinets and wall coverings around the cooktop can withstand the temperatures (up to 90 °C [194 °F]) generated by the cooktop.

Dimensions and Clearances

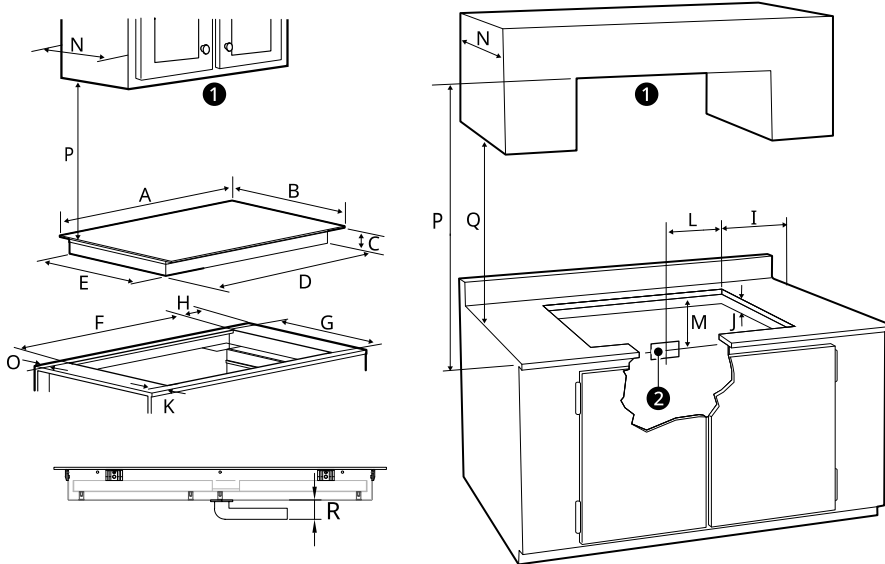

- ❶ Do not obstruct these areas.
- ❷ Approximate location of junction box

-	Dimension/Clearance	CBED2415B
A	Width of upper plate	23 5/8" (600 mm)
B	Depth of upper plate	20 7/16" (520 mm)
C	Height of cooktop base	2 3/16" (56 mm)
D	Width of cooktop base	21 9/16" (548 mm)
E	Depth of cooktop base	18 7/16" (468 mm)
F	Width of cutout	22" - 22 1/8" (558 mm - 562 mm)
G	Depth of cutout	18 13/16" - 19" (478 mm - 482 mm)
H	Distance from side edge of cutout to side of counter	≥ 1" (26 mm)
I	Distance from edge of cooktop to nearest combustable wall (either side of unit)	1" (26 mm)

12 INSTALLATION

-	Dimension/Clearance	CBED2415B
J	Height below cutout (Empty space is needed underneath the cooktop for installation purposes.)	$\geq 4 \frac{3}{16}$ " (107 mm)
K	Distance from front of counter to front edge of cutout	$\geq 1 \frac{1}{2}$ " (38 mm)
L	Junction box (approximate location)	≤ 10 " (254 mm)
M	Junction box (approximate location)	≥ 15 " (381 mm)
N	Depth of overhead cabinets	≤ 13 " (330 mm)
O	Cut area and backwall of cooktop	$\geq 1 \frac{1}{8}$ " (28 mm)
P	Clearance from top of cooking surface to bottom of overhead cabinets	≥ 30 " (762 mm)
Q	Clearance from countertop to bottom of adjacent cabinets	≥ 18 " (457 mm)
R	Height of conduit	1" (26 mm)

All dimensions are stated in inches and millimeters (mm).

Allow 2" (50 mm) below the armored cable opening to clear the electric cable and allow space for installation of the junction box on the wall at the back of the cooktop.

⚠ CAUTION

- To eliminate the risk of burns or fire by reaching over heated surfaces, cabinet storage space located above the cooktop should be avoided. If cabinet storage is provided, risk can be reduced by installing a range hood that projects horizontally a minimum of 5" (127 mm) beyond the face of the cabinets.
- It is very important to keep 2" (51 mm) distance between the cooktop and an oven installed below it.

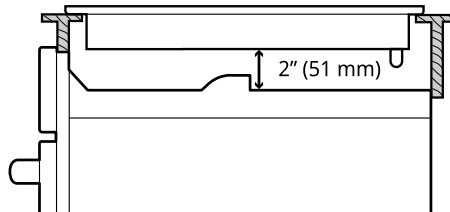

Installing the Cooktop

Electrical Connections

Important Safety Instructions

- Be sure the cooktop is installed and grounded properly by a qualified installer or service technician.
- This cooktop must be electrically grounded in accordance with local codes or, in their absence, with the National Electrical Code ANSI/NFPA No. 70, latest edition in the United States.

⚠ WARNING

- The electrical power to the cooktop must be shut off while line connections are being made. Failure to do so could result in serious injury or death.

Providing the Electrical Connection

- Install the junction box under the cabinet and run 120/240 or 120/208 Volt, AC wire from the main circuit panel.

NOTE

- DO NOT connect the wire to the circuit panel at this time.

Electrical Requirements

Observe all governing codes and local ordinances

- 1 A 3-wire or 4-wire single-phase 120/240 or 120/208 Volt, 60 Hz AC-only electrical supply is required on a separate circuit fused on both sides of the line (time-delay fuse or circuit breaker is recommended). DO NOT fuse neutral. The fuse size must not exceed the circuit rating of the appliance specified on the nameplate.
- 2 This appliance can consume up to 3500 W at 240 VAC. At least 30 Amp circuit breaker with #8 AWG must be used.

⚠ WARNING

- Do not use an extension cord with this appliance. Doing so may result in a fire, electrical shock, or other personal injury.

NOTE

- Wire sizes and connections must conform to the fuse size and rating of the appliance in accordance with the National Electrical Code ANSI/NFPA No. 70, latest edition, and local codes and ordinances.

- 3 The appliance should be connected to the fused disconnect (or circuit breaker) box through flexible armored or nonmetallic sheathed cable. The flexible armored cable extending from this appliance should be connected directly to the grounded junction box. The junction box should be located as shown in **Dimensions and Clearances** with as much slack as possible remaining in the cable between the box and the appliance, so it can be moved if servicing is ever necessary.
- 4 A suitable strain relief must be provided to attach the flexible armored cable to the junction box.

Electrical Connection

Connect the flexible armored cable that extends from the surface unit to the junction box using a suitable strain relief at the point the armored cable enters the junction box. Then make the electrical connection as follows.

Electrical ground is required on this appliance.

This appliance is manufactured with a supply wire and a frame-connected green or bare copper grounding wire.

NOTE

TO ELECTRICIAN:

- The armored cable leads supplied with the appliance are UL-listed for connection to larger gauge household wiring. The insulation of the leads is rated at temperatures much higher than the temperature rating of household wiring. The current-carrying capacity of the conductor wire is governed by the temperature rating of the insulation around the wire, rather than the wire gauge alone.

⚠ WARNING

- DO NOT ground to a gas supply pipe. DO NOT connect to electrical power supply until appliance is permanently grounded. Connect the ground wire before turning on the power.
- This appliance is equipped with a copper conductor flexible cable. If connection is made to aluminum house wiring, use only special connectors which are approved for joining copper and aluminum wires in accordance with the National Electrical Code and local codes and ordinances. Improper connection of aluminum house wiring to copper leads can result in a short circuit or fire. Follow the connector manufacturer's recommended procedure closely.

Where Local Codes Permit Connecting the Appliance-Grounding Conductor to the Neutral (White) Wire

Observe all governing codes and local ordinances.

- 1 Disconnect the power supply.
- 2 At the circuit breaker box, fuse box or junction box, connect appliance and power supply cable wires as shown.

⚠ WARNING

- You may not ground the cooktop through the neutral (white) wire if cooktop is used in a new branch circuit installation (1996 NEC), mobile home, recreational vehicle, or where local codes do not permit grounding to the neutral (white) wire. When grounding to the neutral (white) wire is prohibited, you must use a 4-wire power supply cable. Failure to heed this warning may result in electrocution or other serious personal injury.

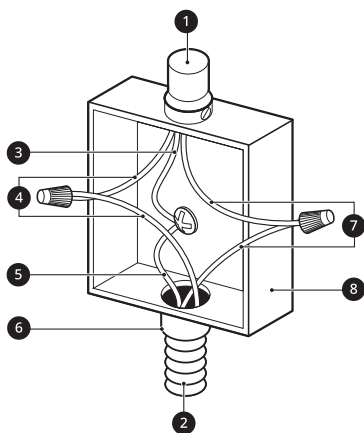
3-Wire Grounded Junction Box

- 1 Cable from Power Supply
- 2 Cable from Cooktop
- 3 White Wire (Neutral)
- 4 Red Wires
- 5 Green Wire (Ground)
- 6 UL-listed Conduit Connector
- 7 Black Wires
- 8 Junction Box

If Cooktop is Used in a New Branch Circuit Installation (1996 NEC), Mobile Home, Recreational Vehicle, or where Local Codes Do Not Permit Grounding to the Neutral (White) Wire

Observe all governing codes and local ordinances.

- 1 Disconnect the power supply.
- 2 At the circuit breaker box, fuse box or junction box, connect appliance and power supply cable wires as shown.

⚠ WARNING

- If connecting to a 4-wire power supply cable electrical system, the appliance frame connected ground wire **MUST NOT** be connected to the neutral wire of the 4-wire electrical system.

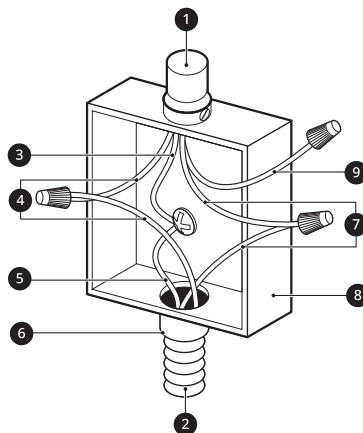
4-Wire Grounded Junction Box

- 1 Cable from Power Supply
- 2 Cable from Cooktop
- 3 Ground Wire
- 4 Red Wires
- 5 Green Wire (Ground)
- 6 UL-listed Conduit Connector
- 7 Black Wires
- 8 Junction Box
- 9 White Wire (No Connection)

Installing the Cooktop Unit

- 1 Visually inspect the cooktop for damage.
- 2 Check and prepare the installation location.
 - See **Dimensions and Clearances**.
- 3 Carefully lower the cooktop into the countertop cutout, making sure not to trap any wires.

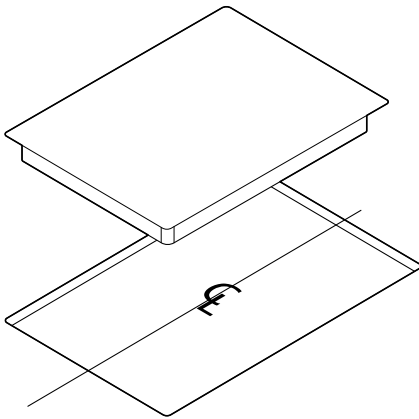

NOTE

- Do not use caulking compound. The cooktop must be removable, should service be required.

- 4 On the bottom of the cooktop, find the holes where the bracket guides attach. (Refer to the figure.)

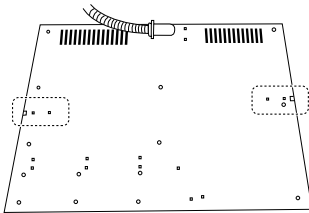

- 5 Align a bracket guide with the hole, and then move it towards the sidewall of the cabinet until it touches the sidewall.

- 6 Use the screws to fasten the bracket guide to the cooktop and the sidewall. Repeat with the second bracket guide.

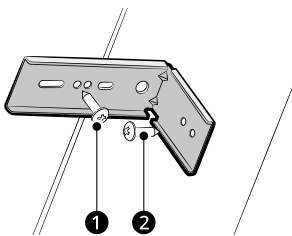

- 1 M4L10 Screw
- 2 M4L16 Screw

NOTE

- Make sure you attach the bracket guides on the left and right sides.
- Make sure that the front edge of the cooktop is parallel to the front edge of the countertop. If repositioning is needed, lift the entire cooktop up from the cutout to avoid scratching the countertop.

Alternative Bracket Guide Installation

- 1 Screw the bracket guides loosely to the bottom of the cooktop and adjust them to the desired positions.
- 2 Once the brackets are adjusted, tighten the screws to attach the bracket guides securely to the bottom of the cooktop.
- 3 Install M4L75 screws until the screws touch the bottom of the countertop.

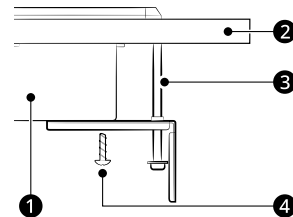

- 1 Cooktop
- 2 Countertop
- 3 M4L75 Screw
- 4 M4L10 Screw

Final Check

Perform a final operational check of the cooktop, making sure the cooktop powers on properly and that each cooking zone operates correctly. Refer to the Operating Instructions in this guide for details.

OPERATION

Cookware

Selecting Cookware

Pots and Pans

The better the pot, the better the cooking results.

- You can recognize good pots and pans by their bases. The base should be as thick and flat as possible.

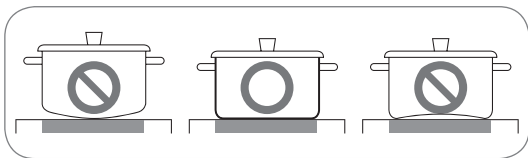

- Pots with aluminum or copper bases can cause metallic discoloring on the ceramic glass surface which is very difficult or impossible to remove.
- Be very careful when using cast iron pots or pots with damaged bases which are rough and or have burrs on them. Scratches can occur if they are slid across the surface.
- When cold, pot bases are normally bowed slightly inwards (concave). They should never be bowed outwards (convex).
- When using specialty cookware such as pressure cookers, simmering pans, or woks, follow the manufacturer's instructions and do not use a very thin pan.

Use Flat-Bottomed Cookware

Cookware must fully contact the surface of the cooking element. Use flat-bottomed pans sized to fit the cooking element and amount of food being prepared. Check for flatness by rotating a ruler across the bottom of the cookware.

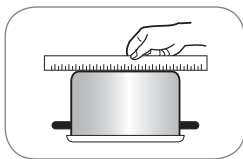

Avoiding Scratches

Use heavier gauge stainless steel cookware on your ceramic cooktop surface. This will help reduce the possibility of developing scratches on the ceramic surface.

Low-quality cookware can scratch the cooktop surface.

Cookware should always be lifted over the ceramic cooktop surface to prevent scratching. Over time, sliding ANY type of cookware over the ceramic cooktop may alter the overall appearance of the cooktop. Eventually, the buildup of scratches can make cleaning the surface difficult and degrade the overall appearance of the cooktop.

Scratches can also result from grains of sand (for example, after washing vegetables) which are dragged with the pot across the cooking surface.

Using Cookware

Always follow the recommendations for proper cookware type and size. In addition:

- Do not use dirty pans with grease buildup. Always use pans that are easy to clean after cooking, and make sure that the bottoms of the pans are clean and dry.
- When cooking with large amounts of liquid, use large pots so that nothing can boil over.
- Do not let pans boil dry. This may cause permanent damage in the form of breakage, fusion, or marring that can affect the ceramic cooktop. (This type of damage is not covered by your warranty.)
- Match the pan size and element to the amount of food being prepared.

Tips for Saving Energy

- Always position pots and pans before you switch on the element.
- Dirty elements and cookware use more electricity.
- Whenever possible, always have the lid firmly placed on the pots and pans so that they are completely covered.

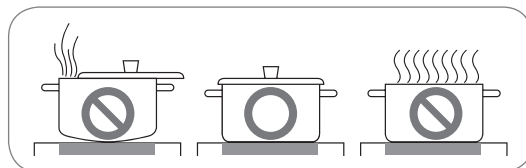

- Switch off the elements before the end of the cooking time to use the residual heat for keeping food warm or for melting.

- The base of the pot should be the same size as the element.

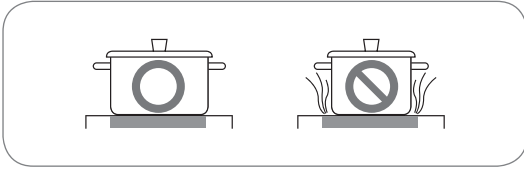

- Using a pressure cooker shortens cooking times by up to 50%.

Control Panel

Control Panel Features

Locations of Surface Elements and Controls

The surface burner elements are positioned in the same locations on the cooktop and the control panel for ease of use.

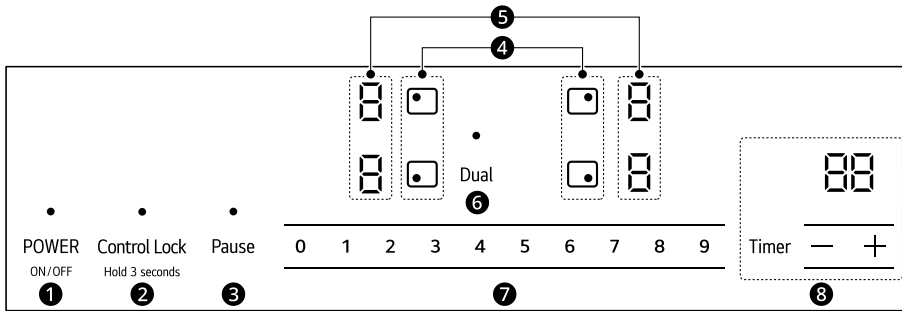

- ❶ POWER
- ❷ Control Lock
- ❸ Pause
- ❹ Cooking zone selectors
- ❺ Power level and residual heat indicators
- ❻ Dual selector
- ❼ Power level / Time selector
- ❽ Timer

Before Using the Cooktop

Before using the cooktop for the first time, clean it with a ceramic cooktop cleaner. This helps protect the top and makes cleanup easier. See Care and Cleaning.

⚠ CAUTION

- Never use abrasive scrubbing pads or cleaners. They can cause permanent damage to the cooktop surface.

Turning the Appliance On

Turn the cooktop on by pressing the **POWER** button for 1 second.

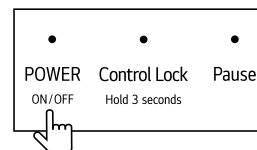

NOTE

- After you have pressed the Power button to turn on your cooktop, you must select an element and power level within approximately 20 seconds. Otherwise, the cooktop will switch itself off for safety reasons.

Select the Cooking Zone and Heat Setting

Single Element (Left Rear, Right Front, Right Rear)

- 1 To select the cooking zone, press the corresponding cooking zone's selector. "0" will blink on the selected cooking zone's indicator.

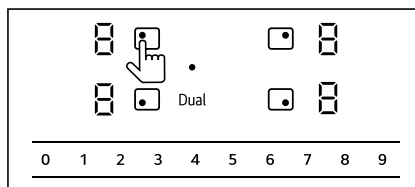

- 2 To set and adjust the power level, slide the **Power level / Time selector** left or right.

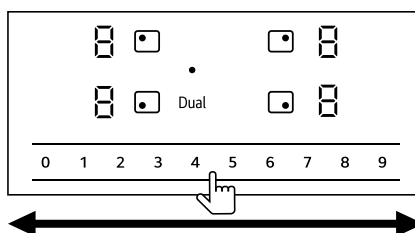

NOTE

- If you do not set the power level after selecting a cooking zone, the cooking zone turns off automatically after 7 seconds.
- If you set the power level to 0, the cooking zone will turn off after 3 seconds.

Dual Surface Unit (Left Front)

The dual surface unit features inner and outer elements. You can select either element depending on the cookware you are using.

- 1 To select the dual element cooking zone, press the left front cooking zone selector. "0" will blink on the selected cooking zone's indicator.
- 2 To set the dual element mode, press the **Dual selector** button. When the indicator turns on, the unit operates in Dual mode.

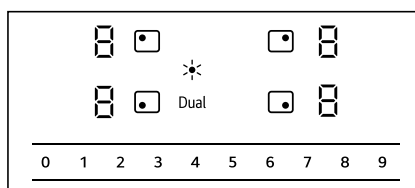

- 3 To set and adjust the power level, slide the **Power level / Time selector** left or right.

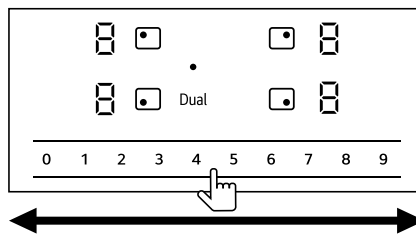

NOTE

- If you set the power level to 0, the cooking zone will turn off after 3 seconds.

Setting	Function	Used For
1-2	Warm-Melt	<ul style="list-style-type: none"> • Keeping food warm • Melting butter and chocolate
2-3	Simmering Braising	<ul style="list-style-type: none"> • Simmering rice dishes, soups and stews, pastas, and sauces • Braising smaller cuts of meat
3-4	Braising Reheating Steaming	<ul style="list-style-type: none"> • Braising larger cuts of meat • Reheating soups & stews • Steaming vegetables, chicken, and shellfish
4-5	Boiling Steaming General Cooking	<ul style="list-style-type: none"> • Cooking larger quantities of soups & stews • Steaming potatoes and vegetables • Cooking meat stocks or bouillon
5-6	Sauteing Sweating	<ul style="list-style-type: none"> • Sauteing sausages, frozen and stir fry vegetables • Sweating fresh carrots, celery, peppers, and onions
6-7	Roasting Light Fat Frying	<ul style="list-style-type: none"> • Roasting/Frying thin steaks & chops • Frying eggs, bacon, and pancakes
7-8	Heavy Browning Searing Deep Fat Frying	<ul style="list-style-type: none"> • Searing thick steaks and chops and browning meats • Frying bone-in fried chicken, French fries, battered fish/shellfish
8-9	Fast Heating Boiling	<ul style="list-style-type: none"> • Bringing water or liquids to a quick boil

NOTE

- Suggested cook settings are only a guide. Results may vary depending on the type of cookware being used on the cooking surface and/or the quantity of food being cooked. Adjust the settings as needed to achieve the desired results.

Pause

- 1 Press the **Pause** button for 1 second to pause cooking. All active cooking zones remain at power level 1 while cooking is paused.

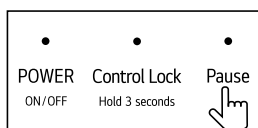

- 2 To resume cooking, press the **Pause** button for 1 second again. The cooking zones will resume cooking at the previous power level.

Turning the Appliance Off

- 1 To completely turn off the appliance, press and hold the **POWER** button.

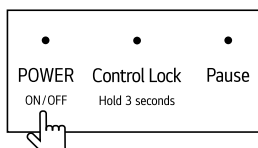

Turning the Cooking Zone Off

- 1 Press the desired **Cooking zone selector**.
- 2 Press the **Power level / Time selector** to set the power level to 0.

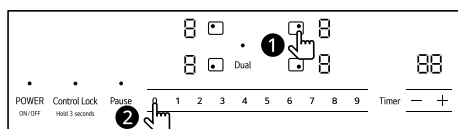

NOTE

- After you turn off a single cooking zone or the entire cooking surface, the hot surface indicators display an "H" on the appropriate cooking zones until the surface cools.

Using the Control Lock

Use the **Control Lock** function to help prevent a child from activating the cooking surface of the cooktop. It also prevents unintended setting

changes while cleaning the surface with a cloth by locking all buttons on the control panel except for the **POWER** button.

Switching the Control Lock On/Off

- 1 Press the **Control Lock** button for approximately 3 seconds. An audible signal sounds as confirmation.

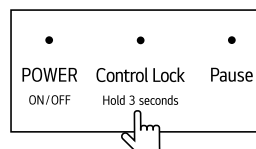

- 2 Press any control button. L will appear in the indicator, indicating the control lock has been activated.
- 3 To switch the control lock off, press the **Control Lock** button again for 3 seconds. An audible signal sounds as confirmation.

NOTE

- If you activate the control lock while the cooktop is operating, the **POWER** button remains active for safety, so you can turn the cooktop off.
- If the control lock is enabled when the cooktop is not operating, all buttons except for the **Control Lock** button will be disabled, including the **POWER** button.

Timer

- 1 Press the **Timer** button. The number 10 will be displayed above the timer indicator.

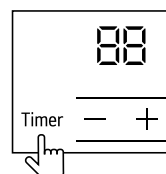

- 2 Press the +/- buttons to set the timer. Then, press the **Timer** button again.

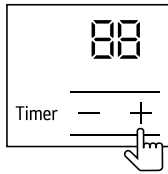

NOTE

- You can use the **Power level / Time selector** to set the timer. The **Power level / Time selector** is divided from 0 to 9, and you can press it to select the number. (The figure shows how to set 95 minutes.)

Press the **Power level / Time selector** once to select the tens digit of the timer, and then press again to select the units digit of the timer.

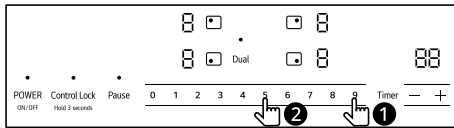

- To cancel the timer settings, hold down the Timer button for 3 seconds.

NOTE

- The timer can be set between 0 and 99 minutes.
- To change the settings more quickly, press and hold either the + or - button until the desired value is reached.
- When the timer ends, it sounds a beep 5 times. However, the cooking zone will not be turned off.

Power Management

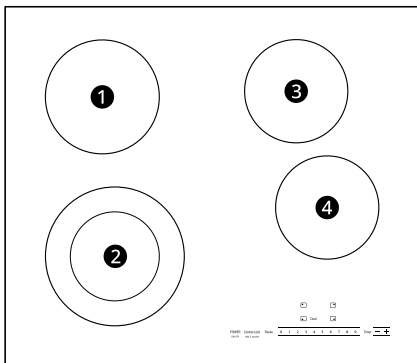

The cooking zones have maximum power available to them. If this power range is exceeded by using multiple cooking zones simultaneously, power

management automatically reduces the power level of cooking zones.

Each cooking zone has a different priority as shown.

Highest priority	-	-	Lower priority
2 in dual mode	4	2 in single mode	1, 3

The power level of the lower priority cooking zones might be limited depending on the power level of the higher priority cooking zones.

The display for this cooking zone alternates for some seconds between the set power level and the maximum possible power level. After that, the display changes from the set power level to the maximum possible power level.

Available maximum power levels on power management are as follows.

Case 1. Using 3 Cooking Zones

-	Priority of the Cooking Zone		
	1st	2nd	3rd
Power level	8 or 9	8 or 9	6
		7	7
		6	8 or 9
	7	8 or 9	7
		7	8 or 9
		6	9

Case 2. Using 4 Cooking Zones

-	Priority of the Cooking Zone			
	1st	2nd	3rd	4th
Power level	8 or 9	8 or 9	6	6
		7	7	7
			6	7
		6	8 or 9	6
			7	7
			6	8 or 9
	7	8 or 9	7	6
			6	7
		7	7	7
		6	8 or 9	7
			7	8 or 9
	6	7 or 8 or 9	8 or 9	6
			7	7
			6	8 or 9
		6	9	9

Setting the Mute

- 1 Turn the cooktop on by pressing the **POWER** button for 1 second.
- 2 With none of the elements operating, press the **Pause** button for 1 second to activate or deactivate the mute. $\square M$ or $\square F$ is displayed above the timer indicator.

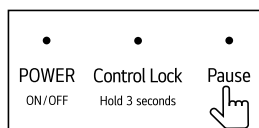

MAINTENANCE

Care and Cleaning

Make sure that the electrical power is off and all surfaces are cool before cleaning any part of the cooktop.

Cleaning the Cooktop

Normal Daily Use Cleaning

⚠ CAUTION

- If any sugar or food containing sugar spills, or plastic or foil melts on the cooktop, remove the material IMMEDIATELY with a metal razor scraper while the cooking surface is still hot to avoid the risk of damage to the glass-ceramic surface. When used correctly, the scraper will not damage the cooktop surface. For your safety, please use an oven mitt or pot holder while scraping the hot cooking surface.
- If water or food containing water spills, remove the spill IMMEDIATELY with a dry paper towel.
- Do not use scrub pads or abrasive cleaning pads. They may damage your cooktop surface.
- For your safety, wear an oven mitt or pot holder while cleaning the hot cooking surface.

Use ceramic cooktop cleaner on the glass cooktop. Other creams may not be as effective or may scratch, damage or stain the cooktop surface.

To maintain and protect the surface of the glass cooktop, follow these steps:

- 1** Before using the cooktop for the first time, clean it with a ceramic cooktop cleaner. This helps protect the top and makes cleanup easier.
- 2** Use ceramic cooktop cleaner regularly to help keep the cooktop looking new. Always allow the cooktop to cool before using ceramic cooktop cleaner.
- 3** Shake the cleaning cream well. Apply a few drops of cleaner directly to the cooktop.
- 4** Use a paper towel to clean the entire cooktop surface.

- 5** Rinse with clear water and use a dry cloth or paper towel to remove all cleaning residue.

NOTE

- Any damage or failure of the product resulting from the items below may not be covered under the LIMITED WARRANTY.
 - Sugary spillovers (such as preserves, ketchup, tomato sauce, jellies, fudge, candy, syrups, or chocolate) or melted plastics can cause pitting on the surface of your cooktop.
 - If food or water containing calcium (such as baking powder, wine, milk, spinach, or broccoli) is spilled on the cooktop, it can permanently stain or discolor the surface.

Burned-On Residue

- 1** While the cooktop is still warm, remove any burnt on deposits or spilled food from the glass-ceramic cooking surface with a suitable metal razor scraper. To prevent burns, wear an oven mitt or pot holder while using the metal scraper.

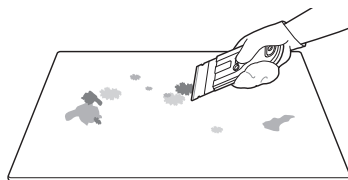

NOTE

- Do not use a dull or nicked blade.
- Hold the scraper at approximately a 30° angle to the cooktop.
- The razor scraper will not damage the markings on the cooking surface.

- 2** When the cooking surface has completely cooled, apply a few fingertip-sized dabs of a glass-ceramic cooktop cleaner in each burner area. Work the cleaning cream over the cooktop surface with a damp paper towel. Leave the cleaner on for 10 minutes before rinsing it off.

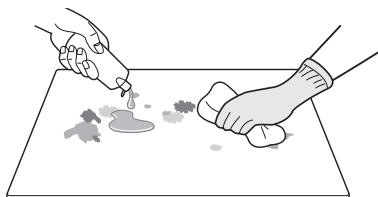

3 Rinse with clean water and wipe the cooktop surface with a clean, dry cloth.

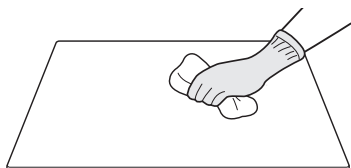

Maintaining the Cooktop

⚠ CAUTION

- Do not use chlorine bleach, ammonia, or other cleaners not specifically recommended for use on glass-ceramic cooktops.
- Let your glass-ceramic cooking surface cool off before cleaning.

	Wipe off with a damp towel and mild detergent	Use a metal scraper	Apply cooktop cleaning cream. Rub with a towel.	Rinse with a damp towel, then wipe dry.
Regular (Recommended after each use)				
Occasional (Recommended every week)				
Thorough (Recommended for tough stains or burnt-on food)				

NOTE

- For additional product information, visit our website at www.lg.com

- Do not use cookware if there is foreign matter on the cooktop surface. Always clean the cooktop surface before cooking.

Metal Marks and Scratches

⚠ CAUTION

- Cookware with rough or uneven bottoms can mark or scratch the cooktop surface.

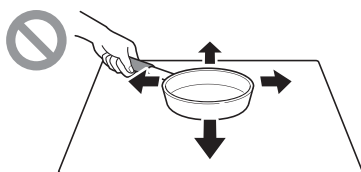

- Do not slide metal or glass across the cooktop surface.
- Do not use cookware with any dirt build-up on the bottom.

NOTE

- Any damage or failure of the product resulting from the items below may not be covered under the LIMITED WARRANTY.
 - Be careful not to slide pots and pans across the cooktop. Doing so will leave metal markings on the cooktop surface. To help remove these marks, use a ceramic cooktop cleaner with a cleaning pad for ceramic cooktops.
 - If pots with a thin overlay of aluminum or copper are allowed to boil dry, the overlay may leave a black discoloration on the cooktop. This should be removed immediately before heating again or the discoloration may be permanent.

TROUBLESHOOTING

Before Calling for Service

Before calling for service, review this list. It may save you time and expense. This list includes common occurrences that are not the result of a defect in workmanship or materials.

Troubleshooting

Problem	Possible Cause & Solution
The surface units will not maintain a rolling boil or will not cook fast enough.	You may be using inappropriate cookware. <ul style="list-style-type: none"> Use pans which are flat and match the diameter of the surface unit selected.
	In some areas, the power (voltage) may be low. <ul style="list-style-type: none"> Cover the pan with a lid until the desired heat is obtained.
The surface units will not turn on.	A fuse in your home may be blown or a circuit breaker may have tripped. <ul style="list-style-type: none"> Replace the fuse or reset the circuit breaker.
	The cooktop controls are set improperly. <ul style="list-style-type: none"> Check if the correct control is set for the surface unit you are using.
Areas of discoloration on the cooktop.	Food spillover was not cleaned. <ul style="list-style-type: none"> Refer to the Maintenance section.
	The surface is hot and the model features a light colored cooktop. <ul style="list-style-type: none"> This is normal. The surface may appear discolored when it is hot. This is temporary and will disappear as the glass cools.
The surface unit frequently cycles on and off.	The element will cycle on and off to maintain the power setting. <ul style="list-style-type: none"> This is normal operation, and not a system failure. Cycling at the high power setting is normal and can occur if the cookware is too small for the cooktop element or if the cookware bottom is not flat. Use the cooktop as usual.
The surface unit stops glowing when changed to a lower setting.	The unit is still on and hot. <ul style="list-style-type: none"> This is normal.
Scratches or abrasions on the cooktop surface.	The cooktop is being cleaned improperly. <ul style="list-style-type: none"> Scratches are not removable. Tiny scratches will become less visible in time as a result of cleaning. Use ceramic glass top cleaning cream. Do not use chemical or corrosive agents. These agents may damage the surface of the product.
	Cookware with rough bottoms was used on the cooktop or there were coarse particles (eg. salt or sand) present between the cookware and the surface of the cooktop. <ul style="list-style-type: none"> To avoid scratches, follow the recommended cleaning procedures. Make sure cookware bottoms are clean before use, and use cookware with smooth bottoms.
	Cookware has been slid across the cooktop surface. <ul style="list-style-type: none"> To avoid scratches, follow the recommended cleaning procedures. Make sure cookware bottoms are clean before use, and use cookware with smooth bottoms.
Brown streaks or specks.	Boilovers have been cooked onto the surface. <ul style="list-style-type: none"> Wait until the surface cools down. Then, use a single-edge razor-blade scraper at approximately a 45° angle against the glass surface to remove the soil. See the Maintenance section.

Problem	Possible Cause & Solution
Areas of discoloration with metallic sheen.	Mineral deposits from water and food have been left on the surface of the cooktop. <ul style="list-style-type: none">• Remove using a glass-ceramic cooktop cleaner.• Use cookware with clean, dry bottoms. Clean the cooktop with a ceramic cleaning agent regularly every week.
Cracking or "popping" sound.	This is the sound of the metal heating and cooling during cooking. <ul style="list-style-type: none">• This is normal operation and not a system failure. Use the cooktop as usual.

Error Codes

Error Code	Possible Cause & Solution
d0	<p>A button was touched for more than 8 seconds.</p> <ul style="list-style-type: none">• Clean moisture or foreign objects off the buttons. <p>If the problem continues, touch the Power button to restart the cooktop.</p> <p>If the problem is not solved after following these steps, call for service.</p>
F2	<p>The touch-enabled IC is communicating abnormally.</p> <ul style="list-style-type: none">• Restart the appliance using the Power button. If the problem continues, disconnect power for more than 30 seconds. Then, restart the appliance. If the problem is not solved after following these steps, call for service.
C3	<p>An element's sensor may not be working properly.</p> <ul style="list-style-type: none">• Cool the cooktop down until the error disappears. If the problem is not solved after following these steps, call for service.

LIMITED WARRANTY

USA

TERMS AND CONDITIONS

ARBITRATION NOTICE: THIS LIMITED WARRANTY CONTAINS AN ARBITRATION PROVISION THAT REQUIRES YOU AND LG ELECTRONICS (“LG”) TO RESOLVE DISPUTES BY BINDING ARBITRATION INSTEAD OF IN COURT, UNLESS YOU CHOOSE TO OPT OUT. IN ARBITRATION, CLASS ACTIONS AND JURY TRIALS ARE NOT PERMITTED. PLEASE SEE THE SECTION TITLED “PROCEDURE FOR RESOLVING DISPUTES” BELOW.

Should your LG Radiant Cooktop (“Product”) fail due to a defect in materials or workmanship under normal and proper use, during the warranty period set forth below, LG will, at its option, repair or replace the Product. This limited warranty is valid only to the original retail purchaser of the Product (“You”) and applies only when purchased lawfully and used within the United States including U.S. Territories.

Warranty Period	Scope of Warranty	HOW SERVICE IS HANDLED
One (1) year from date of original retail purchase	Parts and Labor (internal / functional parts only)	LG will provide, free of charge, all labor and in-home service to replace defective part(s).

- Replacement Products and parts are warranted for the remaining portion of the original warranty period or ninety (90) days, whichever is greater.
- Replacement Products and parts may be new, reconditioned, refurbished, or otherwise factory remanufactured.
- Replaced Product or part(s) will be the property of LG.
- Proof of original retail purchase specifying the Product model and date of purchase is required to obtain warranty service under this limited warranty.

EXCEPT TO THE EXTENT PROHIBITED BY APPLICABLE LAW, ANY IMPLIED WARRANTY OF MERCHANTABILITY OR FITNESS FOR A PARTICULAR PURPOSE ON THE PRODUCT IS LIMITED IN DURATION TO THE DURATION OF THE ABOVE LIMITED WARRANTY. UNDER NO CIRCUMSTANCES SHALL LG OR ITS U.S. DISTRIBUTORS/DEALERS BE LIABLE FOR ANY INDIRECT, INCIDENTAL, CONSEQUENTIAL, SPECIAL, OR PUNITIVE DAMAGES, INCLUDING, WITHOUT LIMITATION, LOST GOODWILL, LOST REVENUES OR PROFITS, WORK STOPPAGE, IMPAIRMENT OF OTHER GOODS, COST OF REMOVAL AND REINSTALLATION OF THE PRODUCT, LOSS OF USE, OR ANY OTHER DAMAGES WHETHER BASED IN CONTRACT, TORT, OR OTHERWISE. LG’S TOTAL LIABILITY, IF ANY, SHALL NOT EXCEED THE PURCHASE PRICE PAID BY YOU FOR THE PRODUCT.

SOME STATES DO NOT ALLOW THE EXCLUSION OR LIMITATION OF INCIDENTAL OR CONSEQUENTIAL DAMAGES OR LIMITATIONS ON HOW LONG AN IMPLIED WARRANTY LASTS, SO THE ABOVE EXCLUSIONS OR LIMITATIONS MAY NOT APPLY TO YOU. THIS LIMITED WARRANTY GIVES YOU SPECIFIC LEGAL RIGHTS AND YOU MAY ALSO HAVE OTHER RIGHTS THAT VARY FROM STATE TO STATE.

THIS LIMITED WARRANTY DOES NOT COVER:

- Service trips to deliver, pick up, or install, educate how to operate, correct wiring, or correct unauthorized repairs.
- Damage or failure of the Product to perform during power failures and interrupted or inadequate electrical service.
- Damage or failure of the Product caused by leaky or broken water pipes, frozen water pipes, restricted drain lines, inadequate or interrupted water supply or inadequate supply of air.
- Damage or failure of the Product resulting from operating the Product in a corrosive atmosphere or contrary to the Product owner’s manual.
- Damage or failure of the Product caused by accidents, pests and vermin, lightning, wind, fire, floods, acts of nature, or any other causes beyond the control of LG.

30 LIMITED WARRANTY

- Damage or failure of the Product caused by unauthorized modification or alteration, or if the Product is used for other than the intended purpose, or any water leakage where the Product was not properly installed.
- Damage or failure of the Product caused by incorrect electrical current, voltage, or plumbing codes.
- Damage or failure of the Product caused by transportation, storage, and/or handling, including scratches, dents, chips, and/or other damage to the finish of the Product, unless such damage is reported within one (1) week of delivery.
- Damage or failure of the Product resulting from misuse, abuse, improper installation, repair, or maintenance. Improper repair includes the use of parts not authorized by LG. Improper installation or maintenance includes installation or maintenance contrary to the Product owner's manual.
- Damage or failure of the Product caused by the use of parts, components, accessories, consumable cleaning products, or any other products or services that were not authorized by LG.
- Damage or missing items to any display or open box Product.
- Refurbished Product or any Product sold "As Is", "Where Is", "With all Faults", or similar disclaimer.
- Products with original serial numbers that have been removed, altered, or cannot be readily determined.
- Increases in utility costs and additional utility expenses.
- Any noises associated with normal operation.
- Products used for other than normal and proper household use (e.g., commercial or industrial use) or contrary to the Product owner's manual.
- Costs associated with removal and reinstallation of the Product for repairs, or the removal and reinstallation of the Product if it is installed in an inaccessible location or not installed in accordance with the Product Owner's manual.
- Accessories, removable components, or consumable parts (e.g. Shelves, door bins, drawers, water/air filters, racks, light bulbs, batteries, etc., as applicable), except for internal/functional parts covered under this limited warranty.

The cost of repair or replacement under these excluded circumstances shall be borne by You.

TO OBTAIN WARRANTY SERVICE AND ADDITIONAL INFORMATION

Call [1-800-243-0000](tel:1-800-243-0000) and select the appropriate option from the menu.

Or visit our website at <http://www.lg.com>

Or by mail: LG Electronics Customer Service P.O. Box 240007 Huntsville, AL 35813 ATTN: CIC

PROCEDURE FOR RESOLVING DISPUTES:

ALL DISPUTES BETWEEN YOU AND LG ARISING OUT OF OR RELATING IN ANY WAY TO THIS LIMITED WARRANTY OR THE PRODUCT SHALL BE RESOLVED EXCLUSIVELY THROUGH BINDING ARBITRATION, AND NOT IN A COURT OF GENERAL JURISDICTION. BINDING ARBITRATION MEANS THAT YOU AND LG ARE EACH WAIVING THE RIGHT TO A JURY TRIAL AND TO BRING OR PARTICIPATE IN A CLASS ACTION.

Definitions. For the purposes of this section, references to "LG" mean LG Electronics U.S.A., Inc., its parents, subsidiaries and affiliates, and each of their officers, directors, employees, agents, beneficiaries, predecessors in interest, successors, assigns and suppliers; references to "dispute" or "claim" shall include any dispute, claim or controversy of any kind whatsoever (whether based in contract, tort, statute, regulation, ordinance, fraud, misrepresentation or any other legal or equitable theory) arising out of or relating in any way to the sale, condition or performance of the product or this Limited Warranty.

Notice of Dispute. In the event you intend to commence an arbitration proceeding, you must first notify LG in writing at least 30 days in advance of initiating the arbitration by sending a letter to LG at LG Electronics, USA, Inc. Attn: Legal Department- Arbitration 111 Sylvan Avenue, Englewood Cliffs, NJ 07632. You and LG agree to engage in good faith discussions in an attempt to amicably resolve your claim. The notice must provide your name, address, and telephone number; identify the product that is the subject of the claim; and describe the nature of the claim and the relief being sought. If you and LG are unable to resolve the dispute within 30 days, either party may proceed to file a claim for arbitration.

Agreement to Binding Arbitration and Class Action Waiver. Upon failure to resolve the dispute during the 30 day period after sending written notice to LG, you and LG agree to resolve any claims between us only by binding arbitration on an individual basis, unless you opt out as provided below. Any dispute between you and LG shall not be combined or consolidated with a dispute involving any other person's or entity's product or claim. More specifically, without limitation of the foregoing, any dispute between you and LG shall not under any circumstances proceed as part of a class or representative action. Instead of arbitration, either party may bring an individual action in small claims court, but that small claims court action may not be brought on a class or representative basis.

Arbitration Rules and Procedures. To begin arbitration of a claim, either you or LG must make a written demand for arbitration. The arbitration will be administered by the American Arbitration Association ("AAA") and will be conducted before a single arbitrator under the AAA's Consumer Arbitration Rules that are in effect at the time the arbitration is initiated (referred to as the "AAA Rules") and under the procedures set forth in this section. The AAA Rules are available online at www.adr.org/consumer. Send a copy of your written demand for arbitration, as well as a copy of this provision, to the AAA in the manner described in the AAA Rules. You must also send a copy of your written demand to LG at LG Electronics, USA, Inc. Attn: Legal Department- Arbitration 111 Sylvan Avenue, Englewood Cliffs, NJ 07632. If there is a conflict between the AAA Rules and the rules set forth in this section, the rules set forth in this section will govern. This arbitration provision is governed by the Federal Arbitration Act. Judgment may be entered on the arbitrator's award in any court of competent jurisdiction. All issues are for the arbitrator to decide, except that issues relating to the scope and enforceability of the arbitration provision and to the arbitrability of the dispute are for the court to decide. The arbitrator is bound by the terms of this provision.

Governing Law. The law of the state of your residence shall govern this Limited Warranty and any disputes between us except to the extent that such law is preempted by or inconsistent with applicable federal law.

Fees/Costs. You do not need to pay any fee to begin an arbitration. Upon receipt of your written demand for arbitration, LG will promptly pay all arbitration filing fees to the AAA unless you seek more than \$25,000 in damages, in which case the payment of these fees will be governed by the AAA Rules. Except as otherwise provided for herein, LG will pay all AAA filing, administration and arbitrator fees for any arbitration initiated in accordance with the AAA Rules and this arbitration provision. If you prevail in the arbitration, LG will pay your attorneys' fees and expenses as long as they are reasonable, by considering factors including, but not limited to, the purchase amount and claim amount. Notwithstanding the foregoing, if applicable law allows for an award of reasonable attorneys' fees and expenses, an arbitrator can award them to the same extent that a court would. If the arbitrator finds either the substance of your claim or the relief sought in the demand is frivolous or brought for an improper purpose (as measured by the standards set forth in Federal Rule of Civil Procedure 11(b)), then the payment of all arbitration fees will be governed by the AAA Rules. In such a situation, you agree to reimburse LG for all monies previously disbursed by it that are otherwise your obligation to pay under the AAA Rules. Except as otherwise provided for, LG waives any rights it may have to seek attorneys' fees and expenses from you if LG prevails in the arbitration.

Hearings and Location. If your claim is for \$25,000 or less, you may choose to have the arbitration conducted solely on the basis of (1) documents submitted to the arbitrator, (2) through a telephonic hearing, or (3) by an in-person hearing as established by the AAA Rules. If your claim exceeds \$25,000, the right to a hearing will be determined by the AAA Rules. Any in-person arbitration hearings will be held at a location within the federal judicial district in which you reside unless we both agree to another location or we agree to a telephonic arbitration.

Opt Out. You may opt out of this dispute resolution procedure. If you opt out, neither you nor LG can require the other to participate in an arbitration proceeding. To opt out, you must send notice to LG no later than 30 calendar days from the date of the first consumer purchaser's purchase of the product by either: (i) sending an e-mail to optout@lge.com, with the subject line: "Arbitration Opt Out" or (ii) calling 1-800-980-2973. You must include in the opt out e-mail or provide by telephone: (a) your name and address; (b) the date on which the product was purchased; (c) the product model name or model number; and (d) the serial number (the serial number can be found (i) on the product; or (ii) online by accessing <https://www.lg.com/us/support/repair-service/schedule-repair-continued> and clicking on "Find My Model & Serial Number").

You may only opt out of the dispute resolution procedure in the manner described above (that is, by e-mail or telephone); no other form of notice will be effective to opt out of this dispute resolution procedure.

32 LIMITED WARRANTY

Opting out of this dispute resolution procedure will not affect the coverage of the Limited Warranty in any way, and you will continue to enjoy the full benefits of the Limited Warranty. If you keep this product and do not opt out, then you accept all terms and conditions of the arbitration provision described above.

CANADA

TERMS AND CONDITIONS

ARBITRATION NOTICE: THIS LIMITED WARRANTY CONTAINS AN ARBITRATION PROVISION THAT REQUIRES YOU AND LG TO RESOLVE DISPUTES BY BINDING ARBITRATION INSTEAD OF IN COURT, UNLESS THE LAWS OF YOUR PROVINCE OR TERRITORY DO NOT PERMIT THAT, OR, IN OTHER JURISDICTIONS, IF YOU CHOOSE TO OPT OUT. FOR FURTHER CLARITY, THIS ARBITRATION PROVISION IS NOT APPLICABLE TO CUSTOMERS RESIDING IN ONTARIO. IN ARBITRATION, CLASS ACTIONS AND JURY TRIALS ARE NOT PERMITTED. PLEASE SEE THE SECTION TITLED "PROCEDURE FOR RESOLVING DISPUTES" BELOW.

Should your LG Radiant Cooktop ("Product") fail due to a defect in materials or workmanship under normal and proper use, during the warranty period set forth below, LG Electronics Canada, Inc. ("LGECI") will, at its option, repair, replace or pro rate the Product upon receipt of proof of the original retail purchase. This limited warranty is valid only to the original retail purchaser of the Product and applies only to a Product distributed, purchased from an authorized retailer and used within Canada, as determined at the sole discretion of LGECI.

WARRANTY PERIOD: (Note: If the original date of purchase cannot be verified, the warranty will begin sixty (60) days from the date of manufacture).
Parts and Labor (internal/functional parts only)
One (1) year from the date of original retail purchase

- Replacement products and parts are warranted for the remaining portion of the original warranty period or ninety (90) days, whichever is greater.
- Replacement products and parts may be new, reconditioned, refurbished, or otherwise factory remanufactured, all at the sole discretion of LGECI.
- Proof of original retail purchase specifying the Product model and date of purchase is required to obtain warranty service under this Limited Warranty.

LGECI'S SOLE LIABILITY IS LIMITED TO THE LIMITED WARRANTY SET OUT ABOVE, UNLESS SUCH LIMITATION IS PROHIBITED BY THE LAWS OF THE PROVINCE IN WHICH YOU RESIDE. EXCEPT AS EXPRESSLY PROVIDED ABOVE, OR IF OTHERWISE PROHIBITED BY THE LAW OF THE PROVINCE IN WHICH YOU RESIDE, LGECI DOES NOT MAKE ANY OTHER WARRANTIES OR CONDITIONS RESPECTING THE PRODUCT, AND HEREBY DISCLAIMS, ALL OTHER WARRANTIES AND CONDITIONS RESPECTING THE PRODUCT, WHETHER EXPRESS OR IMPLIED, INCLUDING BUT NOT LIMITED TO, ANY IMPLIED WARRANTY OR CONDITION OF MERCHANTABILITY OR FITNESS FOR A PARTICULAR PURPOSE, AND NO REPRESENTATIONS SHALL BE BINDING ON LGECI. LGECI DOES NOT AUTHORIZE ANY PERSON TO CREATE OR ASSUME FOR IT ANY OTHER WARRANTY OBLIGATION OR LIABILITY IN CONNECTION WITH THE PRODUCT. TO THE EXTENT THAT ANY WARRANTY OR CONDITION IS IMPLIED BY LAW, IT IS LIMITED TO THE WARRANTY PERIOD SET OUT ABOVE. UNDER NO CIRCUMSTANCES SHALL LGECI, THE MANUFACTURER OR DISTRIBUTOR OF THE PRODUCT, BE LIABLE FOR ANY INCIDENTAL, CONSEQUENTIAL, SPECIAL, DIRECT, INDIRECT, PUNITIVE OR EXEMPLARY DAMAGES, INCLUDING, WITHOUT LIMITATION, LOSS OF GOODWILL, LOST PROFITS, LOSS OF ANTICIPATED PROFITS, LOST REVENUE, LOSS OF USE, OR ANY OTHER DAMAGE, WHETHER ARISING DIRECTLY OR INDIRECTLY FROM ANY CONTRACTUAL BREACH, FUNDAMENTAL BREACH, TORT OR OTHERWISE, OR FROM ANY ACTS OR OMISSIONS. LGECI'S TOTAL LIABILITY, IF ANY, SHALL NOT EXCEED THE PURCHASE PRICE PAID BY YOU FOR THE PRODUCT.

This Limited Warranty gives you specific legal rights. You may also have other rights that vary from province to province depending on applicable provincial laws. Any term of this Limited Warranty that negates or varies any implied condition or warranty under provincial law is severable where it conflicts with such provincial law without affecting the remainder of this warranty's terms.

THIS LIMITED WARRANTY DOES NOT COVER:

- Service trips to i) deliver, pick up, or install or; educate on how to operate the Product; ii) correct wiring or plumbing; or iii) correct unauthorized repairs or installations of the Product;
- Damage or failure of the Product to perform during power failures and interrupted or inadequate electrical service;
- Damage or failure caused by leaky or broken water pipes, frozen water pipes, restricted drain lines, inadequate or interrupted water supply or inadequate supply of air;
- Damage or failure resulting from operating the Product in a corrosive atmosphere or contrary to the instructions outlined in the Product's owner's manual;
- Damage or failure to the Product caused by accidents, pests and vermin, lightning, wind, fire, floods, acts of God, or any other causes beyond the control of LGECI or the manufacturer;
- Damage or failure resulting from misuse, abuse, improper installation, repair, or maintenance of the Product. Improper repair includes use of parts not authorized or specified by LGECI. Improper installation or maintenance includes installation or maintenance contrary to the Product's owner's manual;
- Damage or failure caused by unauthorized modification or alteration of the Product, or if used for other than the intended household purpose/use of the Product, or damage or failure resulting from any water leakage due to improper installation of the Product;
- Damage or failure caused by incorrect electrical current, voltage or plumbing codes;
- Damage or failure caused by use that is other than normal household use, including, without limitation, commercial or industrial use, including use in commercial offices or recreational facilities, or as otherwise outlined in the Product's owner's manual;
- Damage or failure caused by the use of any accessories, components or cleaning products, including, without limitation, water filters, that are not approved/authorized by LGECI;
- Damage or failure caused by transportation and handling, including scratches, dents, chips and/or other damage to the finish of the Product, unless such damage results from defects in materials or workmanship and is reported to LGECI within one (1) week of delivery of the Products;
- Damage or missing items to any display, open box, refurbished or discounted Product;
- Refurbished Product or any Product sold "As Is", "Where Is", "With all Faults", or any similar disclaimer;
- Products with original serial numbers that have been removed, altered or cannot be readily determined at the discretion of LGECI;
- Increases in utility costs and additional utility expenses in any way associated with the Product;
- Any noises associated with normal operation of the Product;
- Replacement of any part that was not originally included with the Product;
- Replacement of light bulbs, filters, fuses or any other consumable parts;
- Costs associated with removal and/or reinstallation of the Product for repairs; and
- Shelves, door bins, drawers, handle and accessories to the Product, except for internal/functional parts covered under this Limited Warranty.
- Coverage for "in Home" repairs, for products in-warranty, will be provided if the Product is within a 150 km radius from the nearest authorized service center (ASC), as determined by LG Canada. If your Product is located outside a 150 km radius from a ASC, as determined by LG Canada, it will be your responsibility to bring the Product, at your sole expense, to the ASC for in-warranty repair.

All costs and expenses associated with the above excluded circumstances, listed under the heading, This Limited Warranty Does Not Cover, shall be borne by the consumer.

TO OBTAIN WARRANTY SERVICE AND ADDITIONAL INFORMATION, PLEASE CALL OR VISIT OUR WEBSITE:

Call [1-888-542-2623](tel:1-888-542-2623) (7 A.M. to 12 A.M., 365 days a year) and select the appropriate option from the menu, or visit our website at <http://www.lg.com>

PROCEDURE FOR RESOLVING DISPUTES:

EXCEPT WHERE PROHIBITED BY LAW, ALL DISPUTES BETWEEN YOU AND LG ARISING OUT OF OR RELATING IN ANY WAY TO THIS LIMITED WARRANTY OR THE PRODUCT SHALL BE RESOLVED EXCLUSIVELY THROUGH BINDING ARBITRATION, AND NOT IN A COURT OF GENERAL JURISDICTION. EXCEPT WHERE PROHIBITED AT LAW, YOU AND LG BOTH IRREVOCABLY AGREE TO WAIVE THE RIGHT TO A JURY TRIAL AND TO BRING OR PARTICIPATE IN A CLASS ACTION. FOR CLARITY, THIS PROVISION DOES NOT APPLY TO CONSUMERS RESIDING IN ONTARIO.

Definitions. For the purposes of this section, references to “LG” mean LG Electronics Canada, Inc., its parents, subsidiaries and affiliates, and each of their officers, directors, employees, agents, beneficiaries, predecessors in interest, successors, assigns and suppliers; references to “dispute” or “claim” shall include any dispute, claim or controversy of any kind whatsoever (whether based in contract, tort, statute, regulation, ordinance, fraud, misrepresentation or any other legal or equitable theory) arising out of or relating in any way to the sale, condition or performance of the product or this Limited Warranty.

Notice of Dispute. In the event you intend to commence an arbitration proceeding, you must first notify LG in writing at least 30 days in advance of initiating the arbitration by sending a letter to LGECI Legal Team at 20 Norelco Drive, North York, Ontario, Canada M9L 2X6 (the “Notice of Dispute”). You and LG agree to engage in good faith discussions in an attempt to amicably resolve your claim. The notice must provide your name, address, and telephone number; identify the product that is the subject of the claim; and describe the nature of the claim and the relief being sought. If you and LG are unable to resolve the dispute within 30 days of LG’s receipt of the Notice of Dispute, the dispute shall be resolved by binding arbitration in accordance with the procedure set out herein. You and LG both agree that, during the arbitration proceeding, the terms (including any amount) of any settlement offer made by either you or LG will not be disclosed to the arbitrator until the arbitrator determines the dispute.

Agreement to Binding Arbitration and Class Action Waiver. Upon failure to resolve the dispute during the 30 day period after LG’s receipt of the Notice of Dispute, you and LG agree to resolve any claims between you and LG only by binding arbitration on an individual basis, unless you opt out as provided below, or you reside in a jurisdiction that prevents full application of this clause in the circumstances of the claims at issue (in which case if you are a consumer, this clause will only apply if you expressly agree to the arbitration). To the extent permitted by applicable law, any dispute between you and LG shall not be combined or consolidated with a dispute involving any other person’s or entity’s product or claim. More specifically, without limitation of the foregoing, except to the extent such a prohibition is not permitted at law, any dispute between you and LG shall not under any circumstances proceed as part of a class or representative action. Instead of arbitration, either party may bring an individual action in small claims court, but that small claims court action may not be brought on a class or representative basis except to the extent this prohibition is not permitted at law in your province or territory of jurisdiction as it relates to the claims at issue between you and LG. This does not apply to consumers in Ontario. In accordance with provincial legislation, the consumer and LG may agree to resolve the dispute using any procedure available, including commencing the action in the Superior Court of Justice.

Arbitration Rules and Procedures. To begin arbitration of a claim, either you or LG must make a written demand for arbitration. The arbitration will be private and confidential, and conducted on a simplified and expedited basis before a single arbitrator chosen by the parties under the provincial or territorial commercial arbitration law and rules of the province or territory of your residence. You must also send a copy of your written demand to LG at LG Electronics, Canada, Inc., Attn: Legal Department- Arbitration, 20 Norelco Drive, North York, Ontario M9L 2X6. This arbitration provision is governed by your applicable provincial or territorial commercial arbitration legislation. For consumers in Ontario, the applicable arbitration legislation only applies if consumers agree to submit the dispute to arbitration. Judgment may be entered on the arbitrator’s award in any court of competent jurisdiction. All issues are for the arbitrator to decide, except that, issues relating to the scope and enforceability of the arbitration provision and to the arbitrability of the dispute are for the court to decide. The arbitrator is bound by the terms of this provision.

Governing Law. The law of the province or territory of your purchase shall govern this Limited Warranty and any disputes between you and LG except to the extent that such law is preempted by or inconsistent with applicable federal or provincial/territorial law. Should arbitration not be permitted for any claim, action, dispute or controversy between you and LG, you and LG attorn to the exclusive jurisdiction of the courts of the province or territory of your purchase for the resolution of the claim, action, dispute or controversy between you and LG.

Fees/Costs. You do not need to pay any fee to begin an arbitration. Upon receipt of your written demand for arbitration, LG will promptly pay all arbitration filing fees unless you seek more than \$25,000 in damages, in which case the payment of these fees will be governed by the applicable arbitration rules. Except as otherwise provided for herein, LG will pay all filing, administration and arbitrator fees for any arbitration initiated in accordance with the applicable arbitration rules and this arbitration provision. If you prevail in the arbitration, LG will pay your attorneys' fees and expenses as long as they are reasonable, by considering factors including, but not limited to, the purchase amount and claim amount. Notwithstanding the foregoing, if applicable law allows for an award of reasonable attorneys' fees and expenses, an arbitrator can award them to the same extent that a court would. If the arbitrator finds either the substance of your claim or the relief sought in the demand is frivolous or brought for an improper purpose (as measured by the applicable laws), then the payment of all arbitration fees will be governed by the applicable arbitration rules. In such a situation, you agree to reimburse LG for all monies previously disbursed by it that are otherwise your obligation to pay under the applicable arbitration rules. Except as otherwise provided for, LG waives any rights it may have to seek attorneys' fees and expenses from you if LG prevails in the arbitration.

Hearings and Location. If your claim is for \$25,000 or less, you may choose to have the arbitration conducted solely (1) on the basis of documents submitted to the arbitrator, (2) through a telephonic hearing, or (3) by an in-person hearing as established by the applicable arbitration rules. If your claim exceeds \$25,000, the right to a hearing will be determined by the applicable arbitration rules. Any in-person arbitration hearings will be held at the nearest, most mutually-convenient arbitration location available within the province or territory in which you reside unless you and LG both agree to another location or agree to a telephonic arbitration.

Severability and Waiver. If any portion of this Limited Warranty (including these arbitration procedures) is unenforceable, the remaining provisions will continue in full force and effect to the maximum extent permitted by applicable law. Should LG fail to enforce strict performance of any provision of this Limited Warranty (including these arbitration procedures), it does not mean that LG intends to waive or has waived any provision or part of this Limited Warranty.

Opt Out. The arbitration provision requires you and LG to resolve disputes by binding arbitration instead of court, unless the laws of your province or territory do not permit that, or, in other jurisdictions, if you choose to opt out. The arbitration provision does not apply to consumers in Ontario.

For individuals that fall within the binding arbitration provisions, you may opt out of this dispute resolution procedure. If you opt out, neither you nor LG can require the other to participate in an arbitration proceeding. To opt out, you must send notice to LG no later than 30 calendar days from the date of the first consumer purchaser's purchase of the product by either (i) sending an e-mail to optout@lge.com, with the subject line: "Arbitration Opt Out;" or (ii) calling 1-800-980-2973. You must include in the opt out e-mail or provide by telephone: (a) your name and address; (b) the date on which the product was purchased; (c) the product model name or model number; and (d) the serial number (the serial number can be found (i) on the product; or (ii) online by accessing https://www.lg.com/ca_en/findmodel_serial/).

In the event that you "Opt Out", the law of the province or territory of your residence shall govern this Limited Warranty and any disputes between you and LG except to the extent that such law is preempted by or inconsistent with applicable federal or provincial/territorial law. Should arbitration not be permitted for any claim, action, dispute or controversy between you and LG, you and LG agree to attorn to the exclusive jurisdiction of the courts of the province or territory of your residence for the resolution of the claim, action, dispute or controversy between you and LG.

You may only opt out of the dispute resolution procedure in the manner described above (that is, by e-mail or telephone); no other form of notice will be effective to opt out of this dispute resolution procedure. Opting out of this dispute resolution procedure will not affect the coverage of the Limited Warranty in any way, and you will continue to enjoy the full benefits of the Limited Warranty. If you keep this product and do not opt out, then you accept all terms and conditions of the arbitration provision described above.

Conflict of Terms. In the event of a conflict or inconsistency between the terms of this Limited Warranty and the End User License Agreement ("EULA") in regards to dispute resolution, the terms of this Limited Warranty shall control and govern the rights and obligations of the parties and shall take precedence over the EULA.



LG Customer Information Center

For inquiries or comments, visit **www.lg.com** or call:

1-800-243-0000 U.S.A.

1-888-542-2623 CANADA

Register your product Online!

www.lg.com

Centro de Información al Cliente LG

Para consultas o comentarios, visite **www.lg.com** o llame por teléfono:

1-800-243-0000 EE.UU.

1-888-542-2623 CANADÁ

¡Registre su producto en línea!

www.lg.com

Centre de Service à la Clientèle de LG

Pour des questions ou des commentaires, visitez **www.lg.com/ca_fr** ou appelez :

1-800-243-0000 ÉTATS-UNIS

1-888-542-2623 CANADA

Enregistrez votre produit en ligne!

www.lg.com/ca_fr