



OWNER'S MANUAL

COOKTOP

Read this owner's manual thoroughly before operating the appliance and keep it handy for reference at all times.

ENGLISH

CBIS3018BE



MFL72051004
Rev.00_MMDDYY

www.lg.com

Copyright © 2010-2018 LG Electronics. All Rights Reserved

2

TABLE OF CONTENTS

3 IMPORTANT SAFETY INSTRUCTIONS

- 3 READ ALL INSTRUCTIONS BEFORE USE
- 3 WARNING STATEMENTS
- 7 CAUTION STATEMENTS

9 PRODUCT OVERVIEW

- 9 Product Features

10 INSTALLATION

- 10 Before Installing
- 14 Installing the Cooktop

17 OPERATION

- 17 Introduction to Induction Cooking
- 17 Cookware
- 20 Control Panel

32 SMART FUNCTIONS

- 32 LG ThinQ Application

35 MAINTENANCE

- 35 Care and Cleaning

37 TROUBLESHOOTING

- 37 Before Calling for Service

40 LIMITED WARRANTY

- 40 USA
- 44 CANADA

IMPORTANT SAFETY INSTRUCTIONS

READ ALL INSTRUCTIONS BEFORE USE

Safety Messages

Your safety and the safety of others are very important.

We have provided many important safety messages in this manual and on your appliance. Always read and follow all safety messages.

Download this owner's manual at <http://www.lg.com>



This is the safety alert symbol.

This symbol alerts you to potential hazards that can kill or injure you and others. All safety messages will follow the safety alert symbol and either the word WARNING or CAUTION.

These words mean:



WARNING

You may be killed or seriously injured if you do not follow instructions.



CAUTION

You may be injured or cause damage to the product if you do not follow instructions.

All safety messages will tell you what the potential hazard is, tell you how to reduce the chance of injury, and tell you what may happen if the instructions are not followed.

WARNING STATEMENTS

WARNING

- To reduce the risk of explosion, fire, death, electric shock, scalding or injury to persons when using this product, follow basic precautions, including the following:

Installation

- Be sure your appliance is properly installed and grounded by a qualified technician in accordance with the National Electrical Code ANSI/NFPA No. 70, latest edition in the United States, and all local code requirements. Install only per installation instructions.
- The safety aspects of this appliance comply with accepted technical standards.
- Never modify or alter the construction of an appliance such as removal of panels, wire covers or any other permanent part of the product.
- Remove all tape and packaging wrap before using the appliance. Destroy the carton and plastic bags after unpacking the appliance. Never allow children to play with packaging material.
- The installation and connection of the new appliance must only be carried out by qualified personnel.

Operation

- Know how to disconnect the electrical power to the appliance at the circuit breaker or fuse box in case of an emergency. Mark the breaker or fuse for ease of identification and swift action if necessary.
- Never use your appliance for warming or heating a room.
- Persons with a pacemaker or similar medical device should exercise caution using or standing near an induction unit while it is in operation, as the electromagnetic field may affect the working of the

4 IMPORTANT SAFETY INSTRUCTIONS

pacemaker or similar medical device. It would be advisable to consult your doctor or the pacemaker or medical device manufacturer about your particular situation.

- DO NOT touch cooking zones or areas near these surfaces. Cooking zones may be hot from residual heat even though they are dark in color. Areas near the cooking zones may become hot enough to cause burns. During and after use, do not touch, or let clothing or other flammable materials touch, these areas until they have had sufficient time to cool.
- Never wear loose fitting or hanging garments while using this appliance.
- Always turn off all controls when cooking is completed.
- Do not use water or flour on grease fires. Smother the fire with a pan lid, or use baking soda or a dry chemical or foam-type extinguisher.
- Use only dry pot holders. Moist or damp pot holders on hot surfaces may result in burns from steam. Do not let pot holders touch hot surface units. Do not use a towel or other bulky cloth instead of a pot holder.
- Do not heat unopened food containers. A buildup of pressure may cause the container to burst and result in injury.
- Flammable materials should not be stored near or on the cooking surface. This includes paper, plastic and cloth items, such as cookbooks, plasticware and towels, as well as flammable liquids. Do not store explosives, such as aerosol cans, on or near the appliance. Flammable materials may explode and result in fire or property damage.
- Do not store or use gasoline or other flammable vapors and liquids in the vicinity of this or any other appliance.
- Never place combustible items on the cooktop.
- Never keep any combustible items or aerosol cans in a drawer located under the cooktop.
- When heating fat or grease, watch it closely. Fat or grease may catch fire if allowed to become too hot.
- Overheated fats and oils catch fire quickly. You should supervise cooking when preparing foods in fat or oil.
- Use a deep fat thermometer, if possible, to prevent overheating fat beyond the smoking point.
- If the surface is cracked, switch off the appliance to avoid the possibility of electric shock. Do not reuse your cooktop until the glass surface has been replaced.
- When using the cooktop, never use aluminum foil, products wrapped in aluminum foil, or deep-frozen food in aluminum cookware.
- This appliance is not intended for use by young children or infirm persons unless they have been adequately supervised by a responsible person to ensure that they can use the appliance safely.
- Young children should be supervised to ensure that they do not play with the appliance.
- Accessible parts may become hot during use. Young children should be kept away.
- Items of interest to children should not be stored in cabinets above a cooktop or on the backsplash of a cooktop – children climbing on the cooktop to reach items could be seriously injured.
- Children should not be left alone or unattended in the area where an appliance is in use. They should never be allowed to sit or stand on any part of the appliance.
- Take care when plugging in electric appliances near the cooktop. Cords must not come into contact with the hot surface. Doing so could cause damage to the cooktop and cable insulation.
- After use, switch off the cooktop element by its control and do not rely on the pan detector.
- Avoid placing metal objects such as knives, forks, spoons and lids on the cooking surface areas. Metal objects can become hot and cause burns.
- Do not place any object on or near the display area in order to prevent accidental activation of the cooktop controls.
- Cookware handles should be turned inward and not extend over adjacent surface units. To reduce the risk of burns, ignition of flammable materials, and spillage due to unintentional contact with the cookware, the handles of cookware should be positioned so that they are turned inward, and do not extend over adjacent surface units.

- Never leave prepared food on the cooking zones. Boilovers cause smoking and greasy spillovers that may ignite, or a pan that has boiled dry may melt or become damaged.
- Do not use aluminum foil to line any part of the cooktop. Only use aluminum foil as recommended after the cooking process, if used as a cover to be placed over the food. Any other use of aluminum foil may result in the risk of electric shock, fire or short circuit.
- Do not clean or operate a broken cooktop. If the cooktop breaks, cleaning solutions and spillovers may penetrate the broken cooktop and create a risk of electric shock. Contact a qualified technician immediately.
- Never leave surface units unattended at high heat settings. Boilover causes smoking and greasy spillovers that may ignite.
- Always turn off all controls when cooking is completed.
- Keep pets away from the product to avoid risk of fire or burns. Do not allow pets to climb on the product even when it is not in operation.
- Liquids such as water, coffee or tea are able to be overheated beyond the boiling point without appearing to be boiling, due to surface tension of the liquid. Visible bubbling or boiling is not always present when the container is removed from the cooktop. This could result in very hot liquids suddenly boiling over when the container is disturbed or a spoon or other utensil is inserted into the liquid. To reduce the risk of injury to persons:
 - Do not overheat the liquid.
 - Stir the liquid both before and halfway through heating it.
 - Do not use straight-sided containers with narrow necks.
 - After heating, allow the container to stand on the cooktop for a short time before moving the container.
 - Use extreme care when inserting a spoon or other utensil into the container after heating.
- Do not use the cooktop as a work surface or storage space.
- Do not operate the cooking zones with empty pots or pans.
- Do not turn on the cooking zones with no pots or pans on the element.
- The cooking process has to be supervised. A short term cooking process has to be supervised continuously.
- The appliance must not be installed behind a decorative door in order to avoid overheating.

Maintenance

- Do not repair or replace any part of the appliance. All servicing should be done only by a qualified technician to avoid the risk of personal injury and damage to the appliance.
- Take care to avoid steam burns if using a wet sponge or cloth to wipe spills on a hot cooking area.
- Wait for the cooktop to cool before using cooktop cleaners. Some cleaners can produce NOXIOUS FUMES if applied to a hot surface.
- If the supply cord is damaged, it must be replaced by the manufacturer, its service agent or similarly qualified persons in order to avoid a hazard.
- If your appliance malfunctions or fractures, switch off all cooking zones, and contact an LG Customer Information Center for service.
- Always keep the control panel clean and dry. Do not let liquids or grease remain on the cooktop display area. Spilled or burnt-on foods can activate or deactivate the appliance. Clean the display area thoroughly to resume normal operation of the appliance.
- Clean the appliance regularly to keep all parts free of grease that could catch fire. Exhaust fan ventilation hoods and grease filters should be kept clean. Do not allow grease to accumulate on the hood or filters. Greasy deposits in the fan could catch fire. Refer to the hood manufacturer's instructions for cleaning.

6 IMPORTANT SAFETY INSTRUCTIONS

Safety Standard for Button Cell or Coin Batteries

WARNING

- **INGESTION HAZARD:** This product contains a button cell or coin battery.
- **DEATH** or serious injury can occur if ingested.
- A swallowed button cell or coin battery can cause **Internal Chemical Burns** in as little as **2 hours**.
- **KEEP** new and used batteries **OUT OF REACH of CHILDREN**.
- **Seek immediate medical attention** if a battery is suspected to be swallowed or inserted inside any part of the body.



- Remove and immediately recycle or dispose of used batteries according to local regulations and keep away from children.
 - Do NOT dispose of batteries in household trash or incinerate.
- Even used batteries may cause severe injury or death.
- Call a local poison control center for treatment information.
- Non-rechargeable batteries are not to be recharged.
- Do not force discharge, recharge, disassemble, heat above 140 °F (60 °C) or incinerate.
 - Doing so may result in injury due to venting, leakage or explosion resulting in chemical burns.
- Product contains non-replaceable batteries.
- Battery Type : MS621FE
- Nominal Voltage : 3.0 V

CAUTION STATEMENTS

CAUTION

- To reduce the risk of minor or moderate injury to persons, malfunction, or damage to the product or property when using this product, follow basic precautions, including the following:

ENGLISH

Operation

- This appliance may only be used for normal cooking and frying in the home. It is not designed for commercial or industrial purposes.
- Use proper pan sizes. This appliance is equipped with one or more surface units of different sizes.
- Select cookware having flat bottoms large enough to cover the cooking zones. The pan detection sensors will not allow the affected cooking zones to operate without a pan present.
- Only certain types of glass, glass/ceramic, ceramic, earthenware, or other glazed cookware are suitable for rangetop service without breaking due to the sudden change in temperature. Check the manufacturer's recommendations for cooktop use.
- Do not place hot cookware on cold cooktop glass. This could cause the glass to break.
- Do not slide pans across the cooktop surface. They may scratch the cooktop surface.
- Do not let pans boil dry. This may cause permanent damage in the form of breakage, fusion, or marking that can affect the ceramic-glass cooktop. (This type of damage is not covered by your warranty.)
- Cook meat and poultry thoroughly, meat to at least an INTERNAL temperature of 160 °F and poultry to at least an INTERNAL temperature of 180 °F. Cooking to these temperatures usually protects against food-borne illnesses.
- Prior to using the cooktop for the first time, apply the recommended cooktop cleaning cream to the ceramic surface. Buff with a non-abrasive cloth or pad. This will make cleaning easier when the cooktop gets soiled from cooking. The special cooktop cleaning cream leaves a protective finish on the glass to help prevent scratches and abrasions.
- Please be careful of the cooktop edges when moving pots and pans.
- Ceramic glass is very tough, and impervious to sharp temperature changes, but is not unbreakable. It can be damaged if hard or sharp objects fall on it.
- Be very cautious if using pots made of cast iron, or other pots with rough edges or burrs. Moving these can cause scratches on the glass.
- Do not slide metal or glass across the cooktop surface.
- Do not use cookware with any dirt buildup on the bottom.
- Do not use cookware with rough or uneven bottoms. This cookware can mark and scratch the cooktop surface.
- Do not use the glass cooktop surface as a cutting board.
- The appliance is not intended to be operated by means of an external timer or separate remote-control system.

Maintenance

- Always switch off the appliance before cleaning.
- For safety reasons, do not clean the appliance with a steam jet or high-pressure cleaner.
- Clean the cooktop in accordance with the maintenance and cleaning instructions in this manual.
- Do not use harsh abrasive cleaners or rough metal scrapers to clean the cooktop glass since they can scratch the surface, which may result in shattering of the glass.
- Clean the cooktop cautiously. Do not use sponges or cloth to wipe spills on a hot cooking area. Use a proper metal scraper.

8 IMPORTANT SAFETY INSTRUCTIONS

- If sugar or a mixture containing sugar falls onto a hot cooking zone and melts, remove it with a metal scraper immediately, while still hot. If left to cool down, it may damage the surface when removed. Use caution and wear an oven mitt to avoid burns.
- Keep meltable objects or materials away from the ceramic glass surface, for example, plastic utensils, aluminum foil, or cooking wraps. If any materials or foodstuffs melt on the ceramic-glass surface, these should be cleaned up immediately.
- Use oven mitts to avoid burns when using a metal scraper on a hot cooking zone.
- Refer to the Maintenance section for proper cleaning and maintenance of the cooktop.

Disposal of Old Appliances

To protect the environment, it is important that worn-out appliances are disposed of in the correct manner.

- The appliance must not be disposed of with household rubbish.
- You can obtain information about collection dates or public refuse disposal sites from your local government or waste collection service.
- Before disposing of old appliances make them inoperable so they cannot be a source of danger. To do this, have a qualified person disconnect the appliance from the house circuitry.

SAVE THESE INSTRUCTIONS

PRODUCT OVERVIEW

Product Features

- 4 Bolts (2 ea)
- 5 Type A Screws (2 ea)

Parts and Features

Throughout this manual, features and appearance may vary from your model.

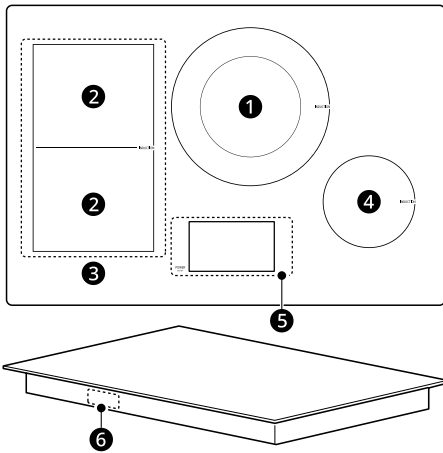

ENGLISH

Parts and Features	
1	Dual Cooking Zone 11 1/8" / 7 1/16" (283 mm / 180 mm)
2	Single Cooking Zone 8 1/2" x 7 1/4" (216.2 mm x 185 mm)
3	Flexible Cooking Zone 8 1/2" x 14 9/16" (216.2 mm x 370 mm)
4	Single Cooking Zone 6 1/2" (165 mm)
5	Control Panel
6	Rating Label Model and Serial Number Plate

Accessories

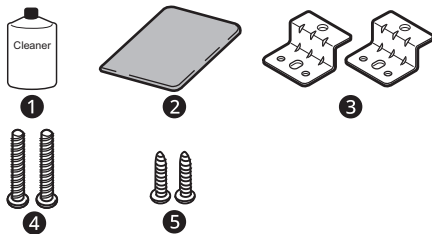

- 1 Cooktop Cleaner (1 ea)
- 2 Non-scratch Scouring Pad (1 ea)
- 3 Retainer Brackets (2 ea)

10 INSTALLATION

INSTALLATION

Before Installing

Before You Begin

Installation and service must be performed by a qualified installer.

Important: Save these instructions for the local electrical inspector's use. Read and save these instructions for future reference.

Read these instructions completely and carefully.

CAUTION

- If storage is located under the cooktop, do not use it to store flammable or heat-sensitive items such as detergents, aerosols, cleaners, water, food, or plastics.

NOTE

Installer:

- Read all installation instructions before installing the cooktop.
- Remove all packing material before connecting the electrical supply to the cooktop.
- Observe all governing codes and ordinances.
- Only certain cooktop models may be installed over certain built-in electric oven models.
- Be sure to leave these instructions with the consumer.

NOTE

Consumer:

- Keep the owner's manual and installation instructions for future reference.

NOTE

- This appliance must be properly grounded.
- Damage caused by failure to follow these instructions is not covered by the cooktop warranty.

Tools Needed

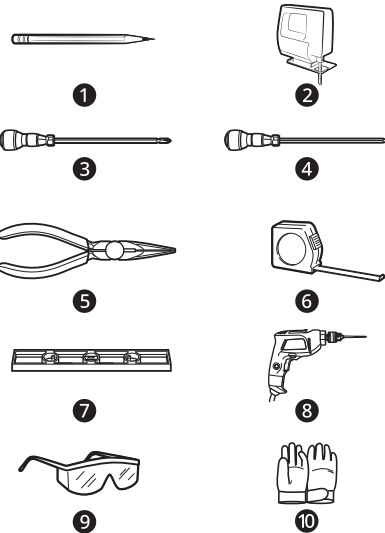

- 1 Pencil
- 2 Saber Saw
- 3 Phillips Screwdriver
- 4 Flat-Blade Screwdriver
- 5 Pliers
- 6 Tape Measure
- 7 Level
- 8 Drill
- 9 Safety Glasses
- 10 Gloves

Parts not Provided

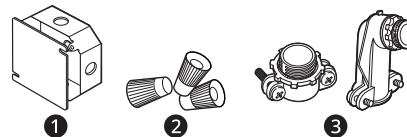

- 1 Junction Box
- 2 Wire Nuts
- 3 Strain Relief (Conduit Connector)

Unpacking the Cooktop

- 1 Unpack and visually inspect the cooktop for any damage or missing components.
- 2 Be sure the bottle of cleaner and conditioner packed in the literature bag is left where the user can find it easily. It is important that the

ceramic-glass cooktop be pretreated before use. See Care and Cleaning.

Model and Serial Number Location

The model and serial numbers are located on a plate on the front side of the cooktop. Please record them in this guide; you will need them for warranty registration.

ENGLISH

Technical Specifications

Models		CBIS3018BE		
Description		Induction Cooktop		
Electrical Specifications	Connection voltage	240/208 VAC 60 Hz., 36.7 A / 34.6 A		
	Maximum connected power load	8800 W / 7179 W		
Cooktop Dimensions		30 11/16" (781 mm) (W) × 4 1/8" (105 mm) (H) × 21 1/16" (534 mm) (D)		
Countertop Cutout Dimensions		Standard Installation 28 1/2" (724 mm) (W) × 5 3/4" (146 mm) (H) × 19 5/8" (498 mm) (D)		
Cooking Zones	Position	Size	Power (Level 9 / Boost)	
	Front Left	8 1/2" x 7 1/4" (216.2 mm x 185 mm)	1513/3026 W (208 V) 1850/3700 W (240 V)	
	Front Right	6 1/2" (165 mm)	1145/1472 W (208 V) 1400/1800 W (240 V)	
	Rear Left	8 1/2" x 7 1/4" (216.2 mm x 185 mm)	1513/3026 W (208 V) 1850/3700 W (240 V)	
	Flex Left	8 1/2" x 14 9/16" (216.2 mm x 370 mm)	2699/3026 W (208 V) 3300/3700 W (240 V)	
	Center	11 1/8" / 7 1/16" (283 mm / 180 mm)	Inner Burner: 1513/3026 W (208 V) 1850/3700 W (240 V) Dual Burner: 3026/4089 W (208 V) 3700/5000 W (240 V)	

NOTE

- The maximum power of each cooking zone depends on the size and material of the cookware used.

12 INSTALLATION

Preparing the Installation Location

Important Installation Information

- All electric cooktops run off a single phase, three-wire or four-wire cable, 240/208 volt, 60 hertz, AC-only electrical supply with ground.
- Minimum distance between cooktop and overhead cabinetry is 30" (762 mm).
- Make sure the cabinets and wall coverings around the cooktop can withstand the temperatures (up to 93 °C [200 °F]) generated by the cooktop.

Dimensions and Clearances

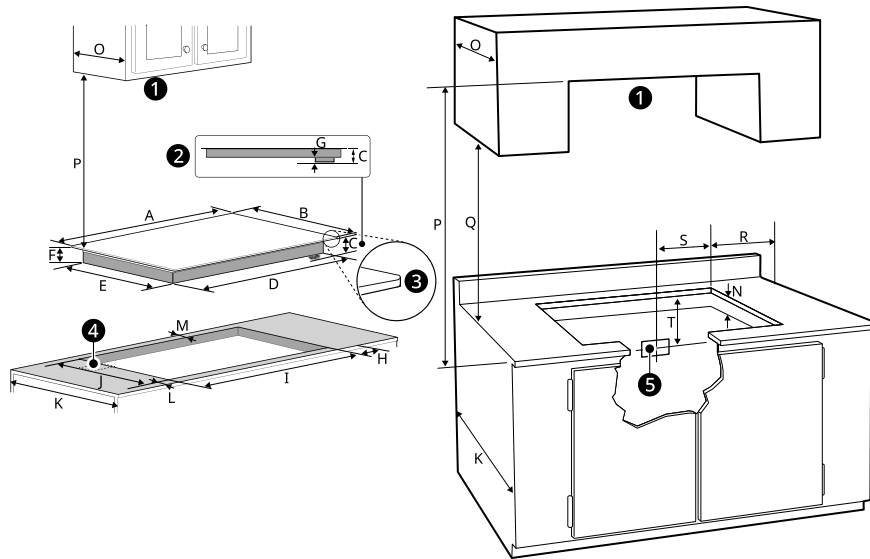

- ❶ Do not obstruct these areas.
- ❷ Right side
- ❸ Radius: 3/8" (10 mm)
- ❹ 4" X 8" (102 mm x 203 mm) opening to route armored cable if panel is present.
- ❺ Approximate location of junction box

-	Dimension/Clearance	30" Cooktop
A	Width of upper plate	30 11/16" (781 mm)
B	Depth of upper plate	21 1/16" (534 mm)
C	Distance from bottom of upper plate to bottom of conduit and terminal block enclosure	3 15/16" (101 mm)
D	Width of cooktop base	27 15/16" (710 mm)
E	Depth of cooktop base	18 13/16" (477 mm)
F	Distance from bottom of upper plate to bottom of cooktop base	2 1/2" (64 mm)

-	Dimension/Clearance	30" Cooktop
G	Height of conduit and terminal block enclosure	1 7/16" (37 mm)
H	Distance from side edge of cutout to side of counter	≥ 1 1/8" (28 mm)
I	Width of cutout	≥ 28 1/2" (724 mm) ≤ 28 5/8" (727 mm)
J	Depth of cutout	≥ 19 5/8" (498 mm) ≤ 19 11/16" (501 mm)
K	Depth of bottom cabinets	23 13/16" (605 mm)
L	Distance from front of counter to front edge of cutout	≥ 2 3/16" (55 mm)
M	Distance from rear edge of cutout to nearest combustible surface	≥ 2 1/16" (52 mm)
N	Height below cutout (Empty space is needed underneath the cooktop for optimum performance.)	≥ 5 3/4" (146 mm)
O	Depth of overhead cabinets	≤ 13" (330 mm)
P	Clearance from top of cooking surface to bottom of overhead cabinets	≥ 30" (762 mm)
Q	Clearance from countertop to bottom of adjacent cabinets	≥ 18" (457 mm)
R	Distance from edge of cooktop to nearest combustible wall (either side of unit)	≥ 2" (50 mm)
S	Junction box (approximate location)	10" (254 mm)
T	Junction box (approximate location)	12" (305 mm)

All dimensions are stated in inches and millimeters (mm).

Allow 2" (50 mm) below the armored cable opening to clear the electric cable and allow space for installation of the junction box on the wall at the back of the cooktop.

Thickness of glass: 3/16" (4 mm)

Throughout this manual, features and appearance may vary from your model.

⚠ CAUTION

- To eliminate the risk of burns or fire by reaching over heated surfaces, cabinet storage space located above the cooktop should be avoided. If cabinet storage is provided, risk can be reduced by installing a range hood that projects horizontally a minimum of 5" (127 mm) beyond the face of the cabinets.
- It is very important to keep 3 5/16" (85 mm) distance between the cooktop and a drawer or oven **1** underneath it.

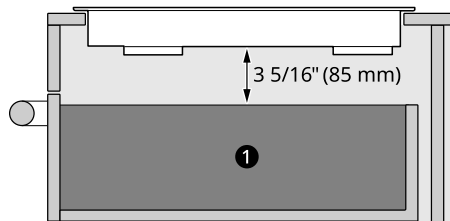

14 INSTALLATION

Installing the Cooktop

Electrical Connections

Important Safety Instructions

- Be sure the cooktop is installed and grounded properly by a qualified installer or service technician.
- This cooktop must be electrically grounded in accordance with local codes or, in their absence, with the National Electrical Code ANSI/NFPA No. 70, latest edition in the United States.

⚠ WARNING

- The electrical power to the cooktop must be shut off while line connections are being made. Failure to do so could result in serious injury or death.

Providing the Electrical Connection

- Install the junction box under the cabinet and run 120/240 or 120/208 Volt, AC wire from the main circuit panel.

NOTE

- DO NOT connect the wire to the circuit panel at this time.

Electrical Requirements

Observe all governing codes and local ordinances

- 1 A 3-wire or 4-wire single-phase 120/240 or 120/208 Volt, 60 Hz AC-only electrical supply is required on a separate circuit fused on both sides of the line (time-delay fuse or circuit breaker is recommended). DO NOT fuse neutral. The fuse size must not exceed the circuit rating of the appliance specified on the nameplate.
- 2 30" induction cooktop can consume up to 8800 W at 240 VAC. A 40 Amp circuit breaker with #8 AWG must be used.

⚠ WARNING

- Do not use an extension cord with this appliance. Doing so may result in a fire, electrical shock, or other personal injury.

NOTE

- Wire sizes and connections must conform to the fuse size and rating of the appliance in accordance with the National Electrical Code ANSI/NFPA No. 70, latest edition, and local codes and ordinances.

- 3 The appliance should be connected to the fused disconnect (or circuit breaker) box through flexible armored or nonmetallic sheathed cable. The flexible armored cable extending from this appliance should be connected directly to the grounded junction box. The junction box should be located as shown in **Dimensions and Clearances** with as much slack as possible remaining in the cable between the box and the appliance, so it can be moved if servicing is ever necessary.

- 4 A suitable strain relief must be provided to attach the flexible armored cable to the junction box.

Electrical Connection

Connect the flexible armored cable that extends from the surface unit to the junction box using a suitable strain relief at the point the armored cable enters the junction box. Then make the electrical connection as follows.

Electrical ground is required on this appliance.

This appliance is manufactured with a supply wire and a frame-connected green or bare copper grounding wire.

NOTE

TO ELECTRICIAN:

- The armored cable leads supplied with the appliance are UL-listed for connection to larger gauge household wiring. The insulation of the leads is rated at temperatures much higher than the temperature rating of household wiring. The current-carrying capacity of the conductor wire is governed by the temperature rating of the insulation around the wire, rather than the wire gauge alone.

⚠ WARNING

- DO NOT ground to a gas supply pipe. DO NOT connect to electrical power supply until appliance is permanently grounded. Connect the ground wire before turning on the power.

- This appliance is equipped with a copper conductor flexible cable. If connection is made to aluminum house wiring, use only special connectors which are approved for joining copper and aluminum wires in accordance with the National Electrical Code and local codes and ordinances. Improper connection of aluminum house wiring to copper leads can result in a short circuit or fire. Follow the connector manufacturer's recommended procedure closely.

Where Local Codes Permit Connecting the Appliance-Grounding Conductor to the Neutral (White) Wire

Observe all governing codes and local ordinances.

- 1 Disconnect the power supply.
- 2 At the circuit breaker box, fuse box or junction box, connect appliance and power supply cable wires as shown.

⚠ WARNING

- You may not ground the cooktop through the neutral (white) wire if cooktop is used in a new branch circuit installation (1996 NEC), mobile home, recreational vehicle, or where local codes do not permit grounding to the neutral (white) wire. When grounding to the neutral (white) wire is prohibited, you must use a 4-wire power supply cable. Failure to heed this warning may result in electrocution or other serious personal injury.

3-Wire Grounded Junction Box

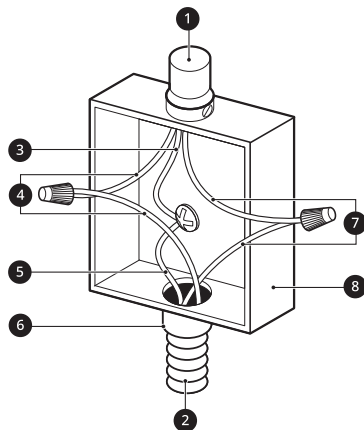

- 1 Cable from Power Supply
- 2 Cable from Cooktop

- 3 White Wire (Neutral)
- 4 Red Wires
- 5 Green Wire (Ground)
- 6 UL-listed Conduit Connector
- 7 Black Wires
- 8 Junction Box

If Cooktop is Used in a New Branch Circuit Installation (1996 NEC), Mobile Home, Recreational Vehicle, or where Local Codes Do Not Permit Grounding to the Neutral (White) Wire

Observe all governing codes and local ordinances.

- 1 Disconnect the power supply.
- 2 At the circuit breaker box, fuse box or junction box, connect appliance and power supply cable wires as shown.

⚠ WARNING

- If connecting to a 4-wire power supply cable electrical system, the appliance frame connected ground wire **MUST NOT** be connected to the neutral wire of the 4-wire electrical system.

4-Wire Grounded Junction Box

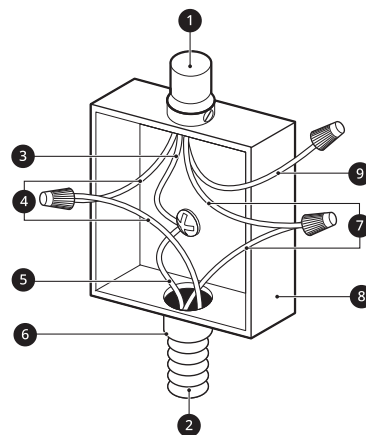

- 1 Cable from Power Supply
- 2 Cable from Cooktop
- 3 Ground Wire
- 4 Red Wires
- 5 Green Wire (Ground)

16 INSTALLATION

- 6 UL-listed Conduit Connector
- 7 Black Wires
- 8 Junction Box
- 9 White Wire (No Connection)

Installing the Cooktop Unit

- 1 Visually inspect the cooktop for damage. Make sure all cooktop screws are tight (see below for locations).

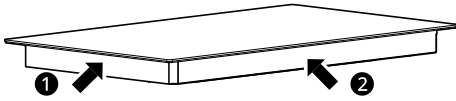

- 1 3 Screws (Same Both Side)
- 2 3 Screws (Same Both Side)

- 2 Check and prepare the installation location.
 - See **Dimensions and Clearances**.

- 3 Carefully lower the cooktop into the countertop cutout, making sure not to trap any wires.

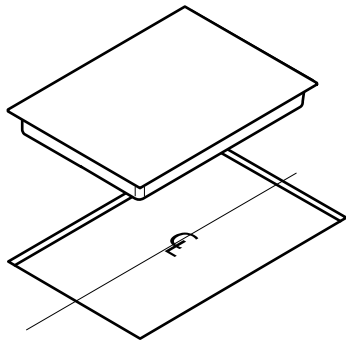

NOTE

- Do not use caulking compound. The cooktop must be removable, should service be required.

- 4 Attach the retainer brackets 1 to the bottom of the cooktop; then snug the bolts against the bottom of the countertop as shown.

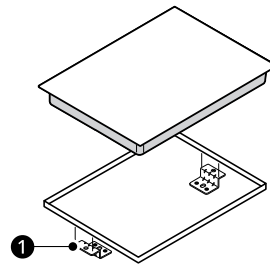

NOTE

- The retainer brackets **MUST** be installed to meet local codes or, in their absence, with the National Electrical Code ANSI/NFPA No. 70, latest edition.
- For flush installation
 - Finish a flush installation by running sealant around the edges of the cooktop.

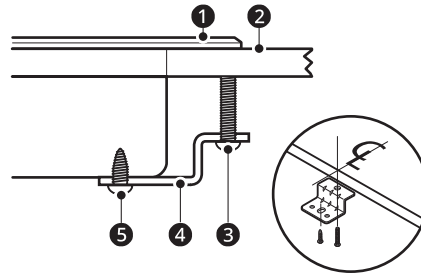

- 1 Cooktop
- 2 Countertop
- 3 Bolt
- 4 Retainer Brackets
- 5 Type A Screw

Final Check

Perform a final operational check of the cooktop, making sure the cooktop powers on properly and that each cooking zone operates correctly. Refer to the Operating Instructions in this guide for details.

OPERATION

Introduction to Induction Cooking

How Induction Cooking Works

An induction coil beneath the ceramic glass cooking surface generates magnetic fields, which act directly on the base of the pots and pans.

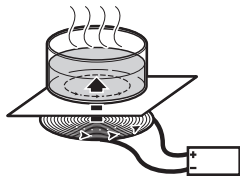

Instead of heating the ceramic glass, this method heats the base of the pan immediately, saving time and energy. Since the heat required for cooking is generated directly in the base of the pan, the cooking zone itself warms up only slightly. The cooktop does not become hot when heat is transferred from the cookware.

IMPORTANT:

- Electromagnetic fields can affect electronic circuits and interfere with portable radios and phones.
- Do not put magnetically active objects (e.g., credit cards, computer diskettes, cassettes) on or near the ceramic glass surface while one or more induction cooking zones are in use.
- Do not put any metal objects (e.g., spoons, pan lids) on the cooking zones as they can become hot when the cooking zones are in use.

Cookware

Induction Cookware

NOTE

- Before using the induction cooking elements, carefully read and follow these cookware recommendations and the instructions in the pan sensing sections.

When purchasing pans for use on the induction cooktop, look for cookware identified by the manufacturer as "induction ready" or "induction capable", or that is marked by the manufacturer as specifically designed for induction cooking.

The base material of the cookware must be magnetic for the cooking elements to activate. Use

a magnet to check if the cookware base material is suitable. If the magnet sticks to the bottom of the cookware, the cookware can be used for induction cooking.

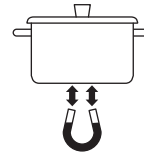

For the best possible surface cooking results, use only high-quality, heavy gauge steel cookware on the induction cooking elements. Follow manufacturer's recommendations when using induction cookware.

Induction Cookware Types

The three most common induction cookware types available are stainless steel, cast iron, and porcelain-enamel-coated metals.

- **Stainless Steel** is generally excellent for induction cooking. It is durable, easy to clean, and resists staining.

NOTE

- Not all stainless steel cookware is magnetic; stainless steel is not always suitable for induction cooking.
- **Cast iron** cooks evenly and is also good for induction cooking. Do not slide cast iron cookware on the cooktop; cast iron cookware with a rough surface will scratch the ceramic cooktop.
- **Porcelain-enamel-coated metals** have variable heating characteristics depending on the quality of the base metal. Make sure the porcelain-enamel coating is smooth to avoid scratching the ceramic cooktop.

Incompatible Cookware

- Aluminum, nickel-silver pots
- Heat-resistant glass pots
- Roasting pans
- Stone pots
- Stainless steel pots (without the IH mark)

18 OPERATION

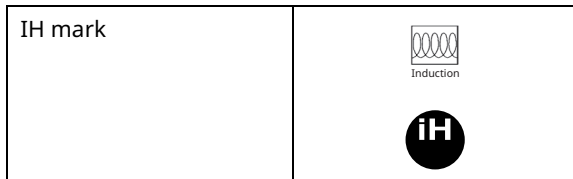

- Without the IH mark, heating may not work well.
- Pots with partially magnetic base
 - Even if there is an IH mark, a container that only has magnetic material on part of the bottom of the container may not be automatically detected or the product may not work properly.

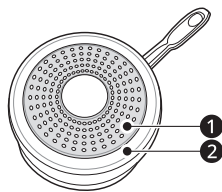

- ① Material that sticks to the magnet
- ② Material that does not stick to magnet
- A pot with legs



- A pot with a round bottom
 - The smaller contact area may give poor results.



- Do not use a container with a flat bottom surface smaller than the burner size.



Pan Preheat Recommendations

Induction cooking may decrease the amount of time required to preheat cookware compared to cooking on a radiant element cooktop or gas surface burner.

Pay close attention to all food items while cooking on the cooktop and until all cooking processes are complete.

⚠ CAUTION

- Remember that induction surface cooking initially heats the cookware **VERY QUICKLY** if the cookware does not contain food.

Noises during Cooktop Operation

The electronic processes involved with induction cooking may create some background noises. You may hear a slight buzzing sound when cooking on the cooktop. These noises are part of the induction cooking process and are considered normal.

Some cookware will buzz, depending on the construction or base material. The buzz may be more noticeable if the contents of the pan are cold. As the pan heats up, the noise will decrease. The noise will also decrease if the power level setting is reduced.

NOTE

- When using the induction cooktop, operational noises are more noticeable while cooking in Boost mode. But very loud noises are not normal when induction cooking.
- The cooktop fan may turn on to reduce the temperature of the product, even when the surface elements are not being used.
- Cookware that is not marked "IH" may make a loud noise.
- Under certain conditions, your cookware may produce a high-pitched whistling noise when two elements are in use at the same time. The power levels at which this occurs may vary depending on the kind of cookware being used. Change the power level to eliminate the noise or reduce its volume.

Use Flat-Bottomed Cookware

Cookware must fully contact the surface of the cooking element. Use flat-bottomed pans sized to fit the cooking element and amount of food being prepared. Check for flatness by rotating a ruler across the bottom of the cookware.

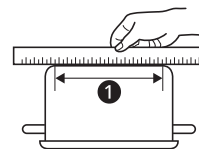

- ① Pan Size

Recommended Cookware Size

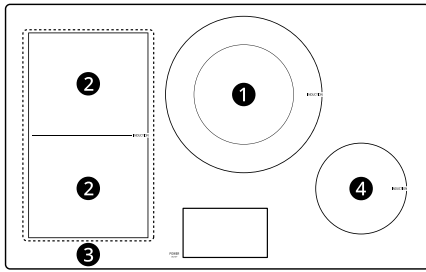

	Pan size
① Dual Cooking Zone	Single: 5 13/16" - 8" (147 mm - 203 mm) Dual: 9" - 11 1/8" (228 mm - 283 mm)
② Single Cooking Zone	5 13/16" - 7 1/4" (147 mm - 185 mm)
③ Flexible Cooking Zone	4 3/4" x 10 5/8" (120 mm x 270 mm)
④ Single Cooking Zone	5 13/16" - 6 1/2" (147 mm - 165 mm)

- The center area is a dual cooking zone which activates single or dual elements depending on pot/pan size. If the cooktop detects cookware that is less than 9" in diameter, only the inner ring (single element) will activate. If it detects cookware larger than 9" in diameter, it will activate both the inner and outer rings (dual element).
- To quickly boil a very large quantity of water, set the center element to Boost, use a pot that is at least 9" in diameter so that the center dual element is activated, and turn off all other elements.

Minimum Cookware Size

- Use cookware with a bottom surface diameter of 5 13/16" (147 mm) or greater.
- For flexible cooking zone, minimum cookware size is 4 3/4" x 10 5/8" (120 mm x 270 mm).

Cookware Placement

Use the proper cookware and place it correctly on the cooktop. One or more of the cooking elements will not heat if any of the incorrect conditions shown is detected by the sensors located below the ceramic cooktop surface. Correct the problem before attempting to use the cooktop.

Correct

- Cookware is centered correctly on surface of cooking element.

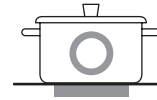

- Pan has flat bottom and straight sides.

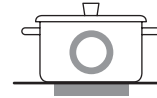

- Pan size meets or exceeds the recommended minimum size for the cooking element.

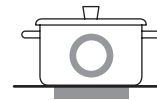

- Pan rests completely on the cooktop surface.

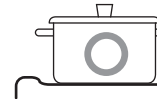

- Pan is properly balanced.



Incorrect

- Cookware is not centered on surface of cooking element.

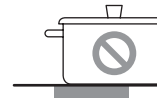

- Pan has curved or warped bottom or sides.

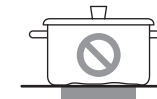

- Pan does not meet the minimum size required for the cooking element used.

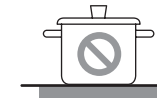

- Pan bottom rests on cooktop trim or does not rest completely on the cooktop surface.

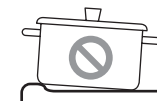

20 OPERATION

- Pan is unbalanced by heavy handle.



Cookware Placement in Flexible Cooking Zones

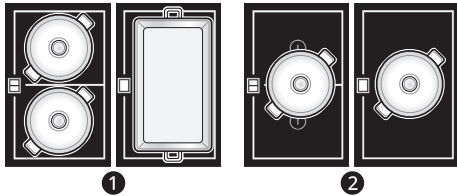

- ❶ Compatible
- ❷ Not compatible

Avoiding Scratches

Use heavier gauge stainless steel cookware on your ceramic cooktop surface. This will help reduce the possibility of developing scratches on the ceramic surface.

Low-quality cookware can scratch the cooktop surface.

Cookware should always be lifted over the ceramic cooktop surface to prevent scratching.

Over time, sliding ANY type of cookware over the ceramic cooktop may alter the overall appearance of the cooktop. Eventually, the buildup of scratches can make cleaning the surface difficult and degrade the overall appearance of the cooktop.

Scratches can also result from grains of sand (from washing vegetables) which are dragged with the pot across the cooking surface.

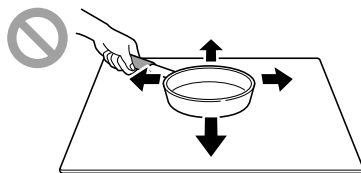

For Best Results

Always follow the recommendations for proper cookware type and size. In addition:

- Do not use dirty pans with grease buildup. Always use pans that are easy to clean after cooking, and make sure that the bottoms of the pans are clean and dry.
- When cooking with large amounts of liquid, use large pots so that nothing can boil over.
- Do not let pans boil dry. This may cause permanent damage in the form of breakage, fusion, or marring that can affect the ceramic

cooktop. (This type of damage is not covered by your warranty.)

- Match the pan size and cooking zone to the amount of food being prepared.

Tips for Saving Energy

- Always position pots and pans before switching on the cooking zone.

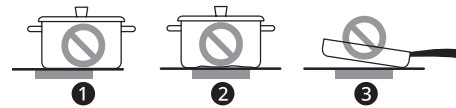

- ❶ not aligned
- ❷ bottom not flat
- ❸ handle too heavy

- Dirty cooking zones and cookware use more electricity.
- Whenever possible, place lids firmly on pots and pans so that they are completely covered.

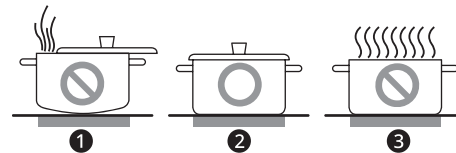

- The base of the pot should be the same size as the cooking zone.

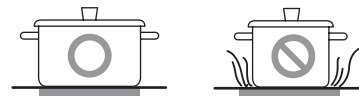

Control Panel

Control Panel Features

Locations of Surface Elements and Controls

The surface burner elements are positioned in the same locations on the cooktop and the control panel for ease of use.

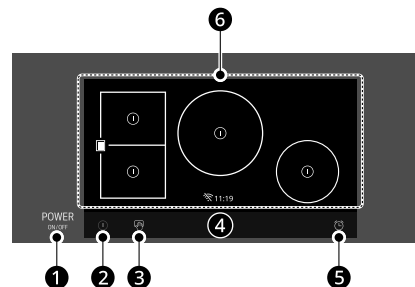

Surface elements and controls	
1	POWER: Press and hold for 1 second to turn the entire cooktop ON. When it is ON, the cooktop is in standby mode until a cooking zone is activated.
2	Pause: Sets the active cooking zone to minimum output. Press to activate or deactivate.
3	Clean Lock: Press to lock the control panel before cleaning it.
4	SETTINGS: Press to adjust settings. For a list of configurable settings, see "Operating Instructions".
5	Kitchen Timer: Press to set a kitchen timer. For details, see "Operating Instructions".
6	Cooktop Control: To check the status of a cooking zone and adjust the cooking zone. For details, see "Operating Instructions".

To operate the control panel, press the button firmly with the flat part of your fingertip.

- 1 After the startup animation, select the desired language and press **NEXT**.
- 2 Set the correct time of day and choose between a 12-hour or 24-hour time format. (The 12-hour format is not available in French.) Then press **NEXT**.
- 3 Read through the application guide in the display and press **DONE**.
- 4 The main screen appears in the display.

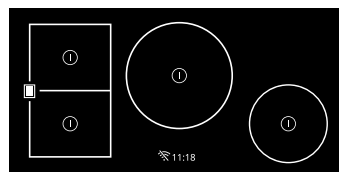

To Set the Element Power Level

Select the number on the element power settings for the active cooking zone to adjust the power level from 1 to 9.

If you've set 17 power levels in the **SETTINGS** menu, press the dots between the numbers to adjust the power level up or down half a step.

Changing Cooktop Settings

Settings

To adjust settings after the initial setup, press the display to open the main screen. Press **SETTINGS** at the bottom center of the main screen. Swipe the screen or press the "<, >" arrow keys to navigate through the settings screens.

Hot Surface Indicator

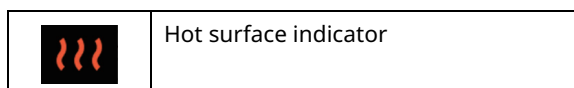

- If this icon is displayed on the screen, be careful because the ceramic glass surface is hot.
 - Failure to do so may result in burns or injuries.
- After turning off the burner, the icon is displayed continuously until the ceramic glass surface cools down.
 - If the temperature near the product is high, it may take longer for the ceramic glass surface to cool down.
- Even after the indicator light has turned off, be careful since the surface may still be hot.

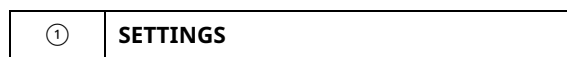
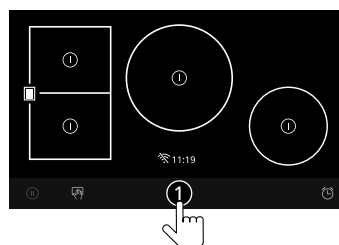

Getting Started

The first time that power is supplied to the cooktop, the **LG Studio** and **LG ThinQ** Application logos are displayed for 1 second each in order. After turning on the cooktop for the first time, adjust the settings to suit your preferences.

Location of Settings

- Page 1: **Lockout, Clock, Wi-Fi, Brightness, Power Levels, Language Selection**
- Page 2: **Volume, Factory Reset, Open Source License**

22 OPERATION

Lockout

The **Lockout** feature automatically prevents most cooktop controls from being turned on. It does not disable the clock or timer.

- If **Lockout** is turned on, all cooktop functions are disabled except the **POWER** button.

Lock

- 1 Press **SETTINGS** at the center bottom of the main screen.
- 2 Press **Lockout** on the first Settings screen.
- 3 Press **LOCK** on the screen.
- 4 When **Lockout** is turned on, the lock icon  appears at the center bottom of the display.

Unlock

- 1 Press any part of the screen while **Lockout** is on.
- 2 A popup screen appears. Press **UNLOCK** for 3 seconds.
- 3 The lock icon disappears from the bottom of the display.

Clock

The clock is displayed on the LCD display when the cooktop is turned on.

Setting Time of Day

- 1 Press **SETTINGS** at the center bottom of the main screen.
- 2 Press **Clock**, then set the correct hour and minutes by scrolling. You can also press the number pad icon  and enter the desired numbers.
- 3 Select either a 12-hour or 24-hour clock mode (12H/24H). The 12-hour mode is not available in French.

- 4 Press **OK**.

Wi-Fi

Connect the appliance to a home **Wi-Fi** network.

Setting Up Wi-Fi

- 1 Press **SETTINGS** at the center bottom of the main screen, and then press **Wi-Fi** in the first settings screen.
- 2 Follow the instructions in the **Wi-Fi** Guide in the display.
- 3 Select **ON**, **OFF**, or **RESET** and press **OK**.
- 4 If **ON** is selected, the **Wi-Fi** icon  appears at the bottom of the display.
- 5 If you select **RESET**, you will have to re-enter the **Wi-Fi** password.

Brightness

Adjust the brightness of the LCD display from 20 % to 100 % in increments of 20 %.

Setting Display Brightness

- 1 Press **SETTINGS** at the center bottom of the main screen, and press **Brightness**.
- 2 Adjust the display brightness by pressing and dragging the dot across the bar, by tapping anywhere on the bar, or by pressing + or -.
- 3 Press **OK**.

Power Levels

- 1 Press **SETTINGS** at the center bottom of the main screen, and press **Power Levels**.
- 2 Choose between 17 levels and 9 levels. (The output of each maximum level is the same.)

- 3 Press **OK**.

Language Selection

Set the display language to English, Spanish, or French.

Selecting a Language

- 1 Press **SETTINGS** at the center bottom of the main screen, and press **Language Selection**.
- 2 Select the desired language.
- 3 Press **OK**.

Volume

Adjust the volume of the cooktop controls.

Setting the Volume

- 1 Press **SETTINGS** at the center bottom of the main screen, swipe to the second settings screen, and press **Volume**.
- 2 Select **MUTE**, **LOW**, or **HIGH**.
- 3 Press **OK**.

Factory Reset

This function returns all settings to the factory defaults.

- 1 Press **SETTINGS** at the center bottom of the main screen, swipe to the second settings screen, and press **Factory Reset**.
- 2 If you want to reset data to the factory defaults, press **RESET** and then **OK**.

NOTE

- All stored data will be deleted.

Open Source License

This screen contains open source software licensing information.

- 1 Press **SETTINGS** at the center bottom of the main screen and swipe to the second settings screen.

- 2 Press **Open Source License**.

Before Using the Cooktop

Before using the cooktop for the first time, clean it thoroughly with the included cleaner or ceramic cooktop cleaner according to the Care and Cleaning instructions in this guide. This will help protect the ceramic surface and make future cleanup easier.

CAUTION

- Never use abrasive scrubbing pads or cleaners. They can cause permanent damage to the cooktop surface.

Activating the Cooktop

To turn on the cooktop, press the **POWER** key for approximately 1 second. The LCD panel will turn on. To turn off the cooktop, press the **POWER** key.

NOTE

- After turning on the cooktop with the **POWER** key, you must select one of the cooking zones within 60 seconds. If no selection is made, the cooktop will turn off for safety.

Automatic Detection

- The automatic detection function checks whether or not a container is placed on top of the burner.
- When a container is placed on the burner, the words "**Auto Detected**" will be displayed. (The words "**Auto Detected**" will disappear after 30 seconds or when the burner is running.)
- The words "**Auto Detected**" will not be displayed if a container is not placed on the burner, and this function is activated initially only once after the power is turned on.
- Depending on the conditions of use (whether the burner is being used, the container material, status of the container base, etc.), the automatic detection time may differ or the cookware may not be detected automatically.

24 OPERATION

NOTE

- If the cookware is too small, the words "**Auto Detected**" may not be displayed.
- Minimum cookware size
 - Use cookware with a bottom surface diameter of 5 13/16" (147 mm) or greater.
 - For flexible cooking zone, minimum cookware size is 4 3/4" x 10 5/8" (120 mm x 270mm).

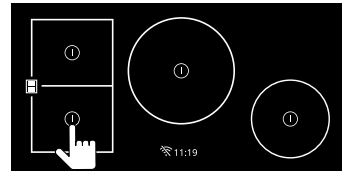

Selecting the Cooking Zone

Place an induction-compatible pan on top of the desired cooking zone.

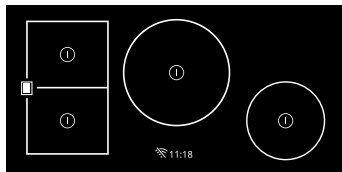

Press the icon ① in the desired cooking zone on the display to set the power level.

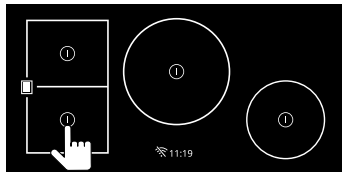

- 2 Selecting a power level turns on the cooking zone. The cooking zone indicator remains lit and the power level is stored.

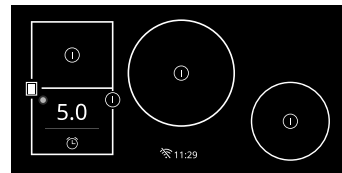

①

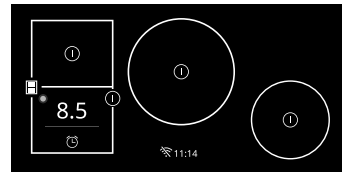

②

① Figure A ② Figure B

NOTE

- Once the cooking zone has been selected the power level must be selected within 3 seconds with the element power settings. Otherwise, the power settings will turn off for safety.

NOTE

- If a power level is not selected, the power settings will turn off after 3 seconds.

Setting the Power Level

The power level for the selected cooking zone can be set from 1 to 9.

Selecting the Power Level

- 1 Press a number in the **Power Levels** popup to set the power level from 1 to 9. If you've set 17 power levels in the settings menu, press the dots between the numbers to adjust the power level up or down half a step.

Readjusting the Power Level

- 1 Press the desired cooking zone in the display to bring up the **Power Levels** popup.

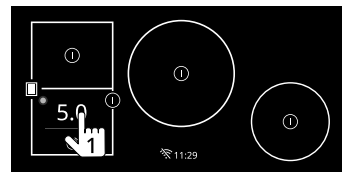

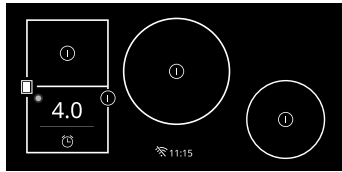

- Press the desired level in the **Power Levels** popup. If no selection is made, the Power Levels popup disappears after 3 seconds and the power level remains the same.

NOTE

- Once the power level is changed, the burner operation is temporarily stopped and then restarted at the changed power level.

Power Level Indicator

- Cooking element LED bar
 - The range provides an LED bar for each cooking element on the cooktop. Check the display and use the LEDs to monitor the power levels of the elements.

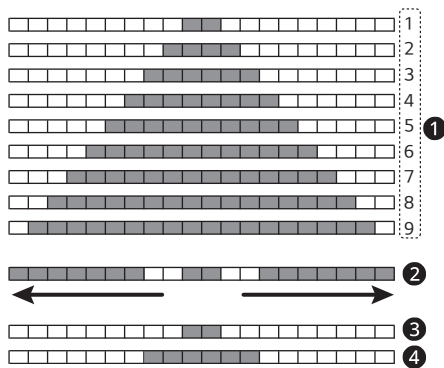

- 9 Step
- Boost
- Melt
- Simmer

- Available power level settings
 - The cooktop control's LED bar displays the element's power level settings, ranging from Level 1 to Level 9 to Boost.

Turning Off the Cooking Zone

- After cooking is complete, press the x icon on the display to turn off the cooking zone.



- The cooking zone corresponding to the display will turn off.

- To turn off all cooking zones, press the **POWER** key.

WARNING

- Your cooktop has a residual heat indicator for each cooking zone. This indicator will warn that this area has been used and is still giving off enough heat to cause burns. Avoid touching the cooking zone when this indicator is shown. Although the cooktop is off, the popup message will stay lit until the cooktop has cooled down.
- Popup message: **Surface is hot. Do not place hot cookware on the display. The display could be damaged.**

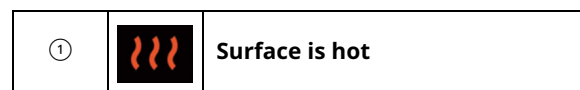
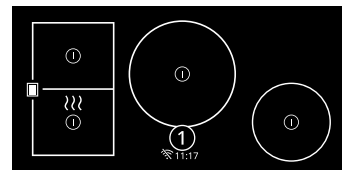

NOTE

- If the following pop-up screen appears during operation, check for the following issues.
 - The cookware is not centered within the cooking zone.
 - The cookware is not compatible with induction cooking.

26 OPERATION

NOTE

- There is no cookware on the cooking zone.

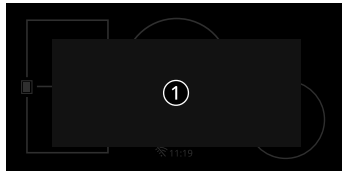

①	Please confirm whether an appropriate container is placed on the cooktop.
---	--

Tips for Induction Cooking

Getting the results you want when cooking can take a bit of time and effort. If you are not familiar with induction cooking, it may take a bit of practice or adjusting of your usual methods to achieve the expected results. Using the cooking chart and these cooking tips as a guide, you will soon be enjoying the benefits of induction cooking.

- The quantity or quality of some foods can affect their cooking times.
- When safe, allow food to come to room temperature before cooking to take advantage of induction's ability to heat food quickly.
- Cookware heats up very quickly when induction cooking. Check food or liquids occasionally and stir or reduce heat to avoid scorching, overcooking, splattering, or boilovers.
- Sauces, soups, and stews may heat up more quickly than you are used to and boil over if not watched. For best results, stir frequently.
- Overcooked food loses moisture and tastes dry, while undercooked food can cause illness. For

best results, use a thermometer to ensure that food is heated to a safe internal temperature.

- Use nonstick or seasoned pans when cooking to reduce the amount of additional fat added to a recipe.
- Don't overcrowd cookware. To avoid slow cooking times and poor results, use cookware that is appropriately sized for the amount of food you are cooking.
- When boiling water on the center element, an 11" diameter pot gives the best performance and saves the most time.
- Use the Boost setting to quickly boil water, or whenever you need extra heating power in one element.
- To quickly boil a very large quantity of water, set the center element to Boost, use a pot that is at least 9" in diameter so that the center dual element is activated, and turn off all other elements.
- To prevent damage to the product, the cooking zones are separated into two groups, and you can only use the Boost function on one cooking zone in each group at once. As shown, you can use Boost on a cooking zone in group ① and a cooking zone in group ② at the same time. If the power range is exceeded by selecting the Boost function, a power management function automatically reduces the heat setting of the cooking zone. If you try to use Boost on two cooking zones in the same group, the power level is automatically set to 9 rather than Boost.

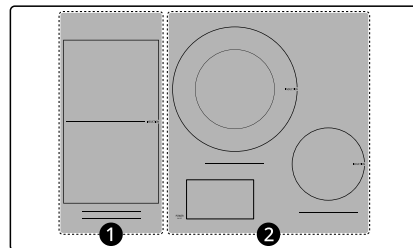

Cooking Function	Example Food Item	Power Level	Notes/Comments
Melting	• Chocolate Over Direct Heat	1 or Melt	Stir continuously to prevent scorching. If using a double boiler to melt chocolate, use power level 2.
	• Butter	2	Monitor carefully to prevent poor results.
Reheating	• Soups & Stews	3-4	Monitor carefully and stir frequently to achieve desired results.

Cooking Function	Example Food Item	Power Level	Notes/Comments
Sweating Vegetables	<ul style="list-style-type: none"> Onions Carrots Celery Peppers 	5-6	To sweat vegetables, cook them until they release moisture, without browning.
Simmering	<ul style="list-style-type: none"> Tomato Sauce Cheese Sauce 	Simmer	Monitor carefully to prevent spillovers. To steam vegetables or grains, bring cooking liquid to a simmer, cover the pot, and reduce heat to power level 2.
	<ul style="list-style-type: none"> Potatoes Grains Stocks/Broths or Stews 	4-5-6	
Sautéing or Other	<ul style="list-style-type: none"> Steaks/Chops Eggs Breakfast Meats Frozen Vegetables Stir Frying 	5-6-7	Monitor carefully and stir frequently to achieve desired results.
Searing/Browning	<ul style="list-style-type: none"> Browning Beef For Chili or Stews Steaks or Chops 	8-9	Room temperature meats will sear and brown more effectively. Fat may splatter if power level is too high.
Frying/Deep Frying	<ul style="list-style-type: none"> Fried Chicken French Fries Battered Fish/Shellfish 	7-8	Fat may splatter if power level is too high.
Blanching Vegetables	<ul style="list-style-type: none"> Broccoli Cauliflower Green Beans 	8-9	Monitor carefully to prevent spillovers.
Boiling	<ul style="list-style-type: none"> Pasta Water Shellfish 	8-9-Boost	Do not fill pot to rim. Water can boil over if the power level is too high.

NOTE

- These settings are recommended guidelines for cooking. You may need to adjust the power level for the type of food and pan. Cooking times for some foods will vary depending on quantity or quality.

Turning Simmer On

Place the cookware on any cooking zone except for the front right cooking zone. Activate the **Power Levels** popup and press the **SIMMER** key.

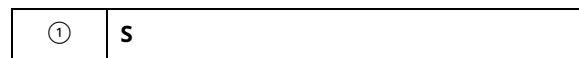
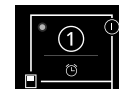

Using the Cook Modes

SIMMER

Use **SIMMER** to simmer sauces or stews.

NOTE

- The Simmer function is not available when using the flex mode in the Flexible Cooking Zone.

28 OPERATION

MELT

Use **MELT** to melt items such as chocolate or butter without scorching.

Turning Melt On

Place the cookware on the front right cooking zone. Activate the **Power Levels** popup and press the **MELT** key.

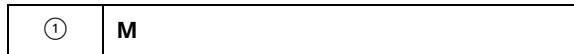
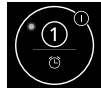

BOOST

Use the Boost function to boil water or heat up large quantities of food quickly.

To prevent damage to the product, the cooking zones are separated into two groups, and you can only use the Boost function on one cooking zone in each group at once. As shown, you can use Boost on a cooking zone in group ① and a cooking zone in group ② at the same time. If the power range is exceeded by selecting the Boost function, a power management function automatically reduces the heat setting of the cooking zone. If you try to use Boost on two cooking zones in the same group, the power level is automatically set to **9** rather than Boost.

For safety, after 6 minutes the Boost setting will automatically revert to either power level **9** or the previously set power level.

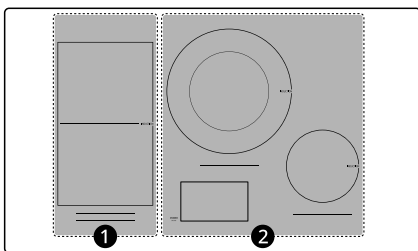

Turning Boost On

Place the cookware on a cooking zone. Activate the **Power Levels** popup and press the **BOOST** key.

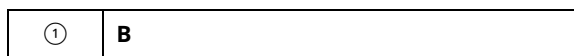

WARNING

- Never use the Boost mode to preheat empty cookware or to heat oil, butter or lard. The cookware may be damaged and the fat or grease may catch fire if overheated.

NOTE

- Under certain conditions, the Boost function will turn off automatically to protect electronic elements inside the cooktop.
- This can occur if the product is used for long periods, when frying, or if cookware is lifted or moved in the Boost mode.

Using the Flexible Cooking Zone

Adjoining cooking zones can be combined to create one large cooking zone with the Flex function. This is especially convenient when cooking in Dutch ovens or other large oblong pans.

Activating the Flexible Cooking Zone

- 1 Place the cookware over the 2 side cooking zones and make sure both cooking zones are activated. The Flex icon will show 2 divided zones.

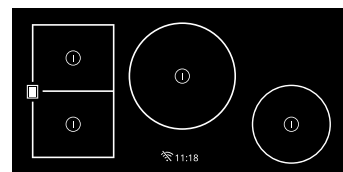

NOTE

- If one of the two burners in the Flex Cooking Zone is functioning, cancel the burner to use the Flex feature.

- 2 To merge the 2 cooking zones, press the Flex icon. The icon will change to show one combined zone.

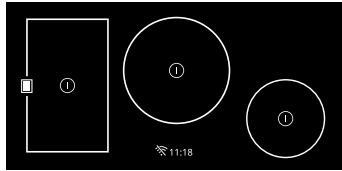
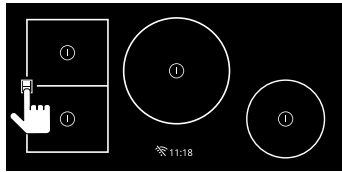

- 3 Select the desired power level.
- 4 To turn off Flex mode, press the Flex icon again.

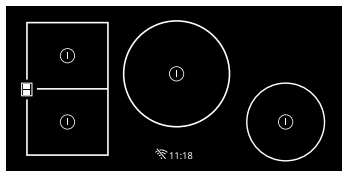
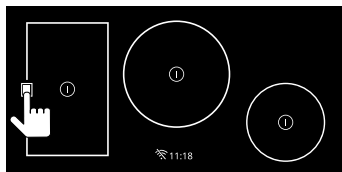

Using the Dual Cooking Zone

The dual element, located in the center position, offers two differently sized elements to accommodate different pan sizes. The cooking zone automatically activates the single or double cooking zone, supplying the proper power to optimize cooking results. The effectiveness of the pan sensing depends on the material and properties of the cookware being used.

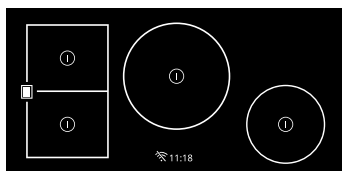

Activating the Dual Cooking Zone

- 1 To activate the larger cooking zone, place a pan that is at least 9" (23 cm) in diameter on the cooking zone.
- 2 Select the desired power level.

Other Functions

Pause

The pause function reduces the power level of a cooking zone to level 1 and maintains it at that level until deactivated. To use the pause function, press the Pause icon. To turn off the pause function, press Pause again to return the cooking zone to the previous power level.



Clean Lock

Use this function when cleaning the screen area of the cooktop. Press the Clean Lock icon to lock the controls for 30 seconds. To unlock the controls, wait 30 seconds or press the Clean Lock icon for 1 second.

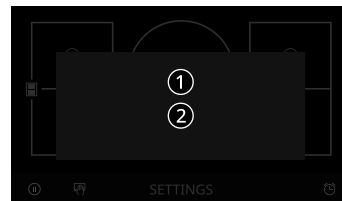

①	Clean Lock ON
②	To cancel the Clean Lock function, press Clean Lock for 1 second.

Timer

Kitchen Timer

The Kitchen Timer acts as a simple timer and does not turn off the cooking zone. It is not tied to any specific cooking zone. When the set time has passed, it sounds an alarm.

30 OPERATION

- Press the Kitchen Timer icon. Scroll (or use the keypad icon) to set the desired hours, minutes, and seconds, then press **OK**.

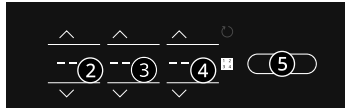
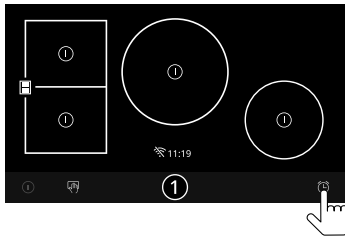

①	SETTINGS
②	hr
③	min
④	sec
⑤	OK

- When the set time has passed, a popup screen with "**Timer finished**" appears with the alarm sound.

Cooking Timer

The Cooking Timer also acts as a simple timer. This timer can be set for each cooking zone, and sounds an alarm when the set time has passed.

- If the cooking zone is in use, press the Cooking Timer icon on the active cooking zone. Scroll (or use the keypad icon) to set the desired hours and minutes, then press **OK**.

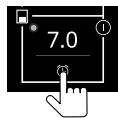

①	hr
②	min
③	OK

- When the set time has passed, a popup screen appears with the alarm sound.
- Press **YES** to turn off the cooking zone.

WARNING

- The Timer function does not automatically turn off the cooktop or cooking zones. Be sure to press the **POWER** key to turn the cooktop off after cooking.

Automatic Power Level Control

The power level displayed may be different from the actual power level at the high end of the temperature range. To prevent the cooktop from overheating, the power level is controlled automatically.

NOTE

- Power Cycling
 - It is normal for heating elements to cycle On/Off during use to control output power.

Cookware Compatibility Indicator

The cookware compatibility indicator can be used to determine if a container will heat well on an induction burner.

- The compatibility indicator may vary due to conditions such as voltage, cookware size, or cookware temperature. Use cookware with a bottom diameter that is suitable for the size of the cooking zone.
- The compatibility indicator may vary depending on the cooking zone.
- The cookware compatibility indicator displayed on this product is based on internal manufacturer standards. Environmental conditions may cause inaccurate or variable results. Use the results only as a reference point.

Using the Compatibility Indicator

- Turn off all cooking zones.
 - If more than one burner is running, this function will not work.
- Place one piece of cookware on the cooktop you want to use.
 - Place cookware in the center of the cooking zone.

3 Set the output level to **9**.

4 Long press (more than 3 seconds) on the power level area to display the cookware compatibility indicator.

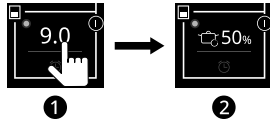

- ① Long press (more than 3 seconds) on level **9**.
- ② The cookware compatibility indicator is displayed.

Indicator	Compatibility
0 - 30	Low
40 - 80	Medium
90 - 100	High

- The higher the indicator, the better the cookware heats up (in the range of 0 to 100%, in 10% increments).
- If the indicator is low, check the material, size and shape of the cookware base.
 - Even if the cookware has an IH mark, if the indicator is low the cookware may not heat properly on this appliance.
 - If the cookware size does not properly match the element size, the indicator may be low. Try again with a different size element.

32 SMART FUNCTIONS

SMART FUNCTIONS

LG ThinQ Application

This feature is only available on models with Wi-Fi.

The LG ThinQ application allows you to communicate with the appliance using a smartphone.

LG ThinQ Application Features

- **Monitoring**
 - This function helps you check the current status, remaining time and cook settings in one place.
- **Product Notifications**
 - Turn on the Push Alerts to receive appliance status notifications. The notifications are triggered even if the LG ThinQ application is not open.
- **Interworking Function**
 - The LG ThinQ application automatically turns on/off the vent fan when paired with the cooktop. Both products must be connected to the LG ThinQ application and have an interworking function.
- **Firmware Update**
 - Keep the appliance updated.

NOTE

- If you change your wireless router, Internet service provider, or password, delete the connected appliance from the LG ThinQ application and connect it again.
- To disconnect the appliance from the Wi-Fi network, delete the cooktop from the list of connected products in the LG ThinQ application.
- The appliance is not intended to be operated by means of remote control system.
- This information is current at the time of publication. The application is subject to change for product improvement purposes without notice to users.

Installing LG ThinQ Application and Connecting an LG Appliance

Models with QR Code

Scan the QR code attached to the product using the camera or a QR code reader application on your smartphone.

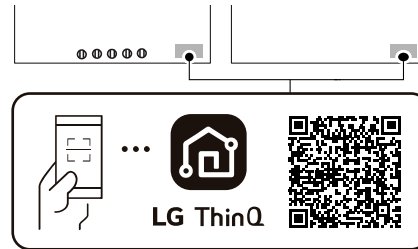

Models without QR Code

- 1 Search for and install the LG ThinQ application from the Google Play Store or Apple App Store on a smartphone.
- 2 Run the LG ThinQ application and sign in with your existing account or create an LG account to sign in.
- 3 Touch the add (~) button on the LG ThinQ application to connect your LG appliance. Follow the instructions in the application to complete the process.

NOTE

- To verify the Wi-Fi connection, check that the Wi-Fi icon on the control panel is lit.
- The appliance supports 2.4 GHz Wi-Fi networks only. To check your network frequency, contact your Internet service provider or refer to your wireless router manual.
- LG ThinQ is not responsible for any network connection problems or any faults, malfunctions, or errors caused by network connection.
- The surrounding wireless environment can make the wireless network service run slowly.
- If the distance between the appliance and the wireless router is too far, the signal becomes weak. It may take a long time to connect or fail to install the application.

- If the appliance is having trouble connecting to the Wi-Fi network, it may be too far from the router. Purchase a Wi-Fi repeater (range extender) to improve the Wi-Fi signal strength.
- The network connection may not work properly depending on the Internet service provider.
- The Wi-Fi may not connect or the connection may be interrupted because of the home network environment.
- If the appliance cannot be connected due to problems with the wireless signal transmission, unplug the appliance and wait about a minute before trying again.
- If the firewall on your wireless router is enabled, disable the firewall or add an exception to it.
- The wireless network name (SSID) should be a combination of English letters and numbers. (Do not use special characters.)
- Smartphone user interface (UI) may vary depending on the mobile operating system (OS) and the manufacturer.
- If the security protocol of the router is set to **WEP**, network setup may fail. Change the security protocol (**WPA2** is recommended), and connect the product again.

LG UP Feature (USA Only)

Experience new features by updating the product through the LG ThinQ application.

If an updatable feature is available, an update notification appears on the product's LCD screen when the power key is pressed to turn off the product.

If the product is not connected to the LG ThinQ application, a product connection notification appears.

- 1 Update notifications are sent to your smartphone when updatable features are available.
- 2 Press the update notification on your smartphone to enter the LG Update Center in the LG ThinQ application.
- 3 In the LG Update Center, select a new function and press the Update button.
 - Do not unplug the product during the update, as doing so may interrupt the update process.

- 4 After the update is complete, check the guide in the LG ThinQ app for detailed feature settings.

NOTE

- This feature is only available on some models.
- After the update is complete, the actual product features may differ from those described in the owner's manual.

RF Module Specifications

Type	Frequency Range	Output Power (Max)
Wi-Fi	2412 MHz - 2462 MHz	< 30 dBm
Bluetooth	2402 MHz - 2480 MHz	

FCC Statement

This equipment has been tested and found to comply with the limits for a Class B digital device, pursuant to part 15 of the FCC Rules for transmitter module and part 18 of the FCC Rules for this equipment. These limits are designed to provide reasonable protection against harmful interference in a residential installation. This equipment generates, uses and can radiate radio frequency energy and, if not installed and used in accordance with the instructions, may cause harmful interference to radio communications. However, there is no guarantee that interference will not occur in a particular installation. If this equipment does cause harmful interference to radio or television reception, which can be determined by turning the equipment off and on, the user is encouraged to try to correct the interference by one or more of the following measures:

- Reorient or relocate the receiving antenna.
- Increase the separation between the equipment and the receiver.
- Connect the equipment into an outlet on a circuit different from that to which the receiver is connected.
- Consult the dealer or an experienced radio/TV technician for help.

This device (transmitter module contained in this product) complies with part 15 of the FCC Rules. Operation is subject to the following two conditions:

34 SMART FUNCTIONS

(1) This device may not cause harmful interference and

(2) This device must accept any interference received, including interference that may cause undesired operation.

Any changes or modifications in construction of this device which are not expressly approved by the party responsible for compliance could void the user's authority to operate the equipment.

FCC RF Radiation Exposure Statement

This equipment complies with FCC radiation exposure limits set forth for an uncontrolled environment. This transmitter must not be co-located or operating in conjunction with any other antenna or transmitter.

This equipment should be installed and operated with a minimum distance of 20 cm (7.8 inches) between the antenna and your body. Users must follow the specific operating instructions for satisfying RF exposure compliance.

Industry Canada Statement

This device contains licence-exempt transmitter(s)/ receiver(s) that comply with Innovation, Science and Economic Development Canada's licence-exempt RSS(s). Operation is subject to the following two conditions:

- (1) This device may not cause interference.
- (2) This device must accept any interference, including interference that may cause undesired operation of the device.

IC Radiation Exposure Statement

This equipment complies with IC radiation exposure limits set forth for an uncontrolled environment.

This equipment should be installed and operated with a minimum distance of 20 cm (7.8 inches) between the antenna and your body.

NOTE

- THE MANUFACTURER IS NOT RESPONSIBLE FOR ANY RADIO OR TV INTERFERENCE CAUSED BY UNAUTHORIZED MODIFICATIONS TO THIS EQUIPMENT. SUCH MODIFICATIONS COULD VOID THE USER'S AUTHORITY TO OPERATE THE EQUIPMENT.
-

Open Source Software Notice Information

To obtain the source code that is contained in this product, under GPL, LGPL, MPL, and other open source licenses that have the obligation to disclose source code, and to access all referred license terms, copyright notices and other relevant documents, please visit <https://opensource.lge.com>.

LG Electronics will also provide open source code to you on CD-ROM for a charge covering the cost of performing such distribution (such as the cost of media, shipping, and handling) upon email request to opensource@lge.com.

This offer is valid to anyone in receipt of this information for a period of three years after our last shipment of this product.

MAINTENANCE

Care and Cleaning

Make sure that the electrical power is off and all surfaces are cool before cleaning any part of the cooktop.

Cleaning the Cooktop

Normal Daily Use Cleaning

CAUTION

- If any sugar or food containing sugar spills, or plastic or foil melts on the cooktop, remove the material **IMMEDIATELY** with a metal razor scraper while the cooking surface is still hot to avoid the risk of damage to the glass-ceramic surface. When used correctly, the scraper will not damage the cooktop surface. For your safety, please use an oven mitt or pot holder while scraping the hot cooking surface.
- If water or food containing water spills, remove the spill **IMMEDIATELY** with a dry paper towel.
- Do not use scrub pads or abrasive cleaning pads. They may damage your cooktop surface.
- For your safety, wear an oven mitt or pot holder while cleaning the hot cooking surface.

Use ceramic cooktop cleaner on the glass cooktop. Other creams may not be as effective or may scratch, damage or stain the cooktop surface.

To maintain and protect the surface of the glass cooktop, follow these steps:

- 1** Before using the cooktop for the first time, clean it with a ceramic cooktop cleaner. This helps protect the top and makes cleanup easier.
- 2** Use ceramic cooktop cleaner regularly to help keep the cooktop looking new. Always allow the cooktop to cool before using ceramic cooktop cleaner.
- 3** Shake the cleaning cream well. Apply a few drops of cleaner directly to the cooktop.
- 4** Use a paper towel to clean the entire cooktop surface.

- 5** Rinse with clear water and use a dry cloth or paper towel to remove all cleaning residue.

NOTE

- Any damage or failure of the product resulting from the items below may not be covered under the **LIMITED WARRANTY**.
 - Sugary spillovers (such as preserves, ketchup, tomato sauce, jellies, fudge, candy, syrups, or chocolate) or melted plastics can cause pitting on the surface of your cooktop.
 - If food or water containing calcium (such as baking powder, wine, milk, spinach, or broccoli) is spilled on the cooktop, it can permanently stain or discolor the surface.

Burned-On Residue

- 1** While the cooktop is still warm, remove any burnt on deposits or spilled food from the glass-ceramic cooking surface with a suitable metal razor scraper. To prevent burns, wear an oven mitt or pot holder while using the metal scraper.

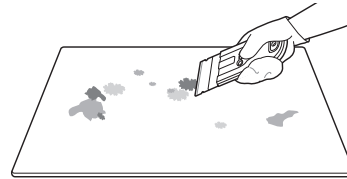

NOTE

- Do not use a dull or nicked blade.
- Hold the scraper at approximately a 30° angle to the cooktop.
- The razor scraper will not damage the markings on the cooking surface.

- 2** When the cooking surface has completely cooled, apply a few fingertip-sized dabs of a glass-ceramic cooktop cleaner in each burner area. Work the cleaning cream over the cooktop surface with a damp paper towel. Leave the cleaner on for 10 minutes before rinsing it off.

36 MAINTENANCE

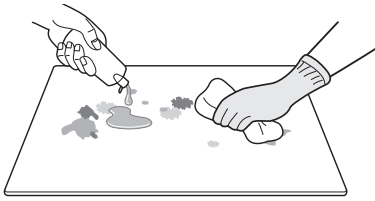

- 3** Rinse with clean water and wipe the cooktop surface with a clean, dry cloth.

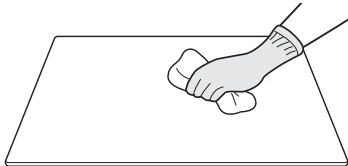

Maintaining the Cooktop

⚠ CAUTION

- Do not use chlorine bleach, ammonia, or other cleaners not specifically recommended for use on glass-ceramic cooktops.
- Let your glass-ceramic cooking surface cool off before cleaning.

	Wipe off with a damp towel and mild detergent	Use a metal scraper	Apply cooktop cleaning cream. Rub with a towel.	Rinse with a damp towel, then wipe dry.
Regular (Recommended after each use)				
Occasional (Recommended every week)				
Thorough (Recommended for tough stains or burnt-on food)				

NOTE

- For additional product information, visit our website at www.lg.com

- Do not use cookware if there is foreign matter on the cooktop surface. Always clean the cooktop surface before cooking.

Metal Marks and Scratches

⚠ CAUTION

- Cookware with rough or uneven bottoms can mark or scratch the cooktop surface.

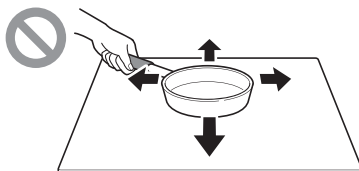

- Do not slide metal or glass across the cooktop surface.
- Do not use cookware with any dirt build-up on the bottom.

NOTE

- Any damage or failure of the product resulting from the items below may not be covered under the LIMITED WARRANTY.
 - Be careful not to slide pots and pans across the cooktop. Doing so will leave metal markings on the cooktop surface. To help remove these marks, use a ceramic cooktop cleaner with a cleaning pad for ceramic cooktops.
 - If pots with a thin overlay of aluminum or copper are allowed to boil dry, the overlay may leave a black discoloration on the cooktop. This should be removed immediately before heating again or the discoloration may be permanent.

TROUBLESHOOTING

Before Calling for Service

Before calling for service, review this list. It may save you time and expense. This list includes common occurrences that are not the result of a defect in workmanship or materials.

Parts and Features

Problem	Possible Cause & Solution
Cooktop does not work	Cooktop controls are locked. <ul style="list-style-type: none"> See Clean Lock to turn off the Clean Lock feature.
	Circuit breaker has tripped or fuse is blown. <ul style="list-style-type: none"> Reset the circuit breaker.
	Power outage. <ul style="list-style-type: none"> Check house lights to confirm power outage.
	Installation wiring not complete. <ul style="list-style-type: none"> Contact the installer or dealer.
Cooktop does not heat	Incorrect cooking zone selected. <ul style="list-style-type: none"> Make sure the correct control is ON for the cooking zone being used.
	No power to cooktop. <ul style="list-style-type: none"> See "Cooktop does not work" above.
Elements turn off while cooking.	Cooktop inner temperature is too high. <ul style="list-style-type: none"> Check that cooktop has been installed according to the installation instructions.
Elements do not get hot enough.	Control panel may not be set properly. <ul style="list-style-type: none"> Check the power level.
	Cookware that is not marked IH or convection compatible may not heat properly. <ul style="list-style-type: none"> Use cookware with the IH mark.
	Cookware may not be flat or the correct shape or size. <ul style="list-style-type: none"> Use cookware with a flat bottom. Minimum cookware size <ul style="list-style-type: none"> - Use cookware with a bottom surface diameter of 5 13/16" (147 mm) or greater. - For Flexible Cooking Zone, minimum cookware size is 4 3/4" x 10 5/8" (120 mm x 270 mm) For best results when using the Dual cooking zone, use cookware with a bottom surface that is 9" in diameter or larger. Use the recommended cookware. See Induction Cookware.
A fan sound can be heard.	Cooktop inner temperature is high. <ul style="list-style-type: none"> This is normal. <p>The cooling fan will run when any element is turned on. With heavy use the fan may continue to run after the controls are turned off until the cooktop has cooled.</p>
Noises are heard during cooking. The following noises are normal.	Humming/buzzing sound <ul style="list-style-type: none"> Caused by the magnetic field transmitting power to the cookware. It is most noticeable at high power settings and becomes quieter if the power is reduced.

38 TROUBLESHOOTING

Problem	Possible Cause & Solution
Noises are heard during cooking. The following noises are normal.	Whistling sound <ul style="list-style-type: none"> • Most noticeable with lighter weight cookware or when cookware is empty. • Under certain conditions, your cookware may produce a high-pitched whistling noise when two elements are in use at the same time. The power levels at which this occurs may vary depending on the kind of cookware being used. Change the power level to eliminate the noise or reduce its volume.
	Cracking sound <ul style="list-style-type: none"> • May occur when using composite cookware as the different materials resonate and heat at different rates. This will not damage or impair the performance of the cookware.
	Clicking sound <ul style="list-style-type: none"> • Caused by the electrical switches. • It is normal to hear a clicking noise when operating burners below power level 6.
	Ticking sound <ul style="list-style-type: none"> • Caused by the cookware detection.
The Boost function has been deactivated or cannot be activated.	To prevent damage to the product, if one of the right-side elements is turned on when the center dual element is using the Boost setting, the power setting of the center dual element is automatically reduced to power level 9. <ul style="list-style-type: none"> • To maintain the Boost setting on the center dual element, use any of the left side elements instead. • For safety, after 6 minutes the Boost setting will automatically revert to either power level 9 or the previously set power level.
The cookware cannot be detected automatically.	There is no cookware on the burner. <ul style="list-style-type: none"> • Place cookware on the burner. The words "Auto Detected" will be displayed.
	Cookware is not compatible with induction cooktop. <ul style="list-style-type: none"> • Use only cookware that is compatible with the induction cooktop. For details of compatible cookware, see Induction Cookware
Cookware has been damaged.	Cookware is overheated. <ul style="list-style-type: none"> • Never use the Boost mode to preheat empty cookware or to heat oil, butter or lard. • Use the Boost function to boil water or heat up large quantities of food quickly.
Output power is different when the same type of burner is used.	Cooktop is overheated. <ul style="list-style-type: none"> • The power level displayed may be different from the actual power level at the high end of the temperature range. To prevent the cooktop from overheating, the power level is controlled automatically.
Power cycling	This is normal. <ul style="list-style-type: none"> • During use, the heating element cycles on/off to control the output power.
The LCD screen does not work properly.	Hot cookware is placed on top of the LCD screen. <ul style="list-style-type: none"> • To prevent malfunction, do not place hot cookware on top of the LCD screen.
	It may not be operated by touch sensitivity. <ul style="list-style-type: none"> • Press the correct button firmly.
Timer does not turn off the cooking zone.	This is normal. <ul style="list-style-type: none"> • The kitchen timer/cooking timer acts as a simple timer and does not turn off the cooking zone.
The hot surface indicator stays on after the burners are turned off.	This is normal. <ul style="list-style-type: none"> • After you turn off the burners, the indicator remains on until the ceramic glass surface cools down. • If the temperature near the product is high, it may take longer for the ceramic glass surface to cool down.

Problem	Possible Cause & Solution
Error code FC, F1, or F5 appears on the display.	<p>Electronic control has detected a fault condition.</p> <ul style="list-style-type: none"> • Turn the power off and then on again to turn off the error code. • If the issue recurs, call for service.

Wi-Fi

Problem	Possible Cause & Solution
Trouble connecting appliance and smartphone to Wi-Fi network	<p>The password for the Wi-Fi network was entered incorrectly.</p> <ul style="list-style-type: none"> • Delete your home Wi-Fi network and begin the connection process again.
	<p>Mobile data for your smartphone is turned on.</p> <ul style="list-style-type: none"> • Turn off the Mobile data on your smartphone before connecting the appliance.
	<p>The wireless network name (SSID) is set incorrectly.</p> <ul style="list-style-type: none"> • The wireless network name (SSID) should be a combination of English letters and numbers. (Do not use special characters.)
	<p>The router frequency is not 2.4 GHz.</p> <ul style="list-style-type: none"> • Only a 2.4 GHz router frequency is supported. Set the wireless router to 2.4 GHz and connect the appliance to the wireless router. To check the router frequency, check with your Internet service provider or the router manufacturer.
	<p>The appliance and the router are too far apart.</p> <ul style="list-style-type: none"> • If the appliance is too far from the router, the signal may be weak and the connection may not be configured correctly. Move the router closer to the appliance or purchase and install a Wi-Fi repeater.
	<p>During Wi-Fi setup, the app is requesting a password to connect to the product (on certain phones).</p> <ul style="list-style-type: none"> • Locate the network name which starts with "LG" under Settings > Networks. Note the last part of the network name. <ul style="list-style-type: none"> - If the network name looks like LGE_Appliance_XX-XX-XX, enter lge12345. - If the network name looks like LGE_Appliance_XXXX, enter XXXX twice as your password. For example, if the network name appears as LGE_Appliance_8b92, then you would enter 8b928b92 as your password. In this instance, the password is case sensitive and the last 4 characters are unique to your appliance.

40 LIMITED WARRANTY

LIMITED WARRANTY**USA****TERMS AND CONDITIONS**

ARBITRATION NOTICE: THIS LIMITED WARRANTY CONTAINS AN ARBITRATION PROVISION THAT REQUIRES YOU AND LG ELECTRONICS (“LG”) TO RESOLVE DISPUTES BY BINDING ARBITRATION INSTEAD OF IN COURT, UNLESS YOU CHOOSE TO OPT OUT. IN ARBITRATION, CLASS ACTIONS AND JURY TRIALS ARE NOT PERMITTED. PLEASE SEE THE SECTION TITLED “PROCEDURE FOR RESOLVING DISPUTES” BELOW.

Should your LG Induction Cooktop (“Product”) fail due to a defect in materials or workmanship under normal and proper use, during the warranty period set forth below, LG will, at its option, repair or replace the Product. This limited warranty is valid only to the original retail purchaser of the Product (“You”) and applies only when purchased lawfully and used within the United States including U.S. Territories.

Warranty Period	Scope of Warranty	HOW SERVICE IS HANDLED
Two (2) years from date of original retail purchase	Parts and Labor (internal / functional parts only)	LG will provide, free of charge, all labor and in-home service to replace defective part(s).

- Replacement Products and parts are warranted for the remaining portion of the original warranty period or ninety (90) days, whichever is greater.
- Replacement Products and parts may be new, reconditioned, refurbished, or otherwise factory remanufactured.
- Replaced Product or part(s) will be the property of LG.
- Proof of original retail purchase specifying the Product model and date of purchase is required to obtain warranty service under this limited warranty.

EXCEPT TO THE EXTENT PROHIBITED BY APPLICABLE LAW, ANY IMPLIED WARRANTY OF MERCHANTABILITY OR FITNESS FOR A PARTICULAR PURPOSE ON THE PRODUCT IS LIMITED IN DURATION TO THE DURATION OF THE ABOVE LIMITED WARRANTY. UNDER NO CIRCUMSTANCES SHALL LG OR ITS U.S. DISTRIBUTORS/DEALERS BE LIABLE FOR ANY INDIRECT, INCIDENTAL, CONSEQUENTIAL, SPECIAL, OR PUNITIVE DAMAGES, INCLUDING, WITHOUT LIMITATION, LOST GOODWILL, LOST REVENUES OR PROFITS, WORK STOPPAGE, IMPAIRMENT OF OTHER GOODS, COST OF REMOVAL AND REINSTALLATION OF THE PRODUCT, LOSS OF USE, OR ANY OTHER DAMAGES WHETHER BASED IN CONTRACT, TORT, OR OTHERWISE. LG’S TOTAL LIABILITY, IF ANY, SHALL NOT EXCEED THE PURCHASE PRICE PAID BY YOU FOR THE PRODUCT.

SOME STATES DO NOT ALLOW THE EXCLUSION OR LIMITATION OF INCIDENTAL OR CONSEQUENTIAL DAMAGES OR LIMITATIONS ON HOW LONG AN IMPLIED WARRANTY LASTS, SO THE ABOVE EXCLUSIONS OR LIMITATIONS MAY NOT APPLY TO YOU. THIS LIMITED WARRANTY GIVES YOU SPECIFIC LEGAL RIGHTS AND YOU MAY ALSO HAVE OTHER RIGHTS THAT VARY FROM STATE TO STATE.

THIS LIMITED WARRANTY DOES NOT COVER:

- Service trips to deliver, pick up, or install, educate how to operate, correct wiring, or correct unauthorized repairs.
- Damage or failure of the Product to perform during power failures and interrupted or inadequate electrical service.
- Damage or failure of the Product caused by leaky or broken water pipes, frozen water pipes, restricted drain lines, inadequate or interrupted water supply or inadequate supply of air.
- Damage or failure of the Product resulting from operating the Product in a corrosive atmosphere or contrary to the Product owner’s manual.

- Damage or failure of the Product caused by accidents, pests and vermin, lightning, wind, fire, floods, acts of nature, or any other causes beyond the control of LG.
- Damage or failure of the Product caused by unauthorized modification or alteration, or if the Product is used for other than the intended purpose, or any water leakage where the Product was not properly installed.
- Damage or failure of the Product caused by incorrect electrical current, voltage, or plumbing codes.
- Damage or failure of the Product caused by transportation, storage, and/or handling, including scratches, dents, chips, and/or other damage to the finish of the Product, unless such damage is reported within one (1) week of delivery.
- Damage or failure of the Product resulting from misuse, abuse, improper installation, repair, or maintenance. Improper repair includes the use of parts not authorized by LG. Improper installation or maintenance includes installation or maintenance contrary to the Product owner's manual.
- Damage or failure of the Product caused by the use of parts, components, accessories, consumable cleaning products, or any other products or services that were not authorized by LG.
- Damage or missing items to any display or open box Product.
- Refurbished Product or any Product sold "As Is", "Where Is", "With all Faults", or similar disclaimer.
- Products with original serial numbers that have been removed, altered, or cannot be readily determined.
- Increases in utility costs and additional utility expenses.
- Any noises associated with normal operation.
- Products used for other than normal and proper household use (e.g., commercial or industrial use) or contrary to the Product owner's manual.
- Costs associated with removal and reinstallation of the Product for repairs, or the removal and reinstallation of the Product if it is installed in an inaccessible location or not installed in accordance with the Product Owner's manual.
- Accessories, removable components, or consumable parts (e.g. Shelves, door bins, drawers, water/air filters, racks, light bulbs, batteries, etc., as applicable), except for internal/functional parts covered under this limited warranty.

The cost of repair or replacement under these excluded circumstances shall be borne by You.

TO OBTAIN WARRANTY SERVICE AND ADDITIONAL INFORMATION

Call [1-800-243-0000](tel:1-800-243-0000) and select the appropriate option from the menu.

Or visit our website at <http://www.lg.com>

Or by mail: LG Electronics Customer Service P.O. Box 240007 Huntsville, AL 35813 ATTN: CIC

PROCEDURE FOR RESOLVING DISPUTES:

ALL DISPUTES BETWEEN YOU AND LG ARISING OUT OF OR RELATING IN ANY WAY TO THIS LIMITED WARRANTY OR THE PRODUCT SHALL BE RESOLVED EXCLUSIVELY THROUGH BINDING ARBITRATION, AND NOT IN A COURT OF GENERAL JURISDICTION. BINDING ARBITRATION MEANS THAT YOU AND LG ARE EACH WAIVING THE RIGHT TO A JURY TRIAL AND TO BRING OR PARTICIPATE IN A CLASS ACTION.

Definitions. For the purposes of this section, references to "LG" mean LG Electronics U.S.A., Inc., its parents, subsidiaries and affiliates, and each of their officers, directors, employees, agents, beneficiaries, predecessors in interest, successors, assigns and suppliers; references to "dispute" or "claim" shall include any dispute, claim or controversy of any kind whatsoever (whether based in contract, tort, statute, regulation, ordinance, fraud, misrepresentation or any other legal or equitable theory) arising out of or relating in any way to the sale, condition or performance of the product or this Limited Warranty.

Notice of Dispute. In the event you intend to commence an arbitration proceeding, you must first notify LG in writing at least 30 days in advance of initiating the arbitration by sending a letter to LG at LG Electronics, USA, Inc. Attn: Legal Department- Arbitration 111 Sylvan Avenue, Englewood Cliffs, NJ 07632. You and LG agree to engage in good faith discussions in an attempt to amicably resolve your claim. The notice must provide your name, address, and telephone number; identify the product that is the subject of

42 LIMITED WARRANTY

the claim; and describe the nature of the claim and the relief being sought. If you and LG are unable to resolve the dispute within 30 days, either party may proceed to file a claim for arbitration.

Agreement to Binding Arbitration and Class Action Waiver. Upon failure to resolve the dispute during the 30 day period after sending written notice to LG, you and LG agree to resolve any claims between us only by binding arbitration on an individual basis, unless you opt out as provided below. Any dispute between you and LG shall not be combined or consolidated with a dispute involving any other person's or entity's product or claim. More specifically, without limitation of the foregoing, any dispute between you and LG shall not under any circumstances proceed as part of a class or representative action. Instead of arbitration, either party may bring an individual action in small claims court, but that small claims court action may not be brought on a class or representative basis.

Arbitration Rules and Procedures. To begin arbitration of a claim, either you or LG must make a written demand for arbitration. The arbitration will be administered by the American Arbitration Association ("AAA") and will be conducted before a single arbitrator under the AAA's Consumer Arbitration Rules that are in effect at the time the arbitration is initiated (referred to as the "AAA Rules") and under the procedures set forth in this section. The AAA Rules are available online at www.adr.org/consumer. Send a copy of your written demand for arbitration, as well as a copy of this provision, to the AAA in the manner described in the AAA Rules. You must also send a copy of your written demand to LG at LG Electronics, USA, Inc. Attn: Legal Department- Arbitration 111 Sylvan Avenue, Englewood Cliffs, NJ 07632. If there is a conflict between the AAA Rules and the rules set forth in this section, the rules set forth in this section will govern. This arbitration provision is governed by the Federal Arbitration Act. Judgment may be entered on the arbitrator's award in any court of competent jurisdiction. All issues are for the arbitrator to decide, except that issues relating to the scope and enforceability of the arbitration provision and to the arbitrability of the dispute are for the court to decide. The arbitrator is bound by the terms of this provision.

Governing Law. The law of the state of your residence shall govern this Limited Warranty and any disputes between us except to the extent that such law is preempted by or inconsistent with applicable federal law.

Fees/Costs. You do not need to pay any fee to begin an arbitration. Upon receipt of your written demand for arbitration, LG will promptly pay all arbitration filing fees to the AAA unless you seek more than \$25,000 in damages, in which case the payment of these fees will be governed by the AAA Rules. Except as otherwise provided for herein, LG will pay all AAA filing, administration and arbitrator fees for any arbitration initiated in accordance with the AAA Rules and this arbitration provision. If you prevail in the arbitration, LG will pay your attorneys' fees and expenses as long as they are reasonable, by considering factors including, but not limited to, the purchase amount and claim amount. Notwithstanding the foregoing, if applicable law allows for an award of reasonable attorneys' fees and expenses, an arbitrator can award them to the same extent that a court would. If the arbitrator finds either the substance of your claim or the relief sought in the demand is frivolous or brought for an improper purpose (as measured by the standards set forth in Federal Rule of Civil Procedure 11(b)), then the payment of all arbitration fees will be governed by the AAA Rules. In such a situation, you agree to reimburse LG for all monies previously disbursed by it that are otherwise your obligation to pay under the AAA Rules. Except as otherwise provided for, LG waives any rights it may have to seek attorneys' fees and expenses from you if LG prevails in the arbitration.

Hearings and Location. If your claim is for \$25,000 or less, you may choose to have the arbitration conducted solely on the basis of (1) documents submitted to the arbitrator, (2) through a telephonic hearing, or (3) by an in-person hearing as established by the AAA Rules. If your claim exceeds \$25,000, the right to a hearing will be determined by the AAA Rules. Any in-person arbitration hearings will be held at a location within the federal judicial district in which you reside unless we both agree to another location or we agree to a telephonic arbitration.

Opt Out. You may opt out of this dispute resolution procedure. If you opt out, neither you nor LG can require the other to participate in an arbitration proceeding. To opt out, you must send notice to LG no later than 30 calendar days from the date of the first consumer purchaser's purchase of the product by either: (i) sending an e-mail to optout@lge.com, with the subject line: "Arbitration Opt Out" or (ii) calling [1-800-980-2973](tel:1-800-980-2973). You must include in the opt out e-mail or provide by telephone: (a) your name and address; (b) the date on which the product was purchased; (c) the product model name or model number; and (d) the serial number (the serial number can be found (i) on the product; or (ii) online by accessing <https://www.lg.com/us/support/repair-service/schedule-repair-continued> and clicking on "Find My Model & Serial Number").

You may only opt out of the dispute resolution procedure in the manner described above (that is, by e-mail or telephone); no other form of notice will be effective to opt out of this dispute resolution procedure. Opting out of this dispute resolution procedure will not affect the coverage of the Limited Warranty in any way, and you will continue to enjoy the full benefits of the Limited Warranty. If you keep this product and do not opt out, then you accept all terms and conditions of the arbitration provision described above.

ENGLISH

44 LIMITED WARRANTY

CANADA

TERMS AND CONDITIONS

ARBITRATION NOTICE: THIS LIMITED WARRANTY CONTAINS AN ARBITRATION PROVISION THAT REQUIRES YOU AND LG TO RESOLVE DISPUTES BY BINDING ARBITRATION INSTEAD OF IN COURT, UNLESS THE LAWS OF YOUR PROVINCE OR TERRITORY DO NOT PERMIT THAT, OR, IN OTHER JURISDICTIONS, IF YOU CHOOSE TO OPT OUT. IN ARBITRATION, CLASS ACTIONS AND JURY TRIALS ARE NOT PERMITTED. PLEASE SEE THE SECTION TITLED "PROCEDURE FOR RESOLVING DISPUTES" BELOW.

Should your LG Induction Cooktop ("Product") fail due to a defect in materials or workmanship under normal and proper use, during the warranty period set forth below, LG Electronics Canada, Inc. ("LGECI") will, at its option, repair, replace or pro rate the Product upon receipt of proof of the original retail purchase. This limited warranty is valid only to the original retail purchaser of the Product and applies only to a Product distributed, purchased from an authorized retailer and used within Canada, as determined at the sole discretion of LGECI.

WARRANTY PERIOD: (Note: If the original date of purchase cannot be verified, the warranty will begin sixty (60) days from the date of manufacture).
--

Parts and Labor (internal/functional parts only)
--

Two (2) years from the date of original retail purchase

- Replacement products and parts are warranted for the remaining portion of the original warranty period or ninety (90) days, whichever is greater.
- Replacement products and parts may be new, reconditioned, refurbished, or otherwise factory remanufactured, all at the sole discretion of LGECI.
- Proof of original retail purchase specifying the Product model and date of purchase is required to obtain warranty service under this Limited Warranty.

LGECI'S SOLE LIABILITY IS LIMITED TO THE LIMITED WARRANTY SET OUT ABOVE. EXCEPT AS EXPRESSLY PROVIDED ABOVE, LGECI MAKES NO, AND HEREBY DISCLAIMS, ALL OTHER WARRANTIES AND CONDITIONS RESPECTING THE PRODUCT, WHETHER EXPRESS OR IMPLIED, INCLUDING BUT NOT LIMITED TO, ANY IMPLIED WARRANTY OR CONDITION OF MERCHANTABILITY OR FITNESS FOR A PARTICULAR PURPOSE, AND NO REPRESENTATIONS SHALL BE BINDING ON LGECI. LGECI DOES NOT AUTHORIZE ANY PERSON TO CREATE OR ASSUME FOR IT ANY OTHER WARRANTY OBLIGATION OR LIABILITY IN CONNECTION WITH THE PRODUCT. TO THE EXTENT THAT ANY WARRANTY OR CONDITION IS IMPLIED BY LAW, IT IS LIMITED TO THE WARRANTY PERIOD SET OUT ABOVE. UNDER NO CIRCUMSTANCES SHALL LGECI, THE MANUFACTURER OR DISTRIBUTOR OF THE PRODUCT, BE LIABLE FOR ANY INCIDENTAL, CONSEQUENTIAL, SPECIAL, DIRECT, INDIRECT, PUNITIVE OR EXEMPLARY DAMAGES, INCLUDING, WITHOUT LIMITATION, LOSS OF GOODWILL, LOST PROFITS, LOSS OF ANTICIPATED PROFITS, LOST REVENUE, LOSS OF USE, OR ANY OTHER DAMAGE, WHETHER ARISING DIRECTLY OR INDIRECTLY FROM ANY CONTRACTUAL BREACH, FUNDAMENTAL BREACH, TORT OR OTHERWISE, OR FROM ANY ACTS OR OMISSIONS. LGECI'S TOTAL LIABILITY, IF ANY, SHALL NOT EXCEED THE PURCHASE PRICE PAID BY YOU FOR THE PRODUCT.

This Limited Warranty gives you specific legal rights. You may also have other rights that vary from province to province depending on applicable provincial laws. Any term of this Limited Warranty that negates or varies any implied condition or warranty under provincial law is severable where it conflicts with such provincial law without affecting the remainder of this warranty's terms.

THIS LIMITED WARRANTY DOES NOT COVER:

- Service trips to i) deliver, pick up, or install or; educate on how to operate the Product; ii) correct wiring or plumbing; or iii) correct unauthorized repairs or installations of the Product;
- Damage or failure of the Product to perform during power failures and interrupted or inadequate electrical service;

- Damage or failure caused by leaky or broken water pipes, frozen water pipes, restricted drain lines, inadequate or interrupted water supply or inadequate supply of air;
- Damage or failure resulting from operating the Product in a corrosive atmosphere or contrary to the instructions outlined in the Product's owner's manual;
- Damage or failure to the Product caused by accidents, pests and vermin, lightning, wind, fire, floods, acts of God, or any other causes beyond the control of LGECI or the manufacturer;
- Damage or failure resulting from misuse, abuse, improper installation, repair, or maintenance of the Product. Improper repair includes use of parts not authorized or specified by LGECI. Improper installation or maintenance includes installation or maintenance contrary to the Product's owner's manual;
- Damage or failure caused by unauthorized modification or alteration of the Product, or if used for other than the intended household purpose/use of the Product, or damage or failure resulting from any water leakage due to improper installation of the Product;
- Damage or failure caused by incorrect electrical current, voltage or plumbing codes;
- Damage or failure caused by use that is other than normal household use, including, without limitation, commercial or industrial use, including use in commercial offices or recreational facilities, or as otherwise outlined in the Product's owner's manual;
- Damage or failure caused by the use of any accessories, components or cleaning products, including, without limitation, water filters, that are not approved/authorized by LGECI;
- Damage or failure caused by transportation and handling, including scratches, dents, chips and/or other damage to the finish of the Product, unless such damage results from defects in materials or workmanship and is reported to LGECI within one (1) week of delivery of the Products;
- Damage or missing items to any display, open box, refurbished or discounted Product;
- Refurbished Product or any Product sold "As Is", "Where Is", "With all Faults", or any similar disclaimer;
- Products with original serial numbers that have been removed, altered or cannot be readily determined at the discretion of LGECI;
- Increases in utility costs and additional utility expenses in any way associated with the Product;
- Any noises associated with normal operation of the Product;
- Replacement of any part that was not originally included with the Product;
- Replacement of light bulbs, filters, fuses or any other consumable parts;
- Costs associated with removal and/or reinstallation of the Product for repairs; and
- Shelves, door bins, drawers, handle and accessories to the Product, except for internal/functional parts covered under this Limited Warranty.
- Coverage for "in Home" repairs, for products in-warranty, will be provided if the Product is within a 150 km radius from the nearest authorized service center (ASC), as determined by LG Canada. If your Product is located outside a 150 km radius from a ASC, as determined by LG Canada, it will be your responsibility to bring the Product, at your sole expense, to the ASC for in-warranty repair.

All costs and expenses associated with the above excluded circumstances, listed under the heading, This Limited Warranty Does Not Cover, shall be borne by the consumer.

TO OBTAIN WARRANTY SERVICE AND ADDITIONAL INFORMATION, PLEASE CALL OR VISIT OUR WEBSITE:

Call [1-888-542-2623](tel:1-888-542-2623) (7 A.M. to 12 A.M., 365 days a year) and select the appropriate option from the menu, or visit our website at <http://www.lg.com>

PROCEDURE FOR RESOLVING DISPUTES:

EXCEPT WHERE PROHIBITED AT LAW, ALL DISPUTES BETWEEN YOU AND LG ARISING OUT OF OR RELATING IN ANY WAY TO THIS LIMITED WARRANTY OR THE PRODUCT SHALL BE RESOLVED EXCLUSIVELY THROUGH BINDING ARBITRATION, AND NOT IN A COURT OF GENERAL JURISDICTION. EXCEPT WHERE PROHIBITED AT LAW, YOU AND LG BOTH IRREVOCABLY AGREE TO WAIVE THE RIGHT TO A JURY TRIAL AND TO BRING OR PARTICIPATE IN A CLASS ACTION.

46 LIMITED WARRANTY

Definitions. For the purposes of this section, references to “LG” mean LG Electronics Canada, Inc., its parents, subsidiaries and affiliates, and each of their officers, directors, employees, agents, beneficiaries, predecessors in interest, successors, assigns and suppliers; references to “dispute” or “claim” shall include any dispute, claim or controversy of any kind whatsoever (whether based in contract, tort, statute, regulation, ordinance, fraud, misrepresentation or any other legal or equitable theory) arising out of or relating in any way to the sale, condition or performance of the product or this Limited Warranty.

Notice of Dispute. In the event you intend to commence an arbitration proceeding, you must first notify LG in writing at least 30 days in advance of initiating the arbitration by sending a letter to LGECI Legal Team at 20 Norelco Drive, North York, Ontario, Canada M9L 2X6 (the “Notice of Dispute”). You and LG agree to engage in good faith discussions in an attempt to amicably resolve your claim. The notice must provide your name, address, and telephone number; identify the product that is the subject of the claim; and describe the nature of the claim and the relief being sought. If you and LG are unable to resolve the dispute within 30 days of LG’s receipt of the Notice of Dispute, the dispute shall be resolved by binding arbitration in accordance with the procedure set out herein. You and LG both agree that, during the arbitration proceeding, the terms (including any amount) of any settlement offer made by either you or LG will not be disclosed to the arbitrator until the arbitrator determines the dispute.

Agreement to Binding Arbitration and Class Action Waiver. Upon failure to resolve the dispute during the 30 day period after LG’s receipt of the Notice of Dispute, you and LG agree to resolve any claims between you and LG only by binding arbitration on an individual basis, unless you opt out as provided below, or you reside in a jurisdiction that prevents full application of this clause in the circumstances of the claims at issue (in which case if you are a consumer, this clause will only apply if you expressly agree to the arbitration). To the extent permitted by applicable law, any dispute between you and LG shall not be combined or consolidated with a dispute involving any other person’s or entity’s product or claim. More specifically, without limitation of the foregoing, except to the extent such a prohibition is not permitted at law, any dispute between you and LG shall not under any circumstances proceed as part of a class or representative action. Instead of arbitration, either party may bring an individual action in small claims court, but that small claims court action may not be brought on a class or representative basis except to the extent this prohibition is not permitted at law in your province or territory of jurisdiction as it relates to the claims at issue between you and LG.

Arbitration Rules and Procedures. To begin arbitration of a claim, either you or LG must make a written demand for arbitration. The arbitration will be private and confidential, and conducted on a simplified and expedited basis before a single arbitrator chosen by the parties under the provincial or territorial commercial arbitration law and rules of the province or territory of your residence. You must also send a copy of your written demand to LG at LG Electronics, Canada, Inc., Attn: Legal Department- Arbitration, 20 Norelco Drive, North York, Ontario M9L 2X6. This arbitration provision is governed by your applicable provincial or territorial commercial arbitration legislation. Judgment may be entered on the arbitrator’s award in any court of competent jurisdiction. All issues are for the arbitrator to decide, except that, issues relating to the scope and enforceability of the arbitration provision and to the arbitrability of the dispute are for the court to decide. The arbitrator is bound by the terms of this provision.

Governing Law. The law of the province or territory of your purchase shall govern this Limited Warranty and any disputes between you and LG except to the extent that such law is preempted by or inconsistent with applicable federal or provincial/territorial law. Should arbitration not be permitted for any claim, action, dispute or controversy between you and LG, you and LG attorn to the exclusive jurisdiction of the courts of the province or territory of your purchase for the resolution of the claim, action, dispute or controversy between you and LG.

Fees/Costs. You do not need to pay any fee to begin an arbitration. Upon receipt of your written demand for arbitration, LG will promptly pay all arbitration filing fees unless you seek more than \$25,000 in damages, in which case the payment of these fees will be governed by the applicable arbitration rules. Except as otherwise provided for herein, LG will pay all filing, administration and arbitrator fees for any arbitration initiated in accordance with the applicable arbitration rules and this arbitration provision. If you prevail in the arbitration, LG will pay your attorneys’ fees and expenses as long as they are reasonable, by considering factors including, but not limited to, the purchase amount and claim amount. Notwithstanding the foregoing, if applicable law allows for an award of reasonable attorneys’ fees and expenses, an arbitrator can award them to the same extent that a court would. If the arbitrator finds either the substance of your claim or the relief sought in the demand is frivolous or brought for an improper purpose (as measured by the applicable laws), then the payment of all arbitration fees will be governed by the applicable arbitration rules. In such a situation, you agree to reimburse LG for all monies previously disbursed by it that are otherwise your obligation to pay under the applicable arbitration rules. Except as

otherwise provided for, LG waives any rights it may have to seek attorneys' fees and expenses from you if LG prevails in the arbitration.

Hearings and Location. If your claim is for \$25,000 or less, you may choose to have the arbitration conducted solely (1) on the basis of documents submitted to the arbitrator, (2) through a telephonic hearing, or (3) by an in-person hearing as established by the applicable arbitration rules. If your claim exceeds \$25,000, the right to a hearing will be determined by the applicable arbitration rules. Any in-person arbitration hearings will be held at the nearest, most mutually-convenient arbitration location available within the province or territory in which you reside unless you and LG both agree to another location or agree to a telephonic arbitration.

Severability and Waiver. If any portion of this Limited Warranty (including these arbitration procedures) is unenforceable, the remaining provisions will continue in full force and effect to the maximum extent permitted by applicable law. Should LG fail to enforce strict performance of any provision of this Limited Warranty (including these arbitration procedures), it does not mean that LG intends to waive or has waived any provision or part of this Limited Warranty.

Opt Out. You may opt out of this dispute resolution procedure. If you opt out, neither you nor LG can require the other to participate in an arbitration proceeding. To opt out, you must send notice to LG no later than 30 calendar days from the date of the first consumer purchaser's purchase of the product by either (i) sending an e-mail to optout@lge.com, with the subject line: "Arbitration Opt Out;" or (ii) calling 1-800-980-2973. You must include in the opt out e-mail or provide by telephone: (a) your name and address; (b) the date on which the product was purchased; (c) the product model name or model number; and (d) the serial number (the serial number can be found (i) on the product; or (ii) online by accessing https://www.lg.com/ca_en/support/repair-service/schedule-repair and clicking on "Find My Model & Serial Number").

In the event that you "Opt Out", the law of the province or territory of your residence shall govern this Limited Warranty and any disputes between you and LG except to the extent that such law is preempted by or inconsistent with applicable federal or provincial/territorial law. Should arbitration not be permitted for any claim, action, dispute or controversy between you and LG, you and LG agree to attorn to the exclusive jurisdiction of the courts of the province or territory of your residence for the resolution of the claim, action, dispute or controversy between you and LG.

You may only opt out of the dispute resolution procedure in the manner described above (that is, by e-mail or telephone); no other form of notice will be effective to opt out of this dispute resolution procedure. Opting out of this dispute resolution procedure will not affect the coverage of the Limited Warranty in any way, and you will continue to enjoy the full benefits of the Limited Warranty. If you keep this product and do not opt out, then you accept all terms and conditions of the arbitration provision described above.

Conflict of Terms. In the event of a conflict or inconsistency between the terms of this Limited Warranty and the End User License Agreement ("EULA") in regards to dispute resolution, the terms of this Limited Warranty shall control and govern the rights and obligations of the parties and shall take precedence over the EULA.



LG Customer Information Center

For inquiries or comments,
visit www.lg.com or call:

1-800-2 **dummy** U.S.A.
1-888-542-2623 CANADA

Register your product Online!

www.lg.com