



C A F É

DISTINCT BY DESIGN

Owner's Manual



C A F É

DISTINCT BY DESIGN™

Owner's Manual

Radiant Cooktop

Models: CEP9030 and CEP9036

Contents

Safety Information	3	WiFi Commissioning	11
Using The Cooktop		Bluetooth® Pairing	11
Cooktop Features	5	Precision Cooking	12
Radiant Glass Cooktop	6	Custom Settings	13
Home Canning Tips	6	Griddle (optional accessory)	14
Cookware for Radiant Glass Cooktop	7	Care And Cleaning	
Element Cycling	8	Cleaning the Glass Cooktop	15
Operating the Cooking Elements	8	Troubleshooting Tips	16
Adjust Burner Size	8	Limited Warranty	18
Turn Burner(s) Off	9	Accessories	19
Selecting Cooktop Settings	9	Consumer Support	20
How to Synchronize Left Elements	9		
Cooktop Lockout	10		
Kitchen Timer	10		
Hot Light Indicator	10		

Write the model and serial numbers here:

Model # _____

Serial # _____

You can find them on a label under the cooktop.

English • Français • Español



THANK YOU FOR MAKING CAFÉ A PART OF YOUR HOME.

We take pride in the craftsmanship, innovation and design that goes into every CAFÉ product, and we think you will too. Among other things, registration of your appliance ensures that we can deliver important product information and warranty details when you need them.

Register your CAFÉ appliance now online. Helpful websites are available in the Consumer Support section of this Owner's Manual. You may also mail in the pre-printed registration card included in the packing material.

C A F É

DISTINCT BY DESIGN™

IMPORTANT SAFETY INFORMATION

READ ALL INSTRUCTIONS BEFORE USING THE APPLIANCE

▲WARNING Read all safety instructions before using the product. Failure to follow these instructions may result in fire, electrical shock, serious injury or death.

▲WARNING GENERAL SAFETY INSTRUCTIONS

- Use this cooktop only for its intended purpose as described in this Owner's Manual.
- Be sure your cooktop is properly installed and grounded by a qualified installer in accordance with the provided installation instructions.
- Do not attempt to repair or replace any part of your cooktop unless it is specifically recommended in this manual. All other servicing should be performed by a qualified technician.
- Before performing any service, unplug the cooktop or disconnect the power supply at the household distribution panel by removing the fuse or switching off the circuit breaker.
- Do not leave children alone—children should not be left alone or unattended in an area where the cooktop is in use. They should never be allowed to climb, sit or stand on any part of the cooktop.
- **▲CAUTION** Do not store items of interest to children above the cooktop—children climbing on the cooktop to reach items could be seriously injured.
- Use only dry pot holders—moist or damp pot holders on hot surfaces may result in burns from steam. Do not let pot holders touch hot surface units or heating elements. Do not use a towel or other bulky cloth in place of pot holders.
- Never use your cooktop for warming or heating the room.
- Do not touch surface elements. These surfaces may be hot enough to burn even though they are dark in color. During and after use, do not touch, or let clothing or other flammable materials contact the surface elements or areas nearby the surface elements; allow sufficient time for cooling first.
- Potentially hot surfaces include the cooktop and areas facing the cooktop.
- Do not heat unopened food containers. Pressure could build up and the container could burst, causing an injury.
- Cook meat and poultry thoroughly—meat to at least an internal temperature of 160°F and poultry to at least an internal temperature of 180°F. Cooking to these temperatures usually protects against foodborne illness.

▲WARNING KEEP FLAMMABLE MATERIALS AWAY FROM THE COOKTOP

Failure to do so may result in fire or personal injury.

- Do not store or use flammable materials near the cooktop, including paper, plastic, pot holders, linens, wall coverings, curtains, drapes and gasoline or other flammable vapors and liquids.
- Never wear loose-fitting or hanging garments while using the cooktop. These garments may ignite if they contact hot surfaces causing severe burns.
- Do not let cooking grease or other flammable materials accumulate in or near the cooktop. Grease on the cooktop may ignite.

READ AND SAVE THESE INSTRUCTIONS

IMPORTANT SAFETY INFORMATION

READ ALL INSTRUCTIONS BEFORE USING THE APPLIANCE

▲WARNING COOKTOP SAFETY INSTRUCTIONS

- In the event of a fire, do not use water or grease on fires. Never pick up a flaming pan. Turn the controls off. Smother a flaming pan on a surface unit by covering the pan completely with a well-fitted lid, cookie sheet or flat tray. Use a multi-purpose dry chemical or a foam-type fire extinguisher.
- Never leave the surface units unattended at medium or high heat settings. Boilovers cause smoking and greasy spillovers that may catch on fire.
- Never leave oil unattended while frying. If allowed to heat beyond its smoking point, oil may ignite resulting in fire that may spread to surrounding cabinets. Use a deep fat thermometer whenever possible to monitor oil temperature.
- To avoid spillover and fire, use a minimum amount of oil when shallow pan-frying and avoid cooking frozen foods with excessive amounts of ice.
- Use the proper pan size - select cookware having flat bottoms large enough to cover the surface heating element. The use of undersized cookware will expose a portion of the surface unit to direct contact and may result in ignition of clothing. Proper relationship of cookware to surface unit will also improve efficiency.
- To minimize the possibility of burns, ignition of flammable materials and spillage, the handle of a container should be turned toward the center of the range without extending over nearby surface units.

▲WARNING RADIANT COOKTOP SAFETY INSTRUCTIONS

- Only certain types of glass, glass/ceramic, earthenware or other glazed containers are suitable for cooktop service; others may break because of the sudden change in temperature.
- Use care when touching the cooktop. The glass surface of the cooktop will retain heat after the controls have been turned off.
- Do not cook on a broken cooktop. If the glass cooktop should break, cleaning solutions and spillovers may penetrate the broken cooktop and create a risk of electric shock. Contact a qualified technician immediately.
- Avoid scratching the glass cooktop. The cooktop can be scratched with items such as knives, sharp instruments, rings or other jewelry, and rivets on clothing.
- Do not place or store items that can melt or catch fire on the glass cooktop, even when it is not being used. If the cooktop is inadvertently turned on, they may ignite. Heat from the cooktop or oven vent after it is turned off may cause them to ignite also.
- Use a ceramic cooktop cleaner and a non-scratch cleaning pad to clean the cooktop. Wait until the cooktop cools and the indicator light goes out before cleaning. A wet sponge or cloth on a hot surface can cause steam burns. Some cleaners can produce noxious fumes if applied to a hot surface. Read and follow all instructions and warnings on the cleaning cream label. **NOTE:** Sugary spills are an exception. They should be scraped off while still hot using an oven mitt and a scraper. See the Cleaning the glass cooktop section for detailed instructions.

PROPER DISPOSAL OF YOUR APPLIANCE

Dispose of or recycle your appliance in accordance with Federal and Local Regulations. Contact your local authorities for the environmentally safe disposal or recycling of your appliance.

How to Remove Protective Shipping Film and Packaging Tape

Carefully grasp a corner of the protective shipping film with your fingers and slowly peel it from the appliance surface. Do not use any sharp items to remove the film. Remove all of the film before using the appliance for the first time.

To assure no damage is done to the finish of the product, the safest way to remove the adhesive from

packaging tape on new appliances is an application of a household liquid dishwashing detergent. Apply with a soft cloth and allow to soak.

NOTE: The adhesive must be removed from all parts. It cannot be removed if it is baked on.

Consider recycling options for your appliance packaging material.

READ AND SAVE THESE INSTRUCTIONS

Cooktop Features

Throughout this manual, features and appearance may vary from your model.

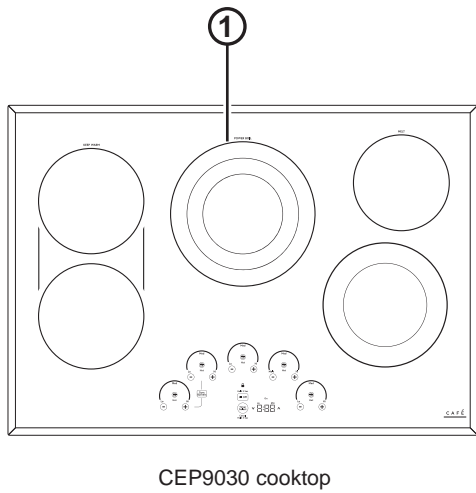

CEP9030 cooktop

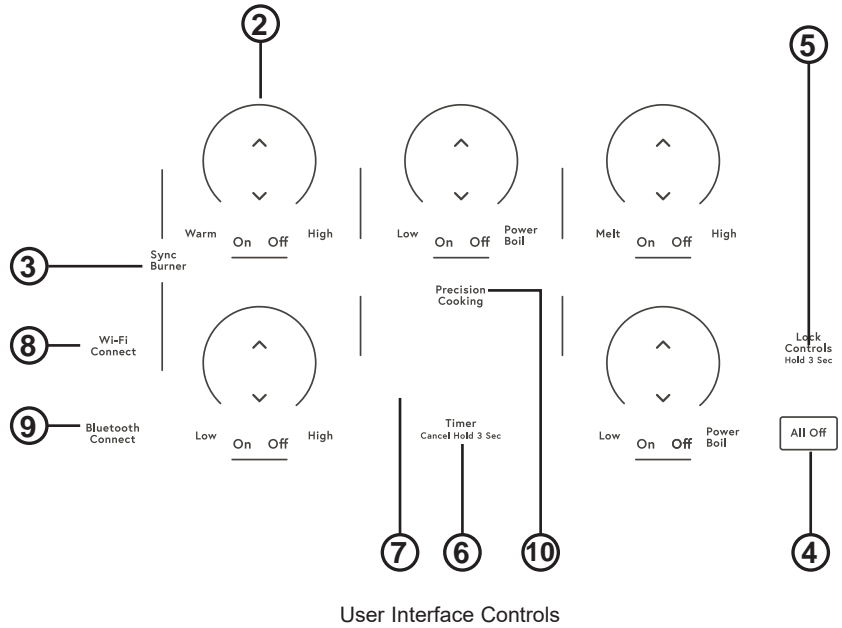

User Interface Controls

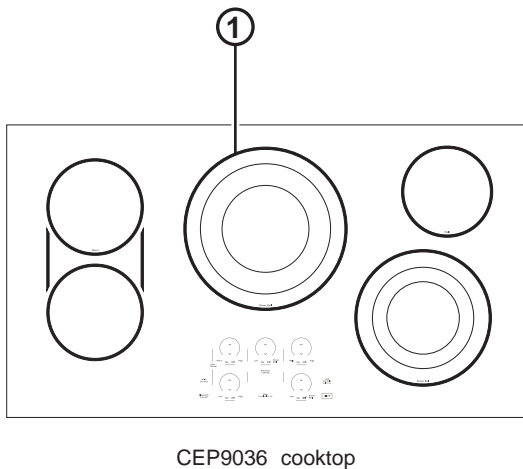

CEP9036 cooktop

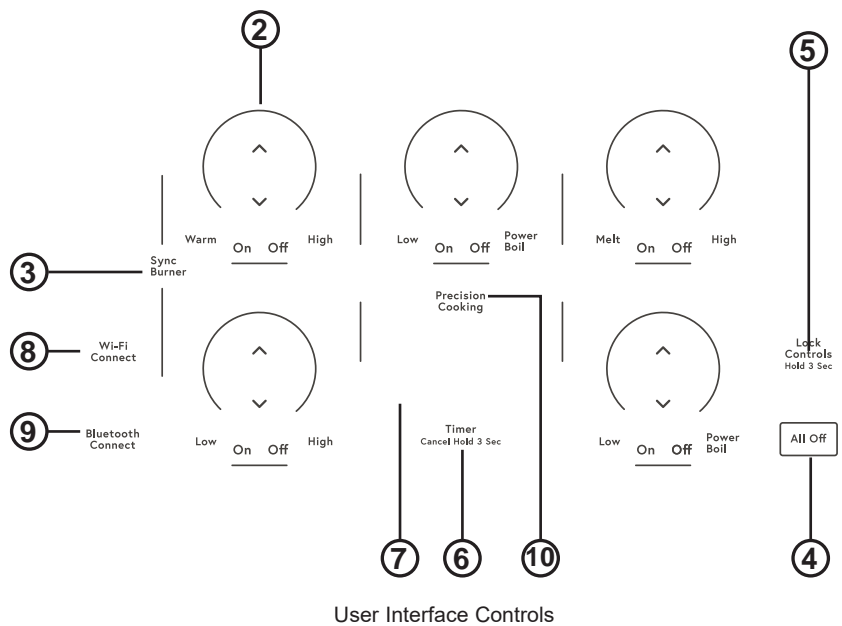

User Interface Controls

1. **Cooking Element(s):** See page 8.
2. **Power Level Arc:** See page 8.
3. **Sync Burners:** See page 9.
4. **All Off:** See page 9.
5. **Lock:** See page 10.
6. **Timer Select:** See page 10.
7. **Display:** See page 10.
8. **WiFi Connect:** See page 11.
9. **Bluetooth Connect:** See page 11.
10. **Precision Cooking:** See page 12.

Radiant Glass Cooktop

The radiant cooktop features heating units beneath a smooth glass surface.

NOTE: A slight odor is normal when a new cooktop is used for the first time. It is caused by the heating of new parts and insulating materials and will disappear in a short time.

NOTE: This cooktop has Rapid Response surface units. The cooktop will automatically heat up or cool down to the desired power level setting in the quickest time possible. While the surface units are on, you may not see them glow red during certain heat up or cool down conditions.

Cooktop temperatures increase with the number of surface units that are on. With 3 or 4 units turned on, surface temperatures are high. Always use caution when touching the cooktop.



Never cook directly on the glass.
Always use cookware.



Always place the pan in the center of the surface unit you are cooking on.



Do not slide cookware across the cooktop because it can scratch the glass—the glass is scratch-resistant, not scratch proof.

Home Canning Tips

Be sure the canner is centered over the surface unit.

Make sure the canner is flat on the bottom.

To prevent burns from steam or heat, use caution when canning.

Use recipes and procedures from reputable sources. These are available from manufacturers such as Ball® and Kerr® and the Department of Agriculture Extension Service.

Flat-bottomed canners are recommended. Use of water bath canners with rippled bottoms may extend the time required to bring the water to a boil.

Cookware for Radiant Glass Cooktop

The following information will help you choose cookware which will give good performance on glass cooktops.

NOTE: Follow all cookware manufacturer's recommendations when using any type of cookware on the ceramic cooktop.

Recommended

Stainless Steel

Aluminum:

Heavy weight recommended

Good conductivity. Aluminum residues sometimes appear as scratches on the cooktop but can be removed if cleaned immediately. Because of its low melting point, thin weight aluminum should not be used.

Copper Bottom:

Copper may leave residues which can appear as scratches. The residues can be removed, as long as the cooktop is cleaned immediately. However, do not let these pots boil dry. Overheated metal can bond to glass cooktops. An overheated copper bottom pot will leave a residue that will permanently stain the cooktop if not removed immediately.

Enamel (painted) on Cast Iron:

Recommended if bottom of pan is coated

Avoid/Not Recommended

Enamel (painted) on Steel:

Heating empty pans can cause permanent damage to cooktop glass. The enamel can melt and bond to the ceramic cooktop.

Glass-ceramic:

Poor performance. Will scratch the surface.

Stoneware:

Poor performance. May scratch the surface.

Cast Iron:

Not recommended—unless designed specifically for glass cooktops

Poor conductivity and slow to absorb heat. Will scratch the cooktop surface.

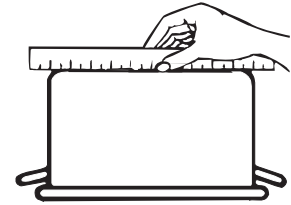

Check pans for flat bottoms by using a straight edge.

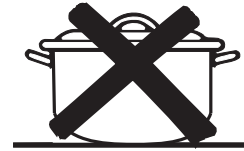

Pans with rounded, curved, ridged or warped bottoms are not recommended.

For Best Results

- Place only dry pans on the surface elements. Do not place lids on the surface elements, particularly wet lids. Wet pans and lids may stick to the surface when cool.
- Do not use woks that have support rings. This type of wok will not heat on glass surface elements.
- We recommend that you use only a flat-bottomed wok. They are available at your local retail store. The bottom of the wok should have the same diameter as the surface element to ensure proper contact.
- Some special cooking procedures require specific cookware such as pressure cookers or deep-fat fryers. All cookware must have flat bottoms and be the correct size.



Do not place wet pans on the glass cooktop.



Do not use woks with support rings on the glass cooktop.



Use flat-bottomed woks on the glass cooktop.

Element Cycling

Surface elements will cycle on and off to maintain the temperature you have selected. All radiant surface elements have a temperature limiter that protects the glass cooktop from getting too hot, this is normal. The temperature limiter may cycle the elements off more frequently if:

- The pan boils dry.
- The pan bottom is not flat.
- The pan is off-center.
- There is no pan on the element.

Operating The Cooking Elements

Turn Burner(s) On: Touch and hold **On/Off** pad about half a second. A chime can be heard with each touch to any pad.

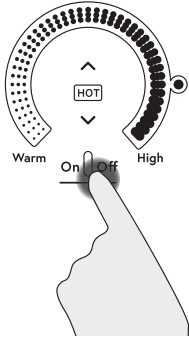

Power level can be selected in any of the following ways:

1. **Swipe the gray arc** to the desired power level.
2. Touch **Anywhere** along the gray arc, or;

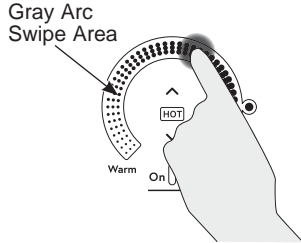

3. Touch **Λ** or **V** pads to adjust power level, or;

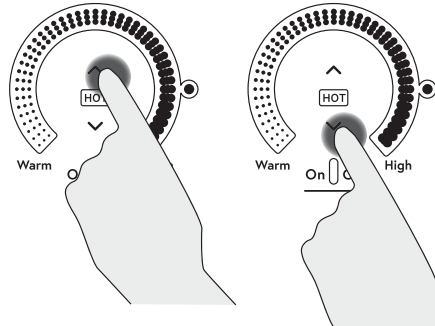

4. Shortcut to Hi: Immediately after turning unit on, touch the **Λ** pad, or;
5. Shortcut to Low: Immediately after turning unit on, touch the **V** pad.

Adjust Burner Size

The burner ring size is adjustable on some elements. The ring size can be selected by pressing the burner ring graphic.

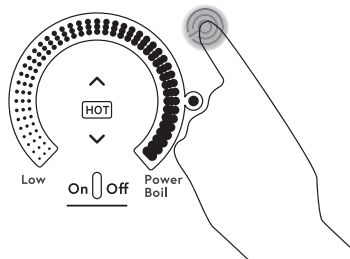

Single Surface Element

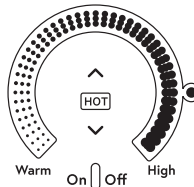

Dual Surface Element

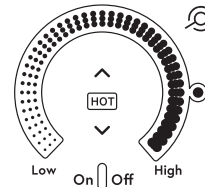

Tri-Ring Surface Element

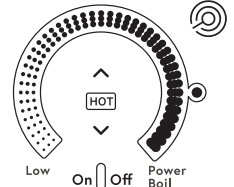

Turn Burner(s) Off

Touch **On/Off** pad for an individual burner or touch the **All Off** pad.

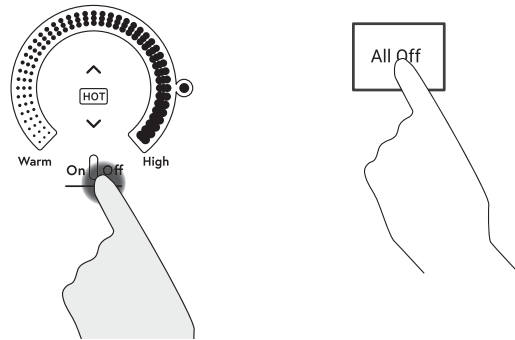

Selecting Cooktop Settings

Choose the element/burner that is best fit to the cookware size. Each element/burner on your new cooktop has its own power levels ranging from low to high. Power level settings necessary for cooking will vary depending on the cookware being used, the type and quantity of food, and the desired outcome. In general use lower settings for melting, holding and simmering and use higher settings for heating quickly, searing and frying. When keeping foods warm confirm selected setting is sufficient to maintain food temperature above 140°F. Larger elements and elements marked “Keep Warm” are not recommended for melting.

Hi is the highest power level, designed for large quantity rapid cooking and boiling. Hi will operate for a maximum of 10 minutes. Hi may be repeated after the initial 10 minute cycle by pressing the **▲** pad.

CAUTION Do not place any cookware, utensils or leave excess water spills on control key pads. This may result in unresponsive touch pads and turning off the cooktop if present for several seconds.

NOTE: The warm setting may not glow bright red like the other heating operations.

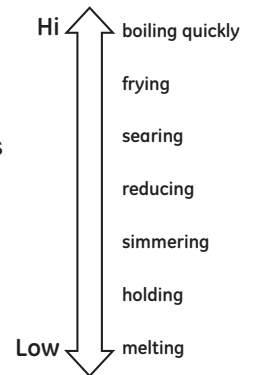

How To Synchronize Left Elements

To Turn On

Hold the **Sync Burners** pad for about half a second to connect the two burners. Operate either element as described on page 8 to adjust power level.

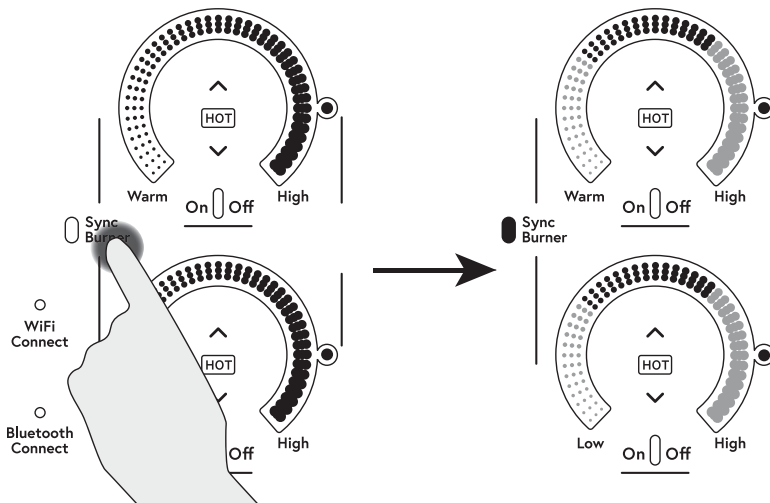

To Turn Off

1. Touch the **On/Off** pad on either burner to turn off the Sync Burners.
- or
2. Touch the **Sync Burners** to turn both burners off.

Cooktop Lockout

Lock

Touch **Control Lock** pad for 3 seconds.

Unlock

Touch **Control Lock** pad again for 3 seconds.

See Custom Settings section to activate Auto Lock feature.

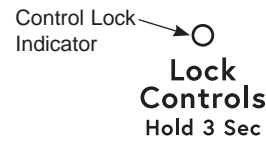

Cooktop Lockout: locks operation of the controls

Kitchen Timer

To Turn On

Touch the **Timer Select** pad. Touch the **▲** or **▼** arrows to choose the desired number of minutes. Timer automatically starts 10 seconds after pad is touched, or if the **Timer Select** pad it touched. The “ON” LED will appear automatically when timer is set.

To Turn Off

Press and release the Timer Select pad to cancel timer, or hold for 3 seconds. Alarm will sound continuously when time is up until user turns timer off.

NOTE: Use the kitchen timer to measure cooking time or as a reminder. The kitchen timer does not control the cooking elements. Timer turns off if there is no activity for 30 seconds.

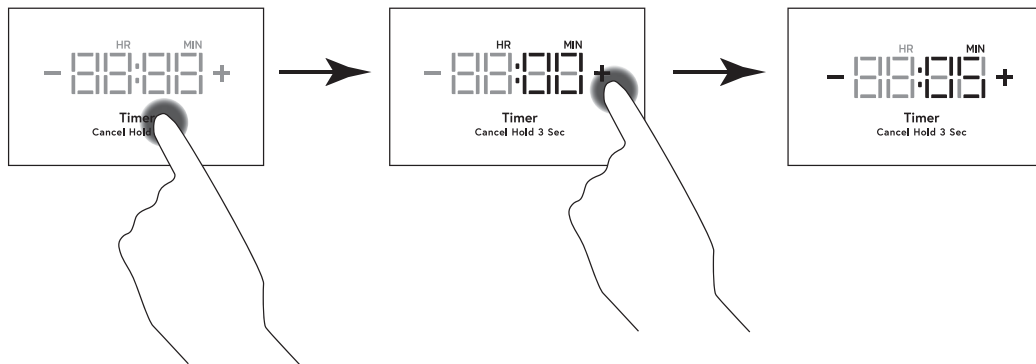

Hot Light Indicator

A hot surface indicator light (one for each cooking element) will glow when the glass surface is hot and will remain on until the surface has cooled to a temperature that is safe to touch.

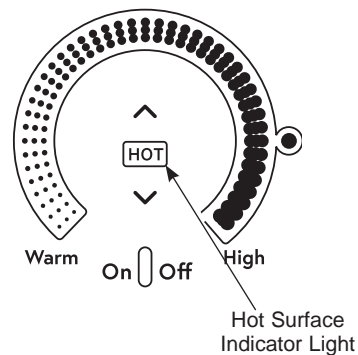

WiFi Commissioning

Download the SmartHQ App

Press the WiFi Connect pad on your cooktop to begin pairing. On the SmartHQ App, select your appliance and follow the instructions to complete the pairing.

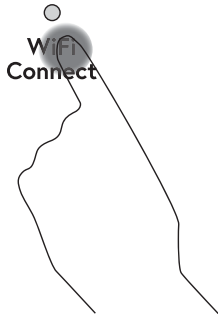

Turning Off the WiFi

Press and hold the **WiFi Connect** and the **All Off** pads for 3 seconds to de-commission the WiFi.

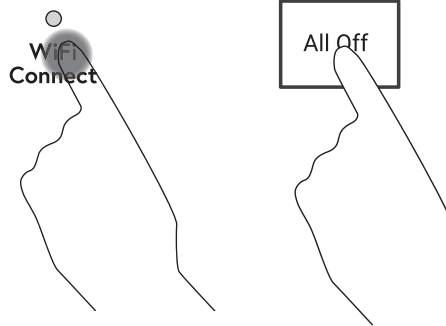

Bluetooth® Pairing

Pairing a Bluetooth® Device

Press the Bluetooth Connect pad on the cooktop. The cooktop will enter Pair mode. Tap cookware or press ChefConnect button on enabled microwave or hood device. When connected, the cooktop will display "donE".

Supported Devices	How to Initiate Pairing
Hestan Cue fry pan	Tap pan handle twice
Hestan Cue pot	Tap pot handle twice

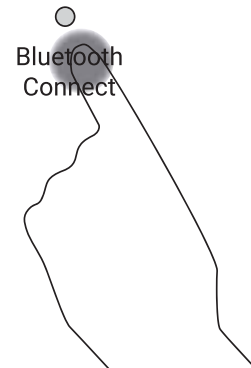

Removing Bluetooth® Devices

Tap and hold the **Bluetooth Connect** and **All Off** pads for 3 seconds.

NOTE: Your unit cannot delete a single or specific device. All of your paired devices are cleared. Devices you wish to use must be paired again.

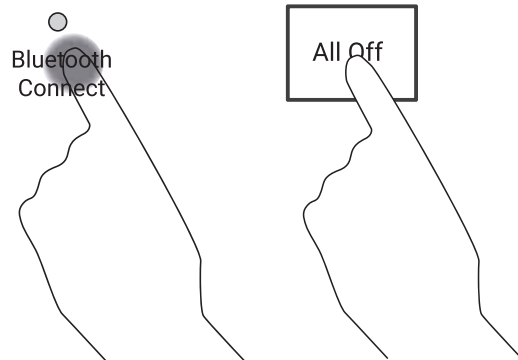

Precision Cooking

The Precision Cooking feature allows precise temperature control of certain devices for improved results

Initiating a Precision Cooking Mode

1. Press the **Power On/Off** pad on the desired element.
2. Tap **Precision Cooking** pad.
5. Cooktop will display target temperature and Preheating. When Preheating legend disappears, target temperature has been reached.

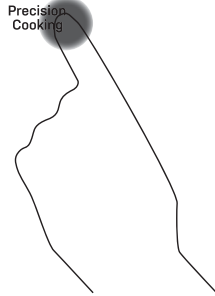

3. **TAP COOKWARE** legend will pulse. Activate cookware and ensure cookware is on desired element.



4. Precision Cooking Degrees legend will turn on. Use slider or **Λ** and **V** pads to adjust temperature.

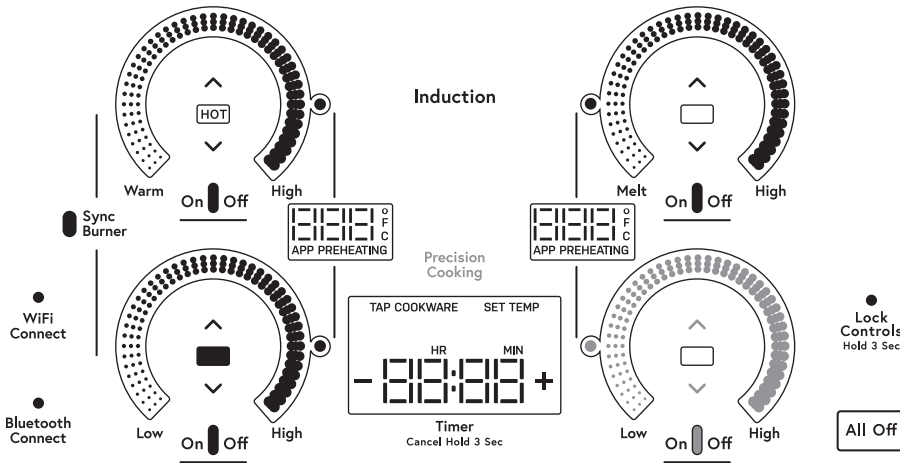

Settings Menu

1. Press and hold **All Off** and **Timer** pads together for 3 seconds.

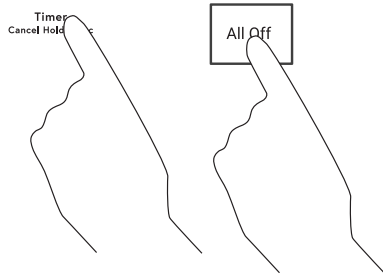

3. To activate a Setting, press the **Timer** pad.
4. To exit Settings Menu, press and hold the **All Off** pad.

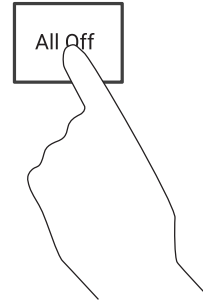

2. To navigate through the Settings Menu, use the **▲** and **▼** buttons on the Display. To select a menu, press the **Timer** pad.



Settings Menu Chart

	Feature	Menu	Default	Options	Requirements
1	Factory Settings	FACT rst	No	YES	<ul style="list-style-type: none"> "YES" : Clears customized settings and restores defaults "No" : exits out of the Factory reset menu and takes the user back to the main menu.
2	Control Lock	Loc	USER	Auto	<ul style="list-style-type: none"> "USER" : Control lock shall have as defined in Cooktop Control Lockout "Auto" : In addition to the standard lock behavior (Cooktop Control Lockout) the control shall also lock if no burner or timer has been active for 600 seconds as well as there has been no key press for 600 seconds.
3	LED Light Level	LED	Hi	reg Lo	<ul style="list-style-type: none"> Hi = 100% brightness rEG = 80% brightness Lo = 60% brightness
4	Button Volume	touch Snd	Hi	Lo OFF	<ul style="list-style-type: none"> "Hi" : All touch key sounds activated at 100% "Lo" : Touch key sound levels as defined in parametric (ideally 50% of high). "OFF" : All touch key sounds off. The sound settings shall not affect alarm tone output levels.
5	Timer Alarm Volume	tone Snd	Hi	Lo	<ul style="list-style-type: none"> "Hi" : The DAC level shall be defined in parametric. The product level expectation is to achieve 40dB @ 5 meters from cooktop. 65dB @ 1 meter from cooktop. "Lo" : The DAC level shall be defined in parametric. The product level expectation is to achieve 40dB @ 1 meter from cooktop.
6	Timer End Tone	End tone	Cont	BEEP	<ul style="list-style-type: none"> "Cont" : Timer tone plays continuously until the user acknowledges the timer and tone. "bEEP" : The timer end tone is played only once.
7	Temperature Units	deg Unit	F	C	

Griddle (optional accessory)

Using the Griddle

CAUTION Burn Hazard

- Griddle surfaces may be hot enough to cause burns during and after use. Place and remove the griddle when it is cool and all surface units are off. Use oven mitts if you will touch the griddle while hot. Failure to do so can result in burns.
- Place and remove the griddle only when griddle is cool and all surface burners are turned Off.

Before using this cookware for the first time, wash it to make sure it is clean. Then season it lightly, rubbing cooking oil onto the cooking surface.

How To Place The Griddle

IMPORTANT: Always place and use your griddle at the designated location on the cooktop.

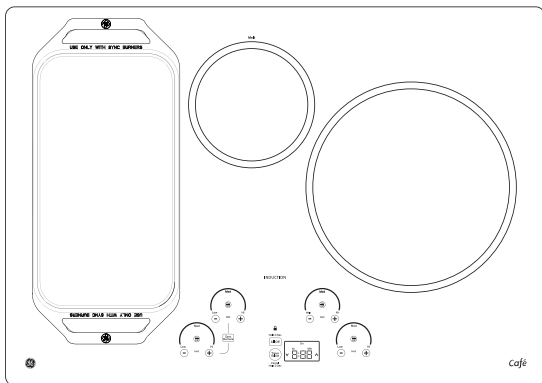

IMPORTANT NOTES:

- Clean the griddle with a sponge and mild detergent in warm water. DO NOT use blue or green scrubbing pads or steel wool.
- Avoid cooking extremely greasy foods and be careful of grease spillover while cooking.
- Never place or store any items on the griddle, even when it is not in use. The griddle can become heated when using the surrounding surface units.
- Avoid using metal utensils with sharp points or rough edges, which might damage the griddle. Do not cut foods on the griddle.
- Do not use cookware as a storage container for food or oil. Permanent staining and/or craze lines could result.
- Your griddle will discolor over time with use.
- Do not clean the griddle in a self-cleaning oven.
- Always allow the cookware to cool before immersing in water.
- Do not overheat the griddle.

Type of Food	Cook Setting
Warming Tortillas	Med-Lo
Pancakes	Med-Lo
Hamburgers	Med
Fried Eggs	Med-Lo
Breakfast Sausage Links	Med
Hot Sandwiches (such as Grilled Cheese)	Med-Lo

Griddle settings are intended to be a guideline and may need to be adjusted based on individual cooking preferences.

Griddle Operation

To turn on the surface units for the entire griddle, use the Sync Burner control feature. Touch the **Sync Burner** pad and then adjust power level to desired setting as described on page 9.

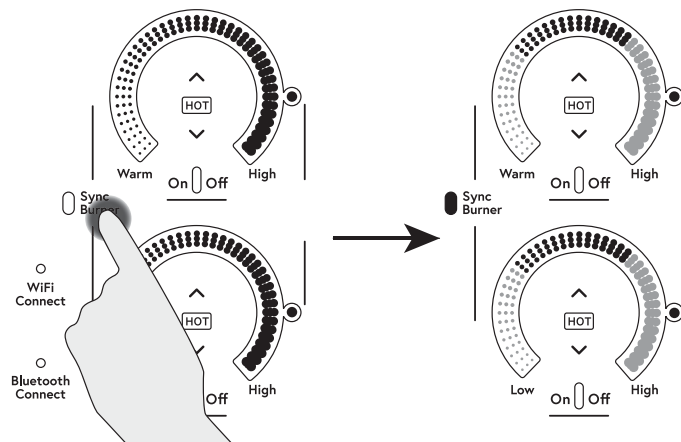

Cleaning the Glass Cooktop

To maintain and protect the surface of your glass cooktop, follow these steps:

1. Before using the cooktop for the first time, clean it with a ceramic cooktop cleaner. This helps protect the top and makes cleanup easier.
2. Regular use of a ceramic cooktop cleaner will help keep the cooktop looking new.
3. Shake the cleaning cream well. Apply a few drops of a ceramic cooktop cleaner directly to the cooktop.
4. Use a paper towel or a non-scratch cleaning pad for ceramic cooktops to clean the entire cooktop surface.
5. Use a dry cloth or paper towel to remove all cleaning residue. No need to rinse.

NOTE: It is very important that you DO NOT heat the cooktop until it has been cleaned thoroughly.

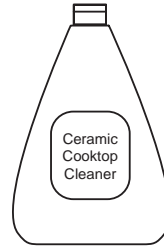

Clean your cooktop after each spill. Use a ceramic cooktop cleaner.



For cleaning videos and instructions, scan the QR code with your device.

Burned-On Residue

NOTE: DAMAGE to your glass surface may occur if you use scrub pads other than those recommended.

1. Allow the cooktop to cool.
2. Spread a few drops of a ceramic cooktop cleaner on the entire burned residue area.
3. Using a non-scratch cleaning pad for ceramic cooktops, rub the residue area, applying pressure as needed.
4. If any residue remains, repeat the steps listed above as needed.

5. For additional protection, after all residue has been removed, polish the entire surface with a ceramic cooktop cleaner and a paper towel.

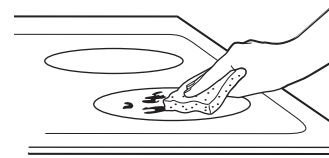

Use a non-scratch cleaning pad for ceramic cooktops.

Heavy, Burned-On Residue

1. Allow the cooktop to cool.
2. Use a single-edge razor blade scraper at approximately a 45° angle against the glass surface and scrape the soil. It will be necessary to apply pressure to the razor scraper in order to remove the residue.
3. After scraping with the razor scraper, spread a few drops of a ceramic cooktop cleaner on the entire burned residue area. Use a non-scratch cleaning pad to remove any remaining residue.
4. For additional protection, after all residue has been removed, polish the entire surface with a ceramic cooktop cleaner and a paper towel.

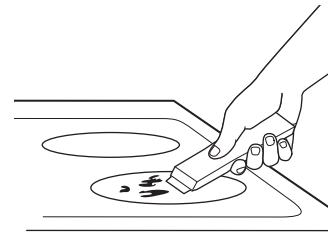

The ceramic cooktop scraper and all recommended supplies are available through our Parts Center. See instructions under "Assistance / Accessories" section.

NOTE: Do not use a dull or nicked blade.

Cleaning the Glass Cooktop (Cont.)

Metal Marks and Scratches

1. Be careful not to slide pots and pans across your cooktop. It will leave metal markings on the cooktop surface.

These marks are removable using a ceramic cooktop cleaner with a non-scratch cleaning pad for ceramic cooktops.

2. If pots with a thin overlay of aluminum or copper are allowed to boil dry, the overlay may leave black discoloration on the cooktop.

This should be removed immediately before heating again or the discoloration may be permanent.

NOTE: Carefully check the bottom of pans for roughness that would scratch the cooktop.

3. Be careful not to place aluminum baking sheets or aluminum frozen entrée containers on a hot cooktop surface. It will leave shiny dots or markings on the cooktop surface. These markings are permanent and cannot be cleaned off.

Damage from Sugary Spills and Melted Plastic

Special care should be taken when removing hot substances **to avoid permanent damage of the glass surface**. Sugary spillovers (such as jellies, fudge, candy, syrups) or melted plastics can cause pitting of the surface of your cooktop (not covered by the warranty) unless the spill is removed while still hot. Special care should be taken when removing hot substances.

Be sure to use a new, sharp razor scraper.

Do not use a dull or nicked blade.

1. Turn off all surface units. Remove hot pans.
2. Wearing an oven mitt:

- a. Use a single-edge razor blade scraper to move the spill to a cool area on the cooktop.
- b. Remove the spill with paper towels.

3. Any remaining spillover should be left until the surface of the cooktop has cooled.

4. Don't use the surface units again until all of the residue has been completely removed.

NOTE: If pitting or indentation in the glass surface has already occurred, the cooktop glass will have to be replaced. In this case, service will be necessary.

Troubleshooting Tips ... Before you schedule service

Save time and money! Review the charts on the following pages first and you may not need to schedule service. If an error occurs in the control operation, a fault code will flash in the display. Record the error code and schedule service. Check out self-help videos and FAQ at cafeappliances.com/support.

Problem	Possible Cause	What To Do
Surface elements will not maintain a rolling boil or cooking is slow	Improper cookware being used.	Use pans that are absolutely flat and match the diameter of the surface unit selected.
Surface elements do not work properly	Cooktop controls improperly set.	Check to be sure the correct control is set for the surface element you are using.
Power arc ON indicator blinking	Λ, V or control lock pads have been touched before an element is turned on.	See the Operating the Cooking Elements section.
Scratches on cooktop glass surface	Incorrect cleaning methods being used.	Use recommended cleaning procedures. See the Cleaning the glass cooktop section.
	Cookware with rough bottoms being used or coarse particles (salt or sand) were between the cookware and the surface of the cooktop. Cookware has been slid across the cooktop surface.	To avoid scratches, use the recommended cleaning procedures. Make sure bottoms of cookware are clean before use, and use cookware with smooth bottoms.

Troubleshooting Tips ... Before you schedule service

Problem	Possible Cause	What To Do
Areas of discoloration on the cooktop	Food spillovers not cleaned before next use.	See the Cleaning the glass cooktop section.
	Hot surface on a model with a light-colored glass cooktop.	This is normal. The surface may appear discolored when it is hot. This is temporary and will disappear as the glass cools.
Plastic melted to the surface	Hot cooktop came into contact with plastic placed on the hot cooktop.	See the Glass surface – potential for permanent damage section in the Cleaning the glass cooktop section.
Pitting (or indentation) of the cooktop	Hot sugar mixture spilled on the cooktop.	Call a qualified technician for replacement.
Unresponsive keypad	Keypad is dirty.	Clean the keypad.
	A fuse in your home may be blown or the circuit breaker tripped.	Replace the fuse or reset the circuit breaker.
	Object, such as utensil or debris, is on the control interface.	Remove object from control interface.
	Liquid is on the control interface.	Wipe control interface to remove liquid.
Precision Cooking button beeps error tone when pressed one time	There is no precision cooking device paired, so you are unable to start a precision cooking mode.	Connect a precision cooking device.
Pan won't pair or activate when tapping handle	Tapping force is too light.	Double tap the pan with firm taps (or knock) on the black plastic endcap.
	Battery in pan is low or dead.	Replace AAA battery, installing with positive end out of handle.
	Using different pan hardware.	Check that your pan has a black endcap that unscrews from the end of the handle. Pans with an oval module reading "Hestan Cue®" will not work with Café appliances.
Experiencing performance or minor technical issues including seeing 20F or 100F as set temperature	Old unit or pan software.	Connect your unit to the SmarthQ app and update unit software. Connect your unit and pan to the Hestan Smart Cooking app and update pan software.
The unit cancelled my precision cooking mode	Battery in device is low or dead.	Replace AAA battery in pan, or charge probe.
	Old unit or pan software.	Connect your unit to the SmarthQ app and update unit software. Connect your unit and pan to the Hestan Smart Cooking app and update pan software.
	Your precision cooking device has gone out of range.	This could indicate a problem with the device. If the problem persists, please contact the device manufacturer.
	Your precision cooking device had a computation malfunction.	
	The unit lost communication with your precision cooking device.	This could indicate a problem with the device or the unit. If the problem persists, please contact the device or unit manufacturer.
	Some cooking techniques and set temperatures in combination may trigger a fault in the temperature sensing algorithm.	Re-start the precision cooking mode and if problem persists under the same conditions but is not consistent in other use cases, contact the unit manufacturer.
Unable to reach set temperature in Precision Cooking Mode	Boiling water or cooking liquid based foods at high temperatures will result in temperature stalls close to the set temperature.	Use temperature settings for pan frying, sautéing, and searing when using Hestan Cue cookware or built-in conventional Precision Cooktop Sensor. The Precision Cooking Probe accessory can be used to control liquid temperatures between 100-200° F for slow cooking, simmering, and advanced cooking techniques like Sous Vide.

CAFÉ Electric Cooktop Limited Warranty

cafeappliances.com

All warranty service is provided by our Factory Service Centers, or an authorized service technician. To schedule service online, visit us at cafeappliances.com/service. Please have your serial number and your model number available when scheduling service.

Servicing your appliance may require the use of the onboard data port for diagnostics. This gives a CAFÉ factory service technician the ability to quickly diagnose any issues with your appliance and helps CAFÉ improve its products by providing CAFÉ with information on your appliance. If you do not want your appliance data to be sent to CAFÉ, please advise your technician not to submit the data to CAFÉ at the time of service.

For the period of	CAFÉ will replace
One year From the date of the original purchase	Any part of the cooktop which fails due to a defect in materials or workmanship. During this limited one-year warranty , CAFÉ will provide, free of charge , all labor and in-home service to replace the defective part.

What CAFÉ will not cover:

- Service trips to your home to teach you how to use the product.
- Improper installation, delivery or maintenance.
- Failure of the product if it is abused, misused, modified or used for other than the intended purpose or used commercially.
- Damage to the glass cooktop caused by use of cleaners other than the recommended cleaning creams and pads.
- Damage to the glass cooktop caused by hardened spills of sugary materials or melted plastic that are not cleaned according to the directions in the Owner's Manual.
- Replacement of house fuses or resetting of circuit breakers.
- Damage to the product caused by accident, fire, floods or acts of God.
- Incidental or consequential damage caused by possible defects with this appliance.
- Damage caused after delivery.
- Product not accessible to provide required service.
- Service to repair or replace light bulbs, except for LED lamps.
- Effective January 1, 2022, cosmetic damage to the glass cooktop such as, but not limited to, chips, scratches, or baked on residue not reported within 90 days of installation.
- Effective January 1, 2022, damage to the glass cooktop due to impact or misuse. See example.



Staple your receipt here. Proof of the original purchase date is needed to obtain service under the warranty.

EXCLUSION OF IMPLIED WARRANTIES

Your sole and exclusive remedy is product repair as provided in this Limited Warranty. Any implied warranties, including the implied warranties of merchantability or fitness for a particular purpose, are limited to one year or the shortest period allowed by law.

This limited warranty is extended to the original purchaser and any succeeding owner for products purchased for home use within the USA. If the product is located in an area where service by a CAFÉ Authorized Servicer is not available, you may be responsible for a trip charge or you may be required to bring the product to an Authorized CAFÉ Service location for service. In Alaska, the limited warranty excludes the cost of shipping or service calls to your home. Some states do not allow the exclusion or limitation of incidental or consequential damages. This limited warranty gives you specific legal rights, and you may also have other rights which vary from state to state. To know what your legal rights are, consult your local or state consumer affairs office or your state's Attorney General.

Warrantor: GE Appliances, a Haier company

Louisville, KY 40225

Extended Warranties: Purchase a CAFÉ extended warranty and learn about special discounts that are available while your warranty is still in effect. You can purchase it online anytime at

cafeappliances.com/extended-warranty

CAFÉ Service will still be there after your warranty expires.

Accessories

Looking For Something More?

CAFÉ offers a variety of accessories to improve your cooking and maintenance experiences!

Refer to the Consumer Support page for website information.

The following products and more are available:

Parts

Griddle

Stainless Steel Cleaner and Polisher

Consumer Support

CAFÉ Website

Have a question or need assistance with your appliance? Try the CAFÉ website 24 hours a day, any day of the year! You can also shop for more great CAFÉ products and take advantage of all our on-line support services designed for your convenience. In the US: cafeappliances.com In Canada: cafeappliances.ca

Register Your Appliance

Register your new appliance on-line at your convenience! Timely product registration will allow for enhanced communication and prompt service under the terms of your warranty, should the need arise. You may also mail in the pre-printed registration card included in the packing material. In the US: cafeappliances.com/register
In Canada: cafeappliances.ca/support/contact-us

Schedule Service

Expert CAFÉ repair service is only one step away from your door. Get on-line and schedule your service at your convenience any day of the year. In the US: cafeappliances.com/service
In Canada: cafeappliances.ca/support/contact-us

Extended Warranties

Purchase a CAFÉ extended warranty and learn about special discounts that are available while your warranty is still in effect. You can purchase it on-line anytime. CAFÉ Service will still be there after your warranty expires. In the US: cafeappliances.com/extended-warranty

Remote Connectivity

For assistance with wireless network connectivity (for models with remote enable), visit our website at cafeappliances.com/connect

Parts and Accessories

Individuals qualified to service their own appliances can have parts or accessories sent directly to their homes (VISA, MasterCard and Discover cards are accepted). Order on-line today 24 hours every day. In the US: cafeappliances.com/parts

Instructions contained in this manual cover procedures to be performed by any user. Other servicing generally should be referred to qualified service personnel. Caution must be exercised, since improper servicing may cause unsafe operation.

Customers in Canada should consult the yellow pages for the nearest Mabe service center, visit our website at service.geappliances.ca/servicio

Contact Us

If you are not satisfied with the service you receive from CAFÉ, contact us on our website with all the details including your phone number, or write to:

In the US: General Manager, Customer Relations | CAFÉ Appliances, Appliance Park | Louisville, KY 40225
cafeappliances.com/contact

In Canada: Director, Consumer Relations, Mabe Canada Inc. | Suite 310, 1 Factory Lane | Moncton, N.B. E1C 9M3
cafeappliances.ca/support/contact-us