

CPF48UGMX

Range size	48"
Main oven	Thermo-ventilated
Secondary oven	Static
EAN code	8017709259082



Aesthetic













Aesthetics	Portofino	Control setting type	Control knobs
Design	Flush mounted	No. of controls	10
Color	Stainless steel	Silkscreen color	Black
Finishing	Satin	Display	Touch
Logo	Stainless steel	Handle	Portofino
Logo position	Fascia below the oven	Storage compartment	Storage drawer
Cooktop color	Stainless steel	Plinth	Black
Grates	Cast Iron		

Programs / Functions

No. of cooking functions 9

Traditional cooking functions

 Static	 Fan-assisted	 True European convection
 Small grill	 Large grill	 Large grill + Fan
 Bottom	 Convection bottom	 Pizza
 Rotisserie		

Other functions

 Defrost by time

Cleaning functions

 VaporClean

Secondary oven functions

Convection bottom



Cooktop technical features

Cooking zones 6

Left - 5300 W - 18000 BTU

Rear-center - 3500 W - 12000 BTU

Front-center - 1310 W - 4500 BTU

Rear-right - 3500 W - 12000 BTU

Front-right - 2340 W - 8000 BTU

Center - 1900 W - 6500 BTU

1.60 (BBQ) W - 5500 (BBQ) BTU

Gas safety valves Yes

Burner caps

Enameled matte black

Main Oven Technical Features



No. of lights 2
Fan number 3
Volume 0.16 cu. ft.
Cavity material EverClean enamel
No. of shelves 5
Shelves type Metal racks
Light type Halogen
Light Power 40 W
Time setting Start and end
Light on when door is open Yes
Removable door Yes

Total no. of door glasses 3
Safety thermostat Yes
Cooling system Tangential
Bottom heating element - Power 1700 W
Upper heating element - Power 1200 W
Grill power 1700 W
Large grill - Power 2900 W
Circular heating element - Power 1500 W
Grill type Electric
Soft Close system Yes

Main oven options

Timer Yes
End-of-cooking alarm Yes

Minimum Temperature 120 °F
Maximum temperature 500 °F

Secondary oven - Technical specifications



Fan number	1	Light on when oven door is open	Yes
Secondary oven - Volume	1.5 cu. ft.	Removable door	Yes
Cavity material	EverClean enamel	No. total door glasses	3
No. of shelves	5	Security Thermostat	Yes
Shelves type	Metal racks	Cooling system	Tangential
No. of lights	2	Lower heating element - power	750 W
Lighting	Halogen	Large grill - Power	2050 W
Light Power	40 W	Circular heating element - Power	1500 W

Secondary oven functions

Minimum Temperature	120 °F	Maximum temperature	450 °F
----------------------------	--------	----------------------------	--------

Accessories included for main oven and cooktop



Cast iron wok support	1	1.6"-deep tray	1
TOP Oven grid with back stop	2	Telescopic Guide rails, total Extraction	1

Accessories included - Secondary oven



Rack with back and side stop	1	Grill mesh	1
Wide baking tray	1	Telescopic Guide rails, total Extraction	1

Electrical Connection

Electrical connection rating	8000 W	Type of electric cable installed	Yes, Double phase
Current	50 A	Power cord length	47 1/4 "
Circuit breaker	50 A	Frequency	60 Hz
Voltage	240/208 V	Terminal block	5 poles

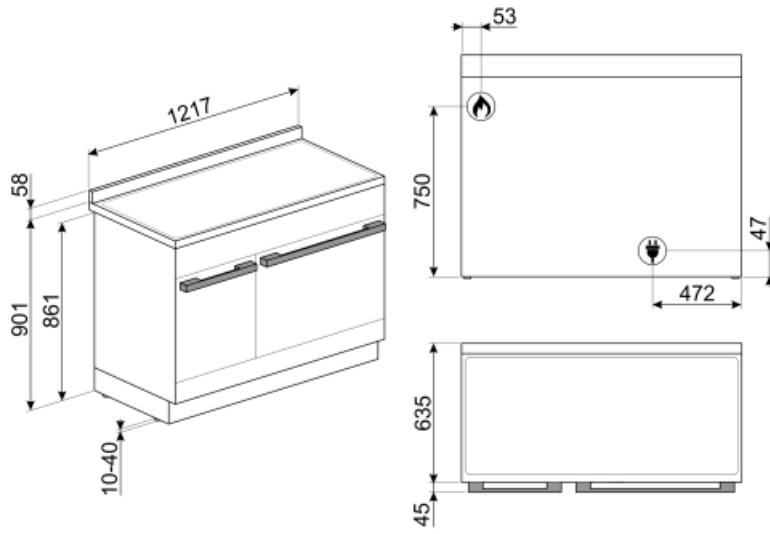

Not included accessories



SFLK1
Child lock



PPR9
Refractory pizza stone without handles. Squared stone (HxWxD): 0.9" x 25.2" x 14.75". Also suitable for gas ovens, to be placed on a rack



GTT
Total-extension telescopic guides
Length: 14" Extraction: 16.5" Material: Stainless steel AISI 430 polished



















PRTX
Refractory pizza stone with handles. D=35cm Not suitable for microwave ovens. Suitable for gas ovens, to be put on the griddle.



PALPZ
Pizza shovel with fold away handle width: 315mm length : 325mm

Symbols glossary (TT)

 <p>Triple Fan Technology: The oven is equipped with an exclusive three fan system, which, combined with the increased power of the motors, enables excellent cooking performance. The two large side fans distribute the air around the outer perimeter of the cavity while the smaller central fan increases ventilation by creating a vertical vortex of heat. Accordingly, the temperature within the cavity is uniform, allowing food to be cooked evenly on all five levels, like in professional kitchens.</p>	 <p>Heavy duty cast iron pan stands: for maximum stability and strength.</p>
 <p>Installation in column: Installation in column</p>	 <p>Knobs control</p>
 <p>Air cooling system: to ensure a safe surface temperatures.</p>	 <p>Defrost by time: with this function the time of thawing of foods are determined automatically.</p>
 <p>...</p>	 <p>Triple glazed doors: Number of glazed doors.</p>
 <p>Enamel interior: The enamel interior of all Smeg ovens have a special antacid lining which helps keep the interior clean by reducing the amount of cooking grease adhering to it.</p>	 <p>Circogas: In gas ovens the fan distributes the heat quickly and evenly throughout the oven cavity, avoiding flavour transfer when cooking a number of different dishes at the same time. In electric ovens this combination completes cooking more quickly of foods that are ready on the surface, but that require more cooking inside, without further browning.</p>
 <p>Fan with upper and lower elements: The elements combined with the fan aim to provide more uniform heat, a similar method to conventional cooking, so pre-heat is required. Most suitable for items requiring slow cooking methods.</p>	 <p>Upper and lower element only: a traditional cooking method best suited for single items located in the centre of the oven. the top pf the oven will always be hottest. Ideal for roast, fruit cakes, bread etc.</p>
 <p>Lower heating element only: This function is ideal for foods that require extra base temperature without browning, e.g. pastry dishes, pizza. Also suitable for slow cooking of stews and casseroles.</p>	 <p>True European Convection: The combination of the fan and circular heating element around it provides many benefits, including no preheat if cooking time is longer than 20 minutes, no flavor transfer when cooking different foods at the same time, lower energy consumption, and shorter cooking times. Suitable for all types of food preparations.</p>
 <p>Grill element: Using of grill gives excellent results when cooking meat of medium and small portions, especially when combined with a rotisserie (where possible). Also ideal for cooking sausages and bacon.</p>	 <p>Half grill: For rapid cooking and browning of foods. Best results can be obtained by using the top shelf for small items, the lower shelves for larger ones, such as chops or sausages. For half grill heat is generated only at the centre of the element, so is ideal for smaller quantities.</p>



Fan with grill element: The fan reduces the fierce heat from the grill, providing an excellent method of grilling various foods, chops, steaks, sausages etc. giving even browning and heat distribution, without drying out the food. The top two levels recommended for use, and the lower part of the oven can be used to keep items warm at the same time, an excellent facility when cooking a grilled breakfast. Half grill (centre portion only) is ideal for small quantities of food.



Pizza function: The simultaneous operation of three elements ensures an optimum cooking facility when used with the Smeg pizza stone.



Rotisserie: The rotisserie (where installed) works in combination with the grill element to brown foods to perfection.



Side lights: Two opposing side lights increase visibility inside the oven.



The oven cavity has 5 different cooking levels.



Soft close: all models are equipped with advanced function of smooth closing of the door, which allows the device to close smoothly and quietly.



Telescopic rails: allow you to pull out the dish and check it without having to remove it from the oven entirely.



Vapor Clean: a simple cleaning function using steam to loosen deposits in the oven cavity.

Benefit (TT)

True-convection

The best cooking performances guaranteed by ventilated circular flow.

Multiple fans and heating elements guarantee the perfect aerodynamic heat flow, allowing homogeneous and quicker cooking inside the cavity.

Ever Clean Enamel

Easy oven cleaning thanks to special pyrolytic enamel

Touch control

Easy and intuitive timer setting with a single touch

Isothermic Cavity

The best cooking performance at the highest energy efficiency

Triple Turbine

The oven has three fans and two circular heating elements, allowing cooking with rotating heat

Tangential cooling

New cooling system with tangential fan and airflow from the door to the splashback

Soft close

The door is equipped with a specific system for silent closing

Multilevel halogen light

Internal halogen lighting on different levels guarantees excellent visibility

Telescopic guides

Easy extraction and safe insertion of trays into the oven thanks to telescopic guides

Adjustable height

Cooker top flushed with the working area thanks to adjustable feet

Multilevel cooking

Several cooking levels allow maximum flexibility of use

Cold door

During any function, the external door glass is cold, avoiding any risk of burns

AirFry (AIRFRY optional accessory)

Lighter and tastier food thanks to airfry basket

BBQ (optional accessory)

Barbeque cooking directly in the oven with the double-sided grill

Pizza stone (optional accessory)

Baking with refractory stone for soft and crispy pizza and yeast products (STONE optional accessory)

Storage compartment

More space thanks to the lower compartment, ideal for storing accessories or cooking utensils