



DISTINCT BY DESIGN™

Owner's Manual

Microwave Oven

Model: CVM521P

Contents

Using the Oven

Features	7
Controls	8
Time and Auto Microwave Features	10
Power Level	12
Sensor Microwave Features	13
Other Features	17
Microwave Terms	20

Exhaust Feature	23
Troubleshooting	24
Limited Warranty	26
Optional Accessories	27
Consumer Support	28

Care and Cleaning

Inside	21
Outside	21
Replacing the Light Bulb	22

Write the model and serial numbers here:

Model # _____

Serial # _____

You'll find them on a label when the door is open.

Español

Para consultar una version en español de este manual de instrucciones, visite nuestro sitio de internet cafeappliances.com.

THANK YOU FOR MAKING CAFÉ A PART OF YOUR HOME.

We take pride in the craftsmanship, innovation and design that goes into every Café product, and we think you will too. Among other things, registration of your appliance ensures that we can deliver important product information and warranty details when you need them.

Register your Café appliance now online. Helpful websites are available in the Consumer Support section of this Owner's Manual. You may also mail in the pre-printed registration card included in the packing material.

C A F É

DISTINCT BY DESIGN™

IMPORTANT SAFETY INFORMATION

READ ALL INSTRUCTIONS BEFORE USING THE APPLIANCE

▲ WARNING

To reduce the risk of burns, electric shock, fire, injury to persons, or exposure to excessive microwave energy:

When using electrical appliances, basic safety precautions should be followed, including the following:

- Read all instructions before using this appliance.
- Read and follow the specific precautions in the PRECAUTIONS TO AVOID POSSIBLE EXPOSURE TO EXCESSIVE MICROWAVE ENERGY section on page 6.
- Use this appliance only for its intended use as described in this manual. Do not use corrosive chemicals or vapors in this appliance. This oven is specifically designed to heat, dry or cook food, and is not intended for laboratory or industrial use.
- This microwave must only be serviced by qualified service personnel. Contact nearest authorized service facility for examination, repair or adjustment.

INSTALLATION

- Install or locate this appliance only in accordance with the provided installation instructions.
- This appliance must be grounded. Connect only to properly grounded outlet. See "GROUNDING INSTRUCTIONS" found on page 5.
- This microwave oven is ETL listed for installation over both gas and electric ranges.
- This unit is suitable for use above gas or electric cooking equipment, 36" or less wide.
- Do not operate this appliance if it has a damaged power cord or plug, if it is not working properly, or if it has been damaged or dropped.
- Keep cord away from heated surfaces.
- Do not let cord hang over the edge of the table or counter
- Do not immerse cord or plug in water.
- Do not cover or block any openings on the appliance.
- Do not store this appliance outdoors. Do not use this product near water—for example, in a wet basement, near a swimming pool, near a sink or in similar locations.
- Do not mount this appliance over a sink.

TO REDUCE THE RISK OF FIRE IN THE CAVITY:

- Do not overcook food. Carefully attend appliance when paper, plastic or other combustible materials are placed inside the oven to facilitate cooking.
- Remove wire twist-ties and metal handles from paper or plastic containers before placing them in the oven.
- Do not store any materials, other than our recommended accessories, in this oven when not in use. Do not leave paper products, cooking utensils or food in the cavity when not in use. Microwave rack should be removed from oven when not in use.
- If materials inside the oven ignite, keep the oven door closed, turn the oven off and disconnect the power cord or shut off power at the fuse or circuit breaker panel.
- Do not operate the microwave feature without food in the oven.

TO REDUCE THE RISK OF BURNS:

- Be careful when opening containers of hot food. Use pot holders and direct steam away from face and hands.
- Vent, pierce, or slit containers, pouches, or plastic bags to prevent build-up of pressure.
- Be careful when touching the turntable, door, racks, or walls of the oven which may become hot during use.
- **HOT CONTENTS CAN CAUSE SEVERE BURNS. DO NOT ALLOW CHILDREN TO USE THE MICROWAVE.** Use caution when removing hot items.

READ AND SAVE THESE INSTRUCTIONS

IMPORTANT SAFETY INFORMATION

READ ALL INSTRUCTIONS BEFORE USING THE APPLIANCE

▲ WARNING Continued

OPERATING AND CLEANING

- Do not store anything directly on top of the microwave oven surface when the microwave oven is in operation.
- Oversized foods or oversized metal utensils should not be inserted in a microwave/convection oven as they may create a fire or risk of electric shock.
- Do not clean with metal scouring pads. Pieces can burn off the pad and touch electrical parts involving a risk of electric shock.
- Do not use paper products in oven when appliance is operating in any cooking mode except microwave.
- Some products such as whole eggs and sealed containers—for example, closed jars—are able to explode and should not be heated in this microwave oven.
- Do not cover any part of the microwave with metal foil. This will cause overheating of the microwave oven.
- Cook meat and poultry thoroughly—meat to at least an INTERNAL temperature of 160°F, and poultry to at least an INTERNAL temperature of 180°F. Cooking to these temperatures usually protects against foodborne illness.
- Make sure all cookware used in your microwave oven is suitable for microwaving. Most glass casseroles, cooking dishes, measuring cups, custard cups, pottery or china dinnerware which does not have metallic trim or glaze with a metallic sheen can be used in compliance with cookware manufacturers' recommendations.

- It is important to keep the area clean where the door seals against the microwave. Use only mild, nonabrasive detergents applied with a clean sponge or soft cloth. Rinse well.

SUPER HEATED WATER

- Liquids, such as water, coffee, or tea, are able to be overheated beyond the boiling point without appearing to be boiling. Visible bubbling or boiling when the container is removed from the microwave oven is not always present. **THIS COULD RESULT IN VERY HOT LIQUIDS SUDDENLY BOILING OVER WHEN THE CONTAINER IS DISTURBED OR A SPOON OR OTHER UTENSIL IS INSERTED INTO THE LIQUID.**
- To reduce the risk of injury to persons:
 - Do not overheat the liquid.
 - Stir the liquid both before and halfway through heating it.
 - Do not use straight-sided containers with narrow necks.
 - After heating, allow the container to stand in the microwave oven for a short time before removing the container.
 - Use extreme care when inserting a spoon or other utensil into the container.

READ AND SAVE THESE INSTRUCTIONS

IMPORTANT SAFETY INFORMATION

READ ALL INSTRUCTIONS BEFORE USING THE APPLIANCE

GROUNDING INSTRUCTIONS

▲WARNING To prevent risk of electric shock, follow these instructions:

- Plug microwave into a grounded 3-prong outlet.
- Do not remove the ground prong or use an adapter.
- Do not use an extension cord.

Improper use of the grounding plug can result in a risk of electric shock.

This appliance must be grounded. In the event of an electrical short circuit, grounding reduces the risk of electric shock by providing an escape wire for the electric current.

This appliance is equipped with a power cord having a grounding wire with a grounding plug. The plug must be plugged into an outlet that is properly installed and grounded.

Consult a qualified electrician or service technician if the grounding instructions are not completely understood, or if doubt exists as to whether the appliance is properly grounded.

A short power-supply is provided to reduce the risks resulting from becoming entangled or tripping over a longer cord. Do not use an extension cord with this appliance. If the power cord is too short, have a qualified electrician or service technician install an outlet near the appliance.

VENT FAN

The fan will operate automatically under certain conditions. Take care to prevent the starting and spreading of accidental cooking fires while the vent fan is in use.

- Clean the underside of the microwave often. Do not allow grease to build up on the microwave or the fan filters.
- In the event of a grease fire on the surface units below the microwave oven, smother a flaming pan on the surface unit by covering the pan completely with a lid, a cookie sheet or a flat tray.

- Use care when cleaning the vent fan filters. Corrosive cleaning agents, such as lye-based oven cleaners, may damage the filters.
- When preparing flaming foods under the microwave, turn the fan on.
- Never leave surface units beneath your microwave oven unattended at high heat settings. Boilovers cause smoking and greasy spillovers that may ignite and spread if the microwave vent fan is operating. To minimize automatic fan operation, use adequate sized cookware and use high heat on surface units only when necessary.

PACEMAKERS

Most pacemakers are shielded from interference from electronic products, including microwaves. However, patients with pacemakers may wish to consult their physicians if they have concerns.

READ AND SAVE THESE INSTRUCTIONS

IMPORTANT SAFETY INFORMATION

READ ALL INSTRUCTIONS BEFORE USING THE APPLIANCE

PRECAUTIONS TO AVOID POSSIBLE EXPOSURE TO EXCESSIVE MICROWAVE ENERGY

- (a) **Do Not Attempt** to operate this oven with the door open since open-door operation can result in harmful exposure to microwave energy. It is important not to defeat or tamper with the safety interlocks.
- (b) **Do Not Place** any object between the oven front face and the door or allow soil or cleaner residue to accumulate on sealing surfaces.
- (c) **Do Not Operate** the oven if it is damaged. It is particularly important that the oven door close properly and that there is no damage to the:
 - (1) door (bent),
 - (2) hinges and latches (broken or loosened),
 - (3) door seals and sealing surfaces.
- (d) **The Oven Should Not** be adjusted or repaired by anyone except properly qualified service personnel. Contact nearest authorized service facility for examination, repair or adjustment.

READ AND SAVE THESE INSTRUCTIONS

Features

Throughout this manual, features and appearance may vary from your model.

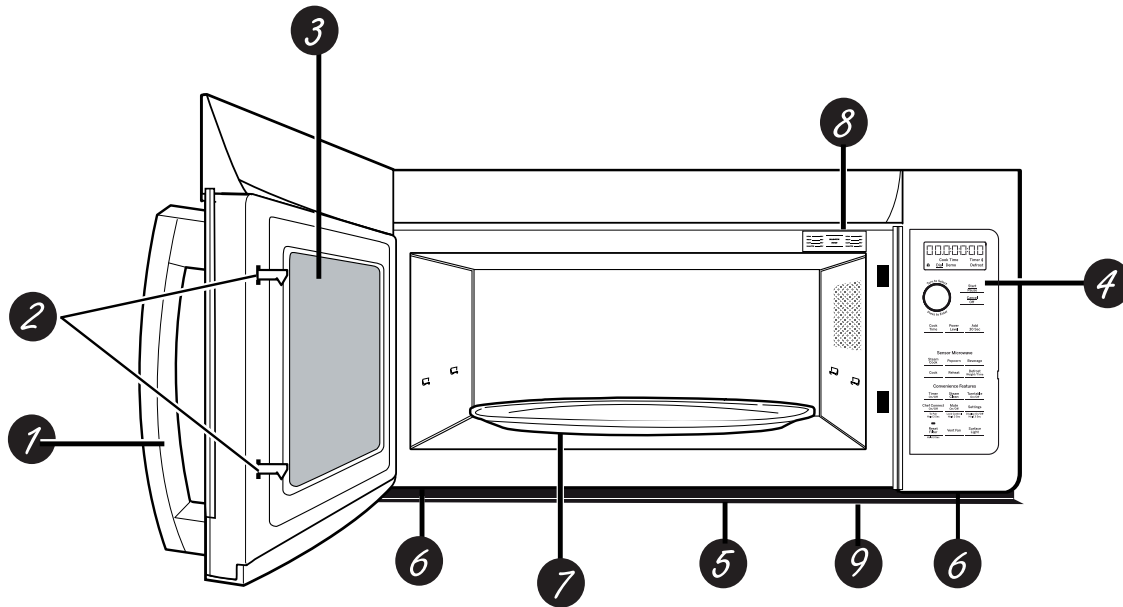

- 1 **Door Handle.** Pull to open the door. The door must be securely latched for the microwave to operate.
- 2 **Door Latches.**
- 3 **Window with Metal Shield.** Screen allows cooking to be viewed while keeping microwaves confined in the oven.
- 4 **Control Panel and Selector Dial.**
- 5 **Cooktop Light.**
- 6 **Grease Filter.**
- 7 **Removable Turntable.** Turntable and support **must**

be in place when using the oven. The turntable may be removed for cleaning.

- 8 **Rating Plate.**
- 9 **Deflector.** Provides robustness from cooktop heat. Do not remove.

NOTE: Oven vent(s) and oven light are located on the inside walls of the microwave oven.

Controls

Microwave Cooking Time and Auto Features

Press	Turn and push dial to enter
Cook Time Press once (Cook Time I) to microwave any time between 15 seconds and 99 minutes. Press twice (Cook Time II) to add a 2nd microwave cooking stage.	Amount of cooking time
Power Level	Power level 1–10
Add 30 sec.	Starts immediately!
Defrost Weight/Time Press once (Weight Defrost) Press twice (Timed Defrost)	Food weight up to six pounds Amount of defrosting time

Sensor Features

Press	Turn and push dial to enter	Option
Steam Cook/Food Type	Food Type	
Popcorn	Starts immediately!	
Beverage	Starts immediately!	
Cook	Food Type	
Reheat	Food Type	

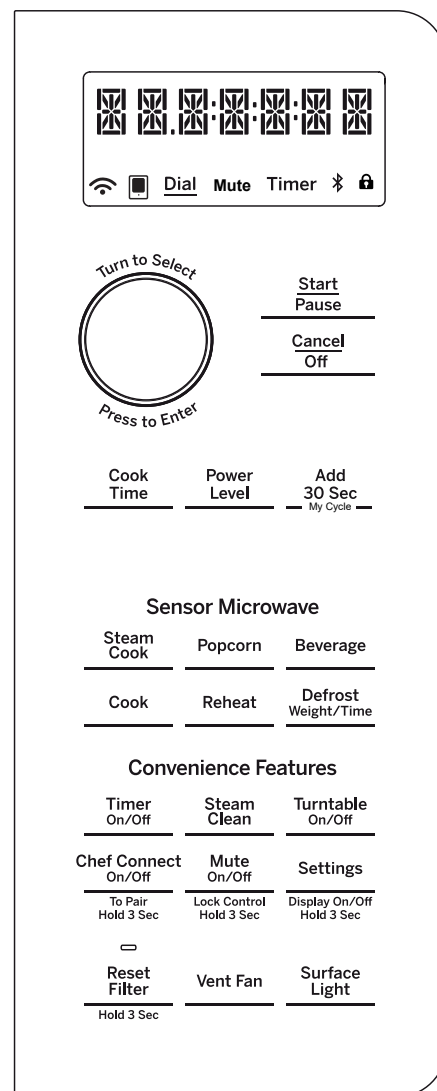

Time and Auto Microwave Features

Using the Dial

You can make selections on the oven by turning the dial and pressing it to enter the selection.

Pressing the dial can also be used in place of the **Start/Pause** button for quicker programming of the oven.

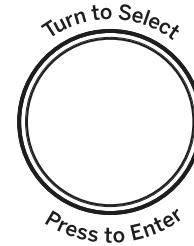

Cook Time

(Do not use the shelves when microwave cooking.)

Cook Time

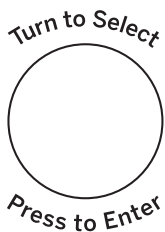

Power Level

Start/Pause

Cook Time I

Allows you to microwave for any time between 15 seconds and 99 minutes.

Power level 10 (High) is automatically set, but you may change it for more flexibility.

1. Press the **Cook Time** button.
2. Turn the dial to set the cook time and press the dial to enter.
3. Change power level if you don't want full power. (Press **Power Level**. Turn the dial to select. Press the dial to enter.)
4. Press the dial or the **Start/Pause** button to start cooking.

You may open the door during **Cook Time** to check the food. Close the door and press the dial or **Start/Pause** to resume cooking.

NOTE: You may change the cook time at any time during cooking by turning the dial. You may also change the power level by pressing the **Power Level** button.

Cook Time II

Lets you change power levels automatically during cooking. Here's how to do it:

1. Press the **Cook Time** button.
2. Turn the dial to set the first cook time and press the dial to enter.
3. Change the power level if you don't want full power. (Press **Power Level**. Turn the dial to select. Press the dial to enter.)
4. Press the **Cook Time** button again.
5. Turn the dial to set the second cook time and press the dial to enter.
6. Change the power level if you don't want full power. (Press **Power Level**. Turn the dial to select. Press the dial to enter.)
7. Press the dial or the **Start/Pause** button to start cooking.

At the end of **Cook Time I**, **Cook Time II** counts down.

NOTE: You may change the cook time at any time during cooking by turning the dial. You may also change the power level by pressing the **Power Level** button.

Add 30 Sec

This is a quick way to set and start cooking in 30 second blocks each time the **Add 30 Second** button is pressed. The cook time may be changed by turning the dial at any time during cooking.

The power level will automatically be set at 10 and the oven will start immediately.

The power level can be changed as time is counting down. Press the **Power Level** button, turn the dial and press to enter.

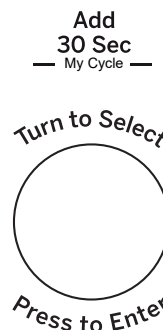

Time and Auto Microwave Features

Weight Defrost

(Do not use the shelves when microwave cooking.)

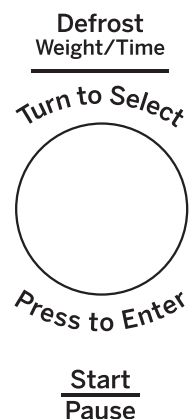

Weight Defrost automatically sets the defrosting times and power levels to give even defrosting results for meats, poultry and fish weighing up to one pound.

- Remove meat from package and place on microwave-safe dish.
1. Press the **Defrost** button once.
 2. Turn the dial to the food weight, using the Conversion Guide at right. For example, dial .5 for .5 pounds (8 oz.) Press the dial to enter.

3. Press the **Start/Pause** button to start defrosting.
 4. Turn the food over if the oven signals **TURN FOOD OVER.**
- Remove defrosted meat or shield warm areas with small pieces of foil.
 - After defrosting, most meats need to stand 5 minutes to complete defrosting.

Conversion Guide

If the weight of food is stated in pounds and ounces, the ounces must be converted to tenths (.1) of a pound.

Weight of Food in Ounces	Enter Food Weight (tenths of a pound)
1–2	.1
3	.2
4–5	.3
6–7	.4
8	.5
9–10	.6
11	.7
12–13	.8
14–15	.9

Time Defrost

(Do not use the shelves when microwave cooking.)

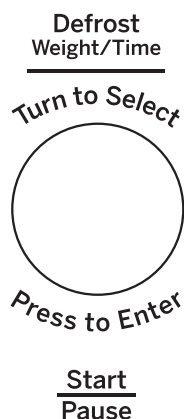

Use **Time Defrost** to defrost for a selected length of time.

1. Press the **Defrost** button twice.
2. Turn the dial to select the time you want. Press the dial to enter.
3. Press the **Start/Pause** button to start defrosting.
4. Turn the food over if the oven signals **TURN FOOD OVER.**

You may change the defrost time at any time during defrosting by turning the dial.

Power level is automatically set at 3, but can be changed. You can defrost small items quickly by raising the power level after entering the time. Power Level 7 cuts the total defrosting time in about half; Power Level 10 cuts the total time to approximately 1/3. However, food will need more frequent attention than usual.

A dull thumping noise may be heard during defrosting. This is normal when oven is not operating at **High** power.

Defrosting Tips

- Foods frozen in paper or plastic can be defrosted in the package. Closed packages should be slit, pierced or vented **AFTER** food has partially defrosted. Plastic storage containers should be partially uncovered.
- Family-size, prepackaged frozen dinners can be defrosted and microwaved. If the food is in a foil container, transfer it to a microwave-safe dish.
- Foods that spoil easily should not be allowed to sit out for more than one hour after defrosting. Room temperature promotes the growth of harmful bacteria.
- When defrosted, food should be cool but softened in all areas. If still slightly icy, return to the microwave very briefly, or let it stand a few minutes.

Time and Auto Microwave Features

Defrosting Guide		
Food	Time	Comments
Breads, Cakes		
Bread, buns or rolls (1 piece)	1/4 min.	
Sweet rolls (approx. 12 oz.)	2 to 4 min.	Rearrange after half of time.
Fish and Seafood		
Fillets, frozen (1 lb.)	6 to 9 min.	
Fruit		
Plastic pouch—1 or 2 (10-oz. package)	1 to 5 min.	
Meat		
Bacon (1 lb.)	2 to 5 min.	Place unopened package in oven. Let stand 5 minutes after defrosting.
Franks (1 lb.)	2 to 5 min.	Place unopened package in oven. Microwave just until franks can be separated. Let stand 5 minutes, if necessary, to complete defrosting.
Ground meat (1 lb.)	4 to 6 min.	Turn meat over after first half of time.
Roast: beef, lamb, veal, pork	9 to 13 min. per lb.	Use power level 10.
Steaks, chops and cutlets	4 to 8 min. per lb.	Place unwrapped meat in cooking dish. Turn over after first half of time and shield warm areas with foil. After second half of time, separate pieces with table knife. Let stand to complete defrosting.
Poultry		
Chicken, broiler-fryer, cut up (2 1/2 to 3 lbs.)	14 to 20 min.	Place wrapped chicken in dish. Unwrap and turn over after first half of time. After second half of time, separate pieces and place in cooking dish. Microwave 2 to 4 minutes more, if necessary. Let stand a few minutes to finish defrosting.
Chicken, whole (2 1/2 to 3 lbs.)	20 to 25 min.	Place wrapped chicken in dish. After first half of time, unwrap and turn chicken over. Shield warm areas with foil. To complete defrosting, run cool water in cavity until giblets can be removed.
Cornish hen	7 to 13 min. per lb.	Place unwrapped hen in oven breast-side-up. Turn over after first half of time. Run cool water in cavity until giblets can be removed.
Turkey breast (4 to 6 lbs.)	3 to 8 min. per lb.	Place unwrapped breast in microwave-safe dish breast-side-down. After first half of time, turn breast-side-up and shield warm areas with foil. Defrost for second half of time. Let stand 1 to 2 hours in refrigerator to complete defrosting.

Time and Auto Microwave Features

Power Level

The power level may be entered or changed immediately after entering the time for **Cook Time** or **Time Defrost**. The power level may also be changed during time countdown.

1. First, follow directions for **Cook Time** or **Time Defrost**.
2. Press the **Power Level** button.
3. Turn the dial clockwise to increase and counterclockwise to decrease the power level. Press the dial to enter.
4. Press the **Start/Pause** button to start cooking.

Variable power levels add flexibility to microwave cooking. The power levels on the microwave oven can be compared to the surface units on a range. Each power level gives you microwave energy a certain percent of the time. Power Level **7** is microwave energy 70% of the time. Power Level **3** is energy 30% of the time. Most cooking will be done on **High** (Power Level **10**) which gives you 100% power. Power Level **10** will cook faster but food may need more frequent stirring, rotating or turning over.

A lower setting will cook more evenly and need less stirring or rotating of the food. Some foods may have better flavor, texture or appearance if one of the lower settings is used. Use a lower power level when cooking foods that have a tendency to boil over, such as scalloped potatoes.

Rest periods (when the microwave energy cycles off) give time for the food to “equalize” or transfer heat to the inside of the food. An example of this is shown with Power Level **3** - the defrost cycle. If microwave energy did not cycle off, the outside of the food would cook before the inside was defrosted.

Here are some examples of uses for various power levels:

High 10: Fish, bacon, vegetables, heating liquids.

Med-High 7: Gentle cooking of meat and poultry; baking casseroles and reheating.

Medium 5: Slow cooking and tenderizing for stews and less tender cuts of meat.

Low 2 or 3: Defrosting; simmering; delicate sauces.

Warm 1: Keeping food warm; softening butter.

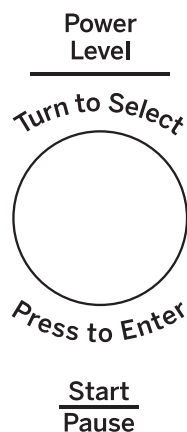

Sensor Microwave Features

Humidity Sensor

What happens when using the Sensor Features:

The Sensor Features detect the increasing humidity released during cooking. The oven automatically adjusts the cooking time to various types and amounts of food.

Do not use the Sensor Features twice in succession on the same food portion—it may result in severely overcooked or burnt food. If food is undercooked after the countdown, use **Cook Time** for additional cooking time.

NOTE: Sensor features will not operate when the oven is hot. If one of the sensor cooking buttons is pressed when the temperature inside the oven is greater than 200°F, "OVEN TOO HOT FOR SENSOR COOKING - USING ALTERNATE METHOD" will be displayed. The oven will automatically change to cook by time (follow the directions in the display) or once the oven is cool enough, the sensor features will function normally.

- The proper containers and covers are essential for best sensor cooking.



Covered

- Always use microwave-safe containers and cover them with lids or vented plastic wrap. Never use tight sealing plastic containers - they can prevent steam from escaping and cause food to overcook.



Vented

- Be sure the outside of the cooking containers and the inside of the microwave oven are dry before placing food in the oven. Beads of moisture turning into steam can mislead the sensor.



Dry off dishes so they don't mislead the sensor.

Cook

Because most cooking containers must be covered during **Cook**, this feature is best with foods that you want to steam or retain moisture.

NOTE: Use of the metal shelf with **Cook** is not recommended.

Recommended Foods

A wide variety of foods including meats, fish and vegetables can be cooked using this feature.

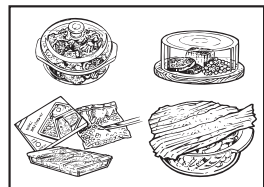

Foods not recommended

Foods that must be cooked uncovered, foods that require constant attention, foods that require addition of ingredients during cooking and foods calling for a dry look or crisp surface after cooking should not be cooked using this feature. It is best to **Cook Time** them.



Sensor Microwave Features

Steam Cook

TIMED STEAM* or SENSOR STEAM**

For best results, use steam or simmer bowl. Add 2 Tablespoons (200 ml) of water when steaming vegetables.



1. Press the **Steam Cook** pad once for Timed Steam or twice for Sensor Steam cook.
2. Turn the dial to select food type. Press dial to enter.
3. Press the dial to select the amount, size and/or doneness (if required, the oven will prompt you). Press the dial after each selection.
4. Insert food and close the door.

*Timed Steam is a pre-set time-based cook.

**Sensor Steam is a variable time based on a sensor.

Menu Selection for Sensor Steam**

For best results use 1-4 cups.

- Asparagus
- Carrots
- Potatoes
- Squash
- Brussels Sprouts
- Cauliflower
- Rice
- Zucchini

Menu Selection for Time Steam*

Food	Amount	Time
Asparagus	1 cup	3:20
	2 cups	4:25
	3 cups	5:30
Broccoli	1 cup	2:30
	2 cups	3:30
	3 cups	4:30
Brussels	1 cup	3:00
	2 cups	3:55
	3 cups	4:50
Carrots	1 cup	4:00
	2 cups	5:00
	3 cups	6:00
Cauliflower	1 cup	3:00
	2 cups	4:15
	3 cups	5:30
Chicken Breast	1 piece (6-8 oz)	5:30
	1 piece (8-10 oz)	7:00
	2 pieces (6-8 oz)	8:00
	2 pieces (8-10 oz)	9:30
Fish, 1 piece	thin filet - 1/2"	4:30
	medium filet - 1"	5:00
	thick filet - 1-1/2"	5:30
Fish - 2 pieces	thin filet - 1/2"	5:30
	medium filet - 1"	6:00
	thick filet - 1-1/2"	6:30
Green Beans	1 cup	3:00
	2 cups	3:50
	3 cups	4:40
Potatoes	1 ea	7:20
	2 ea	10:10
	3 ea	13:00
Quinoa	1 cup	18:30
Rice	1 cup	18:00
Scallops - Bay Scallops	6-10 oz	4:00
	10-16 oz	7:00
Sea Scallops	6-10 oz	5:00
	10-16 oz	8:00
Shrimp	1/2 pound	5:00
	1 pound	7:00
Squash	1 cup	4:10
	2 cups	5:15
	3 cups	6:20
Zucchini	1 cup	3:40
	2 cups	4:20
	3 cups	6:00

Sensor Microwave Features

Popcorn (Do not use the shelves when microwave cooking.)

To use the **Popcorn** feature:

1. Follow package instructions, using **Cook Time** if the package is less than 2.0 ounces or larger than 3.5 ounces. Place the package of popcorn in the center of the turntable.
2. Press the **Popcorn** button. The oven starts immediately.

If you open the door while POPCORN SENSOR is displayed, an error message will appear. Close the door, press **Cancel/Off** and begin again.

If food is undercooked after the countdown, use **Cook Time** for additional cooking time.

How to Adjust the Automatic Popcorn Setting to Provide a Shorter or Longer Cook Time

If you find that the brand of popcorn you use underpops or overpops consistently, you can add or subtract 20–30 seconds to the automatic popping time.

To subtract or add time for sensor cook, turn the dial when the time appears.



Use only with prepackaged microwave popcorn weighing 2.0 to 3.5 ounces.
NOTE: Do not use this feature twice in succession on the same food portion—it may result in severely overcooked or burnt food.

Beverage (Do not use the shelves when microwave cooking.)

The **Beverage** feature heats beverages from 6 to 12 ounces.

Press the **Beverage** button. Then oven start immediately.

Drinks heated with the **Beverage** feature may be very hot. Remove the container with care.



Reheat (Do not use the shelves when microwave cooking.)

The **Reheat** feature reheats servings of previously cooked foods or a plate of leftovers.

1. Place the cup of liquid or covered food in the oven. Press **Reheat** and choose food type.
2. The oven signals when steam is sensed and the time remaining begins counting down.

Do not open the oven door until time is counting down. If the door is opened, close it and press **Start/Pause** immediately.

After removing food from the oven, stir, if possible, to even out the temperature. Reheated foods may have wide variations in temperature. Some areas of food may be extremely hot.

If food is not hot enough after the countdown use **Cook Time** for additional reheating time.

Some Foods Not Recommended for Use With Reheat

It is best to use **Cook Time** for these foods:

- Bread products.
- Foods that must be reheated uncovered.
- Foods that need to be stirred or rotated.
- Foods calling for a dry look or crisp surface after reheating.

To subtract or add time for sensor cook, turn the dial when the time is shown.



NOTE: Do not use this feature twice in succession on the same food portion—it may result in severely overcooked or burnt food.

Selection	Food to Reheat
1	Plate
2	Soup
3	Veggies
4	Pasta

Sensor Microwave Features

Cook (Do not use the shelves when microwave cooking.)

- Place covered food in the oven and close the door. Press the Cook button. **ENTER FOOD TYPE** appears in the display.
- Turn the dial to the desired food type. Press to enter.

See the **Sensor Food Type Guide** below for specific foods and instructions.

The oven starts immediately.

NOTE: If the door was open while the control was being set, close the door and press the **Start/Pause** button to begin cooking.

If food is undercooked after the countdown, use **Cook Time** for additional cooking time.

Do not open the oven door before the countdown time is displayed—steam escaping from the oven can affect cooking performance. If the door is opened, close the door and press Start/Pause immediately.

If ground meat was selected, the oven may signal you to drain and stir the meat. Open the door, drain the meat and close the door. Press the **Start/Pause** button if necessary to resume cooking.

Cooking Tips

- When oven signals and countdown time is displayed, the door may be opened for stirring, turning or rotating food. To resume cooking, close the door and press **Start/Pause**.
- Match the amount of food to the size of container. Fill containers at least 1/2 full.
- Be sure outside of container and inside of oven are dry.
- After completion of Cook cycle, if food needs additional cooking, return food to oven and use Cook Time to finish cooking.

To subtract or add time for sensor cook, turn the dial when the time is shown.

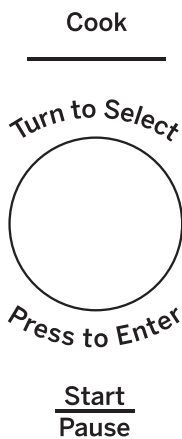

NOTE: Do not use this feature twice in succession on the same food portion—it may result in severely overcooked or burnt food.

Sensor Food Type Guide			
Food Type	Servings	Serving Size	Comments
Chicken	Bone-In Boneless	2 to 8 pieces	Use oblong, square or round dish. Cover with vented plastic wrap.
Fish	—	4 to 16 oz.	Use oblong, square or round dish. Cover with vented plastic wrap.
Ground Meat (Beef, Pork, Turkey)	—	8 to 32 oz.	Use round casserole dish. Crumble meat into dish. Cover with vented plastic wrap.
Potatoes	—	8 to 32 oz.	Pierce skin with fork. Arrange in a star pattern in center of turntable.
Vegetables	Fresh	4 to 16 oz.	Use microwave-safe casserole or bowl. Add 2 tablespoons water for each serving. Cover with lid or vented plastic wrap.
Vegetables	Frozen	4 to 16 oz.	Use microwave-safe casserole or bowl. Follow package instructions for adding water. Cover with lid or vented plastic wrap.
Vegetables	Canned	4 to 16 oz.	Use microwave-safe casserole or bowl. Cover with lid or vented plastic wrap.

Other Features

Cooking Complete Reminder

To remind you that you have food in the oven, the oven will display **FOOD IS READY** and beep once a minute until you either open the oven door or press the **Cancel/Off** button.

Start/Pause

In addition to starting many functions, **Start/Pause** allows you to stop cooking without opening the door or clearing the display.



Cancel/Off

Press the **Cancel/Off** button to stop and cancel cooking at any time.

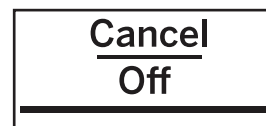

Timer On/Off

The Timer operates as a minute timer and can be used at any time, even when the oven is operating.

1. Press the **Timer** button.
2. Turn the dial to select the minutes. Press the dial to enter.
3. Turn the dial to select the seconds. Press the dial to enter
4. Press the dial or **Timer** to start.

To cancel, press the **Timer** button.

When time is up, the oven will signal. To turn off the timer signal, press **Timer**.

NOTE: The **TIMER** indicator will be lit while the timer is operating.



Steam Clean

1. Press the **Steam Clean** button.
2. Put steam bowl with 1/4 cup of water.
3. Press the dial or **Start/Pause** to start.

Once the cycle is terminated, wipe oven cavity with paper towel or cloth.



Turntable

For best cooking results, leave the turntable on. It can be turned off for large dishes.

1. Press the **Turntable On/Off** button to stop or start rotating the turntable.

Sometimes the turntable can become too hot to touch.

Be careful touching the turntable during and after cooking.



Mute On/Off

You can control sound using **Mute On/Off** button.



Control Lock-Out

You may lock the control panel to prevent the oven from being accidentally started during cleaning or being used by children.



To lock or unlock the controls, press and hold 3 seconds. When the control panel is locked, **CONTROL LOCKED** will be displayed briefly anytime a button or dial is pressed.

Other Features

Chef Connect

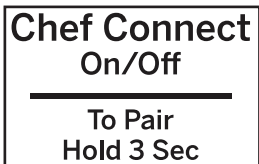
Use the **Chef Connect** feature for connecting your microwave to a Café Appliances range to sync your vent fan, cooktop surface lights and clock via Bluetooth technology.



1. You must have a **Chef Connect** enabled range. To pair your microwave for the first time, initiate the Chef Connect process on the Café Appliances range. Refer to the range owner's manual for instructions
2. On the microwave, hold **Chef Connect** button for 3 seconds. The Bluetooth icon  on the display will start flashing as the microwave starts to search and pair with your Café Appliances range. The icon  will remain ON after pairing successfully.
If a Café Appliances range is not found within 2 minutes during search mode the microwave will stop searching and the Bluetooth icon  will turn OFF.
On initial setup, the setup protocol will start.
If the **Chef Connect** feature is enabled the default settings are as follows:
 - Display clock sync: ON
 - Auto surface light: ON (HIGH setting)
 - Auto vent fan: OFF
 - Auto off: 15 minutes
3. Turn the dial to select **Surface Light Sync On/Off**. Press the dial to confirm. If on, it allows the microwave surface lights to turn on at HIGH level automatically when the paired range's cooktop burner turns ON. If OFF, the microwave surface lights will not automatically turn on when a cooktop burner turns on.

4. Turn the dial to select **Vent Fan Sync ON/OFF**. Press the dial to confirm. If ON, it allows the microwave vent fan to turn on at LOW speed automatically when the paired range's cooktop burner turns on. If OFF, the vent fan will not turn ON automatically when a cooktop burner is turned on. Pairing is now complete, the **Chef Connect** feature is now on.

NOTE: If there is no sync option selected during set up, 5 minutes after icon  turns ON, the units will return to stand-by mode and use the default settings.

After completing the setting per above steps, your microwaves vent fan and surface light could be set to turn on automatically when the cooktop burner is turned on. The cooktop and range clock display will be synced to display the same time. The vent fan and cooktop light will be set to automatically turn off 15 minutes after the cooktop burner is turned OFF. If desired, the light, fan, and auto off settings can now be changed using option in **Settings**.

Press **Chef Connect** once to temporarily turn OFF communication between the microwave and range. Press again to turn communication back ON. The icon  will illuminate when ON.

In the case of an unintended disconnect such as lost power to the microwave or range the connection will remain after power resumed. For very short power interruptions, the power may need to be reset in order to reconnect

NOTE: To unpair the microwave from the range, press and hold the Chef Connect button on the microwave for 3 seconds. The Bluetooth icon will start to flash. Press cancel or wait 2 minutes for the flashing to stop. You may need to unpair when the Café Appliances range is replaced or serviced.

Other Features

Settings

Display On/Off
Hold 3 Sec

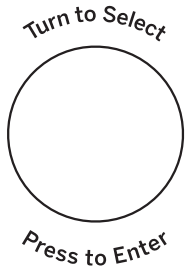

Set Clock

1. Press the **Settings** button and turn the dial to select **Clock Set**. Press the dial to enter..
2. Turn the dial to set hours. Press the dial to enter.
3. Turn the dial to set minutes. Press the dial to enter.
4. Turn the dial to set AM/PM. Press the dial to enter.

2. Turn the dial to set **Sound Level** (Mute, Low, Normal, or Loud). Press enter to activate.

Surface Light Sync

1. Press the **Settings** button and turn the dial to select **Surface Light Sync**. Press the dial to enter.
2. Turn the dial to select **Sync Mode** (Off, Low, High).
3. Press the dial to activate.

Clock Mode

Clock Mode can be set for 12 hours and 24 hours.

1. Press the **Settings** button and turn the dial to select **Clock Mode**. Press the dial to enter.
2. Turn the dial to set 12 hours or 24 hours **Clock Mode**. Press enter to activate.

Vent Fan Sync

1. Press the **Settings** button and turn the dial to select **Vent Fan Sync**. Press the dial to enter.
2. Turn the dial to select **Vent Fan Sync Mode** (Off, Low, Medium, High or Boost).
3. Press the dial to activate.

Display Speed

Display Speed can be adjusted for Slow, Normal, or Fast

1. Press the **Settings** button and turn the dial to select **Display Speed**. Press the dial to enter.
2. Turn the dial to set **Display Speed** (Slow, Normal, Fast). Press enter to activate.

Sync Auto Off

1. Press the **Settings** button and turn the dial to select **Sync Auto Off**. Press the dial to enter.
2. Turn the dial to select **Sync Auto Off** (up to 15 minutes and manual). Press enter to activate.

My Cycle

The Add 30 Sec button can be adjusted to the My Cycle feature.

1. Press **Setting** button and turn the dial to select **MyCycle**. Press the dial to enter.
2. Turn the dial to select time (from 5 Sec to 60 Sec) and press the dial to complete the setting.

Sound Level

Sound Level can be adjusted for Mute, Low, Normal or Loud.

1. Press the **Settings** button and turn the dial to select **Sound Level**. Press the dial to enter.

Filter Replace Reminder

The charcoal/grease filter should be replaced when it is noticeably dirty / discolored (usually after 6-12 months, depending on hood usage) or filter replacement LED is on.

When the Filter Replace LED turned on, replace filter and press **Reset Filter**

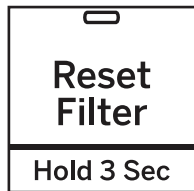

Surface Light

Press **Surface Light** once for bright light, twice for the night light or a third time to turn the light off.



Vent Fan

The vent fan removes steam and other vapors from surface cooking.

Press **Vent Fan** once for high fan speed, twice for medium fan speed, three times for low fan speed or a fourth time to turn the fan off.

Vent fan will turn on automatically when the cooktop burner is turned on with **Chef Connection**.



Automatic Fan

An automatic fan feature protects the microwave from too much heat rising from the cooktop below it. It automatically turns on if it senses too much heat.

If you have turned the fan on you may find that you cannot turn it off. The fan will automatically turn off when the internal parts are cool. It may stay on for 30 minutes or more after the cooktop and microwave controls are turned off.

Microwave Terms

Term	Definition
Arcing	<p>Arcing is the microwave term for sparks in the oven. Arcing is caused by:</p> <ul style="list-style-type: none"> ■ metal or foil touching the side of the oven. ■ foil that is not molded to food (upturned edges act like antennas). ■ metal such as twist-ties, poultry pins, gold-rimmed dishes. ■ recycled paper towels containing small metal pieces. ■ plates or dishes with a metallic trim or glaze with a metallic sheen.
Covering	<p>Covers hold in moisture, allow for more even heating and reduce cooking time. Venting plastic wrap or covering with wax paper allows excess steam to escape.</p>
Shielding	<p>In a regular oven, you shield chicken breasts or baked foods to prevent over-browning. When microwaving, you use small strips of foil to shield thin parts, such as the tips of wings and legs on poultry, which would cook before larger parts.</p>
Standing Time	<p>When you cook with regular ovens, foods such as roasts or cakes are allowed to stand to finish cooking or to set. Standing time is especially important in microwave cooking. Note that a microwaved cake is not placed on a cooling rack.</p>
Venting	<p>After covering a dish with plastic wrap, you vent the plastic wrap by turning back one corner so excess steam can escape.</p>

Care and Cleaning

Helpful Hints

An occasional thorough wiping with a solution of baking soda and water keeps the inside fresh.

Be certain the oven control is turned off before cleaning any part of this oven.



How to Clean the Inside

Walls, Floor, Inside Window, Metal and Plastic Parts on the Door

Some spatters can be removed with a paper towel; others may require a damp cloth. Remove greasy spatters with a sudsy cloth, then rinse with a damp cloth. Do not use abrasive cleaners or sharp utensils on oven walls.

Never use a commercial oven cleaner on any part of your microwave.

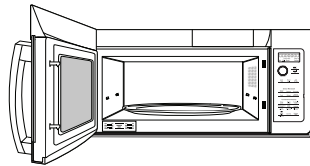

Removable Turntable and Turntable Support

To prevent breakage, do not place the turntable into water just after cooking. Wash it carefully in warm, sudsy water or in the dishwasher. The turntable and support can be broken if dropped. Remember, do not operate the oven in the microwave mode without the turntable and support seated and in place.



How to Clean the Outside

We recommend against using cleaners with ammonia or alcohol, as they can damage the appearance of the microwave oven. If you choose to use a common household cleaner, first apply the cleaner directly to a clean cloth, then wipe the soiled area.

Case

Clean the outside of the microwave with a sudsy cloth. Rinse and then dry. Wipe the window clean with a damp cloth.

Control Panel

Wipe with a damp cloth. Dry thoroughly. Do not use cleaning sprays, large amounts of soap and water, abrasives or sharp objects on the panel—they can damage it. Some paper towels can also scratch the control panel.

Door Panel

Before cleaning the front door panel, make sure you know what type of panel you have. Refer to the eighth digit of the model number. “S” is stainless steel, “L” is CleanSteel and “B”, “W” or “C” are plastic colors.

Stainless Steel (on some models)

The stainless steel panel can be cleaned with Stainless Steel Magic or a similar product using a clean, soft cloth. Apply stainless cleaner carefully to avoid the surrounding plastic parts. Do not use appliance wax, polish, bleach or products containing chlorine on Stainless Steel finishes.

Plastic Color Panels

Use a clean, soft, lightly dampened cloth, then dry thoroughly.

Door Seal

It's important to keep the area clean where the door seals against the microwave. Use only mild, non-abrasive detergents applied with a clean sponge or soft cloth. Rinse well.

Bottom

Clean off the grease and dust on the bottom often. Use a solution of warm water and detergent.

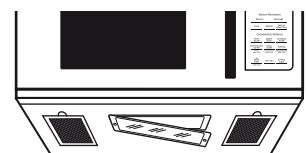
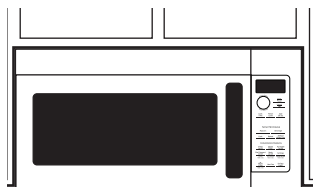

Replacing the Light Bulb

Cooktop Light/Nite Light

Replace with LED lamp. See back cover for ordering online at cafeappliances.com.

1. To replace the cooktop light/nite light, first disconnect the power at the main fuse or circuit breaker panel, or pull the plug.
2. Remove the screw from the side of the light compartment cover and lower the cover until it stops.
3. Be sure the LED lamp is cool before removing. Remove a screw and connector from LED lamp.
4. Connect LED lamp and secure using the screw. Raise the light cover and replace the screw. Connect electrical power to the oven.

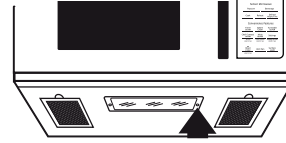

Exhaust Feature

Vent Fan

The vent fan has two metal reusable vent filters.

Models that recirculate air back into the room also use a charcoal filter.

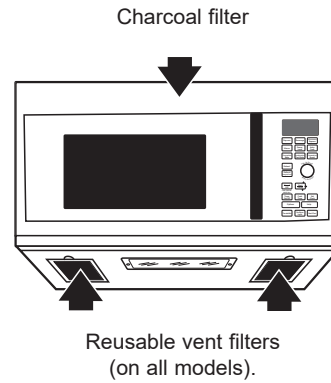

Reusable Vent Filters

The metal filters trap grease released by foods on the cooktop. They also prevent flames from foods on the cooktop from damaging the inside of the oven.

For this reason, the filters must always be in place when the hood is used. The vent filters should be cleaned once a month, or as needed.

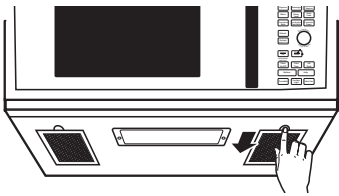

Removing and Cleaning the Filters

To remove, slide them to the rear using the tabs. Pull down and out.

To clean the vent filters, soak them and then swish around in hot water and detergent. Don't use ammonia or ammonia products because they will darken the metal. Light brushing can be used to remove embedded dirt.

Rinse, shake and let dry before replacing.

To replace, slide the filters into the frame slots on the back of each opening. Press up and to the front to lock into place.

Charcoal Filter

The charcoal filter cannot be cleaned. It must be replaced. See back cover for ordering online at cafeappliances.com

If the model is not vented to the outside, the air will be recirculated through a disposable charcoal filter that helps remove smoke and odors.

The charcoal filter should be replaced when it is noticeably dirty or discolored (usually after 6 to 12 months, depending on usage). See **Optional Kits** page 30, for more information.

CHARCOAL FILTER REPLACEMENT

1. **Unplug** the microwave oven.
2. **Remove** the vent grille mounting screws.
3. **Tip** the grille forward, then **lift out** to remove.
4. **Remove** the charcoal filter.
5. **Slide a new charcoal filter into place.**
6. **Slide** the bottom of the vent grille into place. **Push** the top until it snaps into place. **Replace** the mounting screws
7. **Plug** in the microwave oven.

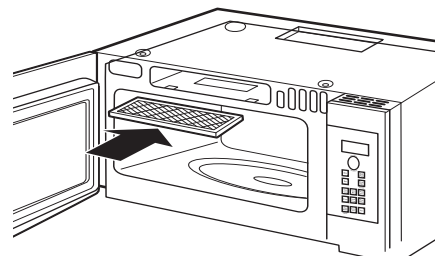

Troubleshooting Tips... Before you call for service

Save time and money! Review the charts on the following pages first and you may not need to call for service.

Problem	Possible Cause	What To Do
Oven will not start	A fuse in your home may be blown or the circuit breaker tripped.	Replace fuse or reset circuit breaker.
	Power surge.	Unplug the microwave oven, then plug it back in.
	Plug not fully inserted into wall outlet.	Make sure the 3-prong plug on the oven is fully inserted into wall outlet.
	Door not securely closed.	Open the door and close securely.
Floor of the oven is warm even when the oven has not been used	Heat from the cooktop light may make the floor get warm.	This is normal.
"CONTROL LOCK IS ON" appears on display	The control has been locked.	Press and hold Mute On/Off for about 3 seconds to unlock the control.
You hear an unusual low-tone beep	You have tried to change the power level when it is not allowed.	Many of the oven's features are preset and cannot be changed.
"SENSOR ERROR" appears on display	When using a Sensor feature, the door was opened before steam could be detected	Do not open door until steam is sensed and time is shown counting down on display
	Steam not detected in maximum amount of time	Use TIME COOK to heat for more time
Food amount too large for Sensor Reheat	Sensor Reheat is for single servings of recommended foods	Use TIME COOK for large amounts of food

Things That Are Normal With Your Microwave Oven

- Steam or vapor escaping from around the door.
- Light reflection around door or outer case.
- Dimming oven light and change in the blower sound at power levels other than high.
- Dull thumping sound while oven is operating.

Troubleshooting Tips... Before you call for service

FEDERAL COMMUNICATIONS COMMISSION RADIO FREQUENCY INTERFERENCE STATEMENT (U.S.A. ONLY)

This equipment generates and uses ISM frequency energy and if not installed and used properly, that is in strict accordance with the manufacturer's instructions, may cause interference to radio and television reception. It has been type tested and found to comply with limits for ISM Equipment pursuant to part 18 of FCC Rules, which are designed to provide residential installation.

However, there is no guarantee that interference will not occur in a particular installation. If this equipment does cause interference to radio or television reception, which can be determined by turning the equipment off and on, the user is encouraged to try to correct the interference by one or more of the following:

- Reorient the receiving antenna of the radio or television.
- Relocate the Microwave Oven with respect to the receiver.
- Move the microwave oven away from the receiver.
- Plug the microwave oven into a different outlet so that the microwave oven and the receiver are on different branch codes.

The manufacturer is not responsible for any radio or TV interference caused by unauthorized modification to this microwave oven. It is the responsibility of the user to correct such interference.

This equipment has been tested and found to comply with the limits for a Class B digital device, pursuant to part 15 of the FCC Rules. These limits are designed to provide reasonable protection against harmful interference in a residential installation. This equipment generates, uses and can radiate radio frequency energy and, if not installed and used in accordance with the instructions, may cause harmful interference to radio communications. However, there is no guarantee that interference will not occur in a particular installation. If this equipment does cause harmful interference to radio or television reception, which can be determined by turning the equipment off and on, the user is encouraged to try to correct the interference by one or more of the following measures:

- Reorient or relocate the receiving antenna.
- Increase the separation between the equipment and receiver.
- Connect the equipment into an outlet on a circuit different from that to which the receiver is connected.
- Consult the dealer or an experienced radio/TV technician for help.

To satisfy FCC RF exposure requirements, a separation distance of 20 cm or more should be maintained between the antenna of this device and persons during device operation.

To ensure compliance, operations at closer than this distance is not recommended.

▲ WARNING Any changes or modifications to this unit not expressly approved by the party responsible for compliance could void the user's authority to operate the equipment.

Café Microwave Oven Limited Warranty

cafeappliances.com

All warranty service is provided by our Factory Service Centers, or an authorized service technician. To schedule service online, visit us at cafeappliances.com/service.

For the period of	Café will replace
One year From the date of the original purchase	Any part of the oven which fails due to a defect in materials or workmanship. During this limited one-year warranty , Café Appliances will also provide, free of charge , all labor and related service costs to replace the defective part when the unit is serviced.
Five years From the date of the original purchase	The magnetron tube , if the magnetron tube fails due to a defect in materials or workmanship. During this five-year limited warranty , you will be responsible for any labor or in-home service costs.

What Café will not cover:

- Service trips to your home to teach you how to use the product.
- Improper installation, delivery or maintenance. If you have an installation problem, contact your dealer or installer. You are responsible for providing adequate electrical, exhausting, and other connecting facilities.
- Failure of the product or damage to the product if it is abused, misused (for example, cavity arcing from wire rack or metal/foil), or used for other than the intended purpose or used commercially.
- Replacement of house fuses or resetting of circuit breakers.
- Damage to the product caused by accident, fire, floods or acts of God.
- Incidental or consequential damage caused by possible defects with this appliance.
- Damage caused after delivery.
- Product not accessible to provide required service.
- Service to repair or replace light bulbs, except for LED lamps.
- Damage to the finish, such as surface rust, tarnish, or small blemishes not reported within 48 hrs of delivery.

EXCLUSION OF IMPLIED WARRANTIES

Your sole and exclusive remedy is product repair as provided in this Limited Warranty. Any implied warranties, including the implied warranties of merchantability or fitness for a particular purpose, are limited to one year or the shortest period allowed by law.

This limited warranty is extended to the original purchaser and any succeeding owner for products purchased for home use within the USA. If the product is located in an area where service by a Café Appliances Authorized Servicer is not available, you may be responsible for a trip charge or you may be required to bring the product to an Authorized Café Appliances Service location for service. In Alaska, the limited warranty excludes the cost of shipping or service calls to your home.

Some states do not allow the exclusion or limitation of incidental or consequential damages. This limited warranty gives you specific legal rights, and you may also have other rights which vary from state to state. To know what your legal rights are, consult your local or state consumer affairs office or your state's Attorney General.

Warrantor: GE Appliances, a Haier company

Louisville KY,40225

Staple your receipt here. Proof of the original purchase date is needed to obtain service under the warranty.

Optional Accessories

Available at extra cost from your Café Appliances supplier.

Filler Panel Kit

JX36BSS - Stainless

When replacing a 36" range hood, filler panel kits fill in the additional width to provide a custom built-in appearance.

For installation between cabinets only; not for end-of-cabinet installation. Each kit contains two 3" wide filler panels.

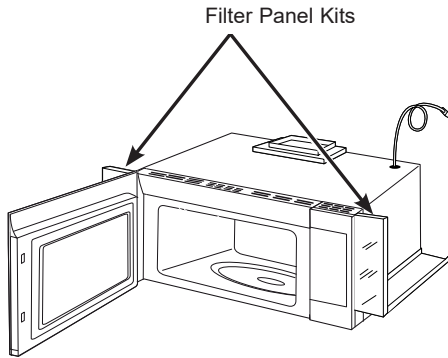

Recirculating Charcoal Filter Kit

Filter kits are used when the microwave oven cannot be vented to the outside.

15" Cabinet Installation Kit

For use when installing with 15" depth cabinets.

Available at extra cost from your Café Appliances supplier, or see the Café Appliances Service numbers.

Consumer Support

Café Website

Have a question or need assistance with your appliance? Try the Café Appliances Website 24 hours a day, any day of the year! You can also shop for more great Café Appliances products and take advantage of all our on-line support services designed for your convenience. cafeappliances.com

Register Your Appliance

Register your new appliance on-line at your convenience! Timely product registration will allow for enhanced communication and prompt service under the terms of your warranty, should the need arise. You may also mail in the pre-printed registration card included in the packing material. cafeappliances.com/register

Schedule Service

Expert Café repair service is only one step away from your door. Get on-line and schedule your service at your convenience any day of the year. cafeappliances.com/service

Extended Warranties

Purchase a Café extended warranty and learn about special discounts that are available while your warranty is still in effect. You can purchase it on-line anytime. Café Appliances Services will still be there after your warranty expires. cafeappliances.com/extended-warranty

Remote Connectivity

For assistance with wireless network connectivity (for models with remote enable), visit our website at cafeappliances.com/connect

Parts and Accessories

Individuals qualified to service their own appliances can have parts or accessories sent directly to their homes (VISA, MasterCard and Discover cards are accepted). Order on-line today 24 hours every day. cafeappliances.com/parts

Instructions contained in this manual cover procedures to be performed by any user. Other servicing generally should be referred to qualified service personnel. Caution must be exercised, since improper servicing may cause unsafe operation.

Contact Us

If you are not satisfied with the service you receive from Café Appliances, contact us on our Website with all the details including your phone number, or write to: General Manager,