

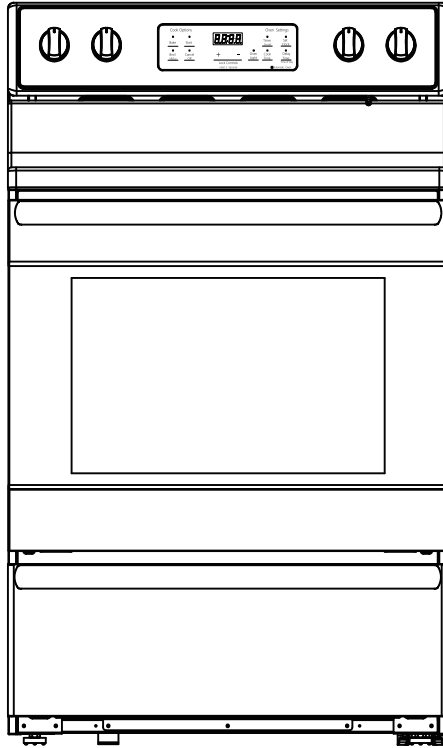

30" Standard Electric Range User Manual



EER34MSCW/EER34MSCS/EER34MSCB

USERS MANUAL

CAUTION: To Reduce The Risk Of Injury, User Must Read And Understand Operators Manual. Save These Instructions For Future Reference.

IMPORTANT

- 1. Please read Owners Manual.**
- 2. DO NOT RETURN TO STORE before calling Customer Service with questions or problems.**

For service, support and warranty information:

Call 888.842.3577, email us at customerservice

@elementelectronics.com or visit www.elementelectronics.com

TABLE OF CONTENTS

SAFETY INFORMATION	4
Anti-Tip Bracket	5
General Safety.	5
PARTS AND FEATURES	7
Hot Surface Indicator Light	7
Control Panel Diagram	7
Ceramic Glass Cooktop	8
COOKWARE	9
ELECTRONIC RANGE CONTROLS	11
Control Panel Diagram	11
Control Knob	11
Setting Clock	12
Cancel/Off	12
Oven Lights	12
Start	12
Timer	12
Oven Temperature Format	12
Delay Time.	13
Lock Controls	13
OVEN USE	14
Positioning Racks and Bakeware	14
Preheating the Oven.	15
Bake	15
Broil	15
Cook Time.	16
Food Safety	16
OVEN CARE	17
Oven Door	17
Oven Gasket.	18
Oven Light	18
Cooktop Cleaning	19
General Cleaning	20
TROUBLESHOOTING TIPS	21
WARRANTY	22
CUSTOMER SERVICE	22

SAFETY INFORMATION

NOTE: PLEASE READ ALL SAFETY INSTRUCTIONS BEFORE USING THE APPLIANCE. There are important safety messages in this manual for the appliance. Failure to follow instructions may result in potential safety hazards to the product and/or cause bodily injury.

All safety messages will explain what the potential hazards are, explain how to reduce the chance of injury, and state what can happen if the instructions are not followed.

SYMBOL MEANING

ALL SAFETY MESSAGES WILL EXPLAIN WHAT THE POTENTIAL HAZARDS ARE, EXPLAIN HOW TO REDUCE THE CHANCE OF INJURY, AND STATE WHAT CAN HAPPEN IF THE INSTRUCTIONS ARE NOT FOLLOWED.

	This is the safety alert symbol.
	This symbol alerts you to potential hazards that can hurt or kill you and others.
	All safety messages will follow the safety alert symbol with either the word: DANGER or WARNING.
	ALL SAFETY MESSAGES WILL EXPLAIN WHAT THE POTENTIAL HAZARDS ARE, EXPLAIN HOW TO REDUCE THE CHANCE OF INJURY, AND STATE WHAT CAN HAPPEN IF THE INSTRUCTIONS ARE NOT FOLLOWED.

▲ DANGER:

YOU MAY BE SERIOUSLY INJURED OR KILLED IF YOU DO NOT IMMEDIATELY FOLLOW INSTRUCTIONS!

DO NOT STORE OR USE GASOLINE OR OTHER FLAMMABLE VAPORS AND LIQUIDS IN THE VICINITY OF THIS OR ANY OTHER APPLIANCE.

▲ WARNING:

IF THE INFORMATION IN THIS MANUAL IS NOT FOLLOWED EXACTLY, A FIRE OR EXPLOSION MAY RESULT IN CAUSING PROPERTY DAMAGE, PERSONAL INJURY, OR DEATH!

YOU MAY BE SERIOUSLY INJURED OR KILLED IF YOU DO NOT FOLLOW INSTRUCTIONS!

SAFETY INFORMATION (continued)

ANTI-TIP BRACKET

The range will not tip during normal use. However, the range can tip if you apply too much force or weight to the open door without the anti-tip bracket fastened down properly.

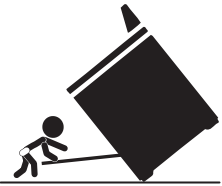
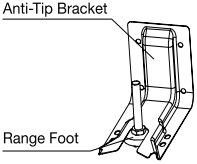
▲WARNING:	TIP OVER HAZARD
	<p>A child or adult can tip the range and be killed.</p> <p>Make sure the anti-tip bracket has been properly installed and secured per the installation instructions.</p> <p>Re-secure the anti-tip bracket if range is moved.</p> <p>Do not operate the range without the anti-tip bracket installed and secured.</p> <p>Failure to follow these instructions can result in death or serious burns to adults and children.</p>
	<p>TO VERIFY THE ANTI-TIP BRACKET IS INSTALLED AND SECURED PROPERLY:</p> <ol style="list-style-type: none">1. Slide range forward2. Look for the anti-tip bracket attached to the floor or wall, then slide range back so rear range foot is under anti-tip bracket.3. If the range can be tipped away from the wall, the range has not been secured in place. Repeat steps 1-2 to ensure rear range foot is set properly. <p>NOTE: SEE SAFETY INSTRUCTIONS BELOW FOR FURTHER DETAILS.</p>

GENERAL SAFETY INSTRUCTIONS

▲WARNING:	TO REDUCE THE RISK OF FIRE, ELECTRICAL SHOCK, INJURY TO PERSONS, OR DAMAGE WHEN USING THE RANGE, FOLLOW BASIC PRECAUTIONS, INCLUDING THE FOLLOWING:
------------------	--

Before using your appliance, make sure all the packaging material is removed from the exterior and interior parts of the range.

Do not climb, sit, stand, or hang on any parts of the appliance.

To reduce the risk of tipping, the range must be secured by properly installing the anti-tip bracket.

To check if the device is installed properly, slide the range forward, look for the anti-tip bracket attached to the floor or wall, then slide the range back so the rear range foot is under the anti-tip bracket.

To ensure proper installation, be sure the range is installed correctly and grounded by a qualified technician.

Before performing any service on your appliance, make sure to disconnect the power supply and the range is unplugged.

Service Repair: Do not repair or replace any part of the oven unless specifically recommended in the manual. All other servicing should be referred to a qualified technician.

SAFETY INFORMATION

▲ DANGER:

NEVER USE THE RANGE FOR WARMING OR HEATING THE ROOM. DOING SO MAY RESULT IN CARBON MONOXIDE POISONING AND OVERHEATING THE OVEN!

Do Not Leave Children Unattended Near Range! Children should not be left alone or unattended in area where range is in use. This can lead to potential burns, injury, or death.

Wear Proper Apparel: Loose-fitting or hanging garments should never be worn while using the range. Excess material has the potential to catch on fire and cause burns.

Storage in the Oven: Do not store any items or flammable materials inside the oven. Items inside could ignite and start a fire.

Do Not Use Water on Grease Fires: In case of a grease fire, smother fire or flame with well-fitted lid or use a fire extinguisher.

Use Only Dry Potholders: Do not use wet or damp potholders on hot surfaces. May result in burns from steam! Do not let potholder touch hot heating elements. Do not use a towel or other bulky cloth.

Use Care When Opening Oven Door: Let hot air or steam escape before removing or inserting food into the oven.

Do Not Heat Unopened Food Containers: Unopened food containers will build-up pressure and will cause container to burst and result in injury.

Keep Oven Vent Ducts Unobstructed: The air inlets and outlets are necessary for the range to operate properly.

Placement of Oven Racks: Always place oven racks in desired position when oven is off. If a rack must be moved while oven is hot, use potholders to protect hands from hot heating elements in the oven.

DO NOT TOUCH HEATING ELEMENTS OR INTERIOR SURFACES OF OVEN: Heating elements may be hot even though they are dark in color. Interior surfaces of the oven will become hot enough to cause burns! Potential hot surfaces include, burners, and other exterior surfaces around the oven.

During and After Use: Do not touch, or let clothing or other flammable materials come in contact with the heating elements and/or interior surfaces of oven until they have had sufficient time to cool.

Potential Surfaces of the Oven May Become Hot Enough to Cause Burns: Among these surfaces are the oven vent openings, surfaces near these openings, oven door, and windows of the oven door.

Clean Oven Gasket with a Mild Soap and Warm Water: The gasket is essential for a good seal. Care should be taken not to rub, damage, or move the gasket.

Do Not Use Oven Cleaners: No commercial oven cleaner or oven liner protective coating of any kind should be used in or around any part of the oven.

Clean Only Parts Listed in Manual.

READ AND SAVE THESE SAFETY INSTRUCTIONS FOR FUTURE REFERENCE.

1. Please read Owners Manual.
2. **DO NOT RETURN TO STORE** before calling Customer Service with questions or problems.

PARTS AND FEATURES

RANGE PARTS DIAGRAM:

- A. Control Knob
- B. Control Panel
- C. Control Knob
- D. Ceramic Glass Surface
- E. Oven Light
- F. Oven Racks
- G. Gasket
- H. Oven Door with Handle
- I. Storage Drawer
- J. Broiler
- K. Oven Vent
- L. Adjustable Feet x 4

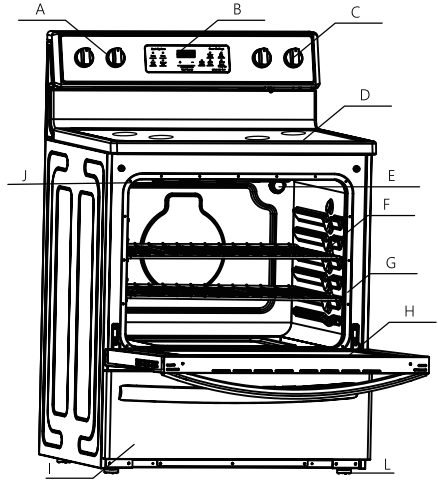

⚠ WARNING:	BURN HAZARD
	COOKTOP SURFACE MAY STILL BE HOT EVEN THOUGH ELEMENT SURFACE IS NOT GLOWING RED.
	CHOKING HAZARD
	SMALL PARTS. NOT FOR CHILDREN UNDER 3 YEARS OLD.

HOT SURFACE INDICATOR LIGHT

Hot Surface Indicator Light is located on the front center area of the glass cooktop.

The Hot Surface Indicator Light will glow if any surface cooking area is too hot to touch, even after the surface cooking area is turned off. Use caution as the cooktop surface may still be warm after the hot surface indicator light has shut off.

CONTROL PANEL DIAGRAM

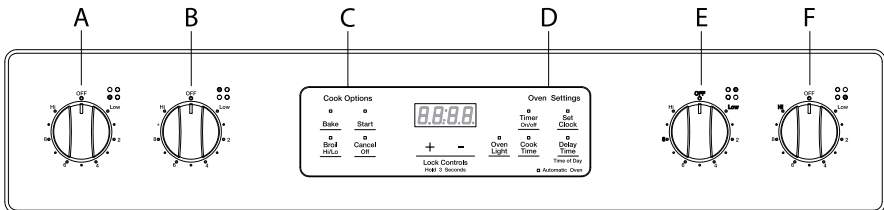

A	FRONT LEFT BURNER	C	COOK OPTION	E	REAR RIGHT BURNER
B	REAR LEFT BURNER	D	OVEN SETTINGS	F	FRONT RIGHT BURNER

PARTS AND FEATURES (continued)

⚠ WARNING:	FIRE HAZARD
	Never leave the range unattended Turn off controls when not cooking Failure to follow these instructions can result in death or fire When range is in use, the entire cooktop may become hot!

CERAMIC GLASS COOKTOP

The surface cooking area will glow red when an element is on. Some parts of the surface cooking area may not glow red when an element is on. This is normal operation. It will also randomly cycle off and back on again, even while on High, to keep the cooktop from extreme temperatures.

It is normal for the surface of ceramic glass to change color when surface cooking areas are hot. As the glass cools, it will return to its original color.

Clean the cooktop after each use to help avoid scratches, pitting, abrasions and to condition the glass surface. Ceramic glass cooktop cleaner and a cooktop scraper are also recommended for stubborn soils. Do not use abrasive cleaners, cleaning pads or harsh chemicals for cleaning. Refer to the Oven Care section for additional information.

Use flat-bottomed cookware for best heat conduction and energy efficiency. Cookware with rounded, warped, ribbed, or dented bottoms could cause uneven heating and poor cooking results.

Cookware designed with slightly indented bottoms or small expansion channels can be used.

Make sure the bottoms of pots and pans are clean and dry before using them. Residue and water can leave deposits on ceramic glass when heated.

Avoid storing jars or cans above the cooktop. Dropping a heavy or hard object onto the cooktop could crack the cooktop.

To avoid damage to the cooktop, do not leave a hot lid on the cooktop. As the cooktop cools, air can become trapped between the lid and the cooktop, and the ceramic glass could break when the lid is removed.

For foods containing sugar in any form, clean up all spills and soils as soon as possible. Allow the cooktop to cool down slightly. Then, while wearing oven mitts, remove the spills using a scraper while the surface is still warm. If sugary spills are allowed to cool down, they can adhere to the cooktop and can cause pitting and permanent marks.

To avoid scratches, do not slide cookware or bakeware across the cooktop. Aluminum or copper bottoms and rough finishes on cookware or bakeware could leave scratches or marks on the cooktop.

Do not cook popcorn in pre-packaged aluminum containers on the cooktop. They could leave aluminum marks that cannot be removed completely.

To avoid damage to the cooktop, do not allow objects that could melt, such as plastic or aluminum foil, to touch any part of the entire cooktop.

To avoid damage to the cooktop, do not use the cooktop as a cutting board.

To avoid damage to the cooktop, do not cook foods directly on the cooktop.

COOKWARE

▲WARNING:

STORAGE DRAWER

WHEN THE OVEN IS IN USE, THE DRAWER MAY BECOME HOT. DO NOT STORE PLASTICS, CLOTH, OR OTHER ITEMS THAT COULD MELT OR BURN IN THE DRAWER.

▲WARNING:

OVEN VENT

THE OVEN VENT RELEASES HOT AIR AND MOISTURE FROM THE OVEN, IT SHOULD NOT BE BLOCKED OR COVERED. DO NOT SET PLASTICS, PAPER OR OTHER ITEMS THAT COULD MELT OR BURN NEAR THE OVEN VENT.

▲WARNING:

CLEANING COOKTOP

TO AVOID PERMANENT DAMAGE TO THE COOKTOP SURFACE AND TO MAKE SPILLS EASIER TO REMOVE, CLEAN THE COOKTOP AFTER EACH USE.

▲WARNING:

EMPTY COOKWARE

DO NOT LEAVE EMPTY COOKWARE ON A HOT SURFACE COOKING AREA, ELEMENT, OR SURFACE BURNER.

Ideal cookware should have a flat bottom, straight sides and a well fitted lid, and the material should be of medium-to-heavy thickness.

Rough finishes may scratch the cooktop or grates. Aluminum and copper may be used as a core or base in cookware.

Cookware material is a factor in how quickly and evenly heat is transferred, which affects cooking results.

Cookware with nonstick surfaces should not be used under the broiler.

Check for flatness by placing the straight edge of a ruler across the bottom of the cookware. While you rotate the ruler, no space or light should be visible between it and the cookware.

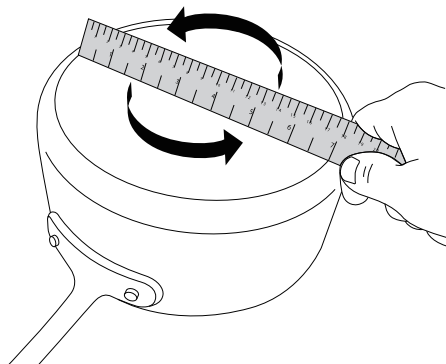

COOKWARE (continued)

Use flat-bottomed cookware for best cooking results and energy efficiency. The cookware should be about the same size as the cooking area outlined on the cooktop. Cookware should not extend more than ½" (1.3 cm) outside the area.

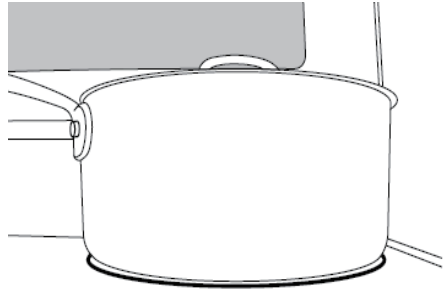

Use the following chart as a general guide for cookware material characteristics. Individual results may vary.

COOKWARE	CHARACTERISTICS
Aluminum	Heats quickly and evenly. Suitable for all types of cooking. Medium or heavy thickness is best for most cooking tasks.
Cast iron	Heats slowly and evenly. Good for browning and frying. Maintains heat for slow cooking.
Ceramic or Ceramic Glass	Follow manufacturers instructions. Heats slowly, but unevenly. Ideal results on low to medium heat settings. May scratch the cooktop.
Porcelain Enamel-On Steel or Cast Iron	See stainless steel or cast iron.
Stainless Steel	Heats quickly, but unevenly. A core/base of aluminum or copper on stainless steel provides even heating.

ELECTRIC RANGE CONTROL

The oven's controls are accessed through its control panel.

CONTROL PANEL DIAGRAM

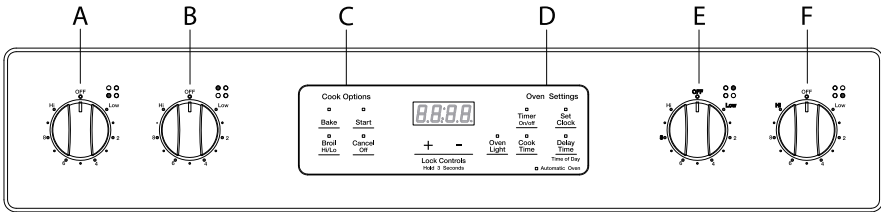

A	FRONT LEFT BURNER	C	COOK OPTION	E	REAR RIGHT BURNER
B	REAR LEFT BURNER	D	OVEN SETTINGS	F	FRONT RIGHT BURNER

CONTROL KNOB

The control knobs can be set to anywhere between Hi and Low.

Push in and turn to setting

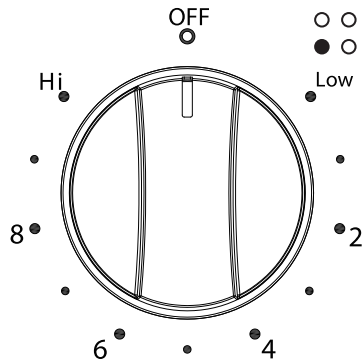

When power is first supplied to the range or if a power failure occurs, 12:00 will appear on the display and flash. When the oven is not in use, the display will show only the time.

NOTES:

The clock function on this range has two available time settings. 12-hour or 24-hour time.

The range is programmed with the 12-hour time mode set as the default setting.

Before setting the clock, make sure the oven and timer are off.

If you would like to change the time mode from the default setting, you must change it before setting the clock.

HOW TO SELECT THE 12-HOUR OR 24-HOUR TIME SETTING:

- 1) To switch the clock mode from 12-hour or 24-hour time, press the Set Clock pad, and hold for 3 seconds.
- 2) After 3 seconds, 12 or 24 will appear on the display.

ELECTRIC RANGE CONTROL (continued)

If the display shows 12 you are switching the time mode to 12-hour time.

If the display shows 24 you are switching the time mode to 24-hour time.

- 3) Once your desired time mode appears, the display will automatically switch back to the clock display indicating that your time mode has been updated.

HOW TO SET THE CLOCK

After the desired time setting mode has been selected you can now set the clock time on the range.

- 1) To set the clock, press the Set Clock pad, and the hours will begin to flash, press the + or - pad to adjust the hour. To lock in the hour, press the Set Clock pad.
- 2) Once the hour is locked in, the minutes will begin to flash on the display, next press the + or - pad to adjust the minutes. To lock in the minutes, press the Set Clock pad.
- 3) The clock time on your range is now set.

CANCEL/OFF

The Cancel/Off pad stops any function except the Control Lock.

OVEN LIGHT

Press the Oven Light pad to turn the lights on or off. When the Bake or Broil start, the Oven Light will light up automatically.

START

The Start Pad begins the oven function. If the Start pad is not pressed within 30 seconds after pressing a function pad, the display will begin to flash for 30 seconds, then 5 reminder tones will sound, and PUSH" icon and On icon will begin to flash alternately on the display for 30 seconds. If the Start pad is not pressed the oven function will be canceled and the display will return to showing the clock time.

TIMER

The timer can be set in hours or minutes up to 11 hours and 59 minutes (in the 12-hour time mode; 23-hours and 59 minutes in the 24-hour time mode), and counts down the set time programmed into the system. The timer does not start or stop the oven.

HOW TO SET THE TIMER

1. To set the Timer, press the Timer On/Off pad. The Timer indicator light will light up.
2. Next, the display will begin to flash, to set the desired hour or minutes, press the + or - pad.
3. Then press the Timer On/Off pad to begin the Timer.
4. When the set time ends, the end-of-cycle tones will sound.
5. Press the Timer On/Off pad to stop the timer and the reminder tones.

NOTE: If you would like to stop the Timer at any time, press the Timer On/Off pad twice.

OVEN TEMPERATURE FORMAT

The default temperature scale setting for the oven is set to Fahrenheit.

When using the oven, the oven temperature on the display will appear in Fahrenheit (F). However, if you would like to change the temperature scale to Celsius (C), please see directions below.

ELECTRIC RANGE CONTROL (continued)

HOW TO CHANGE THE OVEN TEMPERATURE SCALE TO CELSIUS:

1. To change the oven temperature scale to Celsius (C), press the Bake pad and hold for 3 seconds.
2. Next, the letter C will appear on the display for a few seconds.
3. The C will disappear from the display, and the clock time will reappear on the display indicating the oven temperature scale has been switched.
4. When using the Bake function, the oven temperature will now display the letter C next to the temperature.

HOW TO CHANGE THE OVEN TEMPERATURE SCALE BACK TO FAHRENHEIT:

To change the oven temperature scale back to Fahrenheit (F), repeat above steps 1-3. However, during the adjustment the letter F will appear on the display instead of a C.

DELAY TIME

The delay time function is available in the Bake or Broil mode.

HOW TO SET THE DELAY TIME:

- 1) To set the Delay Time, press the Delay Time pad, and the display will begin to flash.
- 2) Next, press the + or pad to set the time to when you would like your cooking time to begin.
- 3) Once you have set your desired delay time, press the Delay Time pad again to lock in the set time.
- 4) Next, press the Bake OR Broil Hi/Lo pad.
 - a. If the Bake pad has been pressed, press the + or pad to adjust to the desired oven temperature.
 - b. If the Broil Hi/Lo pad has been pressed, the HI will automatically appear on display. Press the Broil Hi/Lo pad twice to set the LO.
- 5) Next, press the Start pad to begin the delay time and the set time will appear on the display indicating that your Delay Time mode has been started.
- 6) When your delay time has been programmed, the Automatic Oven indicator will light up.
- 7) If you would like to cancel the Delay Time function, press the Cancel/Off pad

LOCK CONTROLS

The Lock Controls function locks the control panel pads from being used to avoid any unintended use of the cook functions. When the control panel is locked, only the Oven Light will function.

To Lock/Unlock Control Panel:

1. To lock the control panel, press both the + and pads at the same time and hold for three seconds, then LOC icon will appear on the display and begin to flash. Once LOC stops flashing, your control panel is now locked.
2. To unlock the control panel, press both the + and pads at the same time and hold for three seconds, then OPN icon will appear on the display and begin to flash. Once OPN icon stops flashing, your control panel is now unlocked.

▲WARNING:

LOCK CONTROLS

LOCK CONTROLS FUNCTION DOES NOT LOCK THE OVEN DOOR.

OVEN USE

IMPORTANT: To avoid permanent damage to the porcelain finish, do not place food or bakeware directly on the oven door or bottom. Do not line the oven bottom or racks with foil or liner.

NOTE: To avoid damage to the Oven Shelves surface, do not use steel-wool pads, steel wool, abrasive powder cleaners, abrasive paper towels, gritty washcloths, rust remover or harsh chemicals for cleaning.

POSITIONING RACKS AND BAKEWARE

Position racks before turning on the oven.

Do not position racks with bakeware on them.

Make sure racks are level.

To Remove Oven Racks:

Pull rack out to the stop position, raise the front edge, and then lift out.

To Replace Oven Racks:

Place rack on the rack support in the oven. Tilt the front edge up slightly, and slide rack back until it clears the stop position. Lower front and slide back into the oven.

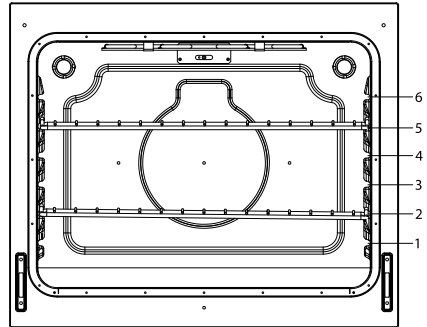

OVEN FUNCTION	RACK POSITION
BAKING	
Large Roast/Turkey	Use Rack 1
Meat/Poultry	Use Rack 2
Cake/Cookies	Use Rack 3
Batch Baking	Use Rack 2 and 5

For best results when baking layer cakes on 2 racks, use racks 2 and 5 in the lower and upper section of the oven. For an even bake, stagger the cake pans on the bottom rack so that it is not positioned directly below the pans on the top rack. Place the cake pans on the racks as shown in the illustration below. (Diagram A)

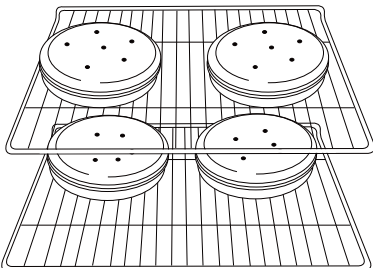

For best results when baking layer cakes on 2 racks in the middle section of the oven, use racks 3 and 5. For an even bake, stagger the cake pans on the bottom rack so that it is not positioned directly below the cake pans on the top rack. Place the cake pans on the racks as shown in the illustration below. (Diagram B)

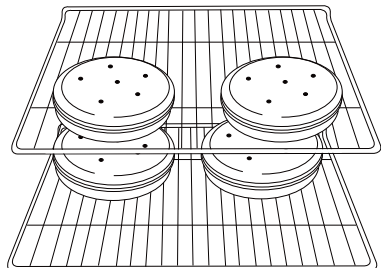

OVEN USE (continued)

NOTES:

Please wear an oven mitt when touching the oven racks or placing food in/removing food from the oven!

During cooking, if you want to change the temperature, you must first press the Cancel/ Off pad then repeat the setting steps to reset the temperature.

PRE-HEATING THE OVEN

To begin pre-heating the oven, press the Bake pad, and then press the Start pad. PrE icon will appear on the display when the oven is pre-heating and it will sound 3 reminder tones when the preheat is done.

The oven will take approximately 11 to 15 minutes to reach 350°F (177°C) with all of the oven racks provided with your oven inside the oven cavity. Higher temperatures will take longer to preheat.

The preheat cycle rapidly increases the oven temperature. The actual oven temperature will go above your set temperature to offset the heat lost when your oven door is opened to insert food. This ensures that when you place your food in the oven, the oven will begin at the proper temperature. Insert your food when the preheat tone sounds.

Do not open the door during preheat before the tone sounds.

BAKE

Before baking, position racks according to the Positioning Racks and Bakeware section.

How To Set Oven To Bake Function:

- 1) To set the oven to Bake mode, press the Bake pad on the control panel.
- 2) 350°F (177°C) will appear on the display.
- 3) Use the + or pad to enter the desired oven temperature
The temperature of the oven can be set from 170°F (77°C) to 550°F (288°C)
- 4) Once the oven temperature has been set, press the Start pad to begin the Bake, PrE icon will appear on the display indicating to begin the oven heating process.
- 5) Once the oven has reached the specified temperature, the set temperature will appear on the display, place your food in the oven when 3 reminder tones sound.
- 6) When you are finished using the oven, press the Cancel Off pad to turn off the oven.
- 7) Remove food from the oven.

BROIL

Broiling uses direct radiant heat to cook food. The lower the temperature, the slower the cooking. Thicker cuts and unevenly shaped pieces of meat, fish and poultry may cook better at lower broiling temperatures.

HOW TO SET THE OVEN TO BROIL FUNCTION:

High Setting:

- 1) To set the Broiler, press the Broil Hi/Lo pad on the control panel.
- 2) Next, press the Start pad. The display will show HI and is set to the highest temperature setting of 550°F.

Low Setting:

- 1) To set the Broiler on low, press the Broil Hi/Lo pad twice on the control panel.
- 2) Next, press the Start pad. The display will show LO and is set to the lowest temperature setting of 450°F.

OVEN USE (continued)

Once the HI Or LO Broiler Setting is Selected, you can now use the broiler

- 1) The oven has reached the specified temperature when 3 reminder tones sound, open the oven door and pull the rack out to the stop position.
- 2) Place food on a broiler safe pan, then place it in the center of the oven rack.
- 3) Push the oven rack to the original position. Close the door to ensure the proper broiler temperature.
- 4) Press the Cancel/Off pad when finished using the broiler.

COOK TIME

The cook time function is available in the Bake or Broil Hi/Lo mode.

HOW TO SET THE COOK TIME FUNCTION

- 1) When you're cooking with Bake OR Broil Hi/Lo, if a set cooking time is desired, press the Cook Time pad.
- 2) Use the + or - pad to enter the desired cooking time.
- 3) Once you have set your cooking time, press the Cook Time pad again to begin the set cooking time, and the Automatic Oven indicator will light up.
- 5) At the end of the set time, the oven will automatically turn off, and the OFF icon appear on the display and begin to flash and the end of cycle tone will sound. You can press any pad on the control panel to stop the OFF icon.

*NOTE: If you would like to set a cooking time first, press the Cook Time pad, and use the + or - pad to enter the desired cooking time, then press the Cook Time pad again to begin the set cooking time. Next, select to press the Bake or Broil Hi/Lo pad, and use the + or - pad to adjust to the desired oven temperature, then press the Start pad to begin the oven heating process to cooking, and the Automatic Oven indicator will light up. At the end of the set time, same as step 5 above.

FOOD SAFETY

Cook food thoroughly to help protect against any food borne illnesses. Use a food thermometer to take food temperatures and check in different locations.

▲WARNING:	FOOD POISONING HAZARD
DO NOT LET FOOD SIT IN THE OVEN MORE THAN ONE HOUR BEFORE OR AFTER COOKING. DOING SO CAN RESULT IN FOOD POISONING OR SICKNESS.	

OVEN CARE

▲WARNING:

TO AVOID OVEN DOOR GLASS BREAKAGE:

Do not close the oven door if the racks are not fully inserted into the oven cavity or when bakeware extends past the front edge of an oven rack.

Do not set objects on the glass surface of the oven door.

Do not hit glass surfaces with bakeware or other objects.

Do not wipe down glass surfaces until the oven has completely cooled.

For normal oven use, it is not suggested to remove the oven door. However, if removal is necessary, make sure the oven is off and cool. Then, follow the instructions below. The oven door is heavy.

▲WARNING:

TIP OVER HAZARD

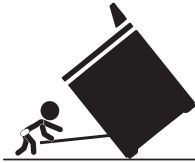

A child or adult can tip the range and be killed. Make sure the anti-tip bracket has been properly installed and secured per the installation instructions. Re-secure the anti-tip bracket if range is moved. Do not operate the range without the anti-tip bracket installed and secured. Failure to follow these instructions can result in death or serious burns to adults and children.

OVEN DOOR

IMPORTANT: Use both hands to remove oven door(s).

1. Open the oven door fully so it is at a 90 degree angle.
2. Next, locate the the oven door latches in both corners of the oven door, then flip up the hinge latch on each side to the unlocked position. (See diagram below). Pliers may be required to unlock hinges.
3. Once the latch is in the unlocked position, grasp the oven door with both hands, and then gently close the oven door to as far as it will shut.
4. Using both hands, lift and pull the oven door towards you and remove.
5. Set the oven door(s) aside on a covered work surface.

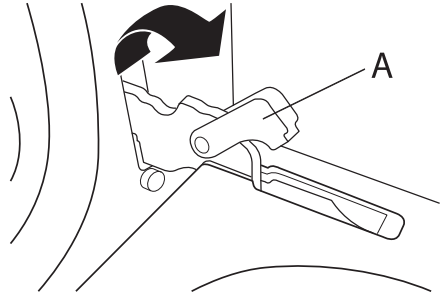

OVEN CARE (continued)

HOW TO REINSTALL THE OVEN DOOR

1. To reinstall the oven door, insert both hanger arms of the oven door into the range. The hinge latches on both sides should be in the unlocked position before inserting hanger arms into the range.
2. Once the hanger arms are placed into the range, open the oven door fully. It is recommended to use a rubber mallet to ensure hinges are securely locked into place.
3. Next, locate the hinge lever latches, and move them back to the locked position.
4. Once the oven door levers are locked, gently close the door and check that the door can open and close with no issues.
5. Check to see if there are any gaps on both sides of the oven door. If there are gaps, the door has not been reinstalled correctly. Repeat the removal and installation procedure.

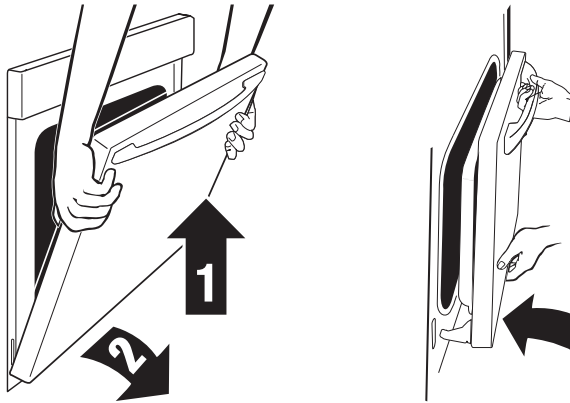

OVEN GASKET

The gasket is essential for a good seal. Care should be taken not to rub, damage, or move the gasket.

▲WARNING:

CHOKING HAZARD

SMALL PARTS. NOT FOR CHILDREN UNDER 3 YEARS OLD.

OVEN LIGHT

The oven's light is a standard 25-watt (G9 Halogen) appliance bulb. Before replacing, make sure the oven and cooktop are cool and the control knobs are off.

HOW TO REPLACE OVEN LIGHT

1. Disconnect the power supply.
2. Turn the glass cover counter clockwise to remove.
3. Pull out the bulb straight out of the socket.
4. Replace bulb by pushing in, then reinsert glass cover clockwise
5. Reconnect power.

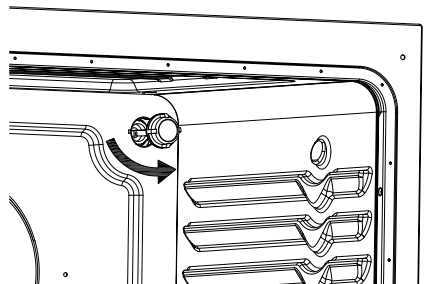

OVEN CARE (continued)

CERAMIC GLASS COOKTOP CLEANING

To avoid damaging the cooktop, do not use steel wool, abrasive powder cleansers, chlorine bleach, rust remover or ammonia.

1. Remove food/residue with a cooktop scraper.

For best results, use the cooktop scraper while the cooktop is still warm, but not hot to the touch.

It is recommended to wear an oven mitt while scraping the warm cooktop.

Hold the cooktop scraper at approximately a 45° angle against the glass surface and scrape the residue. It will be necessary to apply pressure to remove the residue.

Allow the cooktop to cool down completely before proceeding to Step 2.

2. Apply a few dime-sized drops of cooktop cleaner to the affected areas.

Rub cooktop cleaner onto the cooktop surface with a cooktop cleaning pad.

Some pressure is needed to remove stubborn stains.

Allow the cleaner to dry to a white haze before proceeding to Step 3.

3. Gently rub surface to remove dried cooktop cleaner with a non-abrasive cleaning pad.

Then wipe cooktop surface with a clean damp cloth.

Dry with a clean dry cloth or paper towel

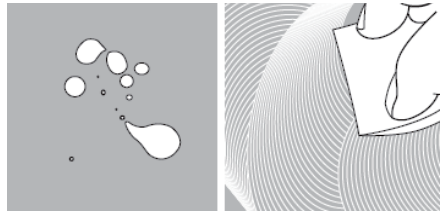
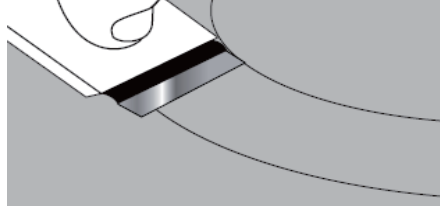

OVEN CARE (continued)

GENERAL CLEANING

IMPORTANT: Before cleaning, make sure all controls are off and the oven is cool. Always follow label instructions on cleaning products.

Use soap and water along with a soft cloth or sponge to clean the surface areas of the range. Wipe with a clean damp cloth, then wipe dry.

To clean control panel and knobs, wipe surfaces with soapy soft cloth, then wipe down with cloth rinsed in water. Dry with clean, soft cloth.

 WARNING:	STAINLESS STEEL (ON SOME MODELS)
	TO AVOID DAMAGE TO STAINLESS STEEL SURFACES, DO NOT USE SOAP-FILLED SCOURING PADS, ABRASIVE CLEANERS, COOKTOP CLEANER, STEEL-WOOL PADS, GRITTY WASH-CLOTHS OR ABRASIVE PAPER TOWELS.

CLEANING METHOD FOR STAINLESS STEEL

Use a stainless-steel cleaner, or a mild cleaner recommended on stainless steel surfaces.

Wipe cleaner with a soft cloth in the direction of the grain to avoid damage.

Rinse with clean water and dry with soft, lint-free cloth.

May use stainless steel polish for appliances afterwards

CLEANING THE OVEN DOOR EXTERIOR

Clean with a mild soap and warm water.

Rinse with clean water, then dry with a soft cloth.

CLEANING THE OVEN CAVITY

Do not use strong oven cleaners as they may scratch the interior coating.

Food spills should be cleaned when oven cools. At high temperatures, foods may react with the porcelain coating resulting in staining, etching, pitting or faint white spots.

Do not use a steel-wool pad to clean inside surfaces.

Use a non-scratch sponge to scrub tough surfaces areas.

Clean interior areas with a mild soap and warm water.

Rinse with a clean damp cloth, then dry with a soft cloth.

TROUBLESHOOTING TIPS

Try the solutions suggested here first to avoid the cost of an unnecessary service call.

OVEN WILL NOT OPERATE	POSSIBLE SOLUTIONS
Has a household fuse blown, or has a circuit breaker tripped?	Replace the fuse or reset the circuit breaker. If the problem continues, call an electrician.
Is the Electronic Oven Control set correctly?	See Electronic Oven Controls section.
Display shows E02	Temperature sensor error. Call Customer Service.
Display shows E03	High temperature warning. Oven function will shut off automatically. Allow oven to cool for 30 minutes and resume using oven functions. If error continues to occur call Customer Service.
Is the Oven Control Lockout set?	See Control Lockout section.
OVEN TEMPERATURE TOO HIGH OR TOO LOW	
Does the Oven Temperature Calibration need adjustment?	See Oven Temperature Control section.
Do the Oven Indicator Lights flash?	See the Display and/or the Oven Lights section. If the indicator light(s) keeps flashing, call for service. See Assistance or Service section.
OVEN COOKING RESULTS NOT WHAT EXPECTED	
Is the proper oven temperature calibration set?	See Oven Temperature Control section.
Was the Oven preheated?	See Baking section.
Are the racks positioned properly?	See Positioning Racks and Bakeware section.
Is there proper air circulation around bakeware?	See Positioning Racks and Bakeware section.
Is the batter evenly distributed in the pan?	Check that batter is level in the pan.
Is the proper length of time being used?	Adjust cooking time.
Has the oven door been opened while cooking?	Oven peeking releases oven heat and can result in longer cooking times.
Are baked items too brown on the bottom?	Move rack to higher position in the oven.
Are pie crust edges browning early?	Use aluminum foil to cover the edge of the crust and/or reduce backing temperature.

LIMITED WARRANTY

Element Appliance Limited Warranty

(the “Products” or “Product” when referencing a singular product herein)

This Product (including any accessories included in the original packaging) as supplied and distributed in new condition, is warranted by Element Appliance Company, LLC (“Element”) to the original customer who purchases the Product from an authorized Element retailer (the “Original Customer” or “you”) against defects in material and workmanship under proper use, maintenance, and care according to the owner’s manual, warnings, and instructions accompanying the Product (“Warranty”) as follows:

* **PLEASE NOTE** – Proof of purchase evidencing the date of purchase by the Original Purchaser from an authorized Element retailer (“Valid Proof of Purchase”) is **required** for all Warranty service. The express Warranty set forth herein is subject to all terms and conditions set forth below.

1. WARRANTY SERVICE:

A. ONE-YEAR WARRANTY: Except as provided in subpart 1.B below, for a period of **one (1) year** from the date of purchase by the Original Customer (the “Warranty Period”), if the parts or components covered by this Warranty are determined by Element or Element’s authorized service provider to be defective in material or workmanship, Element will, at its sole and absolute discretion and option: (i) repair the defective part or component at no charge to the Original Customer, (ii) replace the defective Product with a new Product of similar or better quality, at no charge to the Original Customer, or (iii) refund the documented purchase price paid by the Original Customer (excluding tax) to the Original Customer upon return of the defective Product as directed by Element. After the Warranty Period expires, the Original Customer must pay for all parts, components, shipping and handling, labor, and replacement costs associated with the Product or any part or component thereof, regardless of any defects in the Product or any part or component thereof.

B. LIMITED EXTENDED WARRANTY THROUGH PRODUCT REGISTRATION: If and only if the Original Customer registers the Product at www.elementelectronics.com within **ninety (90)** days of the date of purchase by the Original Customer, then the Warranty Period discussed in subpart 1.A. above shall be extended an additional one (1) year to a new Warranty Period equaling **two (2) years** from the date of purchase by the Original Customer. If the Product is not registered as provided for in this subpart 1.B, then the standard one-year Warranty Period set forth in subpart 1.A shall apply.

C. TIMING AND PROCEDURE: Before Warranty service can commence, the Original Customer must contact either (i) the retailer from whom the Original Customer purchased the Product, or (ii) Element directly, in either case for problem determination and service procedures. Valid Proof of Purchase evidencing that the Product is within the Warranty Period **MUST** be presented by Original Customer in order to obtain the requested Warranty service. Please have your model and serial number available, along with your date of purchase of the Product. To remain eligible for Warranty service, Original Customer may not return the Product or any part or component thereof to the retailer or Element without Element’s prior written consent.

LIMITED WARRANTY

2. EXCLUSIONS AND LIMITATIONS TO WARRANTY SERVICE

The Warranty covers manufacturing defects in materials and workmanship of the Product encountered in the normal, non-commercial use of the Product, and **does not cover** (a) damages or malfunctions resulting from improper or unreasonable use or maintenance, abuse, negligence, failure to follow instructions contained in any written materials that accompany the Product, deterioration by reason of excess moisture, corrosive atmosphere, lightning, power surges, connections to improper voltage supply, unauthorized alteration, or other external causes such as extremes in temperature or humidity, modifications, scratches or discoloration; (b) any damage caused by using non-authorized parts or service facilities for repair of Products (however, for avoidance of doubt, using non-authorized parts or service facilities will not, in and of itself, void the Warranty); (c) transportation, shipping, delivery, pickup, insurance, installation, or set-up costs; (d) ordinary wear and tear, cosmetic damage, or damage due to acts of nature, including but not limited to, water, floods, wind, storm, tornado, earthquake, or fire, or due to damage caused by extraordinary impact events, such as dropping, crushing, demolition or other extraordinary damage; (e) commercial use of the Product, or use of the Product for anything other than single-family household or residential use; or (f) modification of the Product or any part of the Product.

This Warranty is made to the Original Customer only and does not cover Products sold AS IS or WITH ALL FAULTS. The Warranty is invalid if the factory-applied serial number has been altered or removed from the Product. This Warranty is valid only in the United States, and only applies to Product if it was purchased and serviced in the United States. The addition of equipment or features to the Product that are not manufactured or recommended by Element could affect the intended function of the Product, and therefore may void the Warranty. Furthermore, the exposure of the Product to chemicals, heat, cold, humidity, or other elements can affect the Product components, and therefore, the Warranty does not cover discoloration, fading, cosmetic changes, rust, or any damages or failure related to any such items. The Warranty is contingent upon the proper use, maintenance, and care of the Product. The Warranty may be void if the Product has been used in a manner contradictory to, or in violation of, the terms of the user's manual, warnings, or instructions accompanying the Product.

THIS WARRANTY IS MADE IN LIEU OF AND SUPERSEDES ALL OTHER WARRANTIES OR CONDITIONS OF MERCHANTABILITY OR FITNESS FOR A PARTICULAR PURPOSE OR GENERAL USE, WHETHER EXPRESS, IMPLIED, COLLATERAL, STATUTORY, OR PROVIDED BY COMMON LAW, THE UNIFORM COMMERCIAL CODE, OR OTHERWISE. ELEMENT FURTHER DISCLAIMS ALL WARRANTIES AFTER THE END OF THE WARRANTY TERM DEFINED ABOVE.

LIMITED WARRANTY

NO OTHER EXPRESS WARRANTY OR GUARANTY GIVEN BY ANY OTHER PERSON, FIRM, OR ENTITY WITH RESPECT TO THE PRODUCT SHALL BE BINDING ON ELEMENT. REPAIR, REPLACEMENT, OR REFUND OF THE ORIGINAL PURCHASE PRICE, AT ELEMENT'S SOLE DISCRETION, ARE THE EXCLUSIVE REMEDIES OF THE CUSTOMER.

ELEMENT SHALL NOT BE LIABLE FOR ANY INCIDENTAL OR CONSEQUENTIAL DAMAGES CAUSED BY THE USE, MISUSE, OR INABILITY TO USE THE PRODUCT. THESE INCLUDE, BUT ARE NOT LIMITED TO, ANY DAMAGES IN THE FORM OF LOST PROFITS, LOSS OF USE, LEGAL FEES, ECONOMIC LOSS, PERSONAL INJURIES, OR ANY OTHER DAMAGES CAUSED BY CIRCUMSTANCES BEYOND THE CONTROL OF ELEMENT. NOTWITHSTANDING THE FOREGOING, ELEMENT'S AGGREGATE LIABILITY TO ANY CUSTOMER SHALL NOT EXCEED THE ORIGINAL PURCHASE PRICE OF THE PRODUCT. THIS WARRANTY SHALL NOT EXTEND TO ANYONE OTHER THAN THE ORIGINAL CUSTOMER WHO PURCHASED THE PRODUCT, AND IS NOT TRANSFERRABLE. NO PERSON IS AUTHORIZED TO ALTER, EXTEND, OR WAIVE THIS WARRANTY OR ANY OF ITS TERMS OR CONDITIONS.

Some states do not allow the exclusion or limitation of incidental or consequential damages, or allow limitations on warranties, so the above limitations or exclusions may not apply to you. This Warranty gives you specific rights, and you may have other rights, which vary from state to state. The exclusions and limitations to the Warranty apply to the maximum extent permitted by law and unless restricted or prohibited by law. Where any term of this Warranty is prohibited by applicable law, it shall be null and void, but the remainder of this Warranty shall remain in effect. PLEASE DIRECT ALL CORRESPONDENCE TO:

Element Appliance Company, LLC
customerservice@elementelectronics.com
(888) 842-3577
<https://elementelectronics.com>

NOTES



30" Standard Electric Range User Manual

Element, the Element Logo, and Bring it home are trademarks of Element Brand Holding, LLC. All other trademarks are the property of their respective owner, who has not sponsored, endorsed, or approved this product. ©2024 Element Appliance Company, LLC. All rights reserved.

Distributed by Element Appliance Company, LLC
Augusta, GA 30909

For service, support and warranty information:
Call 888.842.3577, email us at
customerservice@elementelectronics.com
or visit www.elementelectronics.com

EER34MSCW/EER34MSCS/EER34MSCB