

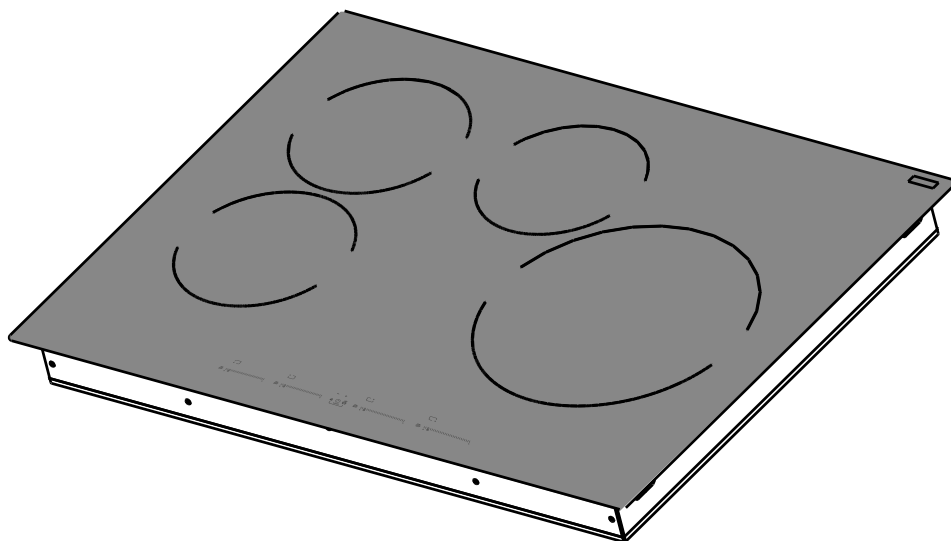

Use, care, and
installation guide

Guide
d'utilisation,
d'entretien et
d'installation

Guía de
instalación, uso y
mantenimiento

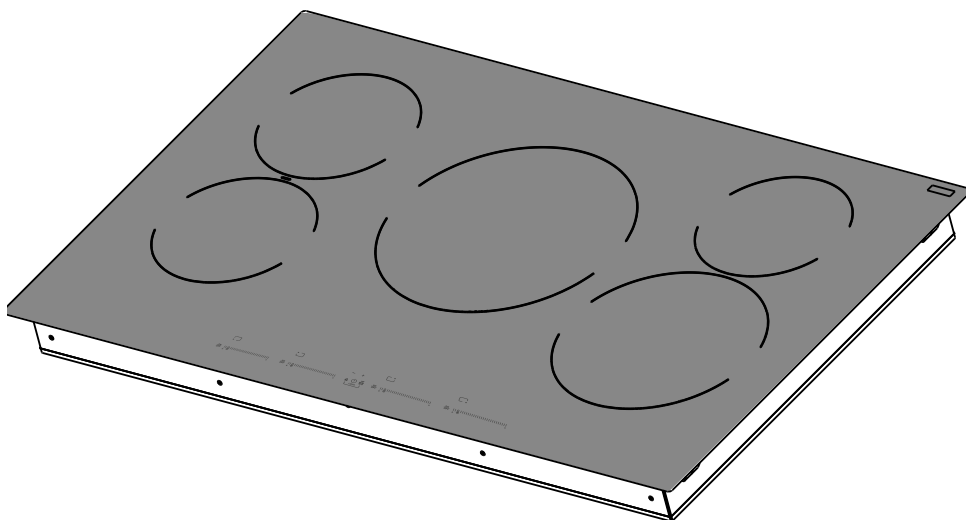

READ AND SAVE THESE
INSTRUCTIONS

LISEZ CES
INSTRUCTIONS ET
CONSERVEZ-LES

LEA Y CONSERVE
ESTAS INSTRUCCIONES

Models: | EIV430BL
EIV536BL

LIB0190446A
Printed in Mexico

Contents

Important safety notice3
 Electrical & installation requirements.....5
 List of materials 6
 Cutout 6
 Product dimensions 7
 Installation 8
 Description of the hood & controls.....10
 Use 11
 Power tables 13
 Cooking tables 14
 Electrical diagram 15
 User servicing & maintenance intructions16
 Troubleshooting..... 16
 Warranty17

READ AND SAVE THESE INSTRUCTIONS

We have provided many important safety messages in this manual and on your appliance. Always read and obey all safety messages.



This is the safety alert symbol.
 This symbol alerts you to potential hazards that can kill or hurt you and others.
 All safety messages will follow the safety alert symbol and either the word “DANGER” or “WARNING.”
 These words mean:

 DANGER

You can be killed or seriously injured if you don't immediately follow instructions.

 WARNING

You can be killed or seriously injured if you don't follow instructions.

All safety messages will tell you what the potential hazard is, tell you how to reduce the chance of injury and tell you what can happen if the instructions are not followed.

⚠ Important Safety Notice

⚠ WARNING

To reduce the risk of fire, electrical shock, injury to persons, or damage when using the cooktop, follow basic precautions, including the following:

⚠ CAUTION

- Do not store items of interest to children in cabinets above a cooktop – **Children climbing on the cooktop could be seriously injured.**
- **Proper Installation** – Be sure your cooktop is properly installed and grounded by a qualified technician.
- Never use your cooktop for warming the room.
- **Do not leave children alone** – Children should not be left alone or unattended in area where cooktop is in use. They should never be allowed to sit or stand on any part of the cooktop.
- **Wear proper apparel** – Loose-fitting or hanging garments should never be worn while using the cooktop.
- **User servicing** – Do not repair or replace any part of the cooktop unless specifically recommended in the manual. All other servicing should be referred to a qualified technician.
- **Storage on cooktop** – Flammable materials should not be stored near surface units.
- **Do not use water on grease fires** – Smother fire or flame or use dry chemical or foam-type extinguisher.
- **Use only dry potholders** – Moist or damp potholders on hot surfaces may result in burns from steam. Do not let potholder touch hot heating elements. Do not use a towel or other bulky cloth.
- **DO NOT TOUCH SURFACE UNITS OR AREAS NEAR UNITS** – Surface units may be hot even though they are dark in color. Areas near surface units may become hot enough to cause burns.

During and after use, do not touch, or let clothing or other flammable materials contact surface units or areas near units until they have had sufficient time to cool. Among those areas are the cooktop and surfaces facing the cooktop.

- **Use proper pan size** – This cooktop is equipped with one or more surface units of different size. Select utensils having flat bottoms large enough to cover the surface unit heating element. Proper relationship of utensil to burner will also improve efficiency.
- **Never leave surface units unattended at high heat settings** – Boilover causes smoking and greasy spillovers that may ignite.
- **Glazed cooking utensils** – Only certain types of glass, glass/ceramic, ceramic, earthenware, or other glazed utensils are suitable for cooktop service without breaking due to the sudden change in temperature.
- Utensil handles should be turned inward and not extend over adjacent surface units

- To reduce the risk of burns, ignition of flammable materials, and spillage due to unintentional contact with the utensil, the handle of a utensil should be positioned so that it is turned inward, and does not extend over adjacent surface units.
- **Do not cook on broken cooktop** – If cooktop should break, cleaning solutions and spillovers may penetrate the broken cooktop and create a risk of electric shock. Contact a qualified technician immediately.
- **Clean cooktop with caution** – If a wet sponge or cloth is used to wipe spills on a hot cooking area, be careful to avoid steam burn. Some cleaners can produce noxious fumes if applied to a hot surface.
- **Do not place metal objects such as knives, forks, spoons and lids on the hob surface as they may overheat.**

FOR UNITS WITH COIL ELEMENTS

- **Make sure reflector pans or drip bowls are in place** – Absence of these pans or bowls during cooking may subject wiring or components underneath to damage
- **Protective liners** – Do not use aluminum foil to line surface unit drip bowls, except as suggested in the manual. Improper installation of these liners may result in a risk of electric shock, or fire.
- **Do not soak removable heating elements** – Heating elements should never be immersed in water.

This induction cooktop generates and uses ISM frequency energy that heats cookware by using an electromagnetic field. It has been tested and complies with Part 18 of the FCC Rules for ISM equipment. This induction cooktop meets the FCC requirements to minimize interference with other devices in residential installation.

This induction cooktop may cause interference with television or radio reception. If interference occurs, the user should try to correct the interference by:

- Relocating the receiving antenna of the radio or television.
- Increasing the distance between the cooktop and the receiver.
- Connecting the receiver into a different outlet.

It is the user's responsibility to correct any interference.

NOTE: People with a pacemaker or similar medical device should use care when standing near this induction cooktop while it is on. The electromagnetic field may affect the pacemaker or similar device. Consult your doctor or the manufacturer of the pacemaker or similar medical device for additional information about its effects with electromagnetic fields of the induction cooktop.

⚠CAUTION

Strictly observe the following instructions:

- The device must be disconnected from the electrical network before performing any installation work.
- Installation or maintenance must be performed by a qualified technician, in compliance with the manufacturer's instructions and with local safety regulations. Do not repair or replace any part of the device unless specifically stated in the operating manual.
- Earthing the device is compulsory.
- Do not use multiple sockets or extension cords.
- Once installation is complete, the electrical components must no longer be accessible by the user.
- The device and its accessible parts heat up during use.
- Be careful not to touch the heating elements.
- Ensure that children do not play with the device; keep children away and supervise them, as the accessible parts may become very hot during use.
- For people with pacemakers and active implants it is important to check, prior to using the induction hob, that their pacemaker is compatible with the device.
- During and after use, do not touch the heating elements of the device.
- Avoid contact with cloths or other flammable materials until all the device components have sufficiently cooled.
- Do not place flammable materials on or near the device.
- Overheated fats and oils easily catch fire. Supervise the cooking of foods rich in fat and oil.
- If the surface is cracked, switch off the device to avoid the possibility of an electric shock.
- The device is not intended to be run with an external timer or a separate remote control system.
- Unattended cooking on a hob with oil or fat may be dangerous and may cause a fire.
- The cooking process must be supervised. A short-term cooking process must be constantly monitored.
- NEVER attempt to put fires out using water. Instead, turn off the device and smother the flames, for example with a lid or a fire blanket. Fire hazard: do not rest objects on the cooking surfaces.
- Do not use steam cleaners.
- Before connecting the device to the electrical network: check the data plate (on the bottom of the device) to ensure that the voltage and power correspond to the network values and that the connection socket is suitable. If in doubt, consult a qualified electrician.

⚠IMPORTANT

- After use, turn off the cooktop and do not rely on the pan detector.
- Prevent liquids from boiling over, so turn the heat down when boiling or heating liquids.
- Do not leave the heating elements turned on with empty pots and pans or with no pans.
- Switch off the relevant hot plate when you have finished cooking.
- Never use aluminium foil for cooking and never place products packaged in aluminium on the hob. The aluminium would melt and irreparably damage your device.

- Never heat a tin or can containing foods without opening it first: it might explode!
- This warning also applies to all other types of cook-tops.
- High power levels such as the Booster function should not be used to heat certain liquids, such as oil for frying. Excessive heat may be dangerous. In these cases, we recommend the use of a lower power level.
- Containers must be placed directly on the hob center. Under no circumstances may any other objects be placed between the pan and the hob.
- If the temperature becomes high, the device automatically decreases the power level of the cooking zones.
- Before doing any cleaning or maintenance work, disconnect the device from the mains power supply by removing the plug or turning off the mains switch
- Wear protective gloves for all installation and maintenance operations.
- The device can be used by children over the age of eight and by people with impaired physical, sensory or mental abilities or lacking in experience or the necessary knowledge provided that they are supervised or after they have received instruction about how to safely use the device and understand the inherent dangers.
- Cleaning and maintenance must never be performed by children unless they are properly supervised. The room must be properly ventilated when the device is used at the same time as other gas-powered devices, or powered by other fuel.

The device must be regularly cleaned both internally and externally (AT LEAST ONCE A MONTH), in strict accordance with the maintenance instructions. Failure to follow the rules for device cleaning and filter replacement and cleaning may result in a fire hazard. Food must never be cooked flambè. Using a naked flame may damage the filters and cause a fire hazard; it must, therefore, be avoided under all circumstances. Extra care must be taken when frying to prevent the oil from overheating and catching fire.

PLEASE NOTE:

- The accessible parts of the device may become hot when hob is switched on.
- Do not connect the device to the electric power supply until installation has been fully completed. The regulations laid down by local authorities must be strictly followed with regard to the technical and safety measures to adopt for fume extraction.
- When the device is used together with other devices powered with non-electrical energy, the negative pressure of the room must not exceed 4 Pa (4 x 10⁻⁵ bar).
- This manual must be stored for future consultation at any time. If sold, transferred or moved, it must remain with the device.

ELECTRICAL & INSTALLATION REQUIREMENTS

ELECTRICAL REQUIREMENTS

240 V 2 wire 60Hz

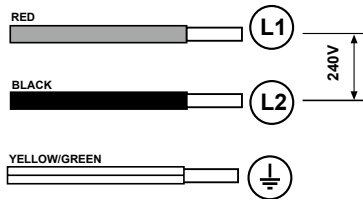

- Disconnect the cooktop from the electrical network.
- The installation must be performed by professionally qualified personnel familiar with the applicable installation and safety standards.
- The manufacturer declines any liability to people, animals or things in the case of failure to follow the guidelines provided in this chapter.
- Make sure that the voltage on the rating plate on the bottom of the device corresponds to that of the house where it will be installed.
- Do not use extension cords.
- Earthing is required by law.

⚠️IMPORTANT

Observe all governing codes and ordinances.

It is the customer's responsibility:

- To contact a qualified electrical installer.
- To assure that the electrical installation is adequate and in conformance with National Electrical Code, ANSI/NFPA 70 — latest edition*, or CSA Standards C22.1-94, Canadian Electrical Code, Part 1 and C22.2 No.0-M91 latest edition** and all local codes and ordinances.
- If codes permit and a separate ground wire is used, it is recommended that a qualified electrician determine that the ground path is adequate.
- Do not ground to a gas pipe.
- Check with a qualified electrician if you are not sure cooktop is properly grounded.
- Do not have a fuse in the neutral or ground circuit.

⚠️CAUTION

Risk of Electric Shock, frame grounded to neutral of appliance through a link. Grounding through the neutral conductor is prohibited for new branch-circuit installations (1996 NEC); mobile homes; and recreational vehicles, or in an area where local codes prohibit grounding through the neutral conductor. When installed where it is not permitted to ground through the neutral, the 3-conductor cord or cable assembly must be replaced by a 4-conductor cord or cable assembly.

⚠️IMPORTANT

USE COPPER OR ALUMINIUM CONDUCTORS

⚠️IMPORTANT

- Save Installation Instructions for electrical inspector's use.
- The appliance should be connected directly to the fused disconnect (Or circuit breaker) box through metal electrical conduit.
- Wire sizes must conform to the requirements of the National Electrical Code ANSI/NFPA 70 — latest edition*, or CSA Standards C22.1-94, Canadian Electrical Code Part 1 and C22.2 No. 0-M91 - latest edition** and all local codes and ordinances.
- A U.L.- or C.S.A.-listed conduit connector must be provided at each end of the power supply conduit (at the appliance and at the junction box).
- Copies of the standards listed may be obtained from:
* National Fire Protection Association Batterymarch Park Quincy, Massachusetts 02269
** CSA International 8501 East Pleasant Valley Road Cleveland, Ohio 44131-5575



BEFORE INSTALLING

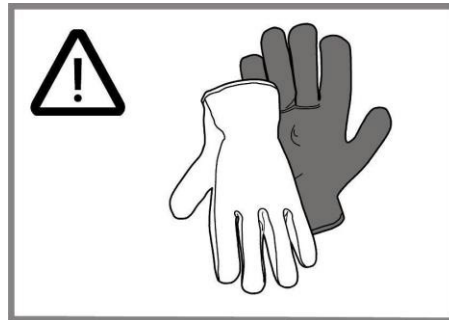



At least two people are necessary for installation. Wear gloves to protect against sharp edges.

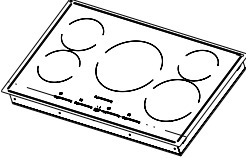

To eliminate the risk of burns or fire by reaching over heated surface units, cabinet storage space located above the surface units should be avoided.

LIST OF MATERIALS

| Supplied Part | Pieces |
|--|--------|
|  Cooktop assembly | 1 |
|  Spring for installation | 4 |

| Supplied Part | Pieces |
|--|------------------|
|  Adhesive tape for glass | 30": 1 36": 2 |
|  Spacers .5 mm | 8 |
|  Spacers 1mm | 4 |
|  Spacers 2 mm | 4 |

CUTOUT

Top Installation

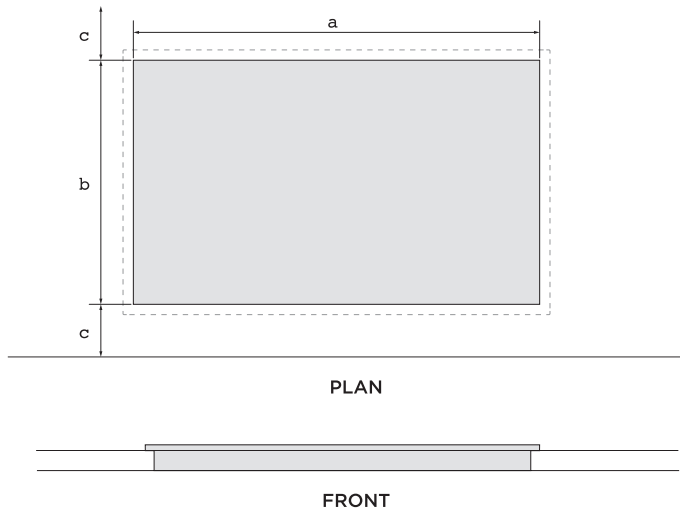

Flush Installation

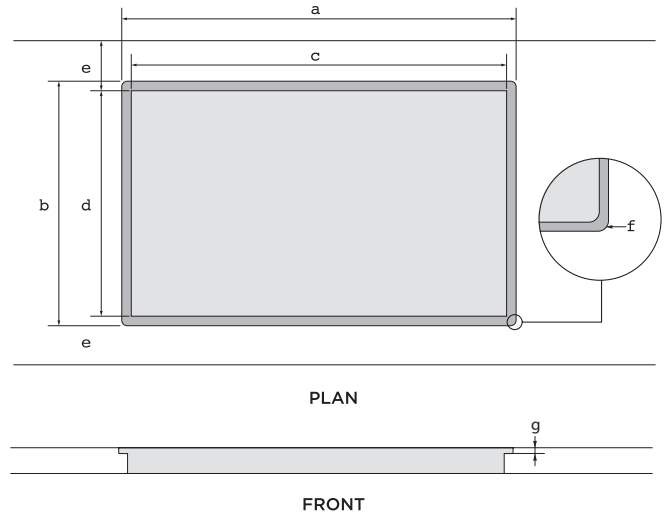

| | Model EIV430BL | Model EIV536BL |
|----------|----------------------------|---------------------|
| a | 28 7/8" (73.34 cm) | 34 9/16" (87.79 cm) |
| b | 20 1/2" (52.07 cm) | |
| c | 1 15/16" (5 cm) minimum | |

| | Model EIV430BL | Model EIV536BL |
|----------|----------------------------|---------------------|
| a | 30 7/16" (77.35 cm) | 36 1/8" (91.8 cm) |
| b | 22 1/3" (56.76 cm) | |
| c | 28 7/8" (73.34 cm) | 34 9/16" (87.79 cm) |
| d | 20 1/2" (52.07 cm) | |
| e | 1 15/16" (5 cm) minimum | |
| f | 4 x Ø 7 | |
| g | 1/4" (0.63 cm) | |

Cooling and exhausting ports shall be separated by a deflector extending from the bottom of the unit to at least 3 inches.

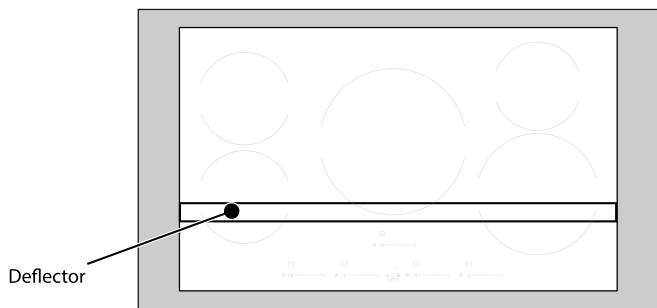

PLAN

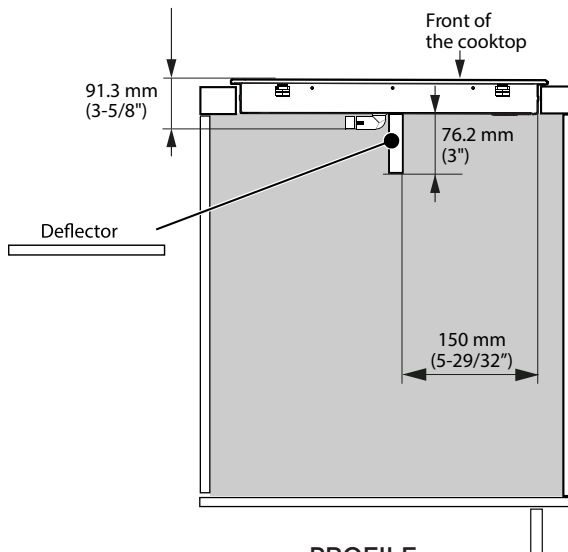

PROFILE

PRODUCT DIMENSIONS

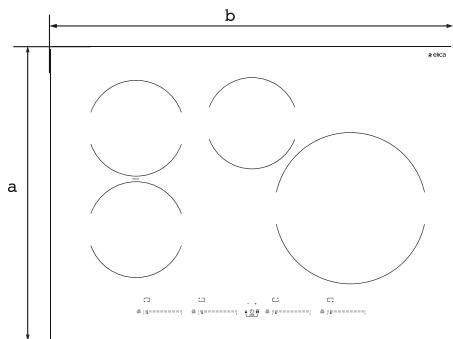

EIV430BL
PLAN

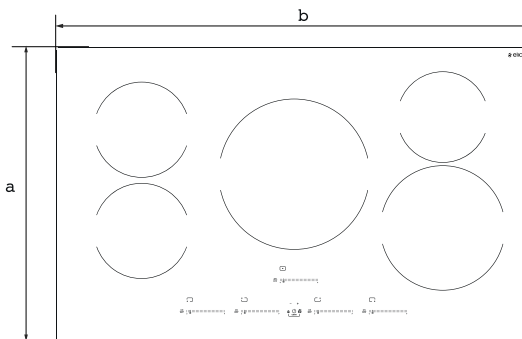

EIV536BL
PLAN

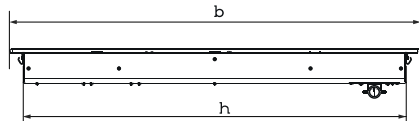

FRONT

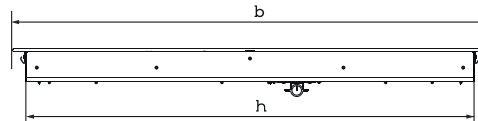

FRONT

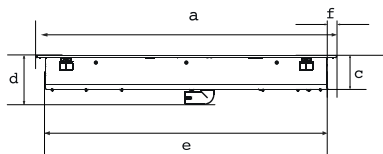

PROFILE

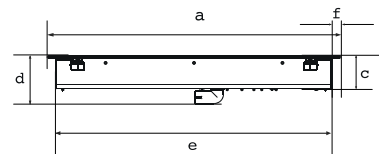

PROFILE

| | Model | Model |
|----------|--|---|
| | EIV430BL | EIV536BL |
| a | 22 ³ / ₁₆ " (56.46 cm) | |
| b | 30 ³ / ₈ " (77 cm) | 36 ¹ / ₁₆ " (91.5 cm) |
| c | 2 ¹ / ₂ " (6.2 cm) | |
| d | 3 ⁵ / ₈ " (9.13 cm) | |
| e | 20 ¹ / ₄ " (51.5 cm) | |
| f | 3 ¹ / ₃₂ " (2.45 cm) | |
| h | 28 ³ / ₈ " (71.94 cm) | 34" (86.38 cm) |

INSTALLATION

- Both electric and mechanical installation must be carried out by specialised personnel.
- The cooktop is designed to be built into a work top with a minimum thickness of 3 cm for both types of installation.
- The minimum distance between the hob and the wall must be at least 5 cm in front, at least 4 cm on the sides and at least 50 cm from overhead wall units.

NB = The recommended distances are given as examples: when planning the spaces, the indications of the kitchen manufacturer must be observed.

PREPARATION FOR INSTALLATION:

Before starting the installation:

- After unpacking the product, check that it has not been damaged during transport and in the event of problem, please contact the reseller or the customer support service before installing it.
- Check that the product is the right size for the installation area.
- Check for accessories (e.g. bags containing screws, warranty certificates, etc.) inside the packaging (placed there for transport reasons). Remove and keep them safe, if present.
- Also check that there is a power socket near the installation area.

PREPARING THE CABINET FOR INSTALLATION:

- The product cannot be installed above cooling appliances, dishwashers, heaters, ovens, washing machines and dryers.
- Create the cut-outs in the cabinet before inserting the hob and carefully remove any shavings or sawdust.

⚠ CAUTION

Failure to install screws and fasteners in accordance with these instructions may result in electrical hazards.

⚠ IMPORTANT

Use a single-component adhesive sealant (S), which withstands temperatures up to 250°; before installation, thoroughly clean the surfaces to stick and eliminate any substance that may compromise adhesion, (e.g. release agents, preservatives, fats, oil, dust, traces of old adhesives, etc.); the adhesive should be uniformly spread all around the outside of the frame; after sticking, leave the adhesive to dry for about 24 hours.

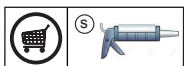
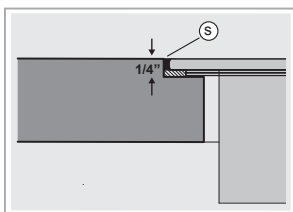

3-Wire Cable from Home Power Supply to 3-Wire Cable from Cooktop

IMPORTANT: Use the 3-wire cable from home power supply in the U.S. where local codes do not allow grounding through homes and recreational vehicles, new construction, and in Canada.

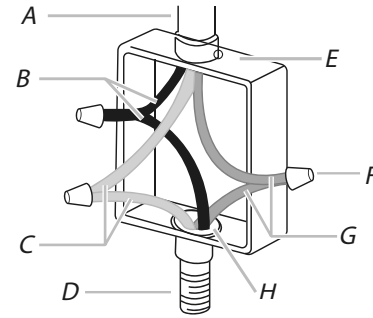

- A. Cable from home power supply
- B. Black wires (Phase)
- C. Green or yellow-green ground wires (ground)
- D. Conduit with 3-Wire from cooktop
- E. Junction box
- F. UL listed wire connector (not supplied)
- G. Red wires (Phase)
- H. UL listed or CSA approved conduit connector (not supplied).

1. Connect the 2 black wires together using the UL listed wire connectors.
2. Connect the 2 red wires together using the UL listed wire connectors.
3. Connect the green (or yellow-green) ground from the cooktop cable to the green (or yellow-green) ground wire (in the junction box) using the UL listed wire connectors.
4. Install junction box cover. 3-Wire Cable from Home Power Supply to 3-Wire Cable from Cooktop - U.S. Only.

TOP INSTALLATION

1. Turn the cooktop upside down on a protective cover.

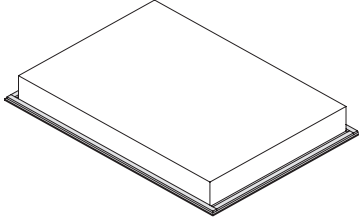

2. Apply adhesive foam seal around the glass overhang, 5mm from the edge of the glass. Ensure the adhesive side facing is down to form a continuous seal around the cooktop.

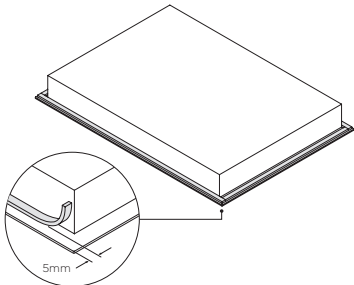

3. Trim the excess sealing material using a sharp cutter or trimmer knife. Take care not to damage the benchtop.

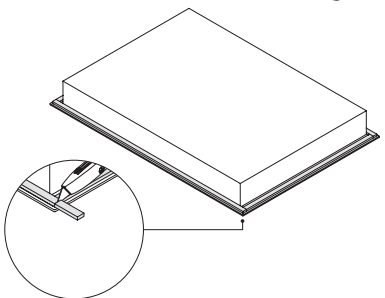

4. Attach the four side clips to the cooktop chassis. Make sure the clips are oriented correctly, press the center tab with a flat screwdriver to pass the clip through and secure against the plate.

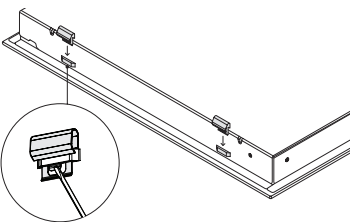

5. Lift the cooktop and place it in the center by dropping carefully both sides of the grill at the same time.
6. Clean the cooktop carefully with a cloth.

FLUSH INSTALLATION

1. Prepare the countertop for flush installation. Use a router to cutout the edges of the countertop to specified depth (.63cm). Ensure all bare edges are sealed.

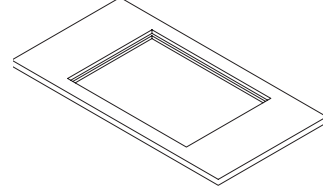

2. Turn the cooktop upside down on a protective cover & apply adhesive foam seal around the glass overhang, 5mm from the edge of the glass. Ensure the adhesive side facing is down to form a continuous seal around the cooktop.

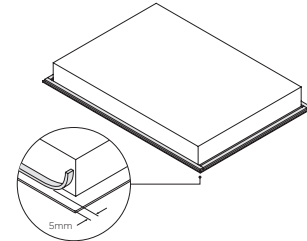

3. Trim the excess sealing material using a sharp cutter or trimmer knife. Take care not to damage the benchtop.

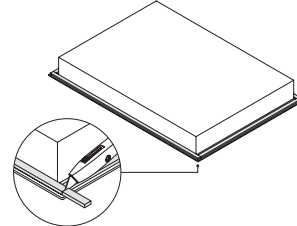

4. Attach the four side clips to the cooktop chassis. Make sure the clips are oriented correctly, press the center tab with a flat screwdriver to pass the clip through and secure against the plate.

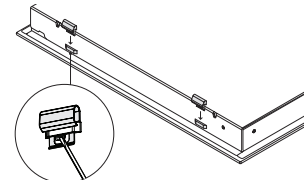

5. Lift the cooktop and place it in the center by dropping carefully both sides of the grill at the same time.
6. If necessary, spacers should be installed to adjust the height of the grill with respect to the countertop.

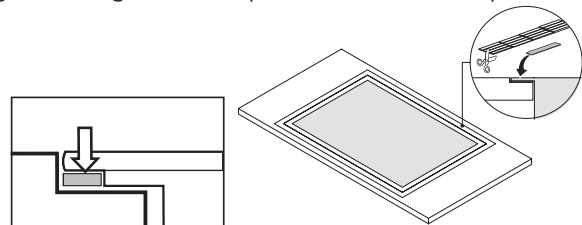

7. Apply silicone in the gap between countertop and cooktop. Wipe off any excess silicone.

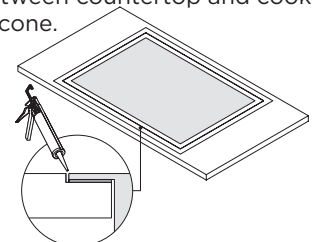

8. Clean the cooktop carefully with glass cleaner and a cloth.

DESCRIPTION OF THE HOOD AND CONTROLS

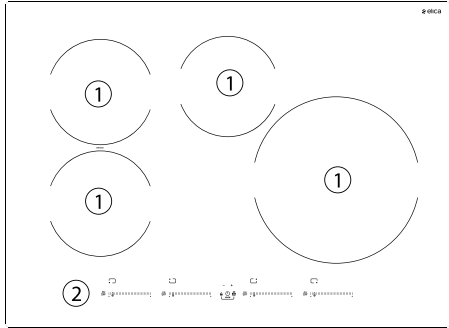

EIV430BL

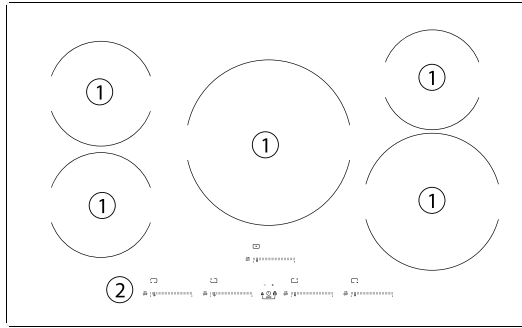

EIV536BL

- 1 - Cooking zones
- 2 - Control Panel

Controls for models EIV430BL (4 COOKING ZONES)

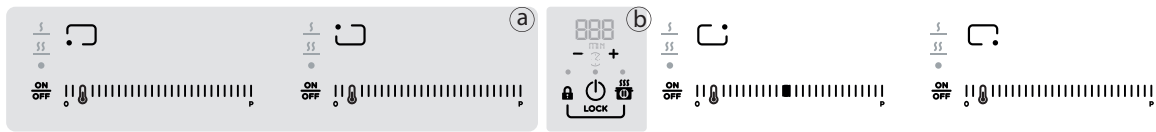

Controls for models EIV536BL (5 COOKING ZONES)

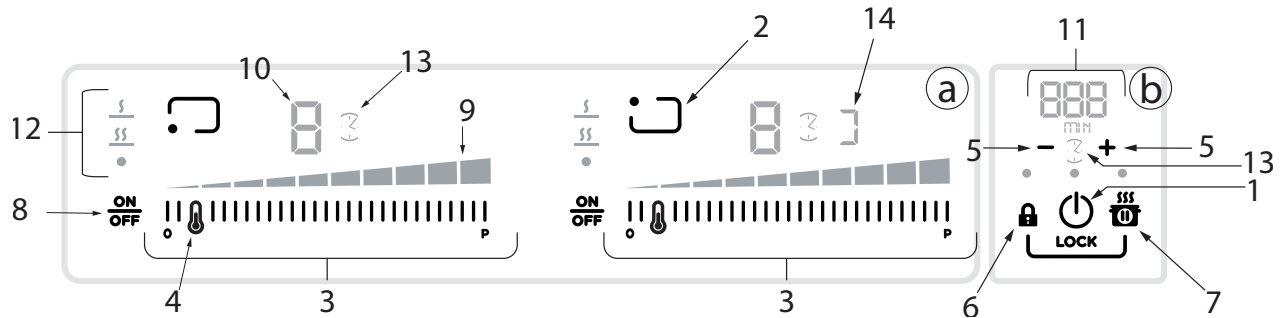
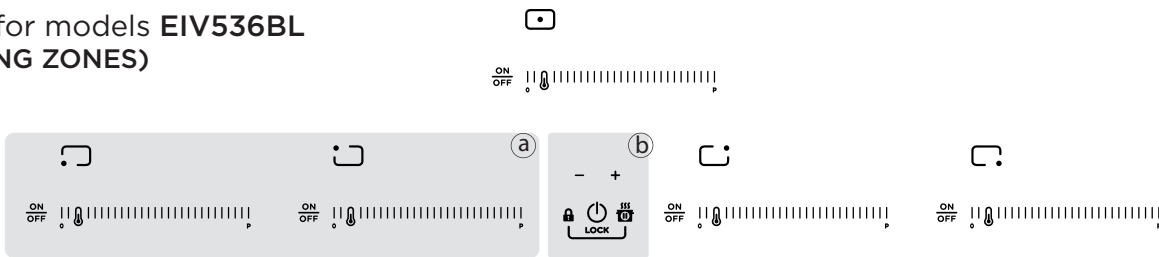

| Keys | | Display / LED | |
|-------|---|---------------|-----------------------------|
| 1 | ON/OFF of the cooktop | 9 | Power Level Display |
| 2 | Cooking zone position indicator | 10 | Cooking zone display |
| 3 | Cooking zone selection Increase/Decrease power level | 11 | Timer display |
| 4 | Activation of temperature manager | 12 | Temperature manager display |
| 5 | Timer activation Increase/Decrease timer value | 13 | Active timer indicator |
| 6 | Key Lock | 14 | Bridge indicator active |
| 6 + 7 | Child Lock | | |
| 7 | Pause / Recall | | |
| 8 | ON/OFF cooking zone | | |

USE

The induction cooking system is based on the physical phenomenon of magnetic induction. The main characteristic of this system is the direct transfer of energy from the generator to the pot.

Advantages:

When compared to electric hobs, your induction hob is:

- **Safer:** lower temperature on the glass surface.
- **Faster:** shorter food heating times.
- **More accurate:** the hob immediately reacts to your commands
- **More efficient:** 90% of the absorbed energy is transformed into heat.
- Moreover, once the pot is removed from the hob, heat transmission is immediately interrupted, avoiding unnecessary heat losses.

COOKING CONTAINERS

Use only pots bearing the symbol 

IMPORTANT

To avoid permanent damage to the hob surface, DO NOT USE:

- containers with less than perfectly flat bottoms.
- metal containers with enamelled bottoms.
- containers with a rough base, to avoid scratching the hob surface.
- never place hot pots and pans on the surface of the hob's control panel
- do not slide pans across the cooking surface.



PRE-EXISTING CONTAINERS

Induction cooking uses magnetism to generate heat. Containers must therefore contain iron. Check if the pot material is magnetic using a magnet. Pots are not suitable if they are not magnetically detectable.

Recommended pan bottom diameters

IMPORTANT

If the pots are not correctly sized, the cooking zones will not turn on.

For details of the minimum pot diameter that needs to be used on each zone, see the illustrated part of this manual.

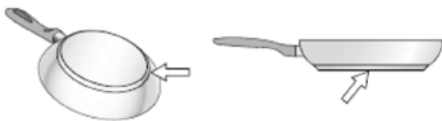

ENERGY SAVING

Recommendations for best results:

- Use pots and pans with a bottom diameter equal to that of the cooking zone.
- Use only pots and pans with flat bottoms.
- Where possible, keep the lid on pots during cooking
- Cook vegetables, potatoes, etc. with a minimal amount of water to reduce cooking time.
- Use a pressure cooker, as it further reduces the energy consumption and cooking time.
- Place the pot in the centre of the cooking zone outlined on the hob.

USING THE COOKTOP

Before you begin, it is important to know:

All functions of this hob are designed in order to comply with the most stringent safety regulations.

For this reason:

- Some functions will not be activated, or will be automatically deactivated, in the absence of pots on the burners or when

they are poorly positioned.

- In other cases the activated functions will be automatically deactivated after a few seconds when the specific function requires a further setting that has not been selected (e.g.: "Turn the hob on" without "Selecting the cooking zone" and the "Operating temperature", or the "Lock Function" or the "Timer" function).

△IMPORTANT

In the case (for example) of prolonged use, the cooking zone may not immediately shut down because it is in the cooling phase; the "H" symbol will appear on the cooking zone display to indicate the execution of this phase.

Wait for the display to turn off before approaching the cooking zone.

COOKING ZONE DISPLAY

the cooking area display indicates:

| | |
|-------------------------------------|---------|
| Cooking zone on | 0 |
| Power level | 1...9-P |
| Residual heat Indicator | H |
| Pot detector | U |
| Temperature manager function active | U |
| Child lock function active | L |
| Pause function | |
| Automatic heat UP function | A |

COOKTOP CHARACTERISTICS

• Safe activation

The product is activated only in the presence of pots on the cooking zone: the heating process does not start or is interrupted if there are no pots, or if these are removed.

• Pot detector

The product automatically detects the presence of pots on the cooking zones.

• Safety shut down

For safety reasons, each cooking zone has a maximum operating time, which depends on the maximum power level set.

• Residual heat indicator

When one or more cooking zones shut down, the presence of residual heat is indicated by a visual signal on the corresponding zone display, by way of the "H" symbol.

Note: Before activating any functions, the desired zone must be activated.

• Power-on

Press (touch)  ON/OFF

The indicator light will turn on to indicate that the cooktop is ready for use. Press again to turn off

Note: This function has priority over the others.

• Selecting the cooking zone

Touch ON/OFF(22) press the Selection bar corresponding to the desired cooking zone.

• 9 Power levels

The hob features 9 power levels

Touch and scroll along the Selection bar: to the right to increase the level of power; to the left to decrease the level of power.

- **Power booster**

The product features a supplementary power level (after level 9), which remains active for 10 minutes, after which the temperature returns to the previously set value.

Touch and scroll along the Selection bar (after level 9) and activate the Power Booster.

The Power Booster level is shown on the display of the selected zone with the symbol "P".

- **Bridge Zones**

Thanks to the Bridge function, the cooking zones are able to work in a combined manner, creating a single zone with the same power level. This function allows evenly distributed cooking with large-sized pots and pans.

The front "Master" cooking zone can be used in combination with the corresponding "Secondary" cooking zone at the back.

To activate the Bridge Function:

- simultaneously select the two cooking zones you want to use
- the Bridge indicator of the "Secondary" cooking zone lights up "J"

- by means of the Selection bar of the "Master" cooking zone it will be possible to set the operating level (Power).





- to deactivate the Bridge Function simply repeat same activation procedure.

- **Temperature manager**

Temperature Manager is a function that allows to set the most suitable pre-set temperature to achieve the desired result (see the power table at the end of this chapter).

Select the desired cooking zone.

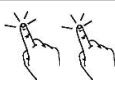
Press once or multiple times  to choose the most suitable level among the ones available:

| | | |
|---|----------|---|
|  | Melting* |  |
|  | Warming* |  |
| *See the Temperature Manager at the end of this chapter. | | |

Press again to turn it off.

The following symbol appears on the display of the zone working in Temperature Manager mode "L"

- **Key Lock**

The Key Lock allows to block the settings of the hob to prevent accidental tampering, leaving the functions that have already been set active.

Activation:

- press 
- The LED over the button will turn on, to indicate that it has been activated.



Repeat the operation to deactivate.

- **Child Lock**

The Child Lock makes it possible to prevent children from accidentally accessing the cooking zone and extraction zone, preventing the activation of any functions.

The Child Lock can only be activated when the product is on, but with the cooking zones off.

Activation:

- remove any pots from the hob
- simultaneously press and hold  and , an acoustic signal indicates that the function is active, and a "L" appears on display. Repeat the operation to deactivate.

- **Timer**

The Timer function is a countdown, which can be set for each cooking zone, even simultaneously.



Note: the timer is a simple warning buzzer, which at the end of the set minutes **DOES NOT turn off the cooking zone.**

Activation/Regulation of cooktop Timer function

- Select the cooking zone (power 1-9).

- Press  to access the Timer function

- Regulate the duration of the Timer:

press the selector , to increase the automatic shut-down time. Press the selector , to decrease the automatic shut-down time.

If desired, repeat the operation for the other cooking zones.

Note: Each cooking zone can have a different Timer set; on the display, the countdown of the last selected hob will be shown for 10 seconds, after which the countdown with the least remaining time will be shown.

When the timer has finished the countdown, there is an acoustic signal (for 2 minutes, or it will stop when one of the buttons on the hob is pressed), while the display will flash, with the symbol "0.00".

Note: on the side of the display of the cooking zone, the following symbol will appear .

- **To switch off the Timer:**

- select the cooking zone

- set the value of the timer to "0", by means of 

Note: the function remains active if no other key is pressed in the meantime.

- **Egg Timer**

The Egg Timer function is a countdown independent of the cooking zones. The Egg Timer is activated by pressing .

Note: to regulate the Egg Timer function, follow the same procedure as for the Timer function.

When the timer has finished the countdown, there is an acoustic signal (for 2 minutes, or it will stop when one of the buttons on the hob is pressed), while the display will flash, with the symbol "0.00".

- **Pause**

The Pause function allows to suspend any function active on the hob, bringing the cooking power to zero.

Activation:

- press 
- a "P" is displayed.

To deactivate the function:

Note: this operation restores the hob settings to those prior to the pause.

- press 
- within 10 seconds scroll to the right along the Selection bar, relating to the cooking zone 2



Note: if the operation is not performed within this time the pause function will remain active.

Note: if after 10 minutes, the Pause Function is not deactivated, the cooktop will turn off automatically.

- **Recall**

The Recall function allows to recover all the hob settings, in case of accidental shut-down.

Activation:

- turn the hob back on  within 6 seconds after shutdown
- press  within the next 6 seconds

- **Automatic Heat UP**



The Automatic Heat UP function allows to reach the set power faster; with this function it is possible to cook food faster, but without the risk of burning it, because the temperature does not exceed the set level.











This function is available for the levels of power 1-8.

Activation:

- press and hold, on the Selection bar, the desired power.
- a "H" is displayed.

POWER TABLES

| Temperature Manager | | Description |
|---|-----------------|---|
|  | Melting* | It identifies a suitable cooking level to slowly melt delicate products without compromising their sensory characteristics (chocolate, butter, etc.). |
|  | Warming | It identifies a suitable cooking level to allow to delicately keep the food at the same temperature, without letting it boil. |

| Power Level | Cooking Type | Use of level (display combines the experience and cooking habits) |
|---------------------|---|--|
| Max power |  Heat quickly | Ideal to quickly increase the temperature of the food up to fast boiling in the case of water or quickly heat cooking liquids. |
| |  Fry - boil | Ideal for browning, starting to cook, frying frozen products, boiling rapidly. |
| High power |  Brown - fry - boil - grill | Ideal for frying, keeping the boil, cooking and grilling (for short times, 5-10 minutes). |
| |  Brown - cook - stew - fry - grill | Ideal for frying, maintaining a simmer, cooking and grilling (for average times, 10-20 minutes), preheating accessories. |
| Medium power |  Cook - stew - fry - grill | Ideal for stewing, maintaining a light boil, cooking (for longer times). Stir pasta. |
| |  Cook - simmer - thicken - stir | Ideal for slow cooking (rice, sauces, roasts, fish) in the presence of liquid (e.g. water, wine, broth, milk), stirring pasta |
| |  Cook - simmer - thicken - stir | Ideal for slow cooking (volume less than one litre: rice, sauces, roasts, fish) in the presence of liquid (e.g. water, wine, broth, milk). |
| Low power |  Melt - thaw - keep warm - stir | Ideal for softening butter, gently melting chocolate, thawing small products. |
| |  Melt - thaw - keep warm - stir | Ideal for keeping small portions of freshly cooked food warm or keeping the temperature of serving dishes and stirring risotto. |
| OFF |  Support surface | Hob in stand-by or off (possible presence of residual heat from the end of cooking, signalled by H-L-O). |

COOKING TABLES

| Category of foods | Dishes or type of cooking | Power level and cooking patterns | | | |
|----------------------------|---------------------------|--|-----------|--|------------|
| | | First stage | Powers | Second stage | Powers |
| Pasta, rice | Fresh pasta | Heating water | Booster-9 | Cooking pasta and maintaining the boil | 7-8 |
| | Fresh pasta | Heating water | Booster-9 | Cooking pasta and maintaining the boil | 7-8 |
| | Boiled rice | Heating water | Booster-9 | Cooking pasta and maintaining the boil | 5-6 |
| | Risotto | Frying and roasting | 7-8 | Cooking | 4-5 |
| Vegetables, legumes | Boiled | Heating water | Booster-9 | Boiling | 6-7 |
| | Fried | Heating oil | 9 | Frying | 8-9 |
| | Sauté | Heating water | 7-8 | Cooking | 6-7 |
| | Stewed | Heating water | 7-8 | Cooking | 3-4 |
| | Fried | Heating water | 7-8 | Browning fried | 7-8 |
| Meats | Roast | Meat browning with oil (if with butter, power 6) | 7-8 | cooking | 3-4 |
| | Grilled | Pre-heating pan | 7-8 | Grilling on both sides | 7-8 |
| | Browning | Browning with oil (if with butter, power 6) | 7-8 | Cooking | 4-5 |
| | Stew | Browning with oil (if with butter, power 6) | 7-8 | Cooking | 3-4 |
| Fish | Grilled | Pre-heating pan | 7-8 | Cooking | 7-8 |
| | Stew | Browning with oil (if with butter, power 6) | 7-8 | Cooking | 3-4 |
| | Fried | Heating oil or fat | 8-9 | Frying | 7-8 |
| Eggs | Omelettes | Heating pan with butter or fat | 6 | Cooking | 6-7 |
| | Omelettes | Heating pan with butter or fat | 6 | Cooking | 5-6 |
| | Soft boiled / boiled | Heating water | Booster-9 | Cooking | 5-6 |
| | Pancakes | Heating pan with butter | 6 | Cooking | 6-7 |
| Sauces | Tomato | Browning with oil (if with butter, power 6) | 6-7 | Cooking | 3-4 |
| | Meat sauce | Browning with oil (if with butter, power 6) | 6-7 | Cooking | 3-4 |
| | Béchamel | Preparing the base (melt butter and flour) | 5-6 | Bring to simmering point | 3-4 |
| Desserts, creams | Custard | Boil the milk | 4-5 | Keep simmering | 4-5 |
| | Puddings | Boil the milk | 4-5 | Keep simmering | 2-3 |
| | Rice pudding | Heat the milk | 5-6 | Keep simmering | 2-3 |

USER SERVICING AND MAINTENANCE INSTRUCTIONS

⚠CAUTION

Before any cleaning or maintenance, make sure the cooking zones are switched off and the heat indicator has turned off.

CLEANING



The cooktop must be cleaned after each use.

⚠IMPORTANT

- Do not use abrasive sponges, scouring pads. Their use, over time, may ruin the glass.
- Do not use chemical irritants, such as oven sprays or stain removers.
- After each use, leave the cooktop to cool and clean it to remove deposits and stains caused by food residue.
- Sugar or food with a high sugar content damages the hob and must be immediately removed.
- Salt, sugar and sand may scratch the glass surface.
- Use a soft cloth, paper towel or specific products to clean the cooktop (follow the Manufacturer's instructions).

DO NOT USE STEAM JET CLEANERS

TROUBLESHOOTING

| Information Code | Description | Possible Causes | Solution |
|---|---|--|---|
|  | The command zone switches off due to an excessively high temperature. | The temperature inside the electronic parts is too high. | Wait for the cooktop to cool before reusing it. |
|  + Acoustic signal | Continuous (permanent) key activation is detected. The interface switches off after 10 seconds. | Water, pots or kitchen tools are on top of the user interface. | Clean the surface, remove any objects from the surface. |
| For all other error signals (E...U...) | Call customer service and report the error code. | | |

Customer Service

Before contacting Customer Service

1. Check that you cannot solve the problem yourself based on the points described in "Troubleshooting".
2. Switch the device off and on again to see if the problem resolves itself.

If the fault persists after the above checks, contact the nearest Customer Service.

Induction hob: EIV430BL / EIV536BL

Rated Voltage: 220 V-

Frequency: 60 Hz

Power consumption: 7 kW (EIV430BL) / 10 kW (EIV536BL)

Current consumption: 32 A (EIV430BL) / 44 A (EIV536BL)

Content: 1 piece.

Made in Mexico

Manufactured by: ELICAMEX S.A. de C.V.

Address: Av. La Noria (Prolongación) No. 102,

Col. Ampliación Parque Industrial Querétaro,

Santa Rosa Jáuregui, C.P. 76215, Querétaro, México.

R.F.C. ELI060102RK8

ELICA North America

TWO-YEAR LIMITED WARRANTY

Register your product in

elica.com

and earn a 3rd year of factory warranty, covering all parts plus in-home labor.

TO OBTAIN SERVICE UNDER WARRANTY

Owner must present proof of original purchase date. Please keep a copy of your dated proof of purchase (sales slip) in order to obtain service under warranty.

PARTS AND SERVICE WARRANTY

For the period of two (2) years from the date of the original purchase, Elica will provide free of charge, non consumable parts or components that failed due to manufacturing defects. During these two (2) years limited warranty, Elica will also provide free of charge, all labor and in-home service to replace any defective parts.

WHAT IS NOT COVERED

- Damage or failure to the product caused by accident or act of God, such as, flood, fire or earthquake.
- Damage or failure caused by modification of the product or use of non-genuine parts.
- Damage or failure to the product caused during delivery, handling or installation.
- Damage or failure to the product caused by operator abuse.
- Damage or failure to the product caused by dwelling fuse replacement or resetting of circuit breakers.
- Damage or failure caused by use of product in a commercial application.
- Service trips to dwelling to provide use or installation guidance.
- Light bulbs, metal or carbon filters and any other consumable part.
- Normal wear of finish.
- Wear to finish due to operator abuse, improper maintenance, use of corrosive or abrasive cleaning products/pads and oven cleaner products.
- When the product has not been operated in accordance with the accompanying instructions for use.

WHO IS COVERED

This warranty is extended to the original purchaser for products purchased for ordinary residential use in North America (Including the United States, Guam, Puerto Rico, US Virgin Islands & Canada).

This warranty is non-transferable and applies only to the original purchaser and does not extend to subsequent owners of the product. This warranty is made expressly in lieu of all other warranties, expressed or implied, including, but not limited to any implied warranty of merchantability or fitness for a particular purpose and all other obligations on the part of Elica North America, provided, however, that if the disclaimer of implied warranties is ineffective under applicable law, the duration of any implied warranty arising by operation of law shall be limited to two (2) years from the date of original purchase at retail or such longer period as may be required by applicable law.

This warranty does not cover any special, incidental and/or consequential damages, nor loss of profits, suffered by the original purchaser, its customers and/or the users of the Products.

WHO TO CONTACT

To obtain service under warranty or for any service related question:

- **USA & CANADA - Western Provinces**
SERVICE POWER
888 732 8018
elica@servicepower.com
- **CANADA - Ontario Province**
AGI Services
888 651 2534
service@agintl.qc.ca
- **CANADA - Quebec & Atlantic Provinces**
Ateliers G. Paquette
800 463 0119
service@ateliersgpaquette.com

To ensure prompt after-sales service, when you call we will kindly ask you to provide the following information:
model, 12 NC and date of purchase on original invoice.

12NC: _____

Model: _____

Serial No: _____

Date of purchase on original invoice: _____