

SOFIA 48" PRO RANGE

















CODE ID

SOFIA 48" PRO INDUCTION RANGE WITH GRIDDLE



F6PIR485GS1



-  Easy Clean Ceramic Glass
-  Dual Max Power
-  Trilaminare Stainless Steel Griddle
-  Power Boost Burner
-  Pan Detection system
-  Residual Heat Sensor
-  Dual True Convection (main oven)
-  Single True Convection (accessory oven)
-  Soft Closing Door
-  Self Clean Oven
-  1 Telescopic Rack
-  Cool Touch Door
-  Digital Controls
-  Meat Probe
-  Fast Pre-Heat

SUMMARY DESCRIPTION

This masterfully designed 48" induction range is a first of a kind all-electric pro range alternative for those who prefer a traditional 48" range configuration with the built-in griddle feature. To add to the flexibility of this range, the trilaminare griddle can be removed to have access to the induction elements below. The instant response and precise control of the induction are ensured by the presence of professional control knobs. Below the cooking surface, two self-cleaning true convection ovens with intuitive multiple baking and broiling functions and the convenience of telescoping racks encourage you to cook the way you want.

COLOR KIT

 STAINLESS STEEL	GLOSSY WHITE RAL 9016	
 MATTE BLACK RAL 9004	MATTE WHITE RAL 9016	
 GLOSSY BLACK RAL 9004	MATTE GREY RAL 9007	
 GLOSSY RED RAL 3003		

OPTIONAL ACCESSORIES

PDRKIT48 ...	Color kit
F6BG48STD	Standard trim
F6BG48HBT	High back trim
F6BG48BCI	Island trim
FMTRP30	Telescopic rack
FMTRP18	Telescopic rack

SPECIFICATIONS

COOKING SURFACE

Seven powerful premium European inductors
 4 Single Induction cooking zones
 1 Dual Max Power with Ø 11" cooking zone
 2 Bridge Zone Elements
 One integrated trilaminare Griddle + Lid
 Booster function for each cooking zone
 Residual heat and Power-on Indicators
 Pot Detection System
 Child Lock Function
 Automatic Heat-up

OVEN

Dual True Convection in main oven and
 True Convection in accessory oven
 Self-cleaning oven with Multifunction baking
 Black Porcelain enamel interior
 Cool to the touch soft closing doors
 Extra-large baking cavity and viewing area
 3 Halogen lights on main oven
 2 Halogen light on accessory oven
 2 Chrome racks per oven
 1 Telescopic rack per oven
 1 Meat probe
 Total capacity 123 lt and 63,4 lt
 Total capacity 4,34 cu. ft. and 2,24 cu. ft.

OVEN FUNCTIONS

Bake
 Broil
 Roast
 True Convection
 Warm / Proof / Dehydrate
 Meat Probe
 Self-Clean
 Sabbath Mode
 Convection Roast

SOFIA 48" PRO RANGE

SOFIA 48" PRO INDUCTION RANGE WITH GRIDDLE

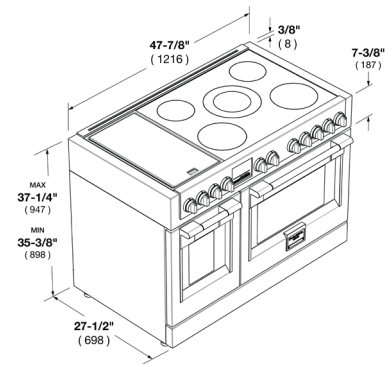

CODE ID		F6PIR485GS1	
Series - Stainless Steel Aesthetics		Sofia Full Electric 48" - Professional	
COOKTOP			
Type Cooking Surface		Induction Ceramic Glass	
Knobs		7 Knobs	
Induction Special Features			
Pot Detection System		Child lock function	
Cooling fan system			
Power management with indication		Main dual burner and griddle power unaffected	
INDUCTION CONTROL FEATURES			
Simmer Function 205°F / 95°C (inside the pot 195°F / 90°C) only available on bridge or griddle left zones			
Power levels 1 to 9		Digital display for power level indication	
		Melting Function 113°F / 45°C inside the pot 108°F / 42°C	
		Warming Function 158°F / 70°C inside the pot 149°F / 65°C	
		Automatic high heat and reduce	
Knob for power setting		Residual heat indication	
5 + 2 Bridge zone elements			
Integrated trillaminate Griddle over a dedicated 2-zone bridge element			
Front Left	Power L9 Booster	Inductor 9" (230mm)	2300W 3700W
Rear Left	Power L9 Booster	Inductor 7" (180mm)	1850W 3000W
Middle dual circuit	Power L9 Booster	Inductor 11" (280mm)	3000W 5500W
Middle single circuit	Power L9 Booster	Inductor 7" (180mm)	1850W 2600W
Front Right	Power L9 Booster	Inductor 9" (230mm)	2300W 3700W
Rear Right	Power L9 Booster	Inductor 7" (180mm)	1850W 3000W
Griddle Front + Rear Left	Power L9 Booster	Inductor x 2	2 x 1850W 3000W
OVEN			
Type - Oven Type - Temperature Regulation		ELECTRIC PIRO - Various (see explanation of codes) - Electronic	
Functions			
Pyrolytic Self-Clean with automatic door latch		True European Convection Bake (Multi level)	
Convection Broil		Convection Roast	
Pizza (Lower Convection)		Bake	
Broil		Dehydrate	
Thaw (Defrost)		Proof (Warm)	
Keep warm (Warm Plus)		Oven Lights	
Fast Preheat			
Control Panel			
Control type		Modular LED - Electronic	
Clock, Temperature, Function Display		LED	
Commands - Language		4 Knobs / 6 Touch Keys - English	
Electric Oven Features			
Preset/Last used temperature memory		Preheat gauge (25%, 50%, 75%, 100%)	
Automatic Fast Preheat		Child Door Lock	
Commands Lock		Sabbath mode	
12/24 hours clock format		°C/°F degree unit	
Oven Door(s)			
Oven Glass Window		Deep Embossed Window	
Door Cooling System		4 Pane Heat Resistant (cool touch) Glass	
Soft closing system			
Door Hinges		Heavy Duty Steady Tilt	
Handle style		Stainless Steel Tube d30mm, metal end caps	
Oven Cavity			
		18" OVEN	30" OVEN
Total Capacity (lt)		63,4	123
Total Capacity (cu. ft.)		2,24	4,34
Cavity Enameling Colour		Black	Black
Rack Positions		6	6
Oven Lights		2x20W Halogen	3x20W Halogen
Heating Element			
Broil Upper Heating Element		2100 W (240V)	3500W (240V)
Upper Auxiliary Element Wattage		700 W (240V)	1032W (240V)
Concealed Bake Heating Element		1750 W (240V)	3000W (240V)
Convection Element Wattage		1X2500 W (240V)	2x1300W (240V)
Oven Accessories			
Chromed racks (2)		Chromed racks (2)	
		Enameled Grill set (basin + anti splash)	
Telescopic chromed rack		Telescopic chromed rack	
		Meat probe	
DIMENSIONS WEIGHTS			
Overall dim - Width Height Depth (Included Handle)		47 7/8" (1216mm) 35 3/8" to 37 1/4" (898 - 947mm) 30" (763mm)	
Gross weight Net weight		214,2 kg - 472,2 lb 188,7 kg - 416,0 lb	
POWER / RATINGS (208/240 V, 60 HZ)			
KW/Amps rating at 120-240V, 60Hz		20.3 kW - 84.6 A	
KW/Amps rating at 120-208V, 60Hz		17.6 kW - 84.6 A	
Cable + Plug Cable length		Nema 14 - 50P 51" (1300 mm)	
INSTRUCTIONS FOR USE			
Use & Care Manual - Installation Manual		EN, SP, FR	

SOFIA 48" PRO INDUCTION RANGE WITH GRIDDLE

F6PIR485GS1

DIMENSIONS - CUTOUT REQUIREMENTS

Dimensions in brackets are in millimeters

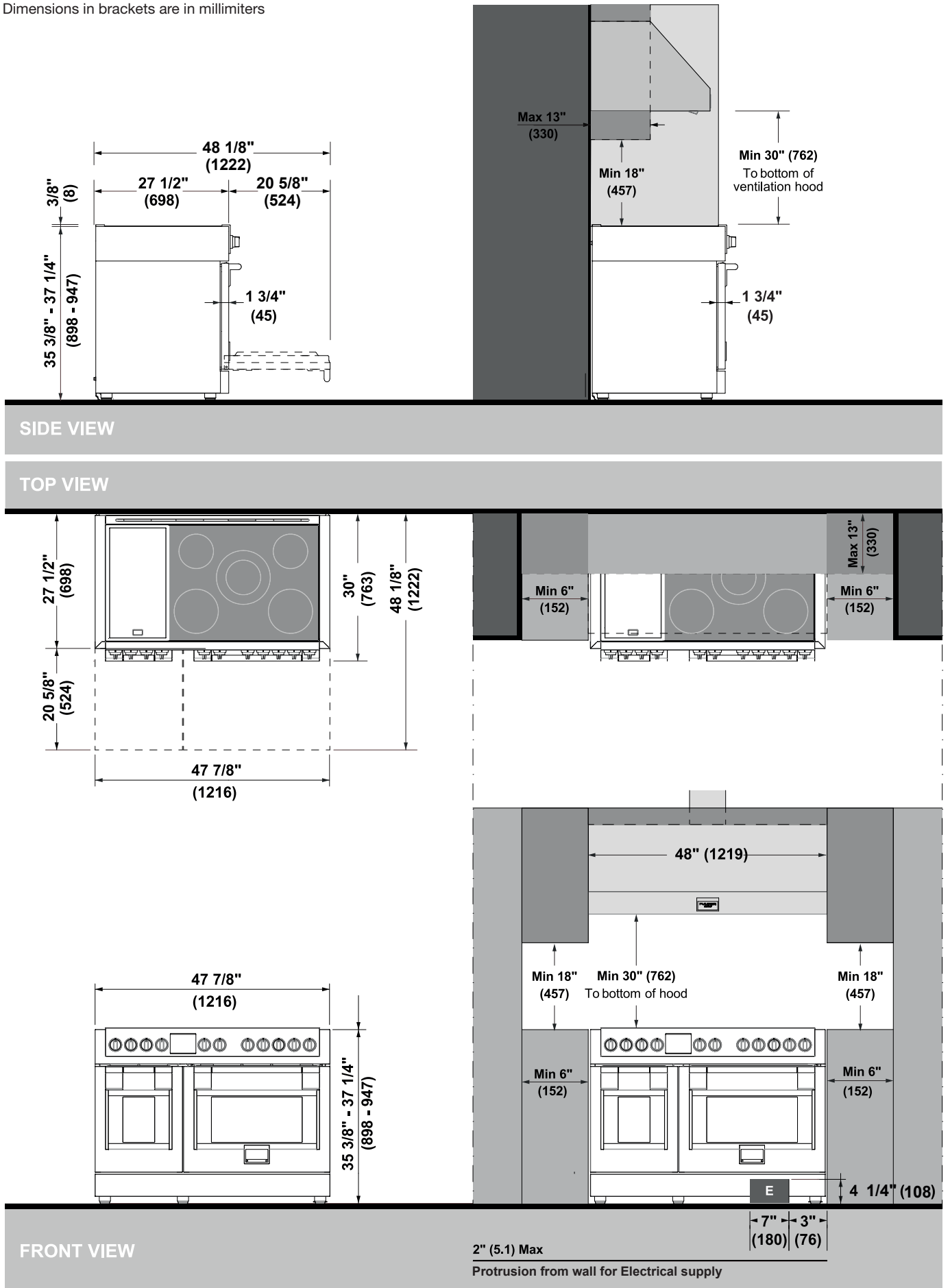

INSTALLATION REQUIREMENTS

For detailed installation specifications consult the installation requirements page or each single product installation manual.

Ensure your installation also complies with local and national building and fire codes.

FLUSH ISLAND TRIM INSTALLATION

For island installation, maintain 2-1/2 inch minimum from cutout back edge of countertop and 3 inch minimum from cutout to side edges of countertop (see view).

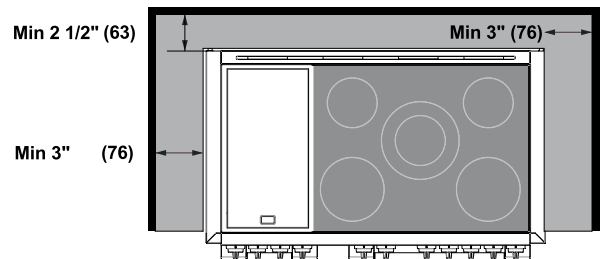

ELECTRICAL REQUIREMENTS

ELECTRICAL SUPPLY

120/240 V - 60 Hz 20.3 kW 84.6 A*
 120/208 V - 60 Hz 17.6 kW 84.6 A*

SERVICE

50 Ampere dedicated circuit

POWER CONNECTION

NEMA 14-50P

POWER MANAGEMENT SYSTEM

Power Management Area

A	Decreases by 4/5 Levels
B	Decreases by 1/2 Levels

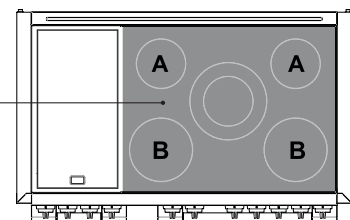

*Considering all the power consuming features of this appliance; the theoretical potential cumulative power draw could exceed the required circuit breaker rating of 50 amps. We must stress that under normal expected daily usage, the probability of this ever happening is exceptionally low. Such a power draw would require that both ovens are operating and all surface elements have been set to their maximum settings simultaneously.

This model is equipped with a Fulgor Milano proprietary Power Management System that will prevent the tripping of circuit breakers in the event of an extreme power use scenario.

The system is designed so in the event that 50 amps total draw is exceeded for several minutes, it will enter into 'POWER MANAGEMENT' mode in which case 4 of the 5 surface induction elements of the main cooking area will be temporarily reduced in their setting in accordance to the above diagram and description: the rear inductors' settings will be reduced by 4 or 5 levels and the front inductors will be reduced by 1 or 2 levels.

The amount of reduction will be determined by the current power draw at the time the system is engaged. Additionally, any active BOOST and AUTOMATIC HEAT UP functions in this region will be turned OFF to reduce power draw.

You will note that the symbol 'POWER MANAGEMENT' will illuminate on the cooking surface during this time. Functionality of the ovens and of the two left-most induction elements will remain unaffected and the central double induction element will still be able to maintain a power level setting of 9.

Once the total power draw drops below 42 amps for 30 seconds, the cooktop will return to its full operational ability and previous settings will be restored automatically except for BOOST or AUTOMATIC HEAT UP which would need to be reinitiated if so desired. Again, it is highly unlikely you will ever see the Power Management system engaged during normal daily use.

Specification sheets are for planning purposes only. Always refer to installation instructions, always consult the countertop fabricator/supplier prior to determining counter opening. Consult your HVAC engineer for your specific ventilation requirements. Always refer to installation instructions accompanying product or on available on www.fulgor-milano.com/us/en for your specific model number. Fulgor Milano retains the right to change product specifications or design without notice.