







# SOFIA PROFESSIONAL 30"

30" PROFESSIONAL WARMING DRAWER - STAINLESS STEEL

CODE ID

**F6PWD30S1**



-  Sliding Telescopic Rails
-  Keep Warm Function
-  Leavening
-  Slow Cooking
-  Thawing
-  Soft Closing



## COLOR KIT

	STAINLESS STEEL
	MATTE BLACK RAL 9004
	GLOSSY BLACK RAL 9004
	GLOSSY RED RAL 3003
	GLOSSY WHITE RAL 9016
	MATTE WHITE RAL 9016
	MATTE GREY RAL 9007

## WARMING DRAWER 30"

Knob Control  
Heavy Duty full extendable telescopic rails  
Large capacity 2,1 cu. ft.  
Convection heating system for even heat distribution  
All stainless steel structure  
Warming Temperature range; min. 86 °F up to 190 °F  
Slow closing assistance  
2 Internal lights  
Non-slip rubber mat

## DRAWER 30" FUNCTIONS

Pre-heat dishes  
Pre-heat coffee cups  
Keep warm ready food  
Defrosting  
Leavening dough  
Slow cooking min. 86 °F up to 190 °F

## OPTIONAL ACCESSORIES

PWDKIT30 ... Colour kit



This product meets ADA (Americans with Disabilities Act) requirements. Please check with your local municipality's codes and stipulations for additional details to ensure compliance.

# SOFIA

30" PROFESSIONAL WARMING DRAWER

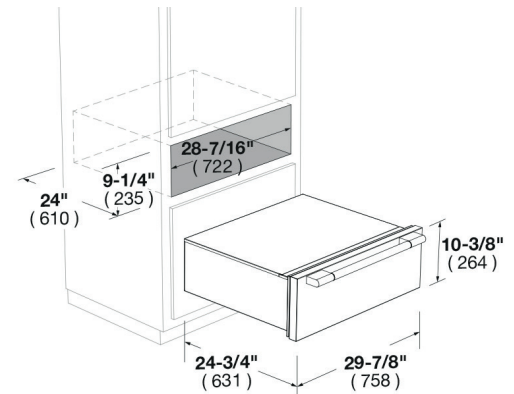

CODE ID	F6PWD30S1 - 30" PROFESSIONAL WARMING DRAWER	
Type	Warming Drawer	
Front finish	Stainless Steel with Pro - Handle	
Internal shelf	Inox	
Compatible with ovens	F6PSP30S1 - F6PDP30S1	
<b>PERFORMANCE</b>		
Maximum temperature	194°F / 90°C	
Cooking at low temperature (slow cooking)	•	
Leavening	•	
Heating dishes and food	•	
Slow close assistance	•	
Open / Close push - pull system	-	
<b>CONTROL</b>		
Thermostat	86°F - 194°F / 30°C - 90°C	
Fan assisted	•	
Function Indicator / Thermostat on/off	•	
<b>SAFETY</b>		
Safety front	•	
<b>ELECTRICAL SPECIFICATIONS</b>		
Max power absorbed (W)	1100W	
Power (V-Hz)	120/60	
Power cord	•	
Plug	•	
<b>CAPACITY</b>		
Volume (cbft-litri)	2,1	61.4
<b>DIMENSIONS</b>		
Overall dim - Width	29 7/8"	(758 mm)
Overall dim - Height	10 3/8"	(264 mm)
Overall dim - Depth	23"	(583 mm)
Door Depth with Overlay	2 1/8"	(54 mm)
Door Depth with Pro Handle	4 11/16"	(119 mm)
Cut-out - Width	28 7/16"	(722 mm)
Cut-out - Height	9 1/4"	(235 mm)
Cut-out - Depth	24"	(610 mm)
<b>WEIGHT</b>		
Net Weight	68.5 lbs	31.0 Kg
Gross Weight	75.2 lbs	34.1 Kg