

Contents

1	IMPORTANT SAFETY INSTRUCTIONS	4
1.1	Definition	4
1.2	State of California Proposition 65 Warning	4
1.3	Intended purpose	5
1.4	Installation warnings	5
1.5	Installation cautions	7
1.6	Usage warnings	7
1.7	Usage cautions	9
1.8	Disposal Warning	9
1.9	How to read the user manual	10
2	Description	11
2.1	General Description	11
2.2	Description of parts	12
2.3	Control panel	12
2.4	Available accessories	13
3	Use	15
3.1	Instructions	15
3.2	Preliminary operations	15
3.3	First use	15
3.4	Using the accessories	17
3.5	Ventilation	18
3.6	Using the refrigerator compartment	19
3.7	Using the freezer compartment	19
3.8	Noises during operation	20
3.9	Heated front surface	21
3.10	Turning the appliance off	21
3.11	Food storage advice	21
4	Cleaning and maintenance	23
4.1	Instructions	23
4.2	Cleaning the appliance	23
4.3	Defrosting	24
4.4	Interior lighting	24
4.5	What to do if...	24
5	Installation	26
5.1	Electrical connection	26
5.2	Positioning	26

We advise you to read this manual carefully, as it contains all the instructions for maintaining the appliance's aesthetic and functional qualities.

For further information on the product: www.smeg.com



Instructions

1 IMPORTANT SAFETY INSTRUCTIONS

WARNING: If the instructions contained in this manual are not followed precisely, fire or explosion may result causing property damage, personal injury or loss of life.

READ AND SAVE THESE INSTRUCTIONS

1.1 Definition



DANGER:

not following instructions immediately may result in loss of life or severe injuries.



WARNING:

not following instructions may result in loss of life or severe injuries.



CAUTION:

indicates a potentially hazardous situation which, if not avoided, may result in minor to moderate injury.



NOTE:

Important information.

1.2 State of California Proposition 65 Warning



WARNING

This product can expose you to chemicals including vinyl chloride, which is known to the State of California to cause cancer and birth defects or other reproductive harm. For more information go to www.P65Warnings.ca.gov.



1.3 Intended purpose

This appliance is intended to be used in household and similar applications such as:

- staff kitchen areas in shops, offices and other working environments;
- farm houses and by clients in hotels, motels and other residential type environments;
- bed and breakfast type environments;
- catering and similar non-retail applications.
- This appliance is intended for indoor household use only.
- This appliance is suitable for the refrigeration and storage of fresh and frozen food.
- This appliance is not designed or manufactured for professional use.

1.4 Installation warnings



WARNING

- Use two or more people to move and install this appliance.
- The appliance is heavy and it must be secured during transport and installation.
- Do not install this appliance:
 - outdoor,
 - in manufactured (mobile) homes, in recreational vehicles (RVs) or boat.
 - near a heater or flammable material,
 - in a room where there is a risk of freezing,
 - in direct sunlight or exposed to heat from stoves.
- Always place the appliance in a dry and well ventilated room.
- Depending on its climate class, the appliance can be used in different temperature conditions. The climate class is specified on the nameplate of the appliance.
- Observe all codes and ordinances in force.
- Plug into a grounded 3-prong outlet.
- Do not remove ground prong.
- Do not use an adapter plug.
- Do not use an extension cord.
- Do not twist or tie the power cord.
- Do not pull or bend the power cord.
- Do not damage the power cord when moving the appliance.
- Have the wall outlet and circuit



Instructions

- checked by a qualified electrician to make sure the outlet is properly grounded.
- Unplug the refrigerator before servicing.
 - Only qualified service personnel should perform repairs. Service personnel must disconnect the power supply before servicing this unit.
 - Never unplug an appliance by pulling the power cord. Always grip the plug firmly and pull straight out from the outlet to prevent damaging the power cord.
 - Do not damage or puncture refrigerant tubing.
 - Do not damage the refrigerant circuit.
 - Do not attempt to repair or replace any part of this appliance unless specifically recommended in this manual. Any other servicing should be done by a qualified technician.
 - Do not scatter the packing materials. Sort the various items of waste and take them to the nearest specialized waste collection facility.
 - Do not use sharp instruments, rubbing alcohol, flammable fluids, or abrasive cleaners to remove tape glue. Wipe with warm water only.
 - Keep ventilation openings, in the appliance enclosure or in the built-in structure, clear of obstruction.



1.5 Installation cautions



CAUTION

- Leave the appliance standing vertically for at least two hours before turning it on for the first time.
- Leave sufficient space around the appliance and install it on a flat surface.
- Never use the open door to lever the appliance into place when fitting.
- Avoid exerting too much pressure on the door when open.
- Pay attention not to scratch or damage the floor when installing the appliance.
- Do not wiggle or drag the appliance when trying to move it, as floor damage could occur.
- Never cover or block the appliance's ventilation openings.

1.6 Usage warnings



WARNING

- Read all instructions.
- This appliance is not intended for use by people (including children) with reduced physical, sensory or mental capabilities, or lack of experience and knowledge, unless they have been given supervision or instruction concerning use of the appliance by a person responsible for their safety.
- Do not leave children unattended:
 - Children should not be left alone or unattended in the area where the appliance is being used. Never allow children to sit or stand on any part of the appliance.
- Never allow children to play with the refrigerator and let them use the drawers, shelves and others parts of the appliance only as described in this handbook.
- Do not attempt to repair, disassemble or modify the appliance yourself.
- Do not damage the refrigerant circuit.



Instructions

- Do not use the appliance if the power plug or cord is damaged.
- Do not use electrical appliances inside the food storage compartments of the appliance, unless they are of the type recommended by the manufacturer.
- Use nonflammable cleaner.
- Do not climb, stand or hang on the shelves in the refrigerator. This could result in severe injuries or in damage to the appliance.
- Bottles containing strong alcoholic drinks must be tightly closed and stored vertically.
- Never touch frozen product straight from the freezer or put it in your mouth. This can cause burn injury due to very low temperatures.
- Do not store explosive or flammable substances, such as gasoline in or in the vicinity of this refrigerator or use gasoline or other flammable vapors or liquids in the vicinity of this or any other appliance.
- Do not store or use gasoline or other flammable vapors, liquids or materials near this or any other appliance.
- Do not store objects on the top of the appliance.
- Do not store bottled or canned liquids in the freezer compartment.
- Unplug your appliance before cleaning and making repairs.
- Always unplug the appliance from the power mains in the event of a breakdown, maintenance, when replacing the light bulb or cleaning.
- Do not insert the power plug into a wall socket with wet hands.
- Use nonflammable cleaner.
- Do not use sharp objects when removing ice and frost in order not to damage the appliance's walls.
- Do not defrost or clean the appliance with a steam cleaner.
- Do not use a hair dryer to dry the inside of the refrigerator.
- Do not sit or lean on the door or any open drawers.
- Do not store inflammable, explosive or volatile substances.
- Do Not Use Water on Grease Fires - Smother fire or flame or use dry chemical or foam-type extinguisher.



- Organic compounds, acids and essential oils can corrode the seals and plastic surfaces if left in contact with them for extended periods.
- Bottles containing strong alcoholic drinks must be tightly closed and stored vertically.
- Do not put frozen food straight from the freezer compartment into your mouth.

1.7 Usage cautions



CAUTION

- For safety reasons and to avoid damage to your appliance, never sit, stand or lean on the refrigerator door.
- Never cover or block the appliance's ventilation openings.
- Do not refreeze frozen foods which have partly or completely defrosted.
- Do not strike or apply too much force to any glass surface.
- Never move the appliance by pulling on the door or the handle.
- Do not use the appliance to cool rooms for any reason.
- Wear proper apparel. Loose-fitting or hanging garments should

never be worn while using the appliance.

- Observe maximum storage times and expiration dates of frozen goods.

1.8 Disposal Warning



DANGER

- Risk of child entrapment. Before you throw away your old refrigerator/freezer:
 - Remove doors.
 - Leave shelves in place so children may not easily climb inside.
- Destroy or recycle the carton, plastic bags, and any exterior wrapping material immediately after the refrigerator is unpacked. Children should NEVER use these items to play. They can cause suffocation and death.



WARNING

- Before you throw away your old refrigerator/freezer:
 - Pull out the power cord plug.
 - Cut off the power cord.
 - Have refrigerant removed and disposed by a qualified service technician.



Instructions

- Do not allow children to climb, stand or hang on the shelves in the refrigerator.
- Never allow children to play with the refrigerator.

**SAVE THESE
INSTRUCTIONS**

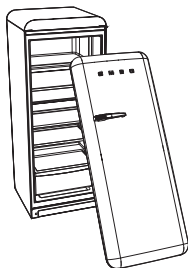

1.9 How to read the user manual

This user manual uses the following reading conventions:

Instructions



General information on this user manual, on safety and final disposal.

Description



Description of the appliance and its accessories.

Use



Information on the use of the appliance and its accessories, food storage advice.

Cleaning and maintenance



Information for proper cleaning and maintenance of the appliance.

Installation



Information for the qualified technician: Installation, operation and inspection.



2 Description

2.1 General Description

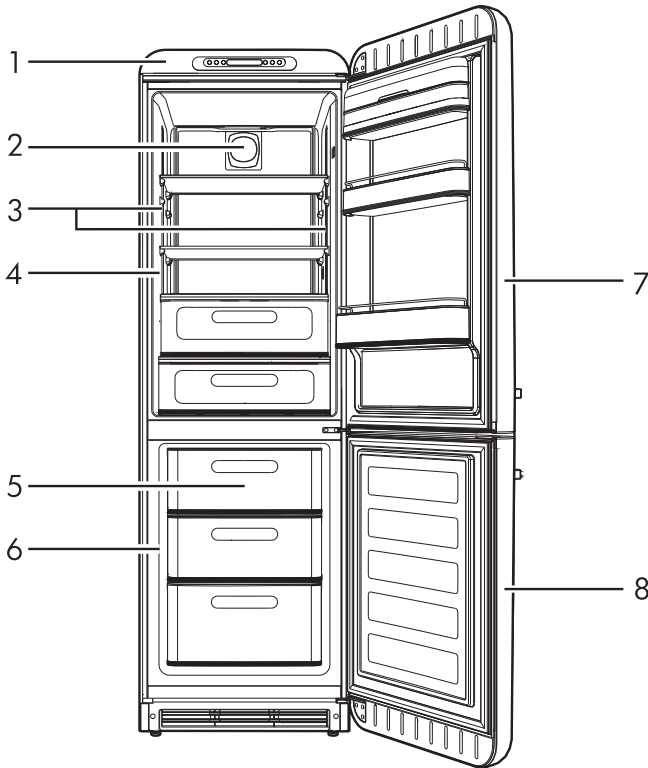

- 1 Control panel
- 2 Fan
- 3 Interior lighting
- 4 Refrigerator compartment
- 5 Quick freeze drawer
- 6 Freezer compartment
- 7 Refrigerator door
- 8 Freezer door



Description

2.2 Description of parts

Control panel

For setting the temperature inside the refrigerator and freezer compartments.

Fan

Distributes the temperature and reduces condensation on the shelves and other surfaces.

Interior lighting

The interior of the appliance is lit when the door is opened.

2.3 Control panel

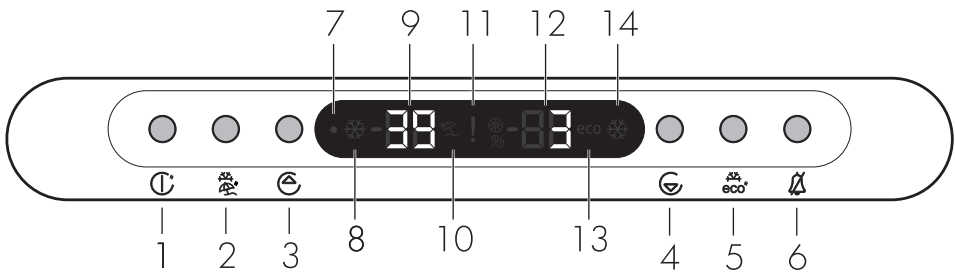

- 1 Turning ON/OFF the appliance
- 2 Refrigerator compartment supercold function ON/OFF button; Vacation function (long press)
- 3 Refrigerator compartment temperature setting button
- 4 Freezer compartment temperature setting button
- 5 Freezer compartment supercold function ON/OFF button; "ECO" function (long press)
- 6 Alarm deactivation button.

Refrigerator compartment

For storing fresh foods.

Quick freeze drawer

For quickly freezing fresh food.

Freezer compartment

For storing frozen foods, freezing fresh foods and producing ice cubes.

- 7 Appliance off indicator.
- 8 Refrigerator compartment supercold function indicator.
- 9 Refrigerator compartment temperature display.
- 10 Vacation function indicator.
- 11 Alarm warning indicator.
- 12 Freezer compartment temperature display.
- 13 "Eco" function ON/OFF indicator.
- 14 Freezer compartment supercold function indicator.



2.4 Available accessories



NOTE:

Not all accessories are available on some models.

Shelves

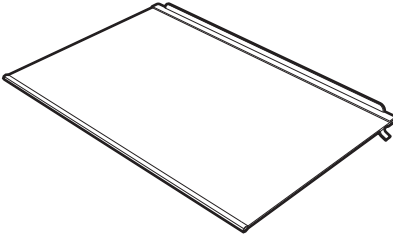

For optimizing refrigerator space and placing foodstuffs inside the refrigerator compartment.

Fruit and vegetable drawer

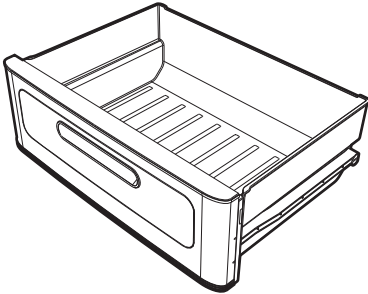

For storing fruit and vegetables, maintaining a constant humidity level.

Supercold drawer

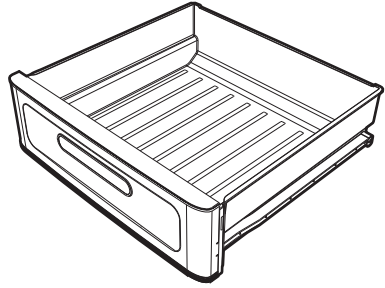

Can be used for maintaining freshness and flavor of delicate food such as meat, fish and lightly frozen foods for a longer time period, since temperature is kept constantly between +28°F and +37°F.



NOTE:

Do not place food to be frozen or trays to make ice in the super-cold compartment.

Freezer drawers

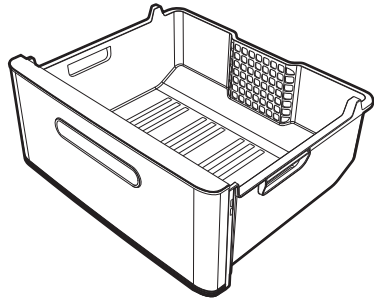

For storing frozen or deep-frozen food.



Description

Door balconies and shelves

For storing foodstuffs in small containers.
The shelf in the lower part of the door is useful for storing bottles.

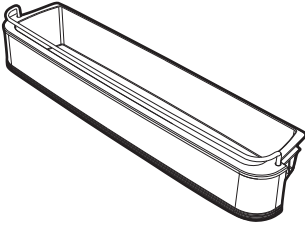

NOTE:

The accessories intended to come into contact with food are made of materials that comply with the provisions of current legislation.



NOTE:

Supplied and optional accessories can be requested to Authorized Service Centers. Use only original accessories supplied by the manufacturer.



3 Use

3.1 Instructions

WARNING

- Do not store explosive or flammable substances, such as gasoline in or in the vicinity of this refrigerator or use gasoline or other flammable vapors or liquids in the vicinity of this or any other appliance.
- Do not climb, stand or hang on the shelves in the refrigerator. This could cause serious injury or result in damage to the appliance.
- Never allow children to play with the refrigerator and let them use the drawers, shelves and others parts of the appliance only as described in this handbook.
- Bottles containing strong alcoholic drinks must be tightly closed and stored vertically.
- Never touch frozen product straight from the freezer or put it in your mouth. This can cause burn injury due to very low temperatures.

CAUTION

- Do not use sharp objects when removing ice and frost in order not to damage the appliance's walls.
- Organic compounds, acids and essential oils can corrode the seals and plastic surfaces if left in contact with them for extended periods.

3.2 Preliminary operations

1. Remove any protective film from the outside or inside of the appliance, including accessories.
2. Remove any labels (apart from the technical data plate) from the accessories and shelves.
3. Remove and wash all the appliance's accessories (see 4 Cleaning and maintenance).

3.3 First use



NOTE:

After installing or repositioning the appliance, wait at least two hours before activating it.

1. Keep the ON/OFF button on the control panel  pressed for 3 seconds to switch on the appliance.



NOTE:

After a power failure, the appliance will automatically switch on with the previously selected settings.



NOTE:

The appliance is set by default to **+41 °F** for the refrigerator and **0 °F** for the freezer.



Use

Temperature setting



NOTE:

The refrigerator temperature can be set between **+34 °F** and **+46 °F**.

The freezer temperature can be set between **0 °F** and **-11 °F**.

1. To set the refrigerator temperature, press the button; press the button for the freezer.
2. The set temperature will be shown on the relevant display.

2. The indicator will turn on in the display, and the temperature will not be shown .



NOTE:

Remove the stored products from the refrigerator compartment.



NOTE:

To prevent the formation of unpleasant odors, a temperature of about 59 °F will be kept inside the refrigerator compartment.

Refrigerator supercold function



NOTE:

The refrigerator supercold function is used for quick cooling of large quantities of food.

1. Press the button to activate/deactivate the supercold function, the relevant indicator turns on.
2. After 1 hour the supercold function is switched off automatically. The refrigerator compartment returns to its previous setting.

ECO mode

1. To activate/deactivate the ECO mode, keep the button pressed for 3 seconds.
2. The indicator will turn on in the display.
3. The appliance will reduce power consumption after 6 hours since the activation of the ECO mode.



NOTE:

The ECO mode is deactivated after a power failure or when the appliance is switched off.

Vacation function

Useful during periods of prolonged absence; the Vacation function allows you to turn off the refrigerator compartment while keeping the freezer active.

1. To activate/deactivate the Vacation function, keep the button pressed for 3 seconds.



NOTE:



Activation of the supercold function (refrigerator/freezer) deactivates the ECO mode.



Alarm for door open

When the refrigerator compartment door remains open for a long time, the appliance sounds to warn the user that door should be closed; press the  button to deactivate the alarm.

High temperature alarm

If the temperature in the compartment is high due to prolonged power failure or to a fault of the appliance, an alarm will sound and the  indicator will turn on in the display. Check food inside the refrigerator compartment and press the  button to deactivate the alarm.

3.4 Using the accessories

Shelves

CAUTION

- Glass shelves and covers are heavy, use special care when removing them.

These can be positioned at different heights on the guides according to requirements. Each shelf has a safety fitting to prevent it from being accidentally removed. To extract them fully, lift up the rear part (1) and remove them (2).

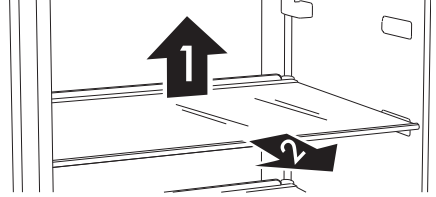

NOTE:

Perishable foods should be placed on the rear part of the shelves where the temperature is lower.

Door balconies and shelves

Suitable for storing eggs, butter, dairy products, preserves and other small food packages/containers. The lower part of the door has a shelf for bottles. Avoid placing excessively heavy bottles on the shelf and do not let them drop onto the bottom when inserting them.

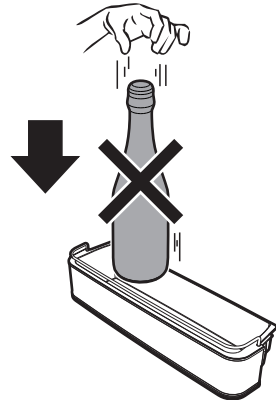



Fruit and vegetable drawer

Located at the bottom of the refrigerator compartment, which is fitted with a glass shelf to cover fresh foods that require constant humidity for optimum storage.

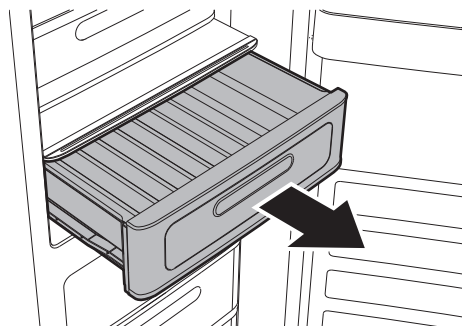

NOTE:

Storing vegetables with high content of water can generate condensation on the glass shelf. This is a natural phenomenon which does not affect the appliance's operation in any way.

Freezer drawers

For storing frozen foods and foods to be frozen. To remove them, pull them towards you and lift the front part of each drawer.

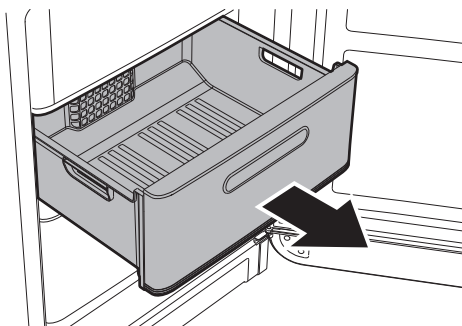

3.5 Ventilation



NOTE:

Before introducing food into the appliance, seal it thoroughly.

The forced recirculation air in the appliance is free of humidity and quickly dries the food inside.

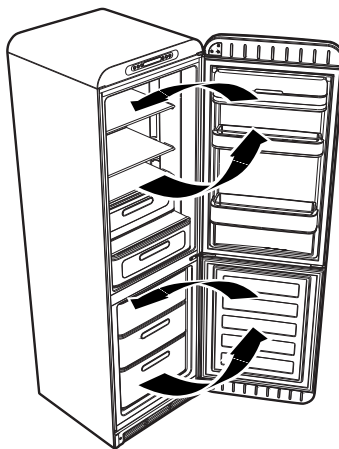

The inner ventilation system cools food more rapidly and keeps refrigeration homogeneous inside the appliance.



3.6 Using the refrigerator compartment

Arranging food

Arrange food on the various shelves, making sure that they are wrapped and covered hermetically. This precaution ensures that:

- the flavor, moisture and freshness of the foods are preserved;
- any contamination of foods with odors or tastes from other foods can be avoided;
- the humidity level inside the refrigerator is prevented from becoming too high as a result of the normal transpiration of food (especially fresh fruit and vegetables). In some operating conditions (rise in ambient temperature and humidity, more frequent opening of the door) this might cause condensation to form on the shelves.



NOTE:

Always allow hot foods and drinks to cool to room temperature before putting them in the appliance.

Storage life table

Foodstuff	Time
Eggs, smoked meats, marinated foods, cheese	max 10 days
Root vegetables	max 8 days
Butter	max 7 days
Pastries, fruit, ready meals, fresh meat	max 2 days
Fish, minced meat, seafood	max 1 day

3.7 Using the freezer compartment

To keep and freeze foods properly:

- pack fruit and vegetables in portions of no more than 2.20 oz and meat and fish in portions of up to 4.40 oz.
- small packages freeze quickly which means that the foods' nutritional properties are preserved better, including after defrosting/preparation.
- package foods in hermetically sealed packages, expelling air as much as possible.
- Do not use paper bags or shopping bags, use the suitable freezer bags/containers.



NOTE:

Always allow hot foods and drinks to cool to room temperature before putting them in the appliance.



Frozen foods storage life table

Foodstuff	Time
Fruit, beef	max 10-12 months
Vegetables, veal, poultry	max 8-10 months
Game	max 6-8 months
Pork	max 4-6 months
Mince	max 4 months
Bread, desserts, cooked foods, oily fish	max 3 months
Offal	max 2 months
Sausages, lean fish	max 1 month

Defrosted foods



CAUTION

- Do not refreeze frozen foods which have partly or completely defrosted.

Food must be consumed as soon as possible once defrosted. Freezing foods preserves them, but it does not destroy any micro-organisms, which are activated after defrosting, damaging the foods.

Partial defrosting lowers the nutritional value of the foodstuffs, particularly of fruit, vegetables and ready meals.

3.8 Noises during operation

The refrigerator and freezer compartments are cooled by means of a compression system. In order to maintain the preset temperature inside the refrigerator and freezer compartments, the compressor comes into operation in response to the level of cooling required, and may operate continuously if necessary. When the compressor starts to function, it creates a buzzing noise which generally diminishes in intensity after a few minutes.

Another normal operating noise of the appliance is a gurgling due to the coolant flowing through the pipes in the circuit. This noise is normal and does not indicate an appliance malfunction. If it becomes too loud, this may mean that there are other causes. Checks must then be made to ensure that:

- The refrigerator is properly levelled on the floor and does not vibrate when the compressor is in operation: if this is not the case, adjust the appliance's feet until it is level;
- The drawers, shelves and trays on the door are correctly positioned in their holders: if they are not, put them in correctly;
- Bottles and containers on the various shelves are stable and not touching each other: otherwise, the vibration resulting from compressor operation could generate noise;
- Do not place the refrigerator in such a way that it is in contact with furniture or other household appliances.





3.9 Heated front surface

There is a front surface heating system inside the cabinet to limit the formation of condensation around the door seal.

3.10 Turning the appliance off

Whenever the appliance is to remain unused for long periods, it should be switched off.

1. Keep the ON/OFF  button on the control panel pressed for 3 seconds. The  symbols are displayed on the refrigerator and freezer temperature displays.
2. Unplug the appliance from the wall socket.
3. Empty the compartments.
4. Once the freezer has fully defrosted, dry any residual accumulated moisture with a tea towel.



NOTE:

Leave the door ajar to ensure that moisture and stagnant air do not cause unpleasant odors.

3.11 Food storage advice

Practical energy saving advice

- Correct use of the appliance, correct packaging of foodstuffs, a constant temperature and food hygiene have significant effects on the quality of storage.
- Reduce the number of times that the doors are opened and the length of time they remain open to prevent the compartments from heating up excessively.
- Clean the condenser (rear of the appliance) periodically to prevent the appliance from losing efficiency.
- Defrost frozen food in the refrigerator compartment in order to make use of the cold stored in the frozen foods.

General advice

- Always check the expiry date on the food packaging.
- The foodstuffs must be stored in closed or pre-packaged containers and must not be able to emit or absorb moisture and odors.
- Remove perishable products from the appliance if you are going away for a long period.

Refrigerator compartment door

- Keep eggs, butter, cheese etc. in the upper and central parts.
- Keep drinks, bottles, cans etc. in the lower part.



Use

Refrigerator compartment



- Keep dairy products, ready meals, pastries, fruit juices, beer etc. in the central part.
- Keep meats, cold cuts etc. in the lower part.
- Keep fresh and tropical fruit, vegetables, root vegetables, onions, etc. in the fruit and vegetable drawer.

Freezer compartment

- The type of food, quantity and date of freezing should be marked on the container/packaging.
- Use small containers, if possible already cold.
- The quantity of fresh foods which can be frozen at the same time is listed on the nameplate inside the refrigerator compartment.
- Use suitable freezer bags, tinfoil, cling-film for use with food, and freezer containers.
- Do not use paper bags, cellophane for non-food use, shopping bags or pre-used freezer bags.
- Avoid frozen food coming into contact with fresh food to be frozen.
- Keep bagged frozen vegetables, ice, ice cream etc.

Temperature scale

This function allows you to set the temperature scale from degrees Fahrenheit (°F) to degrees Celsius (°C) and vice versa:

- Press keys  and  simultaneously for 3 seconds.
- Repeat the procedure to return to the previous temperature format.



NOTES:

After a power failure, the unit maintains the previously set temperature scale.



4 Cleaning and maintenance

4.1 Instructions

WARNING

- Turn off the appliance and unplug it from the mains before cleaning or maintenance.
- Do not pull the cable to remove the plug.
- Use nonflammable cleaner.

CAUTION

- Do not use steam jets to clean the appliance.
- Do not use cleaning products containing chlorine, ammonia or bleach on parts made of steel or that have metallic surface finishes (e.g. anodizing, nickel- or chromium-plating).
- Do not use abrasive or corrosive detergents (e.g. powder products, stain removers and metallic sponges) on glass parts.
- Do not use rough or abrasive materials or sharp metal scrapers.
- Do not clean glass shelves or covers with warm water when they are cold.
- Glass shelves and covers are heavy, use special care when removing them.

4.2 Cleaning the appliance

A special antibacterial protection on the appliance's interior walls prevents bacterial growth and keeps them clean. They must nevertheless be cleaned regularly in order to keep them in good condition.

Cleaning the outside of the appliance

- The appliance may be cleaned with water or alcohol-based liquid detergents (e.g. window cleaning products).
- Avoid aggressive detergents and rough sponges in order not to damage the surfaces.
- Use a soft brush to remove dust and fume deposits from the condenser on the rear of the appliance.
- Clean the tank above the compressor.

Cleaning the inside of the appliance

- Clean the inside of the appliance with diluted liquid detergent and warm water, adding a little bit of vinegar.
- Door balconies and shelves can be removed.
- Do not use sharp objects or spray products.



Cleaning and maintenance

4.3 Defrosting

CAUTION

- Do not use electrical appliances (e.g. hair dryers) or sprays for defrosting, the plastic parts could be damaged.



NOTE:

Occasional presence of frost inside the freezer compartment is normal.

WARNING

- Turn off the appliance and unplug it from the mains before cleaning or maintenance.
- Do not pull the cable to remove the plug.
- Use nonflammable cleaner.

Defrosting the refrigerator/freezer compartments

The refrigerator/freezer compartment does not require defrosting, as any ice which forms on the refrigeration plate will melt when the compressor is switched off. The defrosting process is automatic.

Defrost water is channeled directly into the dedicated pan on the back of the appliance, which lets it evaporate by means of the heat generated by the compressor.

4.4 Interior lighting

Interior lighting, if damaged, must be repaired by Technical Service only.

4.5 What to do if...

The appliance does not work:

- Make sure that the appliance is plugged in and that the main switch is turned on.

The compressor starts to function too often or functions continuously:

- The room temperature is too high.
- The door is being opened too often or for too long.
- The door is not closing/sealing properly.
- The freezer is loaded with too many fresh foods.
- Check that sufficient air can circulate around the sensor on the right-hand side of the refrigerator compartment.
- Check that the back of the freezer is properly ventilated and that the condenser is not too dirty.

Excessive ice or condensation has built up inside the refrigerator compartment:

- The door is being opened too often or for too long.
- Hot foods have been placed inside the refrigerator compartment.
- The foodstuffs or containers are in contact with the rear wall.
- The door seal is damaged or dirty. Clean or replace it.



The refrigerator compartment is not sufficiently cold:

- The thermostat is set at too high a temperature.
- The door is being opened too often or for too long.
- The door is not closing/sealing properly.
- The room temperature is too high.

The temperature inside the refrigerator compartment is too cold and the foodstuffs are freezing:

- The thermostat is set at too low a temperature.
- Food not contained in suitable containers or bags.
- Fruit and vegetables might be too wet.
- Foodstuffs placed against the rear wall of the refrigerator compartment.

Temperature inside freezer compartment not low enough to freeze foods properly:

- The thermostat is set at too high a temperature.
- The door is being opened too often or for too long.
- The door is not closing/sealing properly.
- The door seal is damaged or dirty. Clean or replace it.
- The food to be frozen contains large quantities of sugar.

Excessive ice has built up inside the freezer compartment:

- The thermostat is set at too low a temperature.
- The room temperature is too high.
- The door is being opened too often or for too long.
- The door is not closing/sealing properly.
- The door seal is damaged or dirty. Clean or replace it.
- Hot foods have been placed inside the freezer compartment.

Doors are hard to open just after closing:

- If you attempt to open the door again just after closing it (especially the freezer door), considerable strength is required. This is due to the vacuum created by the cooling of the warm air which has entered the freezer.

The doors are misaligned:

- Check that the appliance is level.
- Level the appliance using its feet.



Installation

5 Installation

5.1 Electrical connection

DANGER

- Non-compliance with these instructions may result in death, fire or an electric shock.

WARNING

- Plug into a grounded 3-prong outlet.
- Do not remove ground prong.
- Do not use an adapter plug.
- Do not use an extension cord.
- Do not twist or tie the power cord.
- Do not pull or bend the power cord.
- The appliance must be connected to ground in compliance with electrical system safety standards.
- Do not pull the cable to remove the plug.
- Do not damage the refrigerant circuit

General information

- Check the mains characteristics against the data indicated on the plate. The identification plate bearing the technical data, serial number and brand name is visibly positioned inside the appliance. Do not remove this plate for any reason.
- Make sure that the plug and socket are of the same type.
- The plug must always be accessible when the appliance is installed.
- Leave the appliance standing vertically for at least two hours before turning it on for the first time.

- If it is necessary to replace the power cable, **this must be performed by an authorized technician from Technical Support Service.**

5.2 Positioning

WARNING

- Keep ventilation openings, in the appliance enclosure or in the built-in structure, clear of obstruction.

CAUTION

- Never use the open door to lever the appliance into place when fitting.
- Avoid exerting too much pressure on the door when open.

Choice of location

WARNING

Do not install this appliance:

- outdoor,
- in manufactured (mobile) homes, in recreational vehicles (RVs) or boat.
- near a heater or flammable material. Keep flammable materials and vapor, such as gasoline, away from the appliance.
- in a room where there is a risk of freezing.
- in direct sunlight or exposed to heat from stoves (if this is not possible, insulate properly).



Always install the appliance in a dry place with satisfactory ventilation. Depending on its climate class (stated on the nameplate inside the refrigerator compartment), the appliance can be used in different temperature conditions.

Class	Room temperature
SN (Subnormal)	+ 50°F to + 89°F
N (Normal)	+ 61°F to + 89°F
ST (Subtropical)	+ 64°F to + 100°F
T (Tropical)	+ 64°F to + 109°F

- The appliance must not be installed near heat sources. If this is not possible, insulate properly.
- To ensure proper ventilation for your appliance allow 1 ¼" (3 cm) space on each side.
- If installed underneath wall units, at least 3" (7.6 cm) clearance must be left.
- Ensure that the appliance is located with sufficient space for the door to open and for the internal drawers and shelves to be removed, if necessary. Leave 14 ½" (36,8 cm) minimum on the hinge side to

allow for the door to swing open.

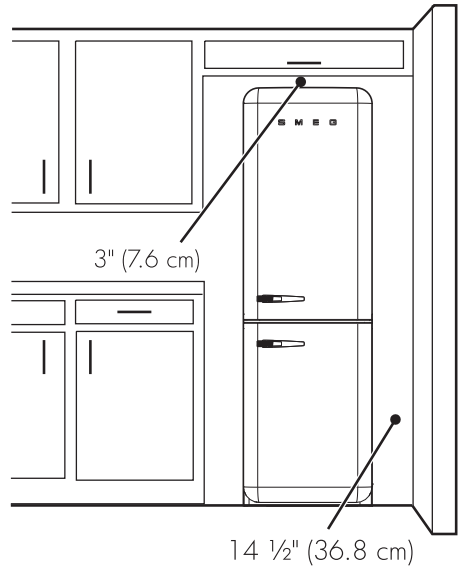

Spacers

To ensure proper cooling of the condenser, the appliance must not be placed too close to the wall. To prevent this, the appliance comes complete with two plastic spacers, which must be fitted in the rear part of the appliance.

Positioning

Position the appliance on a firm, level surface.

The appliance has two small wheels on the back to allow it to be moved and positioned more easily.

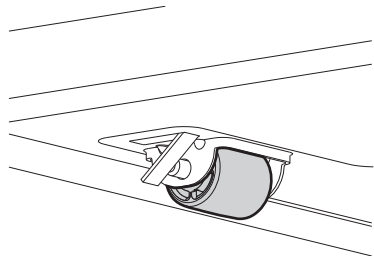



Installation

In any case, we recommend moving the appliance very carefully in order to avoid damaging the floor (especially in the case of wooden floors).

If the floor is not perfectly level, use the two adjustable feet on the front part of the appliance

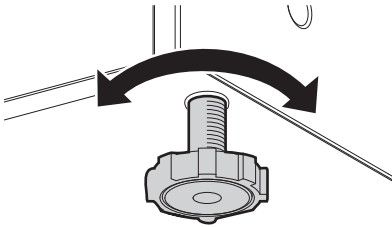

Level the appliance horizontally adjusting its feet.

Lean the appliance slightly towards the rear part to facilitate proper door closure.

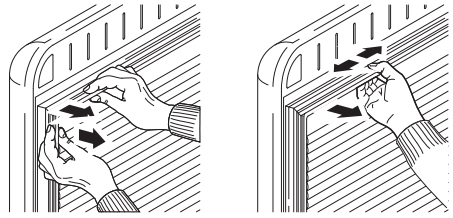
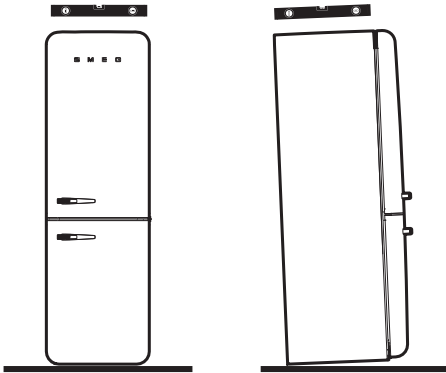

CAUTION

- Do not press, do not tear or detach the seal from the door.

A few days after installation, check that the initial level adjustment is still correct. Make sure that the appliance is still stable and the door seals still close hermetically when it is in operation and loaded with food. If necessary, re-adjust the level and the seals.



NOTE:

In order for the appliance to be installed correctly, the door must be able to close properly. Ensure that the door seals close hermetically, especially at the corners.