

# Contents

<b>1. Important safety instructions</b>	<b>4</b>
<b>2. Intended use of the appliance</b>	<b>5</b>
<b>3. General safety instructions</b>	<b>7</b>
3.1 Risk of personal injury	7
3.2 Manufacturer liability	8
3.3 Disposal	9
3.4 Identification plate	9
3.5 This user manual	9
3.6 How to read the user manual	10
<b>4. Description of the appliance</b>	<b>11</b>
4.1 General description	11
<b>5. Using the appliance</b>	<b>12</b>
5.1 Information about New Generation Cooling Technology	12
5.2 Display and Control Panel	12
5.3 Operating your Refrigerator/Freezer	12
5.4 Temperature Adjustment Warnings	14
5.5 Accessories	15
<b>6. Food storage</b>	<b>19</b>
6.1 Refrigerator Compartment	19
6.2 Freezer Compartment	20
<b>7. Cleaning and Maintenance</b>	<b>23</b>
7.1 Defrosting	23
7.2 Instructions	24
7.3 Cleaning the appliance	24
7.4 What to do if...	25
<b>8. Installation</b>	<b>27</b>
8.1 Electrical connection	27
8.2 Positioning	27
8.3 Installation warnings	28
8.4 During Usage	29
<b>9. Shipment and repositioning</b>	<b>31</b>
9.1 Transportation and Changing Positioning	31
<b>10. Before calling service</b>	<b>32</b>
<b>11. Tips for saving energy</b>	<b>35</b>

We advise you to read this manual carefully, as it contains all the instructions for maintaining the appliance's aesthetic and functional qualities.

For further information on the product: [www.smeg.com](http://www.smeg.com)



# Important safety instruction

## 1. Important safety instructions



### **READ AND SAVE THESE INSTRUCTIONS**

– Your Safety and the Safety of Others Are Very Important.

We have provided many important safety messages throughout this manual and on your appliance.

Read all instructions before using your appliance and always obey all safety messages.



### **RECOGNIZE SAFETY INFORMATION**

This is a safety alert symbol. This symbol alerts you to potential hazards that can kill or hurt you and others.

### **UNDERSTAND SIGNAL WORDS**

A signal word – **DANGER**, **WARNING**, or **CAUTION** – is used with the safety-alert symbol. **DANGER** identifies the most serious hazards. It means you can be killed or seriously injured if you do not immediately follow instructions. **WARNING** means you can be killed or seriously injured if you do not follow instructions. **CAUTION** indicates a potentially hazardous situation which, if not avoided, may result in minor or moderate injury.



## **WARNING - FOR YOUR SAFETY**

- Use this appliance only for its intended purpose as described in this Instruction Manual.
- Ensure proper installation in accordance with the Installation Instructions before using this appliance.
- Use two or more people to move and install this appliance.
- Do not climb, stand or hang on the shelves in the refrigerator. This could cause serious injury or result in damage to the refrigerator.
- Never allow children to play with the refrigerator and use the drawers, shelves and others parts of the appliance only as described in this handbook.
- This appliance is not intended for use by persons (including children) with reduced physical, sensory or mental capabilities, or lack of experience and knowledge, unless they have been given supervision or instruction concerning use of the appliance by a person responsible for their safety.
- Never store explosive or flammable substances, such as gasoline and spray bottles in or in the vicinity of this appliance or use gasoline or other flammable vapors or liquids in the vicinity of this or any other appliance. Read product labels for warnings regarding flammability and other hazards.
- **WARNING:** Do not use mechanical, electrical or chemical products to

# Important safety instruction



accelerate the defrosting process, other than those recommended by the manufacturer.

- **WARNING:** do not damage the refrigerant circuit (if can be accessed). Failure to do so can result in death, explosion or fire.
- Use a non-flammable cleaner to clean the unit.
- High alcohol content must only be stored sealed and vertical.
- Never touch frozen product straight from the freezer or put it in your mouth. This can cause burn injury due to very low temperatures.
- Unplug your refrigerator before cleaning and making repairs.

## 2. Intended use of the appliance



### DANGER - CHILD SAFETY

- This appliance is intended to be used in household and similar applications such as:
  - a) Staff kitchen areas in shops, offices and other working environments;
  - b) Clients in hotels, motels and other residential type environments;
  - c) Bed and breakfast type environments;
  - d) The appliance is not designed for professional and commercial use.
  - e) This appliance is for refrigeration and conservation of fresh and frozen foods in the home. Every other use is considered inappropriate.
  - f) The appliance is not designed to operate with external timers or with

remote-control systems.

- **CHILD ENTRAPMENT HAZARD:**

Abandoned refrigeration products are still dangerous – even if they will sit for “just a few days.” If you are disposing of your old appliance, please follow these instructions to help prevent accidents.

### Before you dispose of your old appliance:

- Remove doors;
- Leave shelves in place so children may not easily climb inside;
- Have refrigerant removed by a qualified service technician.

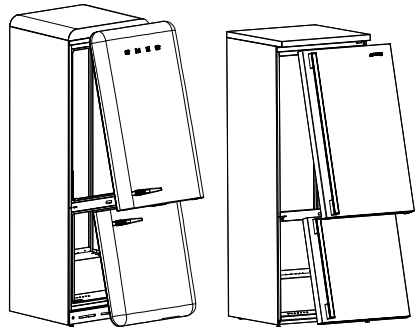

- Children should NEVER use these items to play. They can cause suffocation and death.
- Do not allow children to climb, stand or hang on the shelves in the refrigerator.
- Never allow children to play with the refrigerator.

# Important safety instruction



## ELECTRICAL INFORMATION

- To reduce the risk of fire, electric shock, or injury to persons when using this refrigerator, follow basic precautions, including the following:
- The power cord to this appliance is equipped with a three-prong grounding plug for your protection against electrical shock hazards. It must be plugged directly into a properly grounded three-prong receptacle.
- Do not, under any circumstances, cut or remove the third (ground) prong from the power cord. For personal safety, this appliance must be properly grounded.
- Have the wall outlet and circuit checked by a qualified electrician to make sure the outlet is properly grounded.
- Do not use an adapter plug.
- Do not use an extension cord.
- Never unplug an appliance by pulling on the power cord. Always grip the plug firmly and pull straight out from the outlet to prevent damaging the power cord.
- Unplug the appliance before servicing.
- **WARNING:** do not use electrical appliances inside the food storage compartments of the appliance, unless they are of the type recommended by the manufacturer.

## WARNING

- Before you dispose of your old refrigerator/freezer:
  - Pull out the power cord plug.
  - Cut off the power cord.
  - Have refrigerant removed and disposed by a qualified service technician.
  - Do not allow children to climb, stand or hang on the shelves in the refrigerator.
  - Never allow children to play with the refrigerator.



## 3. General safety instructions

### 3.1 Risk of personal injury

- Keep children under the age of eight at a safe distance unless they are constantly supervised and make sure that they do not play with the appliance.
- Never try to put out a fire or flames with water: turn off the appliance and smother the flames with a fire blanket.
- Cleaning and maintenance that should be performed by the user must not be carried out by unsupervised children.
- Have qualified personnel carry out installation and assistance interventions according to the standards in force.
- Do not modify this appliance.
- Do not insert pointed metal objects (cutlery or utensils) into the slots in the appliance.
- Do not try to repair the appliance yourself or without the intervention of a qualified technician.
- Do not touch (especially with wet hands) frozen products or put them in your mouth directly.
- If the power supply cord is damaged, contact technical support immediately and they will replace it, so as to prevent any risk.
- Opening the door for long periods can cause a significant increase of the temperature in

the compartments of the appliance.

- Clean regularly surfaces that can come in contact with food and accessible drainage systems.
- Store raw meat and fish in suitable containers in the refrigerator, so that it is not in contact with or drip onto other food.
- If the refrigerating appliance is left empty for long periods, switch off, defrost, clean, dry, and leave the door open to prevent mould developing within the appliance.

### Risk of damaging the appliance

- **WARNING:** When positioning the appliance, ensure the supply cord is not trapped or damaged.
- **WARNING:** Do not locate multiple portable socket-outlets or portable power supplies at the rear of the appliance.
- Never rest sharp metal objects such as knives, forks, spoons and lids on the appliance during use.
- Do not use abrasive or corrosive detergents (e.g. scouring products, stain removers and metallic sponges) on glass parts.
- Do not sit on the appliance.



## Instructions

- Do not pull on the door handle to move the appliance.
- Do not use steam jets to clean the appliance.
- Do not use the appliance to cool rooms for any reason.
- Always unplug the appliance in the event of a fault or when performing cleaning or maintenance.
- Do not keep liquids in tins or glass containers in the freezer.
- Do not use sharp metal objects to remove excess ice build-up in the freezer compartment.
- To prevent instability of the appliance, install and secure it correctly as indicated in the instructions provided in this manual.
- Do not place heavy objects on the top of the appliance.
- If installed near another refrigerator or freezer, keep it at a minimum distance of 1".
- Do not install/use the appliance outdoors.

### For this appliance

- **WARNING:** risk of fire /flammable materials.



- Do not rest any weight or sit on the open door of the appliance.

- Take care that no objects are stuck in the doors.
- The appliance contains a small quantity of isobutane (R600a), make sure not to damage the cooling circuit during transport, installation and cleaning.
- Keep the ventilation openings surrounding the appliance or in the nearby area free from any obstructions.
- Do not damage the cooling circuit (if it can be accessed).
- Do not use electrical appliances inside food storage compartments unless these are of the type recommended by the manufacturer.
- In the event of damage to the cooling circuit, avoid the use of open flames and ventilate the area properly.
- Do not use the appliance or parts of it in ways other than those specified in this manual.

### 3.2 Manufacturer liability

The manufacturer declines all liability for damage to persons or property caused by:

- use of the appliance other than that specified;
- failure to comply with the instructions in the user manual;
- tampering with any part of the appliance;
- use of non-original spare parts.



## 3.3 Disposal



Power voltage

### **Danger of electrocution**

- Disconnect the mains power supply.
- Unplug the appliance.
- Cut the power supply cable and remove it along with the plug.
- If the appliance is replaced, remove the door and leave the shelves in their positions, in order to prevent children from being trapped inside.

Our appliances are packaged in non-polluting and recyclable materials.

- Deliver the packing materials to the appropriate recycling centre.



Plastic packaging

### **Danger of suffocation**

- Do not leave the packaging or any part of it unattended.
- Do not let children play with the plastic bags.

## 3.4 Identification plate

The identification plate bears the technical data, serial number and brand name of the appliance. Do not remove the identification plate for any reason.

## 3.5 This user manual

This user manual is an integral part of the appliance and must therefore be kept in its entirety and within the user's reach for the whole working life of the appliance.

Read this user manual carefully before using the appliance.





# Instructions

## 3.6 How to read the user manual

This user manual uses the following reading conventions:



### **Warning**

Serious injury or death risk



### **Risk of electric shock**

Dangerous voltage risk



### **Fire**

Warning; risk of fire / flammable materials



### **Caution**

Injury or property damage risk



### **Important**

Operating the system correctly



### **Description**

Description of the appliance and its accessories.



### **Use**

Information on the use of the appliance and its accessories, food storage advice.



### **Cleaning and maintenance**

Information for proper cleaning and maintenance of the appliance



### **Installation**

Information for the qualified technician: Installation, operation and inspection.





## 4. Description of the appliance

### 4.1 General description

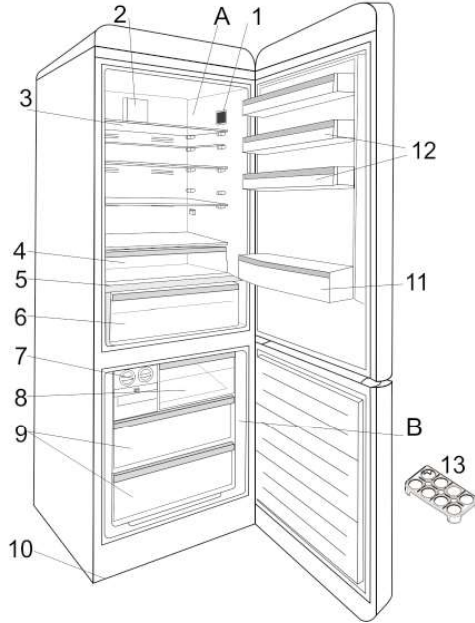

This presentation is only for information about the parts of the appliance. Parts may vary according to the appliance model.

- A) Refrigerator compartment
- B) Freezer compartment
- 1) Display and control panel
- 2) Turbo fan \*
- 3) Refrigerator shelves
- 4) Wine rack \*
- 5) Chiller \*
- 6) Crisper cover
- 7) Crisper

- 8) Icemaker \*
- 9) Freezer drawer cover \* / Upper drawer
- 10) Freezer drawers
- 11) Levelling feet (not shown)
- 12) Bottle shelf
- 13) Adjustable door shelf \* / Door shelf
- 14) Door shelves
- 15) Egg holder
- 16) Ice cube tray \*

\* In some models



## 5. Using the appliance

### 5.1 Information about New Generation Cooling Technology

Refrigerators with new-generation cooling technology have a different operating system to static fridges. Other (static) fridges may experience a build up of ice in the freezer compartment due to door openings and humidity in the food. In such refrigerators, regular de-frosting is required; the refrigerator must be switched off, the frozen food moved to a suitable container and the ice which has formed in the freezer compartment removed.

In refrigerators with new-generation cooling technology, a fan blows dry cold air evenly throughout the refrigerator and freezer compartments. The cold air cools your food evenly and uniformly, preventing humidity and ice build-up. In the refrigerator compartment, air blown by the fan, located at the top of the refrigerator compartment, is cooled while passing through the gap behind the air duct. At the same time, the air is blown out through the holes in the air duct, evenly spreading cool air throughout the refrigerator compartment.

There is no air passage between the

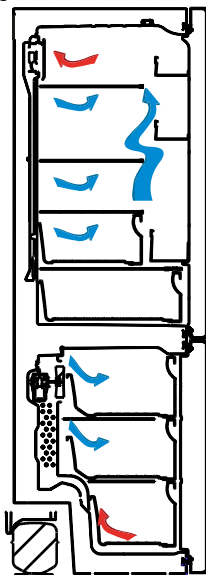

freezer and refrigerator compartments, therefore preventing the mixing of odors.

As a result, your fridge, with new generation cooling technology, provides you with ease of use as well as a huge volume and aesthetic appearance.

### 5.2 Display and Control Panel

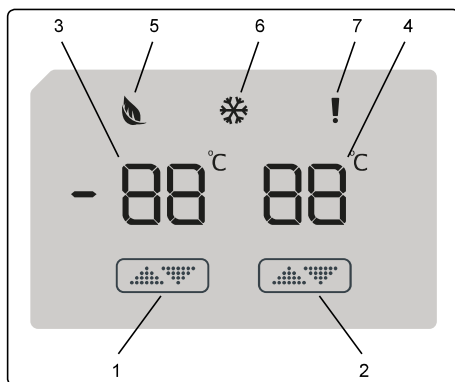

### Using the Control Panel

1. Enables the setting of the freezer.
2. Enables the setting of the refrigerator.
3. Freezer set value screen.
4. Refrigerator set value screen.
5. Economy mode symbol.
6. Super freeze symbol.
7. Alarm symbol.

### 5.3 Operating your Refrigerator/ Freezer

Once you have plugged in the unit, all symbols will be displayed for 2 seconds and the initial values will be shown as  $-0.4^{\circ}\text{F}$  on the freezer adjustment indicator, and  $+39^{\circ}\text{F}$  on the refrigerator adjustment indicator.



### 5.3.1 Freezer Temperature Settings

- The initial temperature value for the freezer setting indicator is  $-3.2^{\circ}\text{F}$ .
- Press the freezer set button once.

When you first press the button, the previous value will blink on the screen.

- Whenever you press the same button, a lower temperature will be set ( $3.2^{\circ}\text{F}$ ;  $-0.4^{\circ}\text{F}$ ;  $-4^{\circ}\text{F}$ ;  $-7.5^{\circ}\text{F}$ ;  $-11^{\circ}\text{F}$ ).
- If you continue to press the button, it will restart from  $3.2^{\circ}\text{F}$ .

**NOTE:** Eco mode gets activated automatically when the temperature of the freezer compartment is set to  $-0.4^{\circ}\text{F}$ .



### 5.3.2 Refrigerator Temperature Settings

- The initial temperature value for the refrigerator setting indicator is  $+39^{\circ}\text{F}$ .
- Press the refrigerator button once.
- Whenever you press the button, a lower temperature will be set ( $+46^{\circ}\text{F}$ ,  $+43^{\circ}\text{F}$ ,  $+41^{\circ}\text{F}$ ,  $+39^{\circ}\text{F}$ , or  $+36^{\circ}\text{F}$ ).
- If you continue to press the button, it will restart from  $+46^{\circ}\text{F}$ .

### 5.3.3 Super Freeze Mode Purpose

To freeze a large quantity of food that cannot fit on the fast freeze shelf.

To freeze prepared foods.

To freeze fresh food quickly to retain freshness.

### How to use

To enable the super freeze mode, press and hold the freezer temperature setting button for 3 seconds. Once the super freeze mode has been set, the super freeze symbol on the indicator will be lit and the machine will beep to confirm the mode has been switched on.

### During Super Freeze Mode:

- The temperature of the Refrigerator may be adjusted. In this case, Super Freeze mode will continue.
- Economy mode cannot be selected.
- Super Freeze mode can be cancelled in the same way it is selected.

### Notes:

- The maximum amount of fresh food (in kilograms) that can be frozen within 24 hours is shown on the appliance label.
- For optimal appliance performance in maximum freezer capacity, activate super freeze mode 3 hours before you put fresh food into the freezer.



Super freeze mode will automatically cancel after 24 hours or when the freezer sensor temperature drops below  $-25.5^{\circ}\text{F}$ .



## Recommended Settings for the Freezer and Refrigerator Compartment Temperature

Freezer Compartment	Refrigerator Compartment	Remarks
0.4°F	39°F	For regular use and best performance.
-4°F -7.5°F or -11°F	39°F	Recommended when environmental temperature exceeds 86°F.
Super Freeze mode	39°F	Must be used when you wish to freeze food in a short period of time.
-0.4°F -4°F -7.5°F or -11°F	36°F	These temperature settings must be used when the environmental temperature is high or if you think the refrigerator compartment is not cool enough because the door is being opened frequently.

## 5.4 Temperature Adjustment Warnings

- It is not recommended that you operate your appliance in environments colder than 50°F in terms of its efficiency.
- Do not start another adjustment while you are already making an adjustment.
- Temperature adjustments should be made according to the frequency of door openings, the quantity of food kept inside the appliance and the ambient temperature in the location of your appliance.
- In order to allow your appliance to reach the operating temperature after being connected to mains, do not open the doors frequently or place large quantities of food in the appliance. Please note that, depending on the ambient temperature, it may take 24 hours for your appliance to reach the operating temperature.
- A 5 minute delay function is applied to prevent damage to the compressor of your appliance when connecting or disconnecting to mains, or when an energy breakdown occurs. Your appliance will begin to operate normally after 5 minutes.



## 5.5 Accessories

### 5.5.1 Ice Tray (In some models)

- Fill the ice tray with water and place in the freezer compartment.
- After the water has completely frozen, you can twist the tray as shown below to remove the ice cubes.

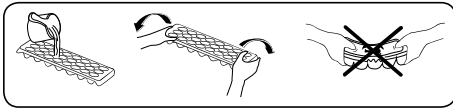

### 5.5.2 The Icemaker (In some models)

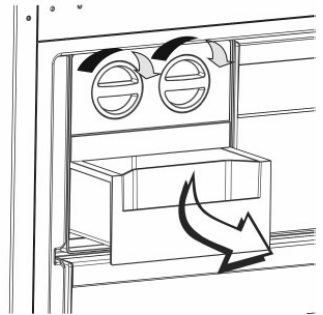
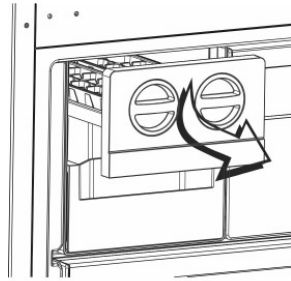

Pull the lever towards you and remove the icemaker tray

- Fill with water to the marked level
- Hold the left end of the lever and set the ice-tray on the icebox
- When ice cubes have formed, twist the lever to drop the ice cubes into the icebox.



**Do not fill the icebox with water in order to make ice. It will break.**



## Use

### 5.5.3 The Freezer Bin

The freezer bin allows food to be accessed more easily.

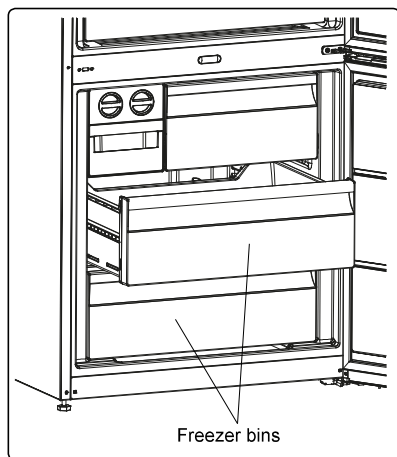

Removing the freezer bin:

- Pull the bin out as far as possible
- Pull the front of the bin up and out



Carry out the opposite of this operation when refitting the sliding compartment.



Always keep hold of the handle of the bin while removing it.

### 5.5.4 The Chiller Bin (In some models)

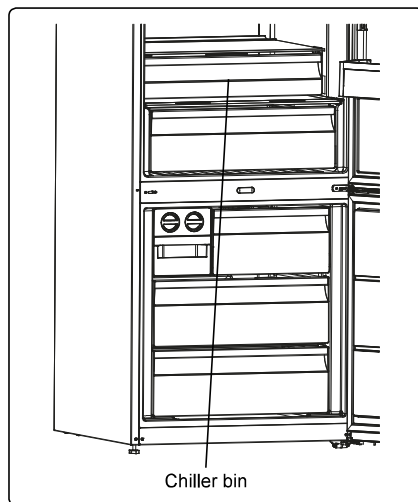

Keeping food in the Chiller compartment, instead of the freezer or refrigerator compartments, allows food to retain freshness and flavour for longer, while preserving its fresh appearance. When the Chiller bin becomes dirty, remove it and wash with water.

(Water freezes at 32°F, but food containing salt or sugar freezes at temperatures lower than this).

The Chiller bin is usually used for storing foods such as raw fish, lightly pickled food, rice, and so on.



**Do not put food you want to freeze or ice trays (to make ice) in the Chiller bin.**



## To remove the Chiller Shelf:

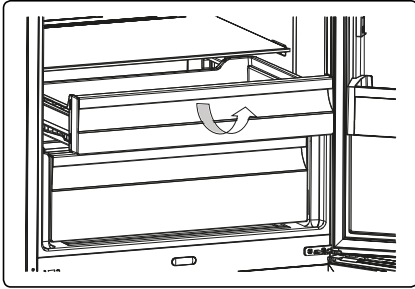

- Pull the chiller shelf towards you by sliding it on the rails.
- Pull the chiller shelf up from the rail and remove it from the refrigerator.

## 5.5.5 The Fresh Dial (In some models)

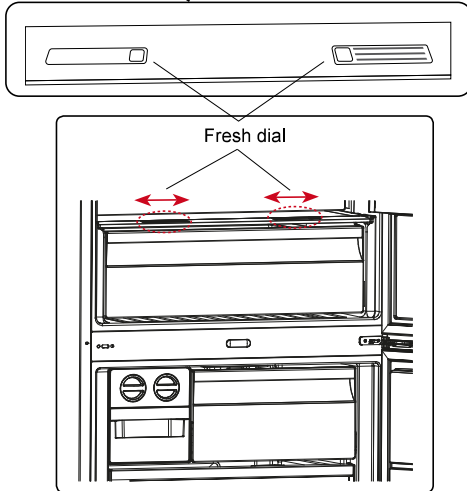

If the crisper is full, the fresh dial located in front of the crisper should be opened.

This allows the air in the crisper and the humidity rate to be controlled, to increase the life of food within. The dial, located behind the shelf, must be

opened if any condensation is seen on the glass shelf.

## 5.5.6 Adjustable Door Shelf (In some models)

Six different height adjustments can be made to provide storage areas that you need by adjustable door shelf. To change the position of adjustable door shelf:

Hold the bottom of the shelf and pull the buttons on the side of the door shelf direction of arrow. (Fig. 1)

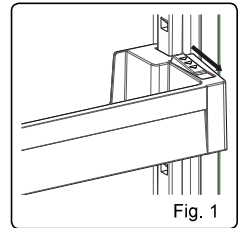

Fig. 1

Position door shelf the height you need by moving up and down. After you get the position that you want the door shelf, release the buttons on the side of the door shelf (Fig. 2)

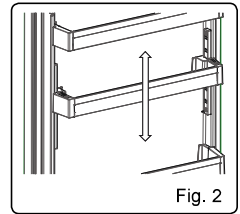

Fig. 2

Before releasing the door shelf, move up down and make sure the door shelf is fixed.

**Note:** Before moving door shelf is loaded, you must hold the shelf by supporting the bottom. Otherwise, door shelf could fall off the rails due to the weight. So damage may occur on the door shelf or rails.



## Use

### 5.5.7 Adjustable Glass Shelf (In some models)

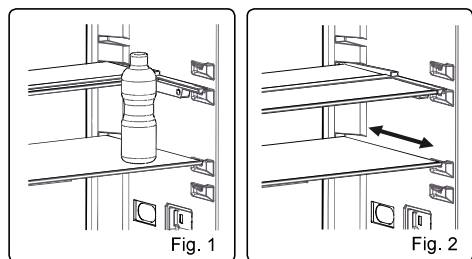

Adjustable glass shelf mechanism provides higher storage spaces with a simple movement. To cover the glass shelf, push it.

You can load your food as you want in the resulting extra space. To bring the shelf in its original position, pull it toward you.

### 5.5.8 Maxi-fresh preserver (If available)

Maxi Fresh Preserver technology helps to remove unpleasant odors from the crisper. In this way, food stays fresh for a longer time.

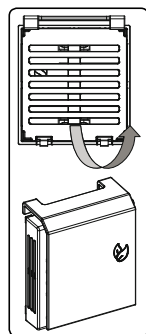

- Maxi Fresh Preserver must be cleaned once in a year. The filter should be left for 2 hours at 149°F in a oven.
- To clean the filter, please remove the back cover of the filter box by pulling it in the direction of the arrow.
- The filter should not be washed with water or any detergent.

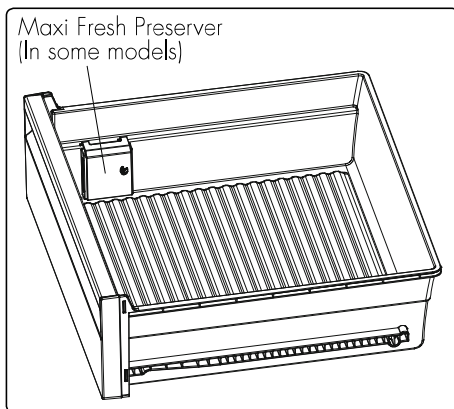

**Visual and text descriptions in the accessories section may vary according to the model of your appliance.**





## 6. Food storage

### 6.1 Refrigerator Compartment

For normal operating conditions, set the temperature of the refrigerator compartment to +39 or +43 °F.

- To reduce humidity and avoid the consequent formation of frost, always store liquids in sealed containers in the refrigerator. Frost tends to concentrate in the coldest parts of the evaporating liquid and, in time, your appliance will require more frequent defrosting.
- Never place warm food in the refrigerator. Warm food should be allowed to cool at room temperature and should be arranged to ensure adequate air circulation in the refrigerator compartment.
- Make sure no items are in direct contact with the rear wall of the appliance as frost can develop and packaging will stick to it. Do not open the refrigerator door frequently.
- We recommend that meat and clean fish are loosely wrapped and stored on the glass shelf just above the vegetable bin where the air is cooler, as this provides the best storage conditions.
- Store loose fruit and vegetable items in the crisper containers.
- Store loose fruit and vegetables in the crisper.
- Storing fruit and vegetables separately.
- Do not put wet vegetables into the refrigerator.
- Storage time for all food products depends on the initial quality of the food and an uninterrupted refrigeration cycle before refrigerator storage.

- To avoid cross-contamination do not store meat products with fruit and vegetables. Water leaking from meat may contaminate other products in the refrigerator. You should package meat products and clean any leakages on the shelves.
- Do not put food in front of the air flow passage.
- Consume packaged foods before the recommended expiry date.

 **Note:** Potatoes, onions and garlic should not be stored in the refrigerator. The table below is a quick guide to show you the most efficient way to store the major food groups in your refrigerator compartment.

Food	Maximum storage time	How and where to store
Vegetables and fruits	1 week	Vegetable bin
Meat and fish	2 - 3 Days	Wrap in plastic foil, bags, or in a meat container and store on the glass shelf
Fresh cheese	3 - 4 Days	On the designated door shelf
Butter and margarine	1 week	On the designated door shelf
Bottled products e.g. milk and yogurt	Until the expiry date recommended by the producer	On the designated door shelf
Eggs	1 month	On the designated egg shelf
Cooked food		All shelves



## 6.2 Freezer Compartment

For normal operating conditions, set the temperature of the freezer compartment to  $-0.4^{\circ}\text{F}$  or  $-68^{\circ}\text{F}$ .

- The freezer is used for storing frozen food, freezing fresh food, and making ice cubes.
- For freezing fresh food; wrap and seal fresh food properly, that is the packaging should be air tight and shouldn't leak.
- Special freezer bags, aluminum foil polythene bags and plastic containers are ideal.
- Do not store fresh food next to frozen food as it can thaw the frozen food.
- Before freezing fresh food, divide it into portions that can be consumed in one sitting.
- Consume thawed frozen food within a short period of time after defrosting
- Never place warm food in the freezer compartment as it will thaw the frozen food.
- Always follow the manufacturer's instructions on food packaging when storing frozen food. If no information is provided food, should not be stored for more than 3 months from the date of purchase.
- When purchasing frozen food, make sure that it has been stored under appropriate conditions and that the packaging is not damaged.
- Frozen food should be transported in appropriate containers and placed in the freezer as soon as possible.
- Do not purchase frozen food if the packaging shows signs of humidity and abnormal swelling. It is probable that it has been stored at an unsuitable temperature and that the contents have

deteriorated.

- The storage life of frozen food depends on the room temperature, the thermostat setting, how often the door is opened, the type of food, and the length of time required to transport the product from the shop to your home. Always follow the instructions printed on the packaging and never exceed the maximum storage life indicated.
- The maximum amount of fresh food (in lb) that can be frozen in 24 hours is indicated on the appliance label.
- To use the maximum capacity of the freezer compartment, use the glass shelves for the upper and middle section, and use the lower basket for the bottom section.
- Use the fast freezing shelf to freeze home cooking (and any other food which needs to be frozen quickly) more quickly because of the freezing shelf's greater freezing power. Fast freezing shelf is the bottom drawer of the freezer compartment.

**Note:** If you attempt to open the freezer door immediately after closing it, you will find that it will not open easily. This is normal. Once equilibrium has been reached, the door will open easily.

### **Important note:**

- Never refreeze thawed frozen food.
- The storage time of food is dependent on the type of oil used. Suitable oils are margarine, calf fat, olive oil and butter. Unsuitable oils are peanut oil and pig fat.
- Food in liquid form should be frozen in plastic cups and other food should be frozen in plastic folios or bags.



The table below is a quick guideline to show you the most efficient way to store the major food groups in your freezer compartment.

Meat and fish	Preparation	Maximum storage time (months)
Steak	Wrap in foil	6 - 8
Lamb meat	Wrap in foil	6 - 8
Veal roast	Wrap in foil	6 - 8
Veal cubes	In small pieces	6 - 8
Lamb cubes	In pieces	4 - 8
Minced meat	In packaging with-out using spices	1 - 3
Giblets (pieces)	In pieces	1 - 3
Bologna sausage/salami	Should be kept packaged even if it has a membrane	
Chicken and turkey	Wrap in foil	4 - 6
Goose and duck	Wrap in foil	4 - 6
Deer, rabbit, wild boar	In 5.5 lb portions or as fillets	6 - 8
Freshwater fish (Salmon, Carp, Crane, Catfish)	After cleaning the bowels and scales of the fish, wash and dry it. If necessary, remove the tail and head.	2
Lean fish (Bass, Turbot, Flounder)		4
Fatty fishes (Tuna, Mackerel, Bluefish, Anchovy)		2 - 4

Shellfish	Clean and in a bag	4 - 6
Caviar	In its packaging, or in an aluminium or plastic container	2 - 3
Snails	In salty water, or in an aluminium or plastic container	3



**Note:** Thawed frozen meat should be cooked as fresh meat. If the meat is not cooked after defrosting, it must not be re-frozen.



## Use

Vegetables and Fruits	Preparation	Maximum storage time (months)
String beans and beans	Wash, cut into small pieces and boil in water	10 - 13
Beans	Hull, wash and boil in water	12
Cabbage	Clean and boil in water	6 - 8
Carrot	Clean, cut into slices and boil in water	12
Pepper	Cut the stem, cut into two pieces, remove the core and boil in water	8 - 10
Spinach	Wash and boil in water	6 - 9
Cauliflower	Remove the leaves, cut the heart into pieces and leave it in water with a little lemon juice for a while	10 - 12
Eggplant	Cut into pieces of 2cm after washing	10 - 12
Corn	Clean and pack with its stem or as sweet corn	12
Apple and pear	Peel and slice	8 - 10
Apricot and Peach	Cut into two pieces and remove the stone	4 - 6
Strawberry and Blackberry	Wash and hull	8 - 12

Vegetables and Fruits	Preparation	Maximum storage time (months)
Cooked fruits	Add 10 % of sugar to the container	12
Plum, cherry, sourberry	Wash and hull the stems	8 - 12

Food	Maximum storage time (months)	Thawing time at room temperature (hours)	Thawing time in oven (minutes)
Bread	4 - 6	2 - 3	4-5 (428-437 °F)
Biscuits	3 - 6	1 - 1,5	5-8 (374-392 °F)
Pastry	1 - 3	2 - 3	5-10 (392-437 °F)
Pie	1 - 1,5	3 - 4	5-8 (374-392 °F)
Phyllo dough	2 - 3	1 - 1,5	5-8 (374-392 °F)
Pizza	2 - 3	2 - 4	15-20 (392 °F)



Dairy products	Preparation	Maximum storage time (months)	Storage conditions
Packet (Homogenized) Milk	In its own packet	2 - 3	Pure Milk – in its own packet
Cheese - excluding white cheese	In slices	6 - 8	Original packaging may be used for short-term storage. Keep wrapped in foil for longer periods.
Butter, margarine	In its packaging	6	

## 7. Cleaning and Maintenance

### 7.1 Defrosting



Occasional presence of frost inside the freezer compartment is normal.



Do not use electrical appliances (e.g. hair dryers) or sprays for defrosting, the plastic parts could be damaged.

#### Defrosting the refrigerator/freezer compartments

The refrigerator/freezer compartment does not require defrosting, as any ice which forms on the refrigeration plate will melt when the compressor is switched off. The defrosting process is automatic.

Defrost water is channelled directly into the vaporisation container on the back of the appliance, which lets it evaporate by means of the heat generated by the compressor.



# Cleaning and Maintenance

## 7.2 Instructions



Improper use  
**Risk of damage to surfaces**

- Do not use steam jets to clean the appliance.
- Do not use cleaning products containing chlorine, ammonia or bleach on parts made of steel or that have metallic surface finishes (e.g. anodizing, nickel or chromium-plating).
- Do not use abrasive or corrosive detergents (e.g. scouring products, stain removers and metallic sponges) on glass parts.
- Do not use rough or abrasive materials or sharp metal scrapers.



Power voltage  
**Danger of electrocution electrical shock**

- Turn off the appliance and unplug it from the mains before cleaning or maintenance
- Do not pull the cable to remove the plug.
- After washing, rinse with clean water and dry carefully. When you have finished cleaning, reconnect the plug to the mains supply with dry hands.

## 7.3 Cleaning the appliance



Do not wash your appliance by pouring water on it.

### Cleaning the outside of the appliance

- The appliance may be cleaned with water or alcohol-based liquid detergents (e.g. window cleaning products).
- Avoid aggressive detergents and rough sponges in order not to damage the surfaces.
- Use a soft brush to remove dust and fume deposits from the condenser on the rear of the appliance.
- Clean the condenser with a brush at least twice a year. This will help you to save on energy costs and increase productivity.



**The power supply must be disconnected during cleaning.**

### Cleaning the inside of the appliance

- Clean the inside of the appliance with diluted liquid detergent and warm water, adding a little bit of vinegar.
- Make sure that no water enters the lamp housing and other electrical components.
- Door balconies and shelves can be removed.
- Clean the accessories separately by hand with soap and water. Do not wash accessories in a dish washer.
- Do not use sharp objects or spray products.
- 
- 
- 
- 
-



## Replacing LED Lighting



To replace any of the LEDs, please contact the nearest Authorised Service Centre.

**Note:** The numbers and location of the LED strips may change according to the model.

## 7.4 What to do if...

The appliance does not work:

- Make sure that the appliance is plugged in and that the main switch is turned on.

### **The compressor starts to function too often or functions continuously:**

- The room temperature is too high.
- The door is being opened too often or for too long.
- The door is not closing/sealing properly.
- The freezer is loaded with too many fresh foods.
- Check that sufficient air can circulate around the sensor on the right-hand side of the refrigerator compartment.
- Check that the back of the freezer is properly ventilated and that the condenser is not too dirty.

### **Excessive ice or condensation has built up inside the refrigerator compartment:**

- The door is being opened too often or for too long.
- Hot foods have been placed inside the refrigerator compartment.
- The foodstuffs or containers are in contact with the rear wall.
- The door seal is damaged or dirty. Clean or replace it.

### **The refrigerator compartment is not sufficiently cold:**

- The thermostat is set at too high a temperature.
- The door is being opened too often or for too long.
- The door is not closing/sealing properly.
- The room temperature is too high.



# Installation

## **The temperature inside the refrigerator compartment is too cold and the food-stuffs are freezing:**

- The thermostat is set at too low a temperature.
- Food not contained in suitable containers or bags.
- Fruit and vegetables might be too wet.
- Foodstuffs placed against the rear wall of the refrigerator compartment.

## **Temperature inside freezer compartment not low enough to freeze foods properly:**

- The thermostat is set at too high a temperature.
- The door is being opened too often or for too long.
- The door is not closing/sealing properly.
- The door seal is damaged or dirty. Clean or replace it.
- The food to be frozen contains large quantities of sugar.

## **Excessive ice has built up inside the freezer compartment:**

- The thermostat is set at too low a temperature.
- The room temperature is too high.
- The door is being opened too often or for too long.
- The door is not closing/sealing properly.
- The door seal is damaged or dirty. Clean or replace it.
- Hot foods have been placed inside the freezer compartment.

## **Doors are hard to open just after closing:**

- If you attempt to open the door again just after closing it (especially the freezer door), considerable strength is required. This is due to the vacuum created by the cooling of the warm air which has entered the freezer.

## **The doors are misaligned:**

- Check that the appliance is level.
- Level the appliance using its feet.





## 8. Installation



**Excessive Weight Hazard.**  
**Use two or more people to move and install absorption minibar.**  
**Failure to do so can result in back or other injury.**

### 8.1 Electrical connection



Power voltage  
**Danger of electrocution or electrical shock**

- The appliance must be connected to ground in compliance with electrical system safety standards.
- Do not pull the cable to remove the plug.

### General information

- Check the mains characteristics against the data indicated on the plate. The identification plate bearing the technical data, serial number and brand name is visibly positioned inside the appliance.  
Do not remove this plate for any reason.
- Make sure that the plug and socket are of the same type.
- Do not use adapters, gang sockets or extension cords as these could cause overheating and a risk of burns.
- The plug must always be accessible when the appliance is installed.
- Leave the appliance standing vertically for at least two hours before turning it on for the first time.
- If it is necessary to replace the power cable, this must be performed by an authorised technician from Technical Support Service.

### 8.2 Positioning



Heavy appliance  
**Crushing hazard**

- Position the appliance with the aid of a second person.



Pressure on the open door  
**Risk of damage to the appliance**

- Never use the open door to lever the appliance into place when fitting.
- Avoid exerting too much pressure on the door when open.
- The appliance must not be exposed to direct sunlight.
- The appliance must not be placed near sources of heat. If this is not possible, a suitable insulation panel must be used.
- Do not use the appliance outdoors.

### Choice of location

Always install the appliance in a dry place with satisfactory ventilation.

- The appliance must not be installed near heat sources. If this is not possible, suitable insulation must be used.
- If installed underneath wall units, at least 2" clearance must be left.
- Ensure that the appliance is located with sufficient space for the door to open and for the internal drawers and shelves to be removed, if necessary.



# Installation

## Important installation instructions

This appliance is designed to work in difficult climate conditions and is powered with 'Freezer Shield' technology which ensures that the frozen food in the freezer will not defrost even if the ambient temperature falls as low as  $-59^{\circ}\text{F}$ . So you may then install your appliance in an unheated room without having to worry about frozen food in the freezer being spoilt. When the ambient temperature returns to normal, you may continue using the appliance as usual.

## 8.3 Installation warnings

Before using your appliance for the first time, please pay attention to the following points:

- The plug must be accessible after installation.
- Your appliance may have an odour when it is operated for the first time. This is normal and the odour will fade when your appliance starts to cool.
- Before connecting your appliance, ensure that the information on the data plate (voltage and connected load) matches that of the mains electricity supply. If in doubt, consult a qualified electrician.
- Insert the plug into a socket with an efficient ground connection. If the socket has no ground contact or the plug does not match, consult a qualified electrician for assistance.
- The appliance must be connected with a properly installed fused socket. The power supply (AC) and voltage at the operating point must match with the details on the name plate of the appliance (the name plate is located on the inside left of the appliance).
- We do not accept responsibility for any damages that occur due to ungrounded usage.
- Place your appliance where it will not be exposed to direct sunlight.
- Your appliance must never be used outdoors or exposed to rain.
- Your appliance must be at least  $19^{3/4}$ " away from stoves, gas ovens and heater cores, and at least 2" away from electrical ovens.
- If your appliance is placed next to a deep freezer, there must be at least  $3/4$ " between them to prevent humidity forming on the outer surface.
- Do not place heavy items on the appliance.
- Clean the appliance thoroughly before use (see Cleaning and Maintenance).
- Behind the appliance, in the lower part are the spacers that determine the minimum distance from the rear wall.
- The distance between the appliance and back wall must be a maximum of 3".
- Depending on its climate class, the appliance can be used in different temperature conditions. The climate class is specified on the nameplate of the appliance.



## 8.4 During Usage

- Do not connect your appliance to the mains electricity supply using an extension lead.
- Do not use damaged, torn or old plugs.
- Do not pull, bend or damage the cord.
- Do not use plug adapter.
- This appliance is designed for use by adults. Do not allow children to play with the appliance or hang off the door.
- Never touch the power cord/plug with wet hands. This may cause a short circuit or electric shock.
- Do not place glass bottles or cans in the ice-making compartment as they will burst when the contents freeze.
- Do not place explosive or flammable material in your refrigerator. Place drinks with high alcohol content vertically in the refrigerator compartment and make sure their tops are tightly closed.
- When removing ice from the ice-making compartment, do not touch it. Ice may cause frost burns and/or cuts.
- Do not touch frozen goods with wet hands. Do not eat ice-cream or ice cubes immediately after they are removed from the ice-making compartment.
- Do not re-freeze thawed frozen food. This may cause health issues such as food poisoning.

## • Old and Out-of-order Fridges

- If your old fridge or freezer has a lock, break or remove the lock before discarding it, because children may get trapped inside it and may cause an accident.
- Old fridges and freezers contain isolation material and refrigerant with CFC. Therefore, take care not to harm environment when you are discarding your old fridges.

## Disposal of your old appliance

The symbol on the product or on its packaging indicates that this product may not be treated as household waste.



Instead it shall be handed over to the applicable collection point for the recycling of electrical and electronic equipment. By ensuring this product is disposed of correctly, you will help prevent potential negative consequences for the environment and human health, which could otherwise be caused by inappropriate waste handling of this product. For more detailed information about recycling of this product, please contact your local city office, your household waste disposal service or the shop where you purchased the product.



# Installation

## Packaging and the Environment

Packaging materials protect your unit from damage that may occur during transportation.



The packaging materials are environmentally friendly as they are recyclable. The use of recycled material reduces raw material consumption and therefore decreases waste production.

### Notes:

- Please read the instruction manual carefully before installing and using your appliance. We are not responsible for the damage occurred due to misuse.
- Follow all instructions on your appliance and instruction manual, and keep this manual in a safe place to resolve the problems that may occur in the future.
- This appliance is produced to be used in homes and it can only be used in domestic environments and for the specified purposes. It is not suitable for commercial or common use. Such use will cause the warranty of the appliance to be void and our company will not be responsible for the losses to be occurred.
- This appliance is produced to be used in houses and it is only suitable for cooling / storing foods. It is not suitable for commercial or common use and/or for storing substances except for food. Our company is not responsible for the losses to be occurred in the contrary case. The warranty will be void.

## Positioning

Position the appliance on a firm, level surface.

The appliance has two small wheels on the back to allow it to be moved and positioned more easily.

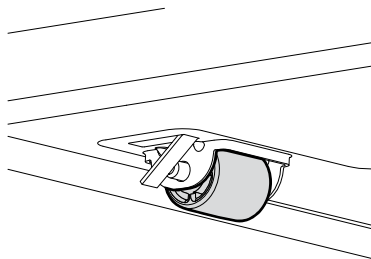

In any case, we recommend moving the appliance very carefully in order to avoid damaging the floor (especially in the case of wooden floors).

If the floor is not perfectly level, use the two adjustable feet on the front part of the appliance

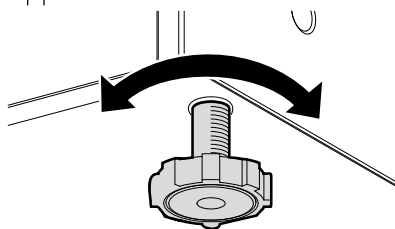

Level the appliance horizontally adjusting its feet.

Lean the appliance slightly towards the rear part to facilitate proper door closure.

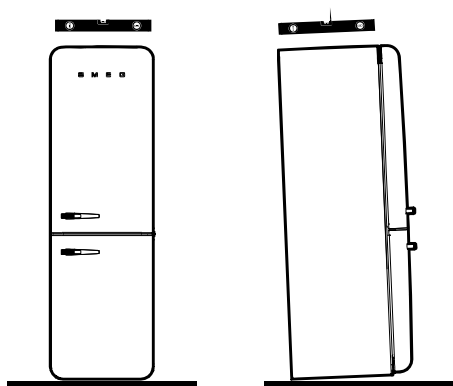

## 9. Shipment and repositioning

### 9.1 Transportation and Changing Positioning

- The original packaging and foam may be kept for re-transportation (optional).
- Fasten your appliance with thick packaging, bands or strong cords and follow the instructions for transportation on the packaging.
- Remove all movable parts (shelves, accessories, vegetable bins, and so on) or fix them into the appliance against shocks using bands when re-positioning or transporting.



Always carry your appliance in the upright position.



In order for the freezer to be installed correctly, the door must be able to close properly. Ensure that the door seals close hermetically, especially at the corners.

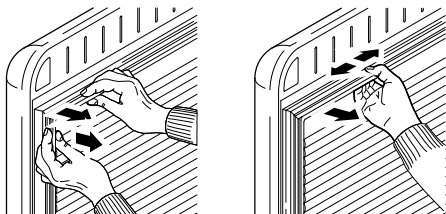

Pressure on the seal  
**Risk of damage to the appliance**

- Do not press, do not tear or detach the seal from the door.

A few days after installation, check that the initial level adjustment is still correct. Make sure that the appliance is still stable and the door seals still close hermetically when it is in operation and loaded with food.

If necessary, re-adjust the level and the seals.

## 10. Before calling service

### Errors

Your appliance will warn you if the temperatures for the appliance and freezer

are at improper levels or if a problem occurs with the appliance. Warning codes are displayed in the freezer and refrigerator indicators.

ERROR TYPE	MEANING	WHY	WHAT TO DO
E01	Sensor warning		Call Service for assistance as soon as possible.
E02	Sensor warning		Call Service for assistance as soon as possible.
E03	Sensor warning		Call Service for assistance as soon as possible.
E06	Sensor warning		Call Service for assistance as soon as possible.
E07	Sensor warning		Call Service for assistance as soon as possible.
E08	Low Voltage Warning	Power supply to the device has dropped to below 170 V.	-This is not a device failure, this error helps to prevent damages to the compressor.
			If this warning continues, contact Smeg Service.
E09	Freezer compartment is not cold enough	Likely to occur after long term power failure.	1. Set the freezer temperature to a colder value or set Super Freeze. This should remove the error code once the required temperature has been reached. Keep doors closed to improve time taken to reach the correct temperature.
			2. Remove any products which have thawed/de-frosted during this error. They can be used within a short period of time.
			3. Do not add any fresh produce to the freezer compartment until the correct temperature has been reached and the error is no longer.
			If this warning continues, contact Smeg Service.

ERROR TYPE	MEANING	WHY	WHAT TO DO
E10	Refrigerator compartment is not cold enough	Likely to occur after:	1. Set the refrigerator temperature to a colder value or set Super Cool. This should remove the error code once the required temperature has been reached. Keep doors closed to improve time taken to reach the correct temperature.
		-Long term power failure.	2. Please empty the location at the front area of air duct channel holes and avoid putting food close to the sensor.
		-Hot food has been left in the fridge.	If this warning continues an authorised technician needs to be contacted.
E11	Refrigerator compartment is too cold	Various	1. Check is Super Cool mode is activated
			2. Reduce the refrigerator compartment temperature
			3. Check to see if vents are clear and not clogged
			If this warning continues, contact Smeg Service.

If you are experiencing a problem with your refrigerator, please check the following before contacting the after-sales service.

**Your refrigerator does not operate**

**Check if:**

Your unit is plugged in and switched on  
The fuse has blown

Is the temperature adjustment right?

The socket is faulty. To check this, plug another working appliance into the same socket.

**Your refrigerator is performing poorly**

**Check if:**

The appliance is overloaded  
The doors are closed properly  
There is any dust on the condenser  
There is an adequate distance between the appliance and surrounding walls

**Your refrigerator is operating noisily**

The following noises can be heard during normal operation of the appliance.

**Cracking (ice cracking) noise occurs:**

During automatic defrosting.

When the appliance is cooled or warmed (due to expansion of appliance material).

**Clicking noise occurs:** When the thermostat switches the compressor on/ off.

**Motor noise:** Indicates the compressor is operating normally. The compressor may cause more noise for a short time when it is first activated.

**Bubbling noise and splashing occurs:**

Due to the flow of the refrigerant in the tubes of the system.

**Water flowing noise occurs:** Due to water flowing to the evaporation container. This noise is normal during defrosting.

**Air blowing noise occurs:** During normal operation of the system due to the circulation of air. There is a build-up of humidity inside the refrigerator.

### **Check if:**

- All food is packed properly. Containers must be dry before being placed in the refrigerator.
- The refrigerator doors are opened frequently.  
Humidity of the room will enter the fridge each time the doors are opened. Humidity increases faster if the doors are opened frequently, especially if the humidity of the room is high.
- There is a build-up of water droplets on the rear wall. This is normal after automatic defrosting (in Static Models).

### **The doors are not opening or closing properly Check if:**

- There is food or packaging preventing the door from closing
- The door compartments, shelves and drawers are placed properly
- The door gaskets are broken or torn
- Your appliance is level.

### **The edges of the appliance in contact with the door joint are warm**

Especially during summer (warm weather), the surfaces in contact with the door joint may become warmer during operation of the compressor. This is normal.

### **Important Notes:**

- In the case of a power failure, or if the appliance is unplugged and plugged in again, the gas in the cooling system of your refrigerator will destabilise, causing the compressor protective thermal element to open. Your refrigerator will start to operate normally after 5 minutes.
- If the appliance will not be used for a long period of time (such as during holidays), disconnect the plug. Defrost and clean the refrigerator, leaving the door open to prevent the formation of mildew and odour.
- If the problem persists after you have followed all the instructions above, please consult Smeg Service.
- This appliance is designed for domestic use and for the stated purposes only. It is not suitable for commercial or common use. If the consumer uses the appliance in a way that does not comply with these instructions, we emphasise that the manufacturer and the dealer will not be responsible for any repair or failure within the warranty period.



## 11. Tips for saving energy

1. Install the appliance in a cool, well-ventilated room, but not in direct sunlight and not near a heat source (such as a radiator or oven) otherwise an insulating plate should be used.
2. Allow warm food and drinks to cool before placing them inside the appliance.
3. Place thawing food in the refrigerator compartment. The low temperature of the frozen food will help cool the refrigerator compartment while the food is thawing. This will save energy. Frozen food left to thaw outside of the appliance will result in a waste of energy.
4. Drinks or other liquids should be covered when inside the appliance. If left uncovered, the humidity inside the appliance will increase, therefore the appliance uses more energy. Keeping drinks and other liquids covered helps preserve their smell and taste.
5. Avoid keeping the doors open for long periods and opening the doors too frequently as warm air will enter the appliance and cause the compressor to switch on unnecessarily often.
6. Keep the covers of the different temperature compartments (such as the crisper and chiller) closed.
7. The door gasket must be clean and pliable. Replace gaskets if worn.