

FAB50URCR3



Product family	Refrigerator
Installation	Free-standing
Category	Top-mount
Cooling type	Total no-frost - Dual-flow cooling system
Defrost	Automatic
Hinge position	Right
EAN code	8017709311179



Aesthetic



Aesthetics	Retro-style	Side color	Cream
Color	Cream	Logo	Applied
Finishing	Glossy	Door shelf profile color	Silver
Handle	External	Drawers profile color	Silver
Handle color	Chromed	Glass shelf profile color	Chromed
Logo color	Chromed	Display	LED
Side material	Steel	Display position	Internal

Refrigerator compartment features



No. of adjustable shelves	2	Type of crisper cover	Glass
Number of fruit and vegetables drawers	1	LifePlus zone - 32°F	Yes
Type of adjustable shelves	Glass	Refrigerator lighting	LED
Crisper cover	Yes		

Refrigerator Inner Door

Number of adjustable door shelves	3	No. of bottle shelves	1
-----------------------------------	---	-----------------------	---

Other Refrigerator features

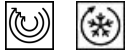

MultiFlow

Yes

Fan

Yes

Freezer features

No. of shelves

1

Freezer lighting

Yes

Freezer lighting

LED

Shelf type

Glass

Freezer Inner Door

No. of adjustable door shelves

2

Other Freezer features



Ice-maker

Yes

Ice maker

Automatic

Fast-freezing compartment

Yes

Other technical features



Display functions

Fast-freezing button

Door open alarm

Temperature setting type

No. of compressors

Refrigerant gas type

Compressor type

Foam agent

Fast-freezing, ECO, Temperature alarm

Yes

Acoustic and visual

Electronic

1

R600a

Inverter

Cyclopentane

Performance / Energy Label NEW

Annual energy consumption

453 KWh/year

Freezer volume

4.38 cu. ft.

Total volume

19.28 cu. ft.

Noise level

41 dB(A) re 1 pW

Refrigerator volume

14.90 cu. ft.

Climatic class

SN, N, ST, T

Electrical Connection

Plug

(A) USA & Mexico

Voltage (V)







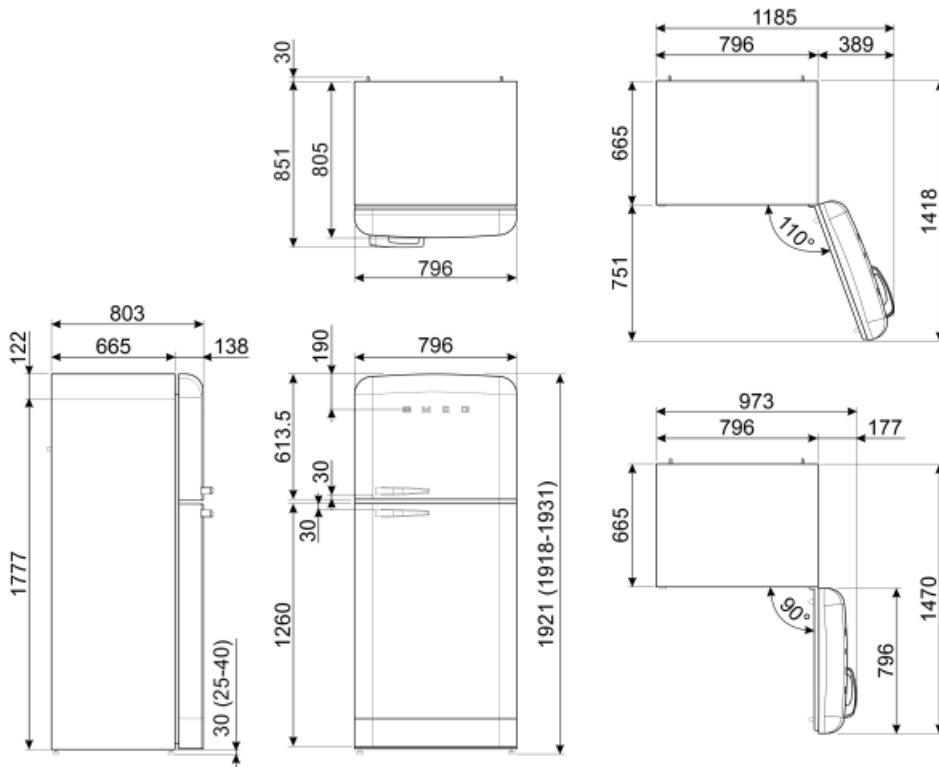



120 V

Electrical connection rating 197 W
Current 2,6 A

Frequency (Hz) 60 Hz
Power cord length 70 7/8 "



Symbols glossary (TT)

	4 stars freezing compartment for better food preservation.		The automatic defrost system works by automatically defrosting at regular intervals eliminating the need to defrost altogether.
	LED display: to show programmes, functions and options selected and the time to the end of the cycle.		Economical mode: Analyzes fridge functioning during the activation and optimizes the operating cycle in order to reduce power consumption.
	Ventilated: Forced distribution of cold air in the refrigerator compartment, which allows even temperature distribution within the fridge.		Fast freezing: The fast freezing function brings the temperature of the compartment down when activated a few hours prior to usage.
	LED interior lighting: is a more energy efficient and long lasting way of illuminating the interior of the appliance.		Life Plus 0°C: The temperature in the Lifeplus compartments is kept at 0°C, which preserves fresh meat and fish longer.
	Inverter technology: The evolution of Smeg's driers towards more intelligent and environmentally sustainable models has led to the choice of using Inverter technology with heat pumps, which reduces significantly energy consumption.		Air plus: keeps food fresher for longer.