

FC20UXDNE



Product family	Refrigerator
Installation	Free-standing
Category	Bottom mount
Reference width	Until 60
Cooling type	No-frost
Defrost	Automatic
Hinge	Standard
Slot-in	Yes
Kitchen panel	Not supplied
Hinge position	Right
Reversible door	Yes
EAN code	8017709312992



Aesthetic



Aesthetics	Universal	Side color	Silver
Color	Stainless steel	Logo	Applied
Finishing	Fingerprint-proof	Door shelf profile color	White
Material	Stainless steel effect	Glass shelf profile color	Silver
Door stainless steel type	Fingerprint-proof	Display	LED
Handle	External	Display position	On door
Side material	Steel		

Refrigerator compartment features



No. of adjustable shelves	3	Bottle shelf	Yes
Number of fruit and vegetables drawers	1	Low temperature compartment	Yes
Type of adjustable shelves	Glass	Refrigerator lighting	LED
Crisper drawer type	Sliding crisper		

Refrigerator Inner Door

Number of adjustable door shelves	3	No. of bottle shelves	1
-----------------------------------	---	-----------------------	---

Other Refrigerator features



Accessories

Egg tray

MultiFlow

Yes

Freezer features

Number of drawers 3

Other technical features



Display functions

Fast-freezing, ECO

Temperature alarm

Yes

Door open alarm

Yes

Temperature setting type

Electronic

No. of compressors

1

Refrigerant gas type

R600a

Compressor type

Standard

Refrigerant quantity

1.1 oz

Foam agent

Cyclopentane

Performance / Energy Label NEW

Noise level 38 dB(A) re 1 pW

Electrical Connection

Plug (A) USA & Mexico

Frequency (Hz) 60 Hz







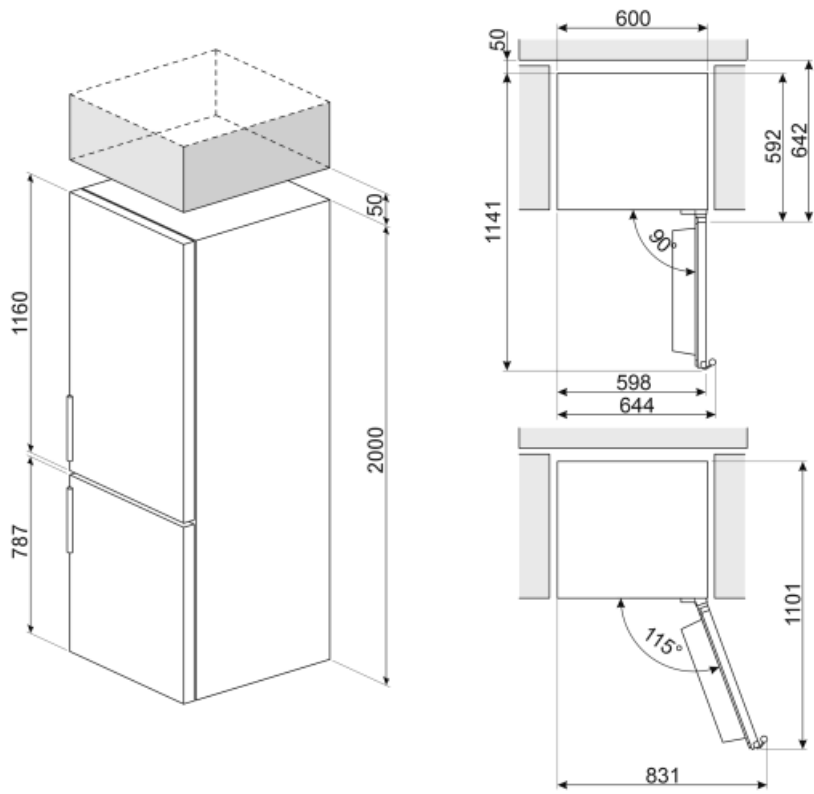

Current 10 A

Power cord length 74 13/16 "

Voltage (V) 120 V



Symbols glossary (TT)

	The automatic defrost system works by automatically defrosting at regular intervals eliminating the need to defrost altogether.		LED display: to show programmes, functions and options selected and the time to the end of the cycle.
	Economical mode: Analyzes fridge functioning during the activation and optimizes the operating cycle in order to reduce power consumption.		Fast freezing: The fast freezing function brings the temperature of the compartment down when activated a few hours prior to usage.
	Fingerprint proof stainless steel: Fingerprint proof stainless steel keeps stainless steel looking as good as new.		LED interior lighting: is a more energy efficient and long lasting way of illuminating the interior of the appliance.
	Air plus: keeps food fresher for longer.		Slot-in: The refrigerators with Slot-in opening can be perfectly integrated into the furniture structure, as the doors open at 90° do not go beyond the side of the product. In case of installation next to the wall, it will be necessary to consider the dimensions of the handle in order to open the door at 90°.