

FK30BI-RS1

30", FRIDGE AND FREEZER, OT Model

BUILT-IN

CLASSIC® SERIES

Fhiaba



FEATURES

- Made in Italy
- TriMode™: Total Flexibility, make the bottom drawer a refrigerator, fresh food space, or freezer with the control menu
- OptiView™: OptiView LED lights
- EventLift™: Easily rearrange the shelving without removal using the EvenLift system
- ProVent™: Uniform air circulation maintains consistent temperatures throughout the appliance resulting in better food preservation
- Antibacterial Stainless Steel Interiors Drawers: Achieve the highest food quality by storing food in the stainless steel interior drawer that shields against the spread of bacteria
- Total No Frost: No more frost build-up that requires defrosting
- Ice Maker: Get high-quality ice cubes in a variety of sizes
- Water Filter: Get pure water and crystal-clear ice thanks to the integrated water filter and ice maker
- SuperIce™: Temporarily increase ice cube production for gatherings and parties
- Ice Size: Easily switch between medium and large ice cubes
- EquiLance™: Achieve a seamless built-in look with Fhiaba's innovative door hinge
- Soft - Close System: State-of-the-art closing system ensures refrigerator crisper drawers close smoothly and quietly

GENERAL PROPERTIES

Equilance Hinge	YES
Soft-Closing Glides	YES
Low Vibration	YES
OptiView (Led Light Spots)	YES
Shelves	2
Type Of Shelves	GLASS
Door Bins	3
Fridge Interior Drawers	2
Freezer Drawers	1+1 internal
Evenlift Shelves	YES
Full Extension Shelves 90° Door Opening	NO
Full Extension Drawers 90° Door Opening	YES
Defrost Process	AUTOMATIC
Door Open Alarms	YES
Shopping Fridge	YES
Shopping Freezer	YES
Power Failure Alert	YES
Ice Maker With Water Filter	YES
Water Dispenser With Water Filter	NO
Water Filter Cartridge	YES

FK30BI-RS1

30", FRIDGE AND FREEZER, OT Model

BUILT-IN

CLASSIC® SERIES

PRODUCT DETAIL

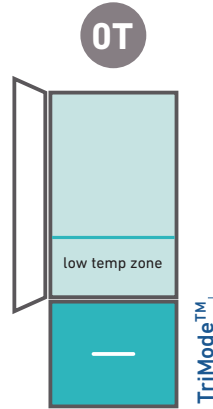
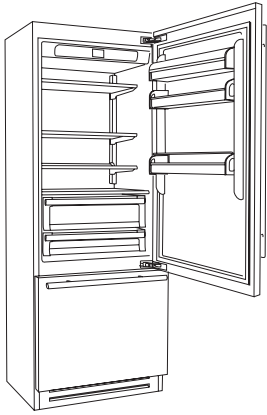

1D | 1BD | 2M

D = door
BD = drawer
M = separate microclimates

CAPACITY

Net Capacity	15.5 cuft (440 l)
Upper Compartment Wine Cellar Capacity (Bottles)	N/A
Lower Compartment Wine Cellar Capacity (Bottles)	N/A

TECHNICAL DETAILS

Total Absorbed Current (A)	3.5
Voltage (V)	115
Frequency (Hz)	60
Power Cord Length	78 3/4" (2 m)
Plug Type	Nema 5-15P
Climate Class	SN/T
Refrigerant (Gas)	R600a
Water Connection / Female Attachment	3/4" NPT (1/4" elbow adapter)

EFFICIENCY

Estimated Yearly Electricity Use	502 kwh
----------------------------------	---------

DIMENSIONS & WEIGHT

Height Of The Product (Minimum)	83 1/2" (2120 mm)
Adjustable Feet Height	up to 1" (25 mm)
Width Of The Product	29 7/8" (760 mm)
Depth Of Product Without Handle	24 3/8" (620 mm)
Cut-out Height	84" (2134 mm)
Cut-out Width	30" (762 mm)
Cut-out Depth	min 24 3/4" (630 mm)
Net Weight	406 lbs (184 kg)
Gross Weight	452 lbs (205 kg)

TEMPERATURE RANGES

Climate Zones	2
Compartment 1 / Upper Temperature	from 34°F(1°C) to 45°F (7°C)
Compartment 2 / Middle Temperature	N/A
Compartment 3 / Low Temperature	from 9°F (-13°C) to -9°F (-23°C)

FK30BI-RS1

30", FRIDGE AND FREEZER, OT Model

BUILT-IN

CLASSIC® SERIES

PRODUCT SPECIFICATIONS AND DIMENSIONS

Fhiaba

FRONT VIEW

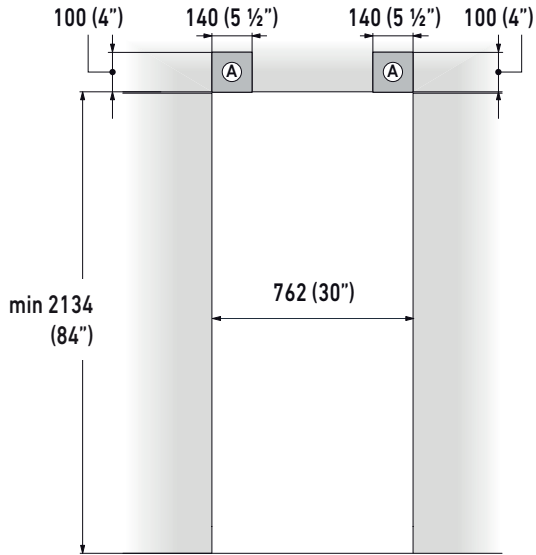

A

Area to be left clear for the anti-tipping brackets

SIDE VIEW

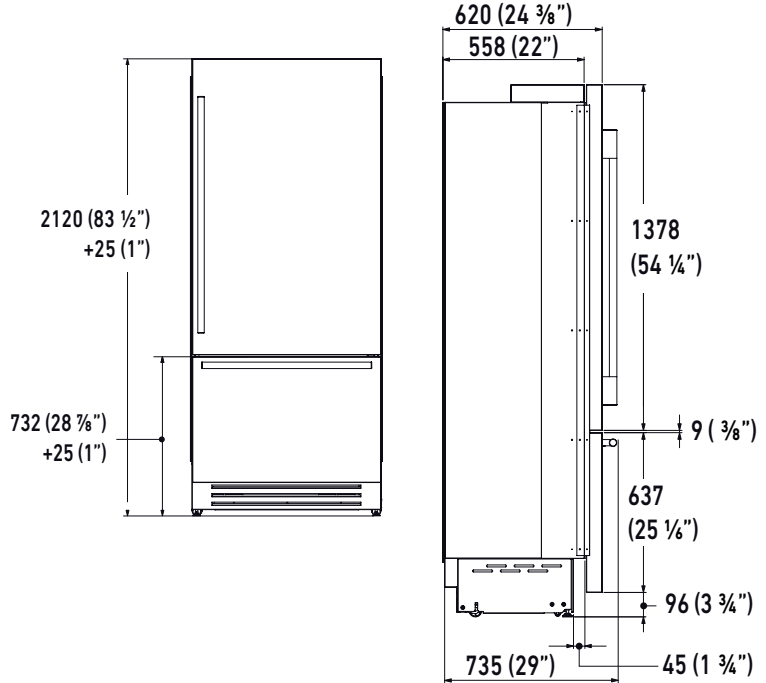

PLINTH SIZE

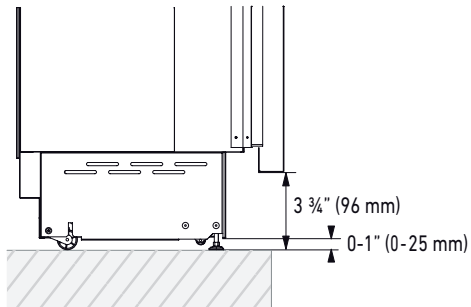

FK30BI-RS1

30", FRIDGE AND FREEZER, OT Model

BUILT-IN

CLASSIC® SERIES

PRODUCT SPECIFICATIONS AND DIMENSIONS

TOP VIEWS



Door swing clearance

Minimum distance from the wall (hinge side)

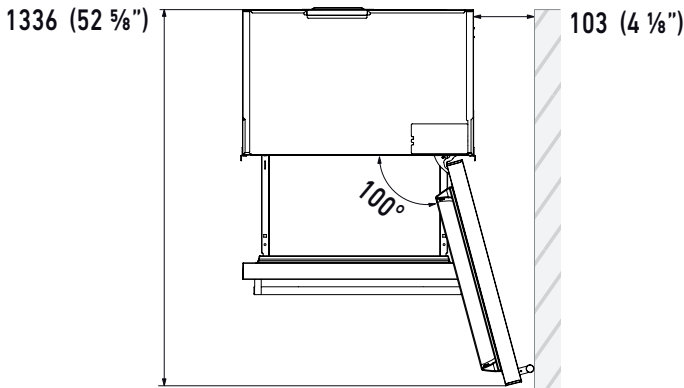

Width of the body of the appliance

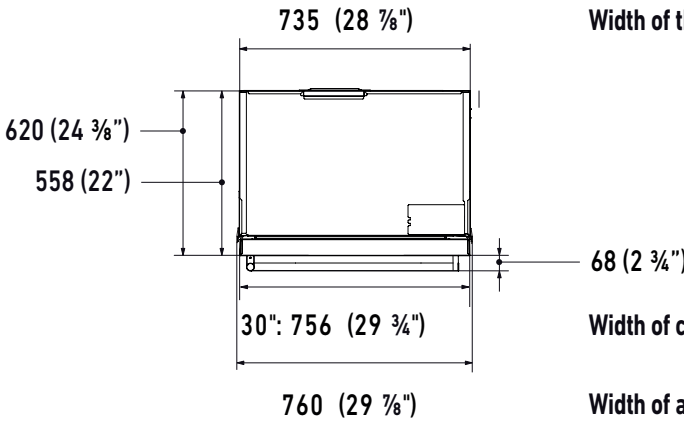

Width of cladded door

Width of appliance with mounting brackets installed (effective width)

Electrical Connection

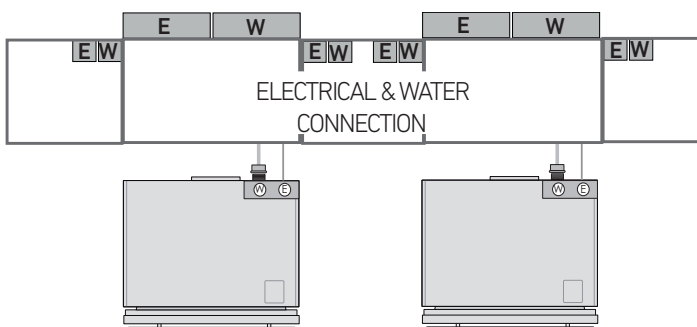

Electrical and water connections (if applicable) should be reachable without having to uninstall the appliance. If the connections must be made directly behind the appliance then it is recommended to recess those connections. **IMPORTANT:** do not put the water shut-off valve behind the appliance where it will be inaccessible.