

FQ55UFX



Product family	Refrigerator
Installation	Free-standing
Category	2 doors & 2 drawers
No-frost system	Total
Cooling type	Fan-assisted refrigerator, no-frost freezer
Defrost	Automatic
Hinge	Standard
EAN code	8017709303891



Aesthetic



Aesthetics	Universal	Handle	Integrated
Color	Stainless steel	Side material	Steel
Finishing	Fingerprint-proof	Logo	Applied
Design	Flat	Display	LED
Material	Stainless steel effect	Display position	Internal
Door stainless steel type	Fingerprint-proof		

Refrigerator compartment features



No. of adjustable shelves	2	Type of crisper cover	Glass
Number of fruit and vegetables drawers	3	Refrigerator lighting	Yes
Type of adjustable shelves	Glass	Refrigerator lighting	LED
Crisper cover	Yes		

Refrigerator Inner Door

Number of adjustable door shelves	4	No. of bottle shelves	2
-----------------------------------	---	-----------------------	---

Other Refrigerator features

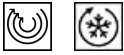

MultiFlow

Yes

Fan

Yes

Freezer features

Number of drawers 2

Other Freezer features

Ice maker Automatic

Ice-tray shelf

Yes

Other technical features



Display functions

Fast-freezing, Fast-cooling, Child lock

MultiZone

Yes

Fast-freezing button

Yes

Water network connection

Yes

Temperature setting type

Electronic

Refrigerant gas type

R600a

Compressor type

Inverter

Foam agent

Cyclopentane

Performance / Energy Label NEW

Noise level 45 dB(A) re 1 pW

Electrical Connection

Plug (A) USA & Mexico

Voltage (V)

115 V

Electrical connection rating 140 W

Frequency (Hz)

60 Hz







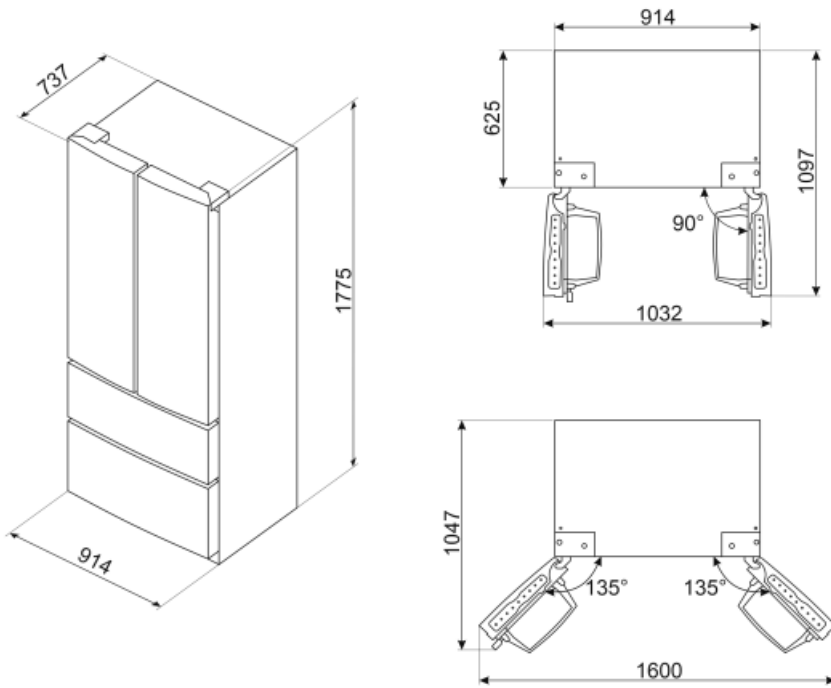



Current 2.5 A

Power cord length

66 15/16 "



Symbols glossary (TT)

	The automatic defrost system works by automatically defrosting at regular intervals eliminating the need to defrost altogether.		Child lock: some models are fitted with a device to lock the programme/cycle so it cannot be accidentally changed.
	LED display: to show programmes, functions and options selected and the time to the end of the cycle.		Ventilated: Forced distribution of cold air in the refrigerator compartment, which allows even temperature distribution within the fridge.
	Fast freezing: The fast freezing function brings the temperature of the compartment down when activated a few hours prior to usage.		Fingerprint proof stainless steel: Fingerprint proof stainless steel keeps stainless steel looking as good as new.
	LED interior lighting: is a more energy efficient and long lasting way of illuminating the interior of the appliance.		Inverter technology: The evolution of Smeg's driers towards more intelligent and environmentally sustainable models has led to the choice of using Inverter technology with heat pumps, which reduces significantly energy consumption.
	Air plus: keeps food fresher for longer.		No Frost: The No Frost and Frost free systems prevent ice from forming so that no defrosting is required.