

Installation Guide and User manual

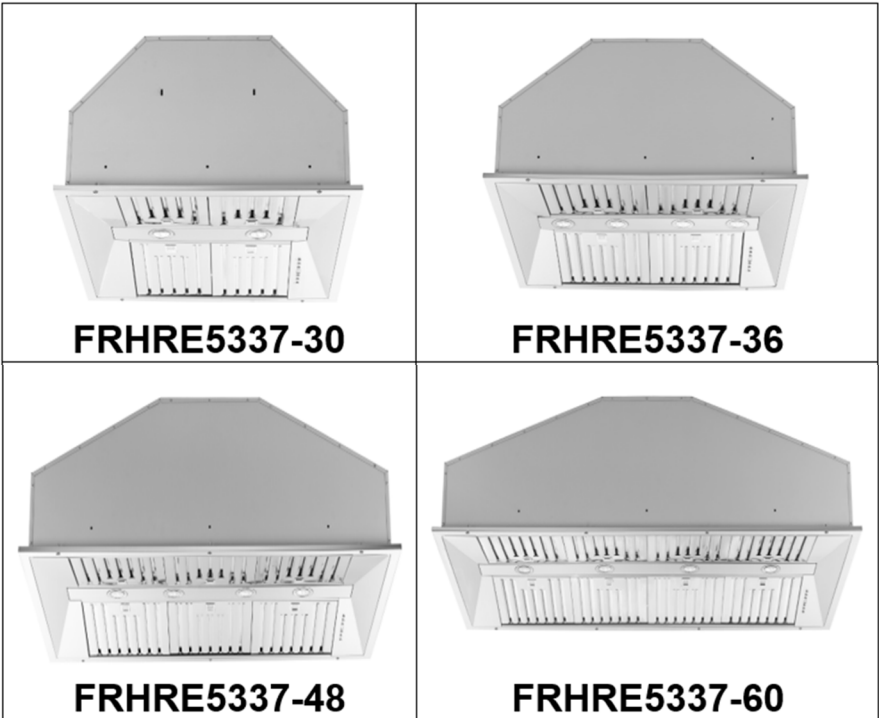

IMPORTANT:

Read and save these instructions

NOTICE:

Installer: Leave this guide with the homeowner

Homeowner: Keep this guide for future reference

BUILT IN RANGE HOOD

Customer Care

Thank you for purchasing a **FORNO** product. Please read the entire instruction manual before operating your new appliance for the first time. Whether you are an occasional user or an expert, it will be beneficial to familiarize yourself with the safety practices, features, operation and care recommendations of your appliance.

Both the model and serial number are listed inside the product. For warranty purposes, you will also need the serial number, the date of purchase & a copy of your proof of purchase. Record this information below for future reference.

SERVICE INFORMATION

Use these number in any correspondence or service calls concerning your product.

Model Number

If you received a damaged product, immediately contact **FORNO**.

Serial Number

Save time and money. Before you call for service, check the Troubleshooting Guide. It lists the causes of minor operating problems that you can correct yourself.

Date of Purchase

Purchase Address & Phone

SERVICE IN CANADA & UNITED STATES

Keep the instruction manual handy to answer your questions. You can also find all the information you need online at www.forno.ca.

If you don't understand something or need more assistance, please visit our website or email: mysupport@forno.ca

If there is a problem, please contact FORNO customer service. Please note that troubleshooting with a customer service representative will be needed before being able to send a service provider. All warranty work needs to be authorized by FORNO customer service. All our authorized service providers are carefully selected and rigorously trained by us.

Warranty

What this limited warranty covers:

The Warranty coverage provided by Forno Appliances in this statement applies exclusively to the original Forno appliance ("Product") sold to the consumer ("Purchaser") by an authorized Forno dealer/distributor/retailer, purchased and installed in the United States or Canada, and which has always remained within the original country of purchase (the United States or Canada). Warranty coverage is activated on the date of the Product's original retail purchase and has a duration of two (2) years.

Warranty coverage is non-transferable. In the event of replacement of parts or of the entire product, the replacement Product (or parts) shall assume the remaining original Warranty activated with the original retail purchase document. This Warranty shall not be extended with respect to such replacement. Forno Appliances will repair or replace any component/part which fails or proves defective due to materials and/or workmanship within 2 years of the date of the original retail purchase and under conditions of ordinary residential, non-commercial use. Repair or replacement will be free of charge, including labor at standard rates and shipping expenses. Purchaser is responsible for making the Product reasonably accessible for service. Repair service must be performed by a Forno Authorized Service company during normal working hours.

IMPORTANT

Retain proof of original purchase to establish warranty period. Forno's liability on any claim of any kind, with respect to the goods and/or services provided, shall in no event exceed the value of the goods or service or part there of which has given rise to the claim.

30-Day Cosmetic Warranty

The Purchaser must inspect the product at the time of delivery. Forno warrants that the Product is free from manufacturing defects in materials and workmanship for a period of thirty (30) days from date of the original retail purchase of the Product.

This coverage includes:

- Paint blemishes
- Chips
- Macroscopic finish defects

Cosmetic warranty does NOT cover:

- > issues resulting from incorrect transport, handling and/or installation (e.g.: dents, broken, warped or deformed structures or components, cracked or otherwise damaged glass components);
- > slight color variations on painted/enamelled components;
- > differences caused by natural or artificial lighting, location or other analogous factors;
- > stains/corrosion/discoloration caused by external substances and/or environmental factors;
- > labor costs, display, floor, B-stock, out- of-box, "as is" appliances and demo units.

How to receive service

To receive warranty services, the Purchaser must contact the Forno Support department in order to determine the problem and the required service procedures. Troubleshooting with a customer service representative will be necessary before moving forward with the service. Model number, serial number and date of original retail purchase will be requested.

Warranty Exclusions: What Is Not Covered.

- > Use of the Product in any non-residential, commercial application.
- > Use of the Product for anything other than its intended purpose.
- > Repair services provided by anyone other than a Forno Authorized Service agency.
- > Damages or repair services to correct services provided by unauthorized parties or the use of unauthorized parts.
- > Installation not in accordance with local/state/city/county fire codes, electrical codes, gas codes, plumbing codes, building codes, laws or regulations.
- > Defects or damage due to improper storage of the Product.
- > Defects, damage or missing parts on products sold out of the original factory packaging or from displays.
- > Service calls or repairs to correct an incorrect installation of the Product and/or related accessories.
- > Replacement of parts/service calls to connect, convert or otherwise repair the electrical wiring and/or gas line in order to properly use the product.
- > Replacement of parts/service calls to provide instructions and information on the use of the Product.
- > Replacement of parts/service calls to correct issues arising from the product being used in a manner other than what is normal and customary for residential use.
- > Replacement of parts/service calls due to wear and tear of components such as seals, knobs, pan supports, shelving, cutlery baskets, buttons, touch displays, scratched or broken ceramic-glass tops.
- > Replacement of parts/service calls for lack of/improper maintenance, including but not limited to: build up of residues, stains, scratches, discoloration, corrosion.
- > Defects and damages arising from accidents, alteration, misuse, abuse or improper installation.
- > Defects and damages arising from Product transport, logistics and handling. Inspection of the product must be made at time of delivery. Following receipt and inspection, the selling dealer/delivery company must be notified of any issues arising from handling, transport and logistics.
- > Defects and damages arising from external forces beyond the control of Forno Appliances, including but not limited to wind, rain, sand, fires, floods, mudslides, freezing temperatures, excessive moisture or extended exposure to humidity, power surges, lightning, structural failures surrounding the appliance and other acts of God.
- > Products whose serial number has been altered/damaged/tampered with. In no case shall Forno be held liable or responsible for damage to surrounding property, including furniture, cabinetry, flooring, panels, and other structures surrounding the Product. Forno is neither liable nor responsible for the Product if it is located in a remote area or an area where certified trained technicians are not reasonably available. Purchaser must bear any transportation and delivery costs of the Product to the nearest Authorized Service Center or the additional travel expenses of a certified trained technician

THERE ARE NO EXPRESS WARRANTIES OTHER THAN THOSE LISTED AND DESCRIBED ABOVE, AND NO WARRANTIES, EITHER EXPRESS OR IMPLIED, INCLUDING, BUT NOT LIMITED TO, ANY IMPLIED WARRANTIES OF MERCHANTABILITY OR FITNESS FOR A PARTICULAR PURPOSE THAT SHALL APPLY AFTER THE EXPRESS WARRANTY PERIODS STATED ABOVE, AND NO OTHER EXPRESS WARRANTY OR GUARANTEE GIVEN BY ANY PERSON, FIRM OR CORPORATION WITH RESPECT TO THIS PRODUCT SHALL BE BINDING ON FORNO. FORNO SHALL NOT BE LIABLE FOR LOSS OF REVENUE OR PROFITS, FAILURE TO REALIZE SAVINGS OR OTHER BENEFITS, TIME AWAY FROM WORK, MEALS, LOSS OF FOOD OR BEVERAGES, TRAVELING OR HOTEL EXPENSES, EXPENSES TO RENT OR PURCHASE APPLIANCES, REMODELING/CONSTRUCTION EXPENSES IN EXCESS OF DIRECT DAMAGES WHICH ARE UNDENIABLY CAUSED EXCLUSIVELY BY FORNO OR ANY OTHER SPECIAL, INCIDENTAL OR CONSEQUENTIAL DAMAGES CAUSED BY THE USE, MISUSE OR INABILITY TO USE THIS PRODUCT, REGARDLESS OF THE LEGAL THEORY ON WHICH THE CLAIM IS BASED, AND EVEN IF FORNO HAS BEEN ADVISED OF THE POSSIBILITY OF SUCH DAMAGES. NOR SHALL RECOVERY OF ANY KIND AGAINST FORNO BE GREATER IN AMOUNT THAN THE PURCHASE PRICE OF THE PRODUCT SOLD BY FORNO AND CAUSING THE ALLEGED DAMAGE. WITHOUT PREJUDICE TO THE FOREGOING, PURCHASER ASSUMES ALL RISK AND LIABILITY FOR LOSS, DAMAGE OR INJURY TO PURCHASER AND PURCHASER'S PROPERTY AND TO OTHERS AND THEIR PROPERTY ARISING FROM THE USE, MISUSE, OR INABILITY TO USE THIS PRODUCT SOLD BY FORNO THAT IS NOT A DIRECT RESULT OF NEGLIGENCE ON THE PART OF FORNO THIS LIMITED WARRANTY SHALL NOT EXTEND TO ANYONE OTHER THAN THE ORIGINAL PURCHASER OF THIS PRODUCT, IS NON-TRANSFERABLE, AND STATES YOUR EXCLUSIVE REMEDY.

SAFETY INSTRUCTIONS



This is the safety alert symbols. These symbols alert you to potential hazards that can hurt

you and others. All safety messages will follow the safety alert symbols.

READ ALL INSTRUCTIONS BEFORE INSTALLING AND OPERATING THIS APPLIANCE.

- The installation instructions in this manual are intended for qualified installers, service technicians, or persons with similar qualified background. Installation and electrical wiring must be done by qualified professionals and in accordance with all applicable codes and standards, including first-rated construction. DO NOT attempt to install this appliance yourself. Injury could result from installing the unit due to lack of appropriate electrical and technical background. Due to the size and weight of this range hood, two people installation is recommended.
- Range hood may have very sharp edges; please wear protective gloves if it is necessary to remove any parts for installing, cleaning, or servicing.
- Activating any switch ON before completing installation may cause ignition or an explosion.

TO REDUCE THE RISK OF FIRE, ELECTRIC SHOCK OR INJURE TO PERSONS, PLEASE OBSERVE THE FOLLOWINGS:

- Your safety and the safety of others is very important. We have provided many important safety messages in this manual and on your appliance. Always read and obey all safety messages. All safety messages will tell you what the potential hazard is, tell you how to reduce the chance of injury, and tell you what can happen if the instructions are not followed.
- All electrical wiring must be properly installed, insulated, and grounded.
- Old duct work should be cleaned or replaced, if necessary, to avoid the possibility of a grease fire. Check all joints on duct work to insure proper connection, all joints should be properly taped.
- When the range hood ventilates the air out of the room, the air vented must be replaced, this is called make-up air. If a makeup air system is needed, but not used, a hood may not function as expected due to negative air pressure. We do not currently provide a make-up air unit. Always consult any applicable building codes in your area regarding minimum and maximum air flow rates. Certain states may require additional items such as make-up air for larger CFM range hoods (typically over 300 CFM).
- To reduce the risk of fire and to disperse air properly, make sure to vent air outside. DO NOT vent exhaust into spaces between walls, crawl spaces, ceilings, attics, or garages.
- For residential ventilating use only. DO NOT use to exhaust hazardous or explosive materials and vapors. The combustion air flow needed for safe operation of fuel-burning equipment may be affected by this unit's operation. Follow the heating equipment manufacturer's guideline and safety standards such as those published by the National Fire Protection Association (NFPA), and the American Society of Heating, Refrigeration and Air Conditioning Engineers (ASHRAE), and the local code authorities. Sufficient air is

needed for proper combustion and exhausting of gases through the duct to prevent back drafting.

- Ducted range hoods MUST ALWAYS be vented to the outdoors. All our range hoods come with a transition piece with a built-in damper. Some existing installations may already have an external damper. Please consult an HVAC or installation professional for advice to comply with local regulations.
- Keep all fans, baffle, spaces, filter, grease tunnel, oil container and grease-laden surfaces clean. Grease should not be allowed to accumulate on fan, baffle, spaces, filter, grease tunnel or oil container. Clean grease-laden surfaces frequently.
- This appliance is design to be operated by adults. Children were not allowed to temper with the controls or play with this appliance.
- To reduce the risk of fire or electric shock, do not use this fan with any solid-state speed control device.
- When cutting or drilling into wall or ceiling, do not damage electrical wiring and other hidden utilities.
- Before servicing or cleaning unit, switch power OFF at service panel and lock service panel to prevent power from being switched ON accidentally.
- Use this unit only in the manner intended by the manufacturer. If you have any questions, contact the FORNO.

TO REDUCE THE RISK OF INJURY TO PERSONS IN THE EVENT OF A STOVE TOP GREASE FIRE:

- All FORNO range hoods are ETL listed, ensuring all parts were tested for safety and meet industry standards and regulations. NOTE: This ensures all included metal ducting pieces were tested for safety and are flame retardant.
- Always turn hood ON when cooking at high heat or when cooking flaming foods (Crepes Suzette, Cherries Jubilee, Peppercorn Beef Flambe). Never leave surface units unattended at high settings. Boil overs cause smoking and greasy spillovers that may ignite. Heat oils slowly on low or medium settings.
- Clean hood frequently. Grease should not be allowed to accumulate on fan or filter.
- Use proper pan size. Always use cookware appropriate for the size of the surface element.

INSTALLATION & USE

NOTE 1: On stainless steel hoods, carefully remove the plastic protective film (if have) from all exterior surfaces of the hood and chimney prior to final installation

NOTE 2: At least two people will be required to mount the hood.

DESCRIPTION / CONNECTION

This range hood should be mounted directly to the support frame mounting, where the support frame flue shall secure to the ceiling joist or framework.

- Ductwork can be installed vertically or horizontally.
- Duct runs should be as short as possible.
- Avoid the use of elbows.
- Use duct tape at all joints.
- Do not use duct smaller than the discharge on the hood.

Electrical Connection

- Electrical wiring must be done by a qualified person(s) in accordance with all applicable codes and standards.
Turn off electrical power at service entrance before wiring.
- If the supply cord is damaged, it must be replaced by the manufacturer, its service agent, or similarly qualified persons to avoid a hazard.
- Do not use the plug and an extension cord other than the ones initially supplied with the hood.













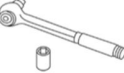



The earthing of this hood is compulsory. Do not remove ground prong of the plug.

* The earthing of this hood is compulsory. Do not remove ground prong of the plug.

INSTALLATION PREPARATION

* Please plug in and check that all functions are working

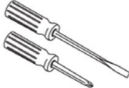
TOOLS AND MATERIALS REQUIRED (Not supplied)

	Pencil and tape measure		Duct tape
	Wire cutter/stripper		Wrench
	Hammer		Keyhole Saw
	Level		Safety glasses
	Step ladder		Electric or battery-operated drill and 1/8", 3/8" bits
	Wire nuts		10" round metal duct, length to suit installation
	Pliers		Metal Snips
	Saber saw or Sawzall		Flashlight
	Screwdrivers		Strain relief for joint cover.
	120V 60Hz. 15 or 20 Amp, 2-wire with ground. Properly grounded branch circuit.		

MOUNT HEIGHTS & CLEARANCE

The minimum mounting height between range top to hood bottom should be no less than 30".

The optimal maximum height should be 36" above the cooktop (please note that the 36", 48" & 60" unit can install up to 42" above the cooktop, but it may result in a loss of efficiency).

It is important to install the hood at the proper mounting height. Hoods mounted too low could result in heat damage and fire hazard; while hoods mounted too high will be hard to reach and will lose its performance and efficiency.

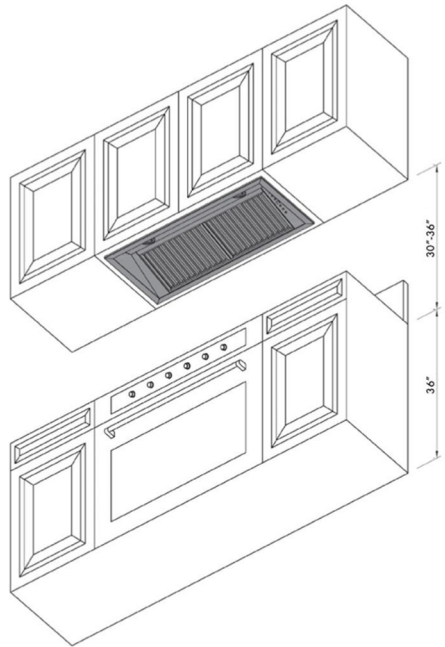

Ducting (not provided)

NEVER exhaust air or terminate duct work into spaces between walls, crawl spaces, ceiling, attics or garages.

All exhaust must be ducted to the outside. Use Metal ductwork only.

Fasten all connections with sheet metal screws and tape all joints w/ certified Silver Tape or Duct Tape.

Duct Run Calculation:

Maximum run 6" or 3-1/4 x 10" duct	100FT
Deduct:	
each 90 Elbow used	15FT
each 45 Elbow used	9FT
each 6" to 3-1/4 x 10"	1FT
transition used	
each 3-1/4 x 10" to 6"	5FT
transition used	
Side Wall Cap w/ damper	30FT
Roof Cap	30FT

DUCT SIZE

A minimum of ϕ 6" for 30" & 10" for 36", 48" and 60" round duct must be used to maintain maximum airflow efficiency.

Flexible ducts are provided for convenience, always use rigid type metal ducts to maximize airflow.

Also use calculation (on left) to compute total available duct run when using elbows, transitions, and caps.

ALWAYS reduce the number or transitions and turns. If required a long duct increase duct size from 6" to 8" for the 30" & from 10" to 12" for the 36", 48" and 60".

If a reducer is used, install a long reducer instead of pancake reducer. Reduce duct size as far away from opening as possible.

If turns or transitions are required: Install as far away from opening and as far apart, between 2, as possible.

e.g. – 1 roof cap, 2x90 elbows, 1x45 elbow =
 30' + 30' + 9'=69' used, 31' available for
 straight duct runs

Prepare Location

Please unpack your range hood when it is delivered and inspect to ensure all parts are included.

- 1.Hood body with Lights and Button Pre-Installed
- 2.Air Outlet Adapter ($\phi 6''$ for 30'', $\phi 10''$ for 36'',48'' and 60'')
- 3.Duct (1.5m long, $\phi 6''$ for 30'', $\phi 10''$ for 36'',48'' and 60'')
- 4.Baffle filters (4x for 30'',36''.6x for 48'',8x for 60'')
- 5.Screws and Anchors
- 6.Grease Cup
- 7.Instruction Manual

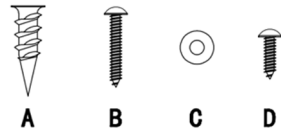
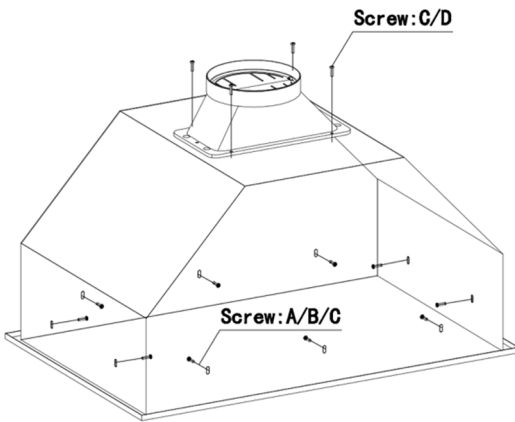

FRHRE5337-30

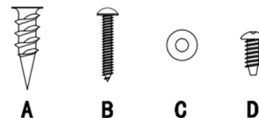
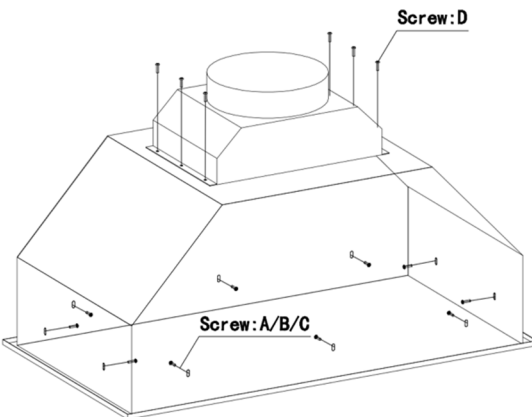

FRHRE5337-36, FRHRE5337-48, FRHRE5337-60

- Lay out the vent duct system before installing the range hood to determine the best routing for the vent duct.
- It is recommended that the vent system be installed before the range hood is installed.
- Range hood is to be installed 30" min. from cooking surfaces.
- At least two people will be required to mount the hood.
- Range hood is very heavy, must be installed in support structures. (Support structure is not included with range hood, please prepare yourself)

NOTE: Mounting holes location should be into support structure capable of holding 88bs (40kg)

Range Hood Installation

1. Measure and cut the opening at the bottom of the cabinet According to the dimensions indicated as below.

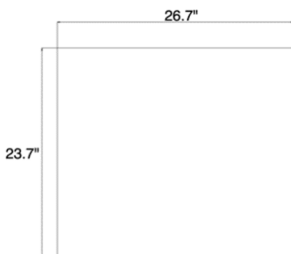

FRHRE5337-30: 26.7"X23.7"

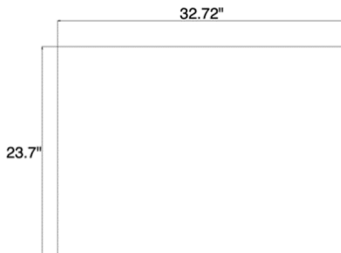

FRHRE5337-36: 32.72"X23.7"



FRHRE5337-48: 44.73"X23.7"

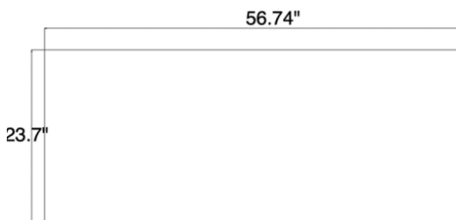

FRHRE5337-60: 56.74"X23.7"

2. Fix air outlet adapter over the hood by screws (ϕ 6" for 30", ϕ 10" for 36", 48" and 60").
3. Secure the duct connected with the air outlet adapter by using duct tape to seal the joints.

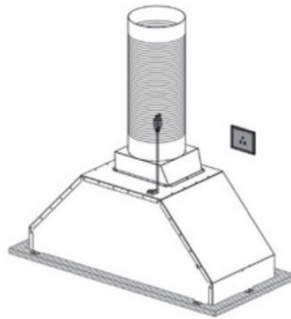
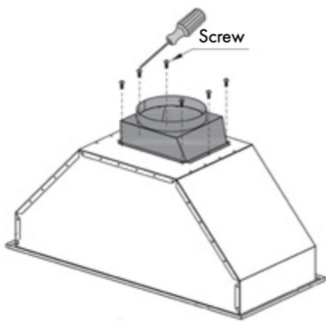

4. Loosen screws between range hood body and face plate. (4 screws in 30" and 36", 6 screws in 48", 8 screws in 60")
5. Lift the range hood body and insert it into the cabinet, secure the range hood to the support structures (3 screws in front and back, 2 screws in left and right), adjust the level of the range hood, then tighten all screws.

NOTE: Range hood is very heavy, please make sure support structures must be able to support the weight of hood in 88lbs(40kg)

Mounting holes in range hood locate in 2.35" high from range hood bottom, please install support structures in correct position.

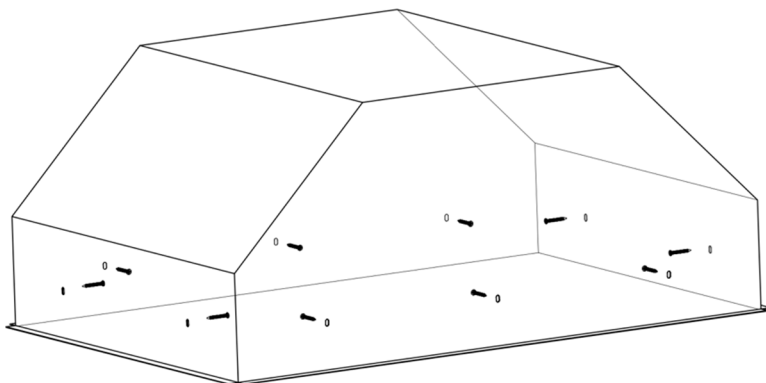

6. Fix face plate to range hood body by screws (4 screws in 30" and 36", 6 screws in 48", 8 screws in 60").
Install baffle filter to range hood.

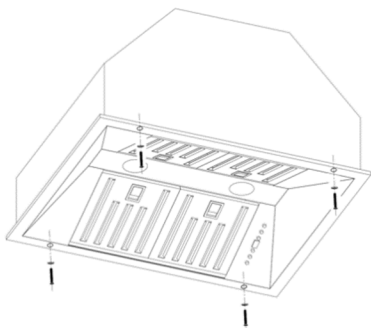

FRHRE5337-30: 4 screws.

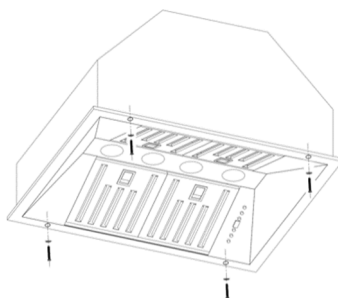

FRHRE5337-36: 4 screws

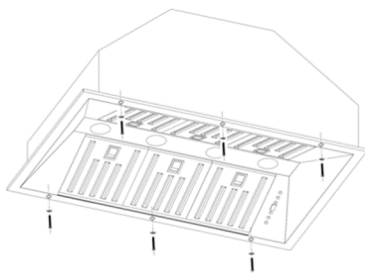

FRHRE5337-48: 6 screws

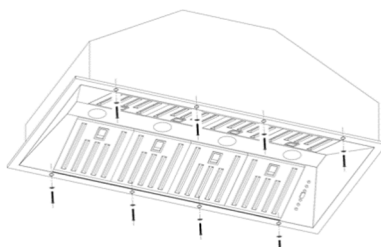

FRHRE5337-60: 8 screws

OPERATIONS

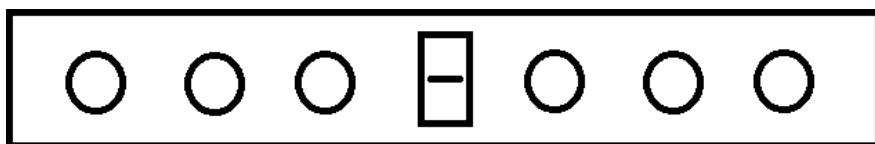

K1

K2

K3

LED

K4

K5

K6

K1: Power Button/Power-off Delay Button

When range hood is off, press this button to turn on range hood, press K2 K3 K4 K5 to adjust motor speed.

When range hood is on, press this button to enter Power-off delay function, timer is 3 minutes, the range hood will turn off automatically when time up.

K2: First Speed

K3: Second Speed

K4: Third Speed

K5: Fourth Speed

K6: Light Button. Turn on and off the light

MAINTENANCE & CLEANING

Surface Maintenance:

Clean periodically with hot soapy water and clean cotton cloth. Do not use corrosive or abrasive detergent (e.g. comet powder scrub, EZ-Off oven cleaner), or steel wool/scoring pads which will scratch and damage surface.

For heavier soil use liquid degreaser such as 'Formula 409' or 'Fantastic' brand cleaner.

After cleaning, you may use nonabrasive stainless-steel polish/cleaners such as 3M or ZEP, to polish and buff out the stainless luster and grain. Always scrub lightly, with clean cotton cloth, and with the grain

Filters:

The Filters fitted by the factory are intended to filter out residue and grease from cooking. It need not be replaced on a regular basis but are required to be kept clean.

Filters should be cleaned after every 30 hours of use.

Remove and clean by hand in a basin of hot soapy water. The filter is also dishwasher safe.

If heavily soiled, spray 'Formula 409' or equivalent degreasing detergent and leave to soak.

Dry filters and re-install before using hood.

Hood Cleaning

The saturation of greasy residue in the blower and filters may cause increased inflammability. Always keep unit clean and free of grease and residue build-up to prevent possible fires.

Filters must be cleaned periodically and free from accumulation of cooking residue (see cleaning instructions inside). Old and worn filters must be replaced immediately. Do not operate blowers when filters are removed. Never disassemble parts to clean without proper instructions. Disassembly is recommended to be performed by qualified personnel only. Call our service center for removal instructions.

Stainless steel is one of the easiest materials to keep clean. Occasional care will help preserve its fine appearance.

Cleaning tips:

- * Hot water with soap or detergent is all that is usually needed.
- * Rinse with clear water. Wipe dry with a clean, soft cloth to avoid water marks.
- * For discolorations or deposits that persist, use a non-scratching household cleanser or stainless-steel polishing powder with a little amount of water and a soft cloth.
- * For stubborn stain, use a plastic scouring pad or soft bristle brush together with cleanser and water. Rub lightly in direction of polishing lines or "grain" of the stainless finish. Avoid using too much pressure that may mar the surface.
- * Do not allow deposits to remain for long periods of time.
- * Do not use ordinary steel wool or steel brushes. Small bits of steel may adhere to the surface causing rust.
- * Do not allow salt solutions, disinfectants, bleaches, or cleaning compounds to remain in contact with stainless steel for extended periods. Many of these compounds contain chemicals that may be harmful. Rinse with water after exposure and wipe dry with a clean cloth.
- * Painted surfaces should be cleaned with warm water and mild detergent only.

LIGHT bulbs

WARNING: Please ensure lights have been switched off for some time and the power source has been disconnected before replacing any globes. Please be aware that the light will retain heat for a short period of time after being switched off.

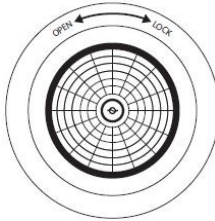

Step 1: Turn anti-clockwise to open

Step 2: Take the existing globe out

Step 3: Insert a new globe (GU10 Fitting) and turn clockwise in lock position

TROUBLESHOOTING

My hood is operating, but the air is moving slower than normal.

Check the filter for buildup and clean or replace it if needed. If the difficulty persists, check for obstructions in the ductwork. A common obstruction is buildup in the roof or wall cap, such as: bird nests or other debris.

What is make-up air?

When the range hood ventilates the air out of the room, the air vented must be replaced, this is called make-up air. We do not currently provide a make-up air unit. NOTE: Always consult any applicable building codes in your area regarding minimum and maximum air flow rates. Certain states may require additional items such as make-up air for larger CFM range hoods (typically over 300 CFM).

My range hood will not operate.

1. Check that there is power to the range hood. The most common issue is that the circuit breaker is off, or the fuse has blown.
2. Make sure the speed has been selected at the range hood controls.
3. Turn off power to the range hood and check that all the wires are properly connected.

My range hood is making a rattling noise.

This is probably attributed to one of the following:

1. The motor is loose – Turn off the power and remove the filter and check that all screws are secure and tight around the motor.
2. The duct work connection is loose – Turn off the power to the unit and check that the ductwork

connection to the pipe is tight. Add duct tape is necessary.

My range hood does not have power.

1. Check electrical connections.
2. Check that all connections to the circuit board are secure.
3. If the problem persists, please contact Forno Technical Support.

My range hood is not pulling.

- Was the unit plugged in and was the fan checked before installation?
- What distance is the hood mounted above the cook top?
- Is the range hood width the correct size for the cook top?
- Does the hood have enough BTU output in relationship to either their gas or electric stove cook top?
 - BTU output per burner/100 - for gas
 - Wattage output per burner/10 - for electric
- Are the baffle filters or mesh filters installed correctly? When were they last cleaned?
- Is the ducting clear?
- Is the damper opening properly once the hood is turned on?
- Is there air coming off the top of the hood?
- Is there air coming out of the upper chimney section?
- When tissue is placed on the baffle filters under the hood, does it hold the tissue?
- How many elbows and how long is the ducting run?
- Should be no more than 2-3 elbows, for every elbow subtract 15 feet. (See Duct Run Calculation Section).