

# FZU30LX



<b>Product family</b>	Freezers
<b>Installation</b>	Built-in
<b>Built-In Niche</b>	200
<b>Category</b>	One Door
<b>Reference width</b>	70 - 80
<b>Reference height</b>	Higher than 200
<b>Cooling type</b>	No-frost
<b>Hinge</b>	Door-to-door
<b>Hinge position</b>	Left



## Aesthetic

<b>Aesthetics</b>	Universal	<b>Handle color</b>	Stainless steel
<b>Color</b>	Stainless steel	<b>Side material</b>	Metal
<b>Material</b>	Stainless steel	<b>Side color</b>	Steel
<b>Door stainless steel type</b>	Normal	<b>Logo</b>	Applied
<b>Handle</b>	External	<b>Drawers profile color</b>	Silver
<b>Handle</b>	Fixed	<b>Display</b>	TFT

## Freezer features

<b>Freezer lighting</b>	Yes
<b>Freezer lighting</b>	Incandescent light
<b>Number of drawers</b>	4

## Other Freezer features

<b>Ice maker</b>	Automatico
------------------	------------

## Other technical features



<b>Display functions</b>	Holiday, Fast-freezing, MultiZone, Sabbath	<b>No. of compressors</b>	1
<b>Fast-freezing button</b>	Yes	<b>Refrigerant gas type</b>	R600a
<b>Power-on light</b>	Yes	<b>Type of compressor</b>	Inverter
		<b>Refrigerant quantity</b>	85 oz

Door-open alarm	Yes	Foam agent	Cyclopentane
Antibacterial Gasket	Yes	Metal panel on the back of the fridge	Metal
Type of temperature control	Electronic		

## Performance / Energy Label NEW

Total volume 119.4 gal

## Electrical Connection



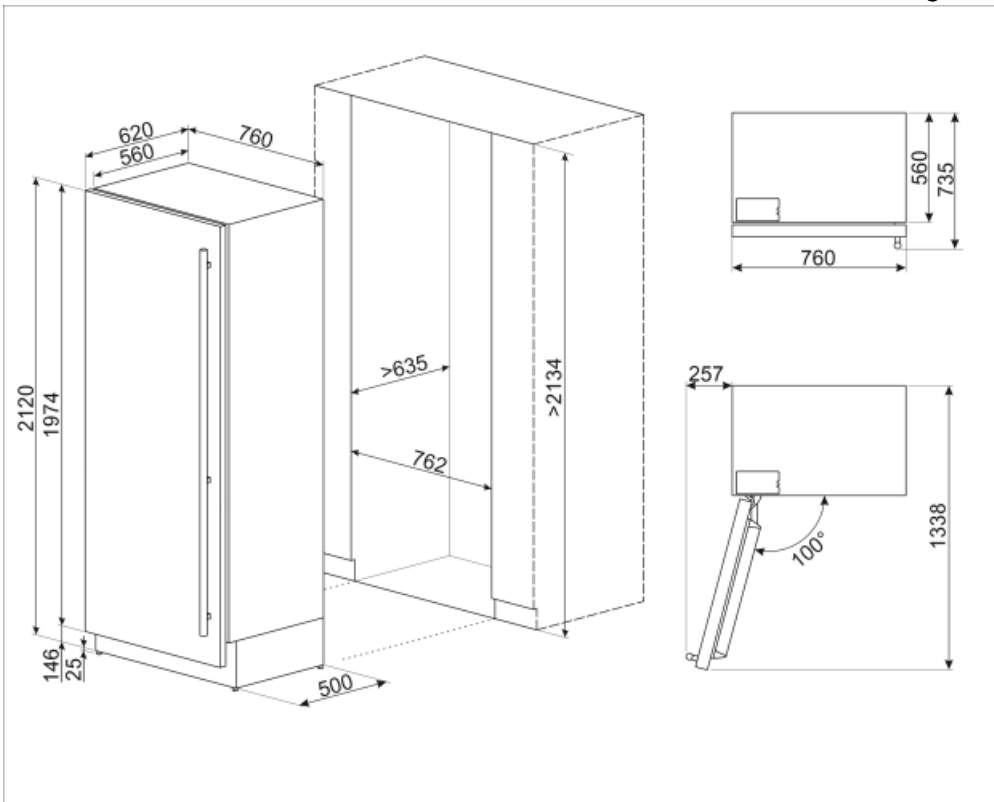



Plug	(A) USA & Mexico	Voltage	115 V
Nominal power rating	344 W	Frequency (Hz)	60 Hz
Current	15 A	Power cord length	78 3/4 "



---

## Symbols glossary (TT)

---

- |  |  |   |  |
|--|--|---|--|
|  | <b>Fast freezing:</b> The fast freezing function brings the temperature of the compartment down when activated a few hours prior to usage.   |  | <b>Power saving mode:</b> The power saving mode allows you to disable the refrigerator and keep the freezer working.   |
|  | <b>Inverter technology:</b> The evolution of Smeg's driers towards more intelligent and environmentally sustainable models has led to the choice of using Inverter technology with heat pumps, which reduces significantly energy consumption. |  | <b>Multizone:</b> Multizone compartment can be used as a refrigerator or a freezer compartment. Depending on your needs and eating habits, you can select settings, program the temperature using. |
|  | <b>Built-in niche</b>  |  | <b>No Frost:</b> The No Frost and Frost free systems prevent ice from forming so that no defrosting is required.   |