

Galanz

Model# GLR18FS5S16
REFRIGERATOR INSTRUCTION MANUAL

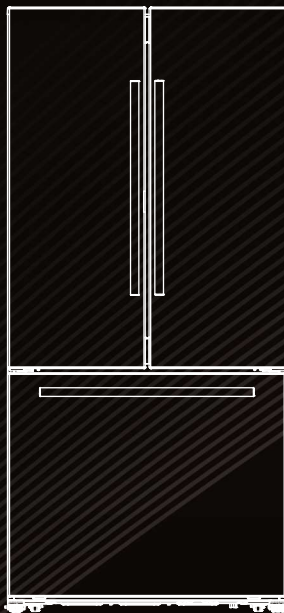

Thank you for purchasing a Galanz product. Please read this manual carefully for correct usage and safety, and keep for future reference. For service, support and warranty information, call 800-562-0738.

© 2021 Galanz Americas Limited Company.

CONTENT

Product overview	1
Safety warnings	2
Handling and placement.....	4
Instruction for usage.....	5
Maintenance and cleaning.....	7
Door handle installation.....	8
Guide for the installation	9
Connect water supply	10
Button instruction of display.....	12
The setting of the refrigerator compartment.....	12
The setting of the freezing room.....	12
The setting of the functions.....	13
Lighting and its replacement.....	14
Troubleshooting.....	15
Specifications and parameters.....	16
Packing list.....	17
Warranty.....	18

PRODUCT OVERVIEW

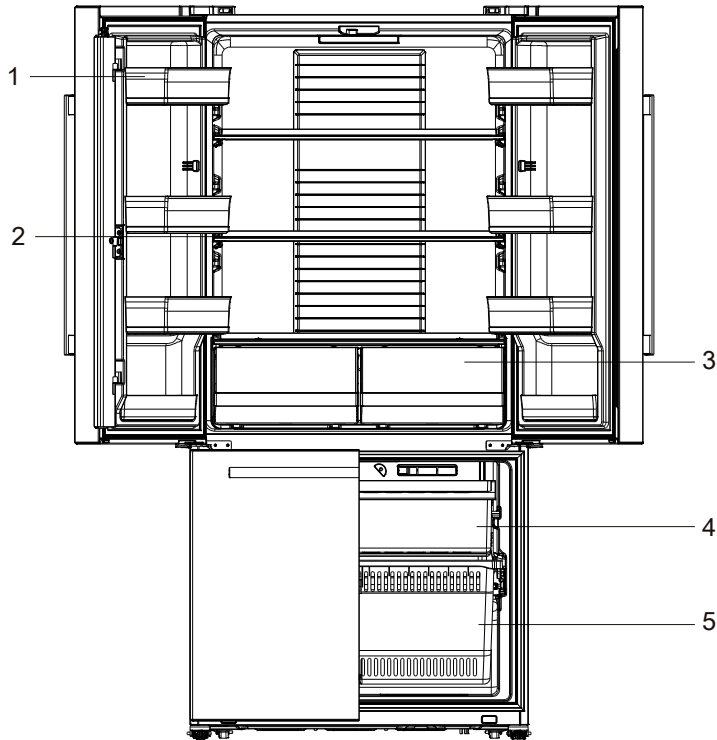

- 1. Door Bin
- 2. Glass shelf
- 3. Crisper
- 4. Freezer upper drawer
- 5. Freezer lower drawer

SAFETY WARNINGS

- ❖ The refrigerator you purchased uses a power supply voltage of 120V single-phase AC, with a frequency of 60HZ. It must be operated with a dedicated socket (above 10A) and reliably grounded. Do not remove the third pin (ground wire) of the power cord. The power cord plug should be firmly in contact with the socket, otherwise it may cause a fire.

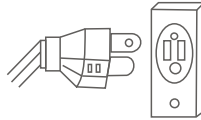

- ❖ It is recommended that electrical appliances such as power outlets, regulators, microwave ovens and unstable items (heavy objects, containers containing water) should not be placed on the top of the refrigerator. It is not allowed to use electrical appliances in the refrigerator except our recommended models.



- ❖ When your refrigerator is disused, please remove the door and door seal, to avoid an accident with children playing with the refrigerator.

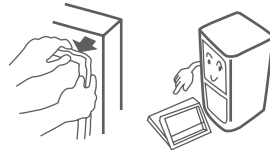

- ❖ Do not pull the plug of the refrigerator by pulling on the power cord. When the refrigerator is moved away from the wall, please operate carefully. Do not roll over or damage the power cord. Do not continue to use when the power line is damaged or the plug is worn, and must be replaced by the repair point designated by the manufacturer.

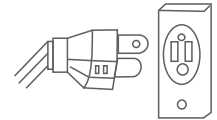

- ❖ Before cleaning and maintenance, please unplug the power to avoid electric shock.



SAVE THESE INSTRUCTIONS

SAFETY WARNINGS

- ❖ Strictly prohibit self dismantling and transforming the refrigerator as well as damaging the refrigerant line of refrigerator. When it is found that the refrigerant line is damaged or the combustible gas has leaked, the leakage valve should be closed, the doors and windows should be opened and the repair points specified by the manufacturer should be contacted in time.
- ❖ Glass bottles or cans with liquid in them should not be placed in the freezer to prevent bursting.
- ❖ Watch out for children and make sure they don't play in the refrigerator. Besides, do not let anyone climb, sit, stand or lean on the refrigerator door.
- ❖ Do not touch the cold surface of the freezer, otherwise it may cause frostbite easily due to low temperature.

⚠ Note: the spark generated by pulling the plug of the power supply may ignite the leaked gas.



This symbol alerts you to take care as the appliance contains a flammable refrigerant. Do not expose it to high heat, sparks or open flames

CAUTION:
Flammable Gas

USE METHOD AND PRECAUTIONS OF DIFFERENT COMPARTMENTS

TIPS FOR USE OF REFRIGERATOR COMPARTMENT

1. The common refrigerating temperature of food stored in refrigerator is from 39°F to 46°F. In this environment, cooked meat can not be stored for more than 4 days, and fruits and vegetables should not exceed one week at most.
2. Raw meat and seafood need to be packed in different containers and stored for not more than 3 days.
3. Raw food and cooked food need to be stored in different containers. In order to prevent bacterial contamination, raw vegetables and fruits should not be exposed to raw meat or fish. Vegetables and fruits should be wrapped by film and stored in the crisper.
4. Before freezing food, wrap in freezer safe cling, bag or container. The temperature of freezer is -0.4°F, In order to make sure they taste fresh and delicious, and to look in the nutrition of food, the food in the freezer should not be stored for more than three months.

SAVE THESE INSTRUCTIONS

PRODUCT INTRODUCTION

HANDLING AND PLACEMENT

The refrigerator should be placed on a flat and solid surface. Do not use the foam pad of the refrigerator to make it higher. If there is a slight instability, the adjustable feet at the front of the refrigerator can be adjusted. Rotate the adjustable foot clockwise to raise the height of the refrigerator and reduce the height by counterclockwise.

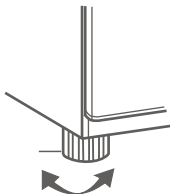

Refrigerator should not be placed in wet places. If the refrigerator is accidentally splashed with water or other dirt, please clean it with a soft cloth.

- ❖ Do not place in area that gets below 41°F and do not use in area that will get wet.
- ❖ Please pull the power plug and remove all the food in the fridge when handling.
- ❖ Use tape to fix the movable parts of refrigerator, like glass shelves of fridge, vegetable crisper and freezer drawer. Close the door and fix it with adhesive tape so as not to be opened when moving.
- ❖ Do not hold the handles to move the refrigerator in the process of transportation. You should lift the refrigerator from the bottom.

- ❖ Refrigerator should be placed in a dry, well ventilated place. The sides and back of the refrigerator should be retained more than 1/4 inch of space, and the top to retain more than 1 inch of space.
- ❖ Refrigerator should be placed far away from any heat source and space of direct sunlight, so as not to affect the performance of the refrigerator.

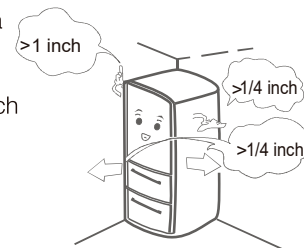

- ❖ It is not appropriate to lift sideway or reverse the refrigerator during the handling. If you have to tilt, the inclination between the cabinet and the ground should not be less than 45 degrees. Do not use the mobile pulley on the prone scratched floor, it may scratch the floor.
- ❖ The refrigerator you purchased uses R600a refrigerants that are very flammable. When you are transporting and placing the refrigerator, please avoid collisions or violent shocks to prevent damage of the refrigeration system or fire accidents.



PRODUCT INTRODUCTION

⚠ Note: Refrigerators cannot be transported upside down or laying flat. If they are transported incorrectly, refrigerators must be placed upright for 2 hours before they can be plugged in.

Responsible disposal of the appliance

At the end of its working life, do not throw this appliance out with your household trash. Electrical and electronic appliances contain materials and substances which, if handled or disposed of incorrectly, could be potentially hazardous to the environment and human health.

Observe any local regulations regarding the disposal of electrical consumer goods and dispose of it appropriately for recycling and recovery of the refrigerant. This appliance contains the flammable refrigerant isobutane (R600a) and cyclopentane (R141b) in the cabinet insulation, and must be disposed of in a separate waste collection. Contact your local authorities for advice on recycling facilities in your area

Take care not to damage the pipework at the back of the appliance before or during transportation so that the refrigerant gas cannot escape. The plug must be rendered useless and the cable cut off directly behind the appliance or the machine to prevent misuse

DANGER. Risk of child entrapment: When discarding a refrigerator, make sure to take off the door and the spring action or bolt catch. Leave the shelves in place so that children cannot easily climb in, get trapped inside and suffocate.

INSTRUCTION FOR USAGE

- ❖ All the packaging components, including the foam pad (which cannot be used to make the refrigerator higher) and the adhesive tape used for fixing accessories, must also be removed. Check the accessories and information, as well as the items in the package according to the packing list in the instructions.
- ❖ After the power supply is switched on, the refrigerator will continue to work for a long time in order to reach the predetermined temperature. During this time, please try to reduce the number of times you open the doors. For the first and a longer working time, the noise of the refrigerator may be slightly louder, and the temperature of both sides may be higher. After a period of time, when the refrigerator is fully cooled, it can be used and put food into.

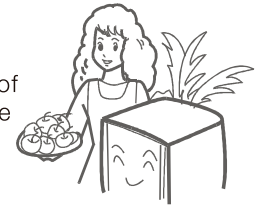
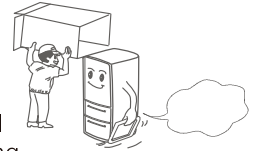

PRODUCT INTRODUCTION

- ❖ Please do not rush to connect the power supply after the stable placement and cleanness of the refrigerator. It should stand for at least 2 hours, and then switch on the power to ensure the normal operation of the refrigerator.
- ❖ Place the refrigerator in the right place (see the foregoing points for attention), and make a full cleaning of the refrigerator before use (refer to the latter section of cleaning methods).of the refrigerator.
- ⚠ **Note:** The power cord should not be pressed by the refrigerator itself and other heavy objects, so as to avoid damaging the power line and causing accidents.
- ❖ The temperature of refrigerating chamber is usually around 32-50°F, which is used to store fresh food for a short time, such as vegetables, fruits and beverages,etc..
- ❖ Refrigerated food should be wrapped in plastic wrap and placed evenly on the shelf to prevent taint of odor or excessive evaporation of moisture.
- ❖ The storage of goods in the refrigerating chamber should not be too dense. It should leave proper space for the cold air circulation.
Hot food should be cooled to room temperature and then put into the fridge.
- ❖ Radish or similar food should cut off leaves to prevent nutrition from being absorbed by leaves.
- ❖ The amount of fresh food placed in the freezer should not exceed the freezing capacity listed in the technical parameters of the refrigerator.
- ❖ Minimize the number of opening and closing times to reduce the loss of cold air. So that the storage period can be extended.
- ⚠ **Note:** It should be noted that food should not obstruct the air outlet when storing food, so as not to cause bad circulation of the cool air and affect the normal performance of the refrigerator.
- ❖ Frozen foods should not be refrozen after thawing. They should be eaten as quickly as possible.
- ❖ Use sealed packages or fresh-keeping bags to freeze food as far as possible, so that they can be stored for a longer time and can reduce freezer burn on the food chamber.
- ❖ After a loss of power, please reduce the number of open doors, and try not to put in the new food (to prevent the temperature in the cabinet to pick up faster).
- ❖ If a power outage is known change pick up to rise, you should make more ice cubes that placed in a watertight container, and put them in the upper of the refrigerating chamber.

PRODUCT INTRODUCTION

INSTRUCTION FOR USAGE

- ❖ When the refrigerator is not in use, please open the door to prevent the bad smell from the residue of the food in the refrigerator.
- ❖ The freezing drawer is used for storing something that need to be preserved for a long time, such as meat, fish and so on.
- ❖ Package the food to be frozen as flat as possible to facilitate freezing and thawing.
- ❖ After pulling off the power, it should be kept the refrigerator at least 5 minutes apart before it is reenergized. vertically, so that the storage period can be extended.
- ❖ The food that can be washed is best to be stored after cleaning and drying.
- ❖ If the refrigerator needs to be stopped for a long time, the power plug should be removed, the power should be cut off, and the refrigerator should be cleaned according to the method described above. In general, do not block up the refrigerator, otherwise it will affect the service life of the refrigerator.

USAGE

MAINTENANCE AND CLEANING

Defrost

- ❖ This product is frost-free refrigerator, and there is no need for manual defrosting.

Cleaning

- ❖ The refrigerator should be cleaned often to avoid unpleasant smells.
- ❖ Before cleaning, you must remove the plug.
- ❖ Use a soft towel or sponge dipped in warm water (neutral detergent can be added) to clean the cabinet except the door seal. When the door seal is cleaned, you must use rinsing and wipe it with dry cloth.

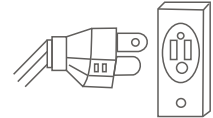

- ⚠ Note:** Do not spray the water directly when cleaning, so as not to affect the insulation performance of electrical components. Use a dry rag when cleaning electrical components such as switch and light.
- ⚠ Note:** Do not use hard brushes, wire brushes, detergents, gasoline, lacquer thinner, acetone and other organic solvents, hot water or acid, alkali to clean the refrigerator.

PRODUCT INTRODUCTION

DOOR HANDLE INSTALLATION

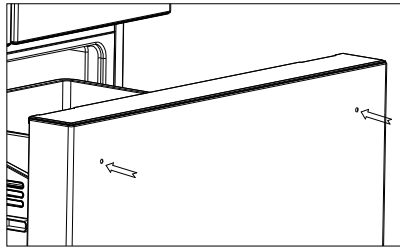

1. Before the refrigerator door handle is installed (note: the anchor bolts of the handle are in the accessory bag, and all steps should be performed at the right and left two mounting positions simultaneously).

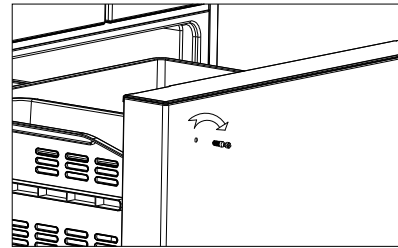

2. Screw the locating bolt into the bolt hole of the door body and secure it.

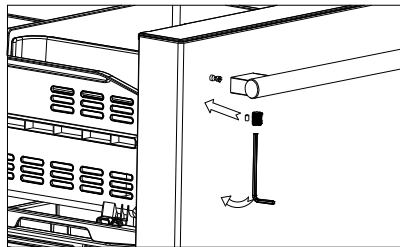

3. Loosen the locking screw inside the handle part with a hexagonal wrench first, then align the handle with the positioning bolt and insert it into the positioning bolt (note: the handle locking screw is installed facing down).

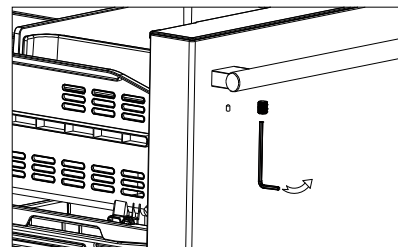

4. Wait until the handle fits perfectly with the door body, and then use a hexagonal wrench to tighten the locking screw inside the handle part.

INSTRUCTION FOR USAGE

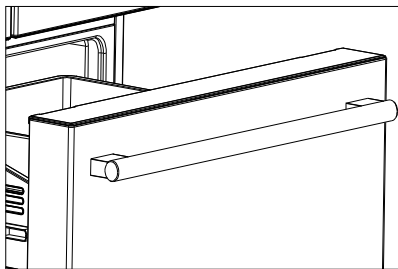

5. Finish installing the handle.

Installing door bin:

tray off upward.

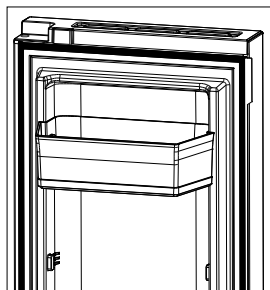
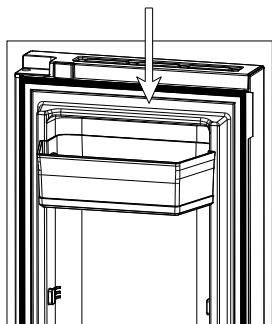

1. Place the tray above the mounting position and force the door up to the bottom, completing the installation when it cannot continue to move down.

Door Mullion

When the door mullion is positioned unfolded as illustrated in figure 1, the door will not close properly. Please fold the door mullion inside as shown in figure 2 before closing the door. In order to prevent damage, do not try to close the door when the mullion is unfolded as shown in figure 1.

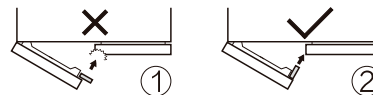

! **Notice:** in order to prevent condensation, the door mullion is provided with heater for heating. Door mullion heating is normal phenomenon and has no effect on frozen food.

CONNECT WATER SUPPLY (GLR18FS5S16)

What you need:

1. Basic tools: adjustable wrench, flat blade screwdriver, and Phillips TM screwdriver.
2. Access to a household cold water line with water pressure between 20 and 120 psi.
3. A water supply line made of 1/4 inch (6.4 mm) OD, copper tubing, PVC or Braided Stainless. To determine the length of connector needed, you will need to measure the distance from the ice maker inlet valve at the back of the refrigerator to your cold water pipe. Then add approximately 7 feet (2.1 meters), so the refrigerator can be moved out for cleaning.
4. A shutoff valve to connect the water supply line to your household water system. DO NOT use a self-piercing type shutoff valve.
5. A compression nut and ferrule (sleeve) for connecting the water supply line to the ice maker inlet valve.

NOTE: Before making the connection to the refrigerator, be sure that the refrigerator power cord is not plugged into the wall outlet.

1. Place end of water supply line into sink or bucket. Turn On water supply and flush supply line until water is clear. Turn OFF water supply at shut off valve.
2. Remove the plastic flexible cap from the water valve inlet.
3. Place the compression nut and ferrule (sleeve) onto the end of the tubing.
4. Insert the end of the water supply line into the connection as far as possible. While holding the tubing, tighten the fitting.

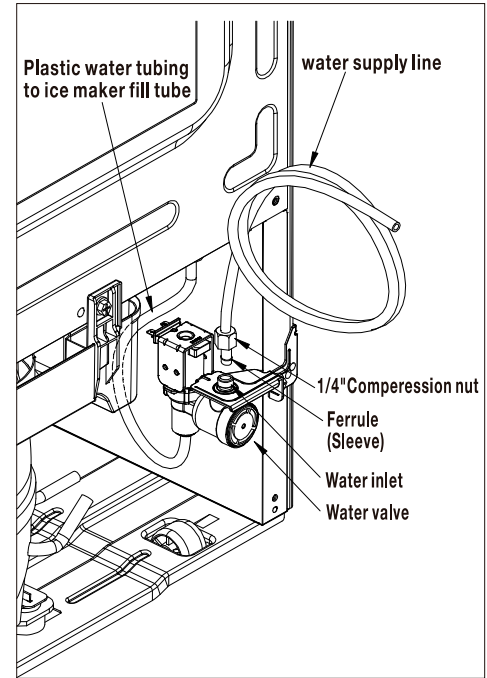

5. Turn ON water supply at shutoff valve and tighten any connections that leak.

WARNING: Connect to potable water supply only.

USAGE

Ice Maker (on some models)

After turning on your refrigerator, the ice will start to be made between 12 and 24 hours.

The ice maker produces 3.5 lbs ice per day, depending on the temperature of the freezer, the times in which the door opens, and other conditions (amount of food in the freezer, etc).

In order to turn on/off the ice maker, press the power button for 2 seconds.

The ice maker will fill up (and start making ice) between 12 and 24 hours after the refrigerator is turned on.

Throw away the first batch of ice. Make sure that nothing interferes with the sensor.

When the ice reaches the sensor, the ice maker will stop making ice immediately.

It's normal that some ice gets stuck. If the ice is not used frequently, the older cubes of ice will be opaque in color, smaller, and with a strange flavor.

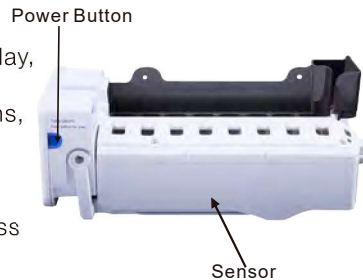

The ice maker is not producing ice or not enough ice.

- If it is new installation. Wait 12 to 24 hours after icemaker installation for ice production to begin. It will take 72 hours for full ice production.
- Check if the refrigerator is connected to a water supply or the supply shut off valve is turned on.
- Reverse osmosis filtration systems can reduce the water pressure below the minimum amount and result in icemaker issues.
- A kink in the line can reduce water flow. Straighten the water source line.
- Confirm ice maker is in the ON position.
- The recommended temperature for the freezer compartment for normal ice production is 0°F. If the freezer temperature is warmer, ice production will be affected.
- If the doors are not properly closed, ice production will be affected.

INSTRUCTION FOR USAGE

BUTTON INSTRUCTION OF DISPLAY

- ❖ The below picture is a schematic diagram of an electronic display.

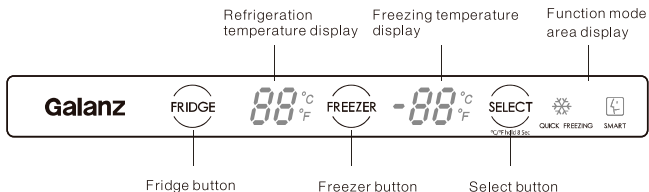

Button instruction

- ❖ “Fridge” button: adjust the setting temperature of refrigerating chamber (press down is effective).
- ❖ “Freezer” button: adjust the setting temperature of freezing chamber (press down is effective).
- ❖ “Select” button: with each click (within 5 seconds), the corresponding function icon flickers, and then switch among quick freezing- intelligence successively (press down is effective). No operation within 5 seconds will end.
- ❖ Press “SELECT” for 8 seconds, temperature display unit to the operation done mentioned earlier, can be switched to Celsius or Fahrenheit, light of “°C / °F” will be turned on according to the operation done mentioned earlier.

THE SETTING OF THE REFRIGERATOR COMPARTMENT

- ❖ The LED display turns bright when the door is open. Push the “Fridge” button. The buzzer rings. Then the refrigerating room turns into the setting condition. The temperature patterns turns flash and the temperature of the refrigerating room increase 1. The temperature will recycles as “33” — “45”.

! Warning: The temperature will be set finally and the flash will disappear without setting operation over 5 seconds.

THE SETTING OF THE FREEZING ROOM

- ❖ The LED display turns bright when the door is open. Push the “freezer” button. The buzzer rings. Then the freezing room turns into the setting condition. The temperature turns flash and the temperature of the freezing room increase 1. It will recycle from “5” — “-8”.

! Warning: The temperature will be set successfully and the flash will disappear if stop setting over 5 seconds.

INSTRUCTION FOR USAGE

The setting of the functions

- ❖ The LED display turns bright when the door is open. Push the "Select" button. Then it turns into the condition of setting functions.
- ❖ Entering the quick freezing mode: Push the "Select" button.
▶ Flashing 5 times When the quick freezing pattern turns bright, it is in the quick freezing mode.
- ❖ Exiting the quick freezing mode: Push the "Select" button.
▶ Disappear When the quick freezing pattern disappears, it is exiting the quick freezing mode.
- ❖ Note: In quick freezing mode, the temperature of freezer room is fixed at low temperature, and it cannot be regulated. It will exit the quick freezing mode within 24 hours after finishing freezing.
- ❖ Entering the smart mode: Push the "Select" button.
▶ Flashing 5 times When the smart pattern turns bright, it is in the smart mode.
- ❖ Exiting the smart mode: Push the "Select" button.
▶ Disappear When the smart pattern disappears, it is exiting the smart mode.

Note: In the smart mode, the temperature of refrigerator and freezer change as the change of the environmental temperature and regulate the temperature automatically.

Warning Push the "Select" button, exit the smart mode, and all selects pattern disappear, then it exit the setting of select modes. regulate the temperature automatically.

- ❖ The zone shown is for humidity adjustment. Users can slide the module left or right in accordance with the food situation. When the module locates in the "LOW" side, the humidity is low in crisper. When the module locates in the "HIGH" side, the humidity is high in crisper.

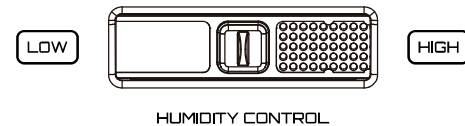

INSTRUCTION FOR USAGE

LIGHTING AND ITS REPLACEMENT

- ❖ When the door of refrigerating chamber opens, the LED light turns on.
- ❖ When the lighting is damaged, please remove the lampshade first and then replace the LED lighting.
- ❖ The specific operations are shown in the following diagram:



1. Please move the lampshade and the thermostat out 3-5mm in the direction of the arrow.

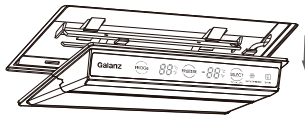

2. Take out the lamp shade and thermostat downwards, the arrow.

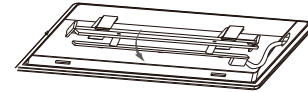

3. Pull the connection terminal, use the screwdriver to remove the LED light board and replace it.

⚠ Note: If the LED lamp is abnormal, it should be replaced by professionals. Do not take dismantling and replace it privately in order to avoid damage.

TROUBLESHOOTINGS

❖ The refrigerator doesn't work.



Is the refrigerator power connected (plugs, sockets.)?



Is the supply voltage too low?

❖ There is an unusual smell in the refrigerator.

- ◆ Is the odorous food wrapped tightly?
- ◆ Check whether there is any spoiled food.
- ◆ The interior of the refrigerator needs cleaning.

❖ The temperature inside the cabinet is not low enough.

- ◆ Door not closed tightly, frequent opening of the door, door left open for too long, air outlet is blocked by food.
- ◆ The position of refrigerator is either under the direct sunlight or near the stove, heater and other heat producing appliances.
- ◆ Poor ventilation, the sides or backboard blocked by something or too dirty of the cabinet.
- ◆ Setting the temperature too high will cause the temperature inside the cabinet not to be low enough.

⚠ Note: If detected by the above method, your refrigerator is still abnormal, please contact our after-sales service department or local authorized maintenance department in time.

❖ Lighting doesn't work.



Is LED lamp (bulb) damaged?



Is the refrigerator power connected (plugs, sockets, insurance, etc.)?

❖ Compressor runs for a long time.

- ◆ This is a normal phenomenon for a long time operation when used for the first time.
- ◆ Put a large number of food that needs to be refrigerated or frozen at a time.
- ◆ The weather is hot and the environment temperature is too high.
- ◆ Open the refrigerator door frequently.
- ◆ The refrigerator door is not closed tightly.
- ◆ Low temperature is set.

❖ The refrigerator is noisy when running.

- ◆ Is the floor flat? Does the refrigerator place stably?
- ◆ A part of the refrigerator is whether exposed to external objects or walls.

SPECIFICATIONS AND PARAMETERS

SPECIFICATIONS AND PARAMETERS

Climate class		T
Electric shock protection type		I
Capacity(cu.ft)		18
Voltage(V)		120
Frequency(Hz)		60
Current(A)		1.8
Voice [dB(A)]		≤ 42
Refrigerant		R600a/2.47oz
Weight(lbs)		219.36
Interior temperature (°F)	Freezer	-8~5
	Refrigerator	33~45
Dimension(inch)	Width	32.30
	Depth	27.30
	Height	70.00

PACKING LIST

PARTS	NUMBER
Door bin	8pcs
Crisper	2pcs
Freezer upper drawer	1pcs
Freezer lower drawer	1pcs
Glass shelf	2pcs
Ice Bucket	1pcs
Owner's manual	1pcs
Handle with base	3pcs
Screw for handle	6pcs

LIMITED WARRANTY

LIMITED WARRANTY

IN-HOME SERVICE FULL ONE YEAR WARRANTY

For 12 months from the date of original retail purchase, Galanz will repair or replace any part free of charge, including labor, that fails due to a defect in materials or workmanship. Galanz may replace or repair at their sole discretion any part, or sub system including the entire product. Product must be accessible, without encumbrance and installed properly to receive warranty repair service.

LIMITED WARRANTY

NOTE: This warranty commences on the date the item was purchased, or ownership assumed from a builder and the original purchase receipt must be presented to the authorized service representative before warranty repairs are rendered.

Exceptions:Commercial Use Warranty

90 days labor from date of original purchase

90 days parts from date of original purchase

No other warranty applies.

FOR WARRANTY SERVICE

All service must be performed by a Galanz authorized service .

For service, please call 1-800-562-0738. Before calling please have available the following information: (a) Model number and serial number of your appliance. (b) The name and address of the dealer you purchased the unit from and the date of purchase. (c) A clear description of the problem. (d) A proof of purchase (sales receipt).

This warranty covers home appliance services within the contiguous United States and where available in Alaska, Hawaii and Puerto Rico.

What is not covered by this warranty:

Replacement or repair of household fuses, circuit breakers, wiring or plumbing. A product whose original serial number has been removed or altered. Any service charges not specifically identified as normal such as normal service area or hours.

Replacement of light bulbs.

Damage to clothing.

Damage incurred in shipping.

Damage caused by improper installation or maintenance.

Damage from misuse, abuse accident, fire, flood, or acts of nature.

Damage from service other than an authorized Galanz dealer or service center.

Damage from incorrect electrical current, voltage or supply.

Damage resulting from any product modification, alteration or adjustment not authorized by Galanz.

Adjustment of consumer operated controls as identified in the owner's manual.

Hoses, knobs, lint trays and all attachments, accessories and disposable parts.

Labor, service transportation, and shipping charges for the removal and replacement of defective parts beyond the initial 12-month period.

Damage from other than normal household use.

Any transportation and shipping charges.

THIS LIMITED WARRANTY IS GIVEN IN LIEU OF ALL OTHER WARRANTIES, EXPRESS OR IMPLIED, INCLUDING BUT NOT LIMITED TO, THE WARRANTIES OF MERCHANTABILITY AND FITNESS FOR A PARTICULAR PURPOSE

The remedy provided in this warranty is exclusive and is granted in lieu of all other remedies.

This warranty does not cover incidental or consequential damages, so the above limitations may not apply to you.

Some states do not allow limitations on how long an implied warranty lasts, so the above limitations may not apply to you.

This warranty gives you specific legal rights, and you may have other rights, which vary from state to state.

WARRANTY REGISTRATION

Please mail this warranty card to the address below within 30 days of purchase.
Galanz Americas, 55 Challenger Road, Suite 503, Ridgefield Park, NJ 07660.

PLEASE PRINT CLEARLY.

Name _____

Address _____

City _____ State _____ ZIP _____

Phone _____ Email _____

Model Number _____ Serial Number _____

Purchase Location _____

You must attach a copy of your purchase receipt to validate your registration.

Galanz