

# Microwave Oven

## *use & care*

Introduction . . . . .	2
Precautions Microwave Energy . . . . .	3
Important Safety Instructions . . . . .	4-7
Names Of Oven Parts And Accessories . . . . .	8
Operation . . . . .	9-17
Maintenance . . . . .	18

Cleaning And Care . . . . .	19-21
Service Call Check . . . . .	22
Warranty . . . . .	23

# 2

## INTRODUCTION

---

Welcome to our *family*

Thank you for bringing Frigidaire into your home! We see your purchase as the beginning of a long relationship together.

This manual is your resource for the use and care of your product. Please read it before using your appliance. Keep it handy for quick reference. If something doesn't seem right, the troubleshooting section will help you with common issues.

FAQs, helpful tips and videos, cleaning products, and kitchen and home accessories are available at [www.frigidaire.com](http://www.frigidaire.com).

We are here for you! Visit our website, chat with an agent, or call us if you need help. We may be able to help you avoid a service visit. If you do need service, we can get that started for you.

Let's make it official! Be sure to register your product.

Keep your product info here so it's easy to find.

Model Number: \_\_\_\_\_

Serial Number: \_\_\_\_\_

Purchase Date: \_\_\_\_\_

Let's make it official! Be sure to register your product.

Visit us at [Frigidaire.com/register](http://Frigidaire.com/register)

Or use your mobile device to scan the QR code.

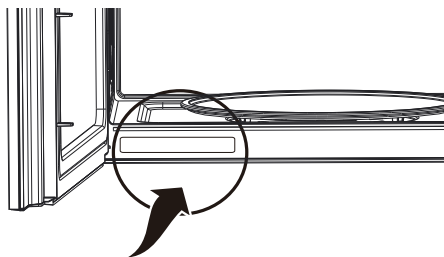

Serial Number Location

---

## PRECAUTIONS TO AVOID POSSIBLE EXPOSURE TO EXCESSIVE MICROWAVE ENERGY

Do not attempt to operate this oven with the door open since open door operation can result in harmful exposure to microwave energy. It is important not to defeat or tamper with the safety interlocks.

Do not place any object between the oven front face and the door or allow soil or cleaner residue to accumulate on sealing surfaces.

### **WARNING**

To reduce the risk of burns, electric shock, fire, injury to persons or exposure to excessive microwave energy:

Do not operate the oven if it is damaged. It is particularly important that the oven door close properly and that there is no damage to the:

- (1) DOOR (bent)
- (2) HINGES AND LATCHES (broken or loosened)
- (3) DOOR SEALS AND SEALING SURFACES.

The oven should not be adjusted or repaired by anyone except properly qualified service personnel.

**This device complies with part 18 of the FCC Rules. (Only for USA)**

## RADIO INTERFERENCE

- Operation of the microwave oven may cause interference to your radio, TV or similar equipment.
- When there is interference, it may be reduced or eliminated by taking the following measures:
  - Clean door and sealing surface of the oven.
  - Reorient the receiving antenna of radio or television.
  - Relocate the microwave oven with respect to the receiver.
  - Move the microwave oven away from the receiver.
  - Plug the microwave oven into a different outlet so that microwave oven and receiver are on different branch circuits.

## UTENSILS

### **CAUTION**

- Personal Injury Hazard

- Tightly-closed utensils could explode. Closed containers should be opened and plastic pouches should be pierced before cooking.
- See the instructions on "Materials you can use in microwave oven or to be avoided in microwave oven."

There may be certain non-metallic utensils that are not safe to use for microwaving. If in doubt, you can test the utensil in question following the procedure below.

### **Utensil Test:**

- Fill a microwave-safe container with 1 cup of cold water (250ml) along with the utensil in question.
- Cook on maximum power for 1 minute. Carefully feel the utensil. If the empty utensil is warm, do not use it for microwave cooking.
- Do not exceed 1 minute cooking time.

**SAVE THESE INSTRUCTIONS**

# 4 IMPORTANT SAFETY INSTRUCTIONS

---

Read all instructions before using this appliance.

This manual contains important safety symbols and instructions. Please pay attention to these symbols and follow all instructions given.

Do not attempt to install or operate your appliance until you have read the safety precautions in this manual. Safety items throughout this manual are labeled with a WARNING or CAUTION statement based on the risk type.

Warnings and important instructions appearing in this guide are not meant to cover all possible conditions and situations that may occur. Common sense, caution, and care must be exercised with installing, maintaining, or operating your appliance.

## DEFINITIONS

 This is the safety alert symbol. It is used to alert of potential personal injury hazards. Obey all safety messages that follow this symbol to avoid possible injury or death.

### WARNING

Indicates a potentially hazardous situation which, if not avoided, may result in death or serious injury.

### CAUTION

Indicates a potentially hazardous situation which, if not avoided, may result in minor or moderate injury.

### NOTE

Indicates a short, informal reference - something written down to assist the memory or for future reference.

### IMPORTANT

Indicates installation, operation or maintenance information which is important but not hazard-related.

### NOTE

## ELECTRICAL REQUIREMENTS

Product rating is 120 volts AC, 60 Hertz, 1.5 kilowatts and 13.5 amps. This product must be connected to a separate and dedicated supply circuit of the proper voltage and frequency. Wire size must conform to the requirements of the National Electrical Code or the prevailing local code for this kilowatt rating. The power supply cord and plug should be brought to a separate and dedicated 15- to 20-ampere branch circuit single grounded outlet. The outlet box should be located in the cabinet above the microwave oven. The outlet box and supply circuit should be installed by a qualified electrician and conform to the National Electrical Code or the prevailing local code.

### IMPORTANT

1. If you have any questions about the grounding or electrical instructions, consult a qualified electrician or service person.
2. Neither Electrolux nor the dealer can accept any liability for damage to the microwave oven or personal injury resulting from failure to observe the correct electrical connection procedures.

---

## SAVE THESE INSTRUCTIONS

When using electrical appliances basic safety precautions should be followed, including the following:

## **WARNING**

To reduce the risk of burns, electric shock, fire, injury to persons or exposure to excessive microwave energy:

- Read all instructions before using the appliance.
- Read and follow the specific: "PRECAUTIONS TO AVOID POSSIBLE EXPOSURE TO EXCESSIVE MICROWAVE ENERGY" found on page 3.
- This appliance must be grounded. Connect only to properly grounded outlet. See "GROUNDING INSTRUCTIONS" found on page 6.
- Install or locate this appliance only in accordance with the provided installation instructions.
- Some products such as whole eggs and sealed containers - for example, closed glass jars - are able to explode and should not be heated in this oven.
- Use this appliance only for its intended use as described in the manual. Do not use corrosive chemicals or vapors in this appliance. This type of oven is specifically designed to heat, cook or dry food. It is not designed for industrial or laboratory use.
- **HOT CONTENTS CAN CAUSE SEVERE BURNS. DO NOT ALLOW CHILDREN TO USE THE MICROWAVE.** Use caution when removing hot items.
- Do not operate this appliance if it has a damaged cord or plug, if it is not working properly, or if it has been damaged or dropped.
- This appliance should be serviced only by qualified service personnel. Contact nearest authorized service facility for examination, repair, or adjustment.
- Do not cover or block any openings on the appliance.
- Do not store this appliance outdoors. Do not use this product near water - for example, near a kitchen sink, in a wet basement, near a swimming pool, or similar location.
- Do not immerse cord or plug in water.
- Keep cord away from heated surface.
- Do not let cord hang over edge of table or counter. When cleaning surfaces of door and oven that comes together on closing the door, use only mild, nonabrasive soaps, or detergent applied with a sponge or soft cloth.
- To reduce the risk of fire in the oven cavity:
  - Do not overcook food. Carefully attend appliance when paper, plastic, or other combustible materials are placed inside the oven to facilitate cooking.
  - Remove wire twist-ties from paper or plastic bag before when placing bag in oven.
  - If material inside of the oven ignite, keep oven door closed, turn oven off, and disconnect the power cord, or shut off power at the fuse or circuit breaker panel.
  - Do not use the cavity for storage purposes. Do not leave paper products, cooking utensils, or food in the cavity when not in use.
- Liquids, such as water, coffee, or tea are able to be overheated beyond the boiling point without appearing to be boiling. Visible bubbling or boiling when the container is removed from the microwave oven is not always present. **THIS COULD RESULT IN VERY HOT LIQUID SUDDENLY BOILING OVER WHEN THE CONTAINER IS DISTURBED OR A UTENSIL IS INSERTED INTO THE LIQUID.** To reduce the risk of injury to persons:
  - Do not overheat the liquid.
  - Stir the liquid both before and halfway through heating it.
  - Do not use straight-sided containers with narrow necks.
  - After heating, allow the container to stand in the microwave oven for a short time before removing the container.
  - Use extreme care when inserting a spoon or other utensil into the container.
  - Oversized food or oversized metal utensils should not be inserted in a microwave oven as they may create a fire or risk of electric shock. Do not clean with metal scouring pads. Pieces can burn off the pad and touch electrical parts involving a risk of electric shock.
  - Do not store any materials, other than manufacturer's recommended accessories, in this oven when not in use.
  - Do not cover racks or any other part of the oven with metal foil. This will cause over- heating of the oven.
  - Clean Ventilation Hoods Frequently -Grease should not be allowed to accumulate on hood or filter.
  - When flaming foods under the hood, turn the fan on.
  - Use care when cleaning the vent-hood filter. Corrosive cleaning agents, such as lye-based oven cleaners, may damage the filter.
  - Suitable for use above both gas and electric cooking equipment.

## SAVE THESE INSTRUCTIONS

# 6 IMPORTANT SAFETY INSTRUCTIONS

## GROUNDING INSTRUCTIONS

This appliance must be grounded. In the event of an electrical short circuit, grounding reduces the risk of electric shock by providing an escape wire for the electric current. This appliance is equipped with a cord having a grounding wire with a grounding plug. The plug must be plugged into an outlet that is properly installed and grounded.

### WARNING

Improper use of the grounding can result in a risk of electric shock.

Consult a qualified electrician or serviceman if the grounding instructions are not completely understood, or if doubt exists as to whether the appliance is properly grounded. If it is necessary to use an extension cord, use only a 3-wire extension cord that has a 3-blade grounded plug, and 3-slot receptacle that will accept the plug on the appliance. The marked rating of the extension cord shall be equal to or greater than the electrical rating of the appliance.

### IMPORTANT

1. If you have any questions about the grounding or electrical instructions, consult a qualified electrician or service person.
2. Neither Electrolux nor the dealer can accept any liability for damage to the microwave oven or personal injury resulting from failure to observe the correct electrical connection procedures.

### DANGER

#### Electric Shock Hazard

Touching some of the internal components can cause serious personal injury or death. Do not disassemble this appliance.

### WARNING

#### Electric Shock Hazard

Improper use of the grounding can result in electric shock. Do not plug into an outlet until appliance is properly installed and grounded.

- A short power supply cord is provided to reduce the risks resulting from becoming entangled in or tripping over a longer cord.
- Longer cord sets or extension cords are available and may be used if care is exercised in their use.
- If a long cord or extension cord is used:
  - The marked electrical rating of the cord set or extension cord should be at least as great as the electrical rating of the appliance.
  - The extension cord must be a grounding-type 3-wire cord.
  - The longer cord should be arranged so that it will not drape over the counter top or tabletop where it can be pulled on by children or tripped over unintentionally.

**SAVE THESE INSTRUCTIONS**

## Materials you can use in microwave oven

Browning dish	Follow manufacturer instructions. The bottom of browning dish must be at least 3/16 inch (5mm) above the turntable. Incorrect usage may cause the turntable to break.
Dinnerware	Microwave-safe only. Follow manufacturer's instructions. Do not use cracked or chipped dishes.
Glass jars	Always remove lid. Use only to heat food until just warm. Most glass jars are not heat resistant and may break.
Glassware	Heat-resistant oven glassware only. Make sure there is no metallic trim. Do not use cracked or chipped dishes.
Oven cooking bags	Follow manufacturer instructions. Do not close with metal tie. Make slits to allow steam to escape.
Paper plates and cups	Use for short term cooking/warming only. Do not leave oven unattended while cooking.
Paper towels	Use to cover food for reheating and absorbing fat. Use with supervision for a short-term cooking only.
Parchment paper	Use as a cover to prevent splattering or a wrap for steaming.
Plastic	Microwave-safe only. Follow the manufacturer instructions. Should be labeled "Microwave Safe". Some plastic containers soften, as the food inside gets hot. "Boiling bags" and tightly closed plastic bags should be slit, pierced or vented as directed by package.
Plastic wrap	Microwave-safe only. Use to cover food during cooking to retain moisture. Do not allow plastic wrap to touch food.
Thermometers	Microwave-safe only (meat and candy thermometers).
Wax paper	Use as a cover to prevent splattering and retain moisture.







## Materials to be avoided in microwave oven









Aluminum tray	May cause arcing. Transfer food into microwave-safe dish.
Food carton with metal handle	May cause arcing. Transfer food into microwave-safe dish.
Metal or metal-trimmed utensils	Metal shields the food from microwave energy. Metal trim may cause arcing.
Metal twist ties	May cause arcing and could cause a fire in the oven.
Paper bags	May cause a fire in the oven.
Plastic foam	Plastic foam may melt or contaminate the liquid inside when exposed to high temperature.
Wood	Wood will dry out when used in the microwave oven and may split or crack.









# 8

## NAMES OF OVEN PARTS AND ACCESSORIES

PRESS AGAIN FOR OPTIONS/ PRESS START

TIMER  -  -  -  -  -  -  -  -  - 

DEFR.  -  -  -  -  -  -  -  -  - 

LOCK  -  -  -  -  -  -  -  -  - 

FILTER                      SENSOR COOK kg oz lb

Potato    Veggies    Sensor Cook

Melt Soften    Reheat    Defrost

Popcorn    Timer    Power Level





1 — 2 — 3  
Quick Start

4 — 5 — 6

7      8      9

STOP      0      START  
Cancel  
Hold 3s to lock

+10 Sec                      +30 Sec

              
Hold 3s ON/OFF

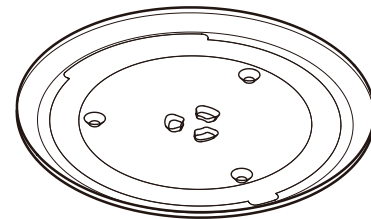

Glass turntable

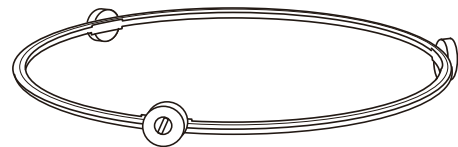



Turntable Ring Assembly



1. Before operating your new oven make sure you read and understand this Use and Care Guide completely.
2. Before the Built-in Convention Microwave Oven can be used, follow these procedures:
  - Plug in the oven. Close the door. The oven display will flash 12:00 ENTER TIME.
  - If no operation after 1 minute, the oven will show 12:01.
3. Set clock. See below.



## SETTING THE CLOCK

**Example: setting clock display for 9:00:**



1. Touch  pad once. 
2. Enter time using number pads. **9 0 0**
3. Touch START pad. **START**

## SETTING THE CLOCK ON/OFF

**Example: to turn off clock display:**

1. Touch  and hold pad . 
2. Time will display, after 3s, OFF will display. **oFF**

**Example: to turn on clock display:**

1. Clock key (short press <1sec) to enter the clock query state, display "current clock" for 3 seconds and then return to standby mode, the clock is not displayed; 
2. Hold Clock button 3s, at beginning, clock will be displayed then display ON, then display clock again. 

## SETTING THE TIMER

**Example: setting timer for 5 minutes:**

1. Touch Timer pad once. **Timer**
2. Enter desired time using number pads. **5 0 0**
3. Touch Timer pad. **Timer**

Timer count down does not stop even if the door is opened. To stop/cancel the timer, press the Timer key once. When the timer has reached the end of set time, you will hear beep alerts indicating the timer has run out.

### NOTE

The display will return to default after 15 minutes if a cooking cycle is stopped and not restarted.

## EXHAUST HIGH / MED / LOW / OFF

The exhaust ventilation removes steam and other cooking vapors from the cooking surface of the range below the microwave oven.

To operate the exhaust vent, touch the Exhaust High/Med/Low/Off pad once for the highest speed setting. Touch the pad again to choose the Med speed setting, a 3rd time to choose the Low speed setting and a four times to turn the exhaust ventilation off. 

### NOTE

If the temperature gets too hot around the microwave oven, the fan in the exhaust vent hood will automatically turn on at the LOW setting to cool the oven. The fan will automatically turn off when the internal parts are cool. When this occurs, the vent cannot be turned off.

## SURFACE LIGHT HIGH / LOW / OFF

Touch the Surface Light High/Low/Off pad once to activate the surface light, the screen displays "HIGH". Continue to touch the Surface Light High/Low/Off pad, you can choose the LOW or OFF gear. 

# 10 OPERATION

## CONTROL LOCK

You may lock the control panel to prevent the microwave from being accidentally started or used by children.

The control lock feature is very useful when cleaning the control panel. The lock will prevent accidental programming when wiping the control panel clean.

### Example: to set the control lock ON:

Touch and hold the Stop/Cancel pad for more than 3 seconds. The Lock icon will appear in the display window along with a beep.

**STOP**  
Cancel  
Hold 3s to lock

### Example: to change the control lock from ON to OFF:

Touch and hold the Stop/Cancel pad for more than 3 seconds. The Lock icon will disappear in the display window.

**STOP**  
Cancel  
Hold 3s to lock

## USING READY SET

1 — 2 — 3  
Quick Start  
4 — 5 — 6

Microwave heating or cooking may be quickly set at 100% power level for 1 or 6 minutes. Use the number keys 1- 6 to choose the desired minutes of cook time (this option will only work using the 1-6 numeric pads):

### Example: to quickly heat for 2 minutes at 100% power:

Touch number pads 2 for desired minutes of cook time. **2**

### NOTE

the Ready Set function cannot be set when using the Defrost (by weight) feature.

### NOTE

“Food” will be displayed if a quick start cooking cycle is not selected within 5 minutes of placing food in the microwave. You must open then close the door again to clear “Food” from the display.

## HEATING WITH HIGH POWER LEVEL

### Example: to heat for 7 minutes at 100% power:

1. Use the number pads to enter desired heating time (cook time may be set up to 99 minutes and 99 seconds). **7 0 0**

2. Touch START pad. **START**

When heating has finished you will hear beeps and “End” will display.

## HEATING WITH LOWER POWER LEVELS

Using the highest power level to heat foods with does not always give the best results when some types of food need slower cooking, such as roasts, baked goods or custards. Your oven has nine other power levels you may choose.

### Example: to heat for 4 minutes at 70% power:

1. Use the number pads to enter desired heating time (cook time may be set up to 99 minutes and 99 seconds). **4 0 0**

2. Touch Power Level pad once for power level 10 (100% power). **Power Level**

3. Touch Power Level pad 3 times for power level to 7. PL-70 appears in the display (70 % power). **Power Level**

4. Touch START pad. **START**

When heating has finished you will hear beeps and “End” will display.

## VEGGIES

**Example: to cook for frozen veggies.**

1. Touch Veggies twice. Veggies
2. Touch START pad. **START**

The microwave will beep when finished and “End” will display.

TOUCH	DISPLAY	AMOUNT
Veggies x1	FRESH VEGGIES	1-4 cups
Veggies x2	FROZEN VEGGIES	1-4 cups

## USING THE STOP/CANCEL KEY

**This feature will let you quickly stop or cancel the cooking process.**

Touch the Stop/Cancel pad to:

**STOP**  
Cancel  
Hold 3s to lock

1. Erase if you have entered wrong information.
2. Cancel timer setting process.
3. Touch pad once to pause the oven temporarily during cooking. (Touch START pad again to resume cooking.) **START**
4. Return the time of day (clock) to the display after cooking cycle is completed.
5. Stop a program during cooking, touch twice.

## USING THE +10 SEC /+ 30 SEC KEY

**This feature will let you quickly start or add 10 or 30 seconds.**

Touch the +10 sec/+30 sec pad to : +10 Sec / +30 Sec

1. Start programmed cooking.
2. Start cooking for 10 seconds/30 seconds at 100% power level.
3. Extend cooking time in multiples of 10 seconds/30 seconds each time this pad is touched during microwave cooking.

**Example: to add 1 minute of cook time during 100% microwave cooking :**

Touch +30 pad twice. +30 Sec

## NOTE

“Food” will be displayed if a quick start cooking cycle or +10 Sec/+30 Sec key is pressed more than 5 minutes after the door of microwave oven is closed. You must open then close the door again to clear “Food” from the display.

## SETTING DEFROST

**Example: to defrost 1.0 lbs of meat.**

1. Touch Defrost pad once. MEAT will appear in the display. Defrost
2. Touch START pad to confirm. **START**
3. Use the numeric pads to input weight of food to defrost in pounds (10 = 1.0 lb.) **1 0**  
You may enter any weight from 0.1 to 6.0 lbs.
4. Touch START pad. **START**

When defrosting has finished you will hear beeps and “End” will display.

Touch	Display	Wight Range
Defrost x1	MEAT	0.1-6.0 lbs
Defrost x2	POULTRY	0.1-6.0 lbs
Defrost x3	FISH	0.1-6.0 lbs

# 12 OPERATION

## DEFROSTING TIPS

- When using the defrost weight feature, the weight entered should always be pounds (valid entries are from 0.1 to 6.0 pounds).
- Use both defrost weight and defrost time features for raw food items only. Defrosting gives best results when food to be thawed is a minimum of 0°F (taken directly from a true freezer). If the food has been stored in a refrigerator-freezer that does not maintain a temperature of 5° F or below, always program a lower food weight or lower cook time to prevent cooking the food.
- If the frozen food is stored outside the freezer for up to 20 minutes, enter a reduced cook time or weight.
- The shape of the package will alter the defrosting time. Shallow rectangular food packets defrost more quickly than a deep frozen block of food.
- Separate pieces as they begin to defrost. Separated frozen pieces of food defrost better.
- Shield warm areas of food with small pieces of foil if they start to become warm.
- You may use small pieces of aluminum foil to shield food items like chicken wings, leg tips and fish tails, but do not allow the foil to touch the oven cavity walls when defrosting.

## DEFROSTING SUGGESTIONS FOR MEATS

For best results, please read these suggestions when defrosting meats.

Meat	Normal amount	Suggestions
Roast beef or pork	2.5 to 6.0 lbs. (40 to 96 oz.)	Start with the food placed fat side down. After each stage, turn the food over and shield any warm portions with narrow strips of aluminum foil. Let stand, covered for 15-30 minutes.

Steaks, chops or fish	0.5 to 3.0 lbs (8 to 48 oz.)	After each stage, rearrange the food. If there are any warm or thawed portions of food, shield them with narrow flat pieces of aluminum foil. Remove any pieces of food that are nearly defrosted. Let stand, covered for about 5 to 10 minutes.
Ground meat	0.5 to 3.0 lbs (8 to 48 oz.)	After each stage, remove any pieces of food that are nearly defrosted. Let stand, covered with foil for 5 to 10 minutes.
Whole chicken	2.5 to 6.0 lbs. (40 to 96 oz.)	Remove giblets before freezing poultry. Start defrosting with the breast side down. After the 1st stage, turn the chicken over and shield any warm portions with narrow strips of aluminum foil. After the 2nd stage, again shield any warm portions with narrow strips of aluminum foil. Let stand, covered, for 30 to 60 minutes in the refrigerator.
Chicken pieces	0.5 to 3.0 lbs. (8 to 48 oz.)	After each stage, rearrange or remove any pieces of food that are nearly defrosted. Let stand for 10-20 minutes.

Sensor cooking has an electronic controlled sensor that detects the vapor (moisture and humidity) emitted from the food as it heats. The sensor adjusts the cooking times and power level for various foods and quantities automatically.

## Using Sensor Settings:

1. Be sure the exterior of the cooking container and the interior of the oven are dry. Wipe off any moisture with a dry cloth or paper towel.
2. The oven works with foods at normal storage temperature. For example, popcorn would be at room temperature.
3. More or less food than the quantity listed in the chart should be cooked following the guidelines in any micro-wave cookbook.
4. During the first part of SENSOR COOKING, food name will appear in the display. Do not open the oven door or press the  pad during this part of the cycle. The measurement of vapor will be interrupted. When the sensor detects the vapor emitted from the food, remainder of cooking time will appear. Door may be opened when remaining cooking time appears in the display. At this time, you may stir or season food, as desired.
5. If the sensor does not detect vapor properly when popping popcorn, the oven will turn off, and the correct time of day will be displayed. If the sensor does not detect vapor properly when cooking other foods, AN ERROR CODE E-04 will be displayed, and the oven will turn off.
6. Check food for temperature after cooking. If additional time is needed, continue to cook manually.

## COVERING FOODS:

Some foods cook better when covered.

1. Casserole lid.
2. Plastic wrap: Use plastic wrap recommended for microwave cooking. Cover dish loosely; allow approximately 1/2 inch to remain uncovered to allow steam to escape. Plastic wrap should not touch food.
3. Wax paper: Cover dish completely; fold excess wrap under dish to secure. If dish is wider than paper, overlap two pieces at least one inch to cover.

Be careful when removing any covering to allow steam to escape away from you.

## NOTES FOR SENSOR COOKING

1. The final cooking result will vary according to the food condition (e.g. initial temperature, shape, quality). Check food for temperature after cooking. If additional time is needed, continue to cook manually.
2. Stay near the oven while it's in use and check cooking progress frequently so that there is no chance of overcooking food.
3. When SENSOR COOKING is selected Turntable On is automatically set for optimum cooking.

## SENSOR COOK

You can cook foods by touching the sensor cook pad multiple times. You don't need to calculate cooking time or power level.

### Example: to cook frozen breakfast .

1. Touch Sensor Cook pad 4 times to choose the frozen breakfast. Sensor Cook
2. Touch START pad. START

## Sensor Cook chart

TOUCH	DISPLAY	AMOUNT
Sensor Cook x1	BACON	Select 1, 2 or 3 slices
Sensor Cook x2	FROZEN DINNER	10 oz./ 20 oz.
Sensor Cook x3	RICE	1-2 cups
Sensor Cook x4	FROZEN BREAKFAST	8-12 oz .

# 14 OPERATION

## REHEAT

**Example: to set reheat 1 cup soup/sauce.**

- |                              |        |
|------------------------------|--------|
| 1. Touch Reheat pad 2 times. | Reheat |
| 2. Touch START to confirm.   | START  |
| 3. Touch 1 for 1 cup.        | 1      |
| 4. Touch START.              | START  |

## Sensor Cook chart

TOUCH	DISPLAY	AMOUNT
Reheat x1	BEVERAGE	1-2 cups
Reheat x2	SOUP SAUCE	1-2 cups
Reheat x3	PIZZA	1-4 slices
Reheat x4	DINNER PLATE	1-2 plates
Reheat x5	CASSEROLE	10.5 oz
Reheat x6	ROLLS	1-3 pieces

## CONVENIENCE COOKING SUGGESTIONS

Convenience category	Amount	Suggestions
Beverage	1, 2 cups (8 oz, 16 oz)	Use a microwave-safe measuring cup or mug; do not cover. Place the beverage in the microwave. After heating, stir well. Let oven cool for at least 5 minutes before using again. Beverages heated with the beverage category may be very hot. Remove the container with care.

## MELT/ SOFTEN

The oven uses low power to melt and soften items. See the following table.

## Example: to melt 8 oz. of Cream Cheese.

- |                                   |             |
|-----------------------------------|-------------|
| 1. Touch Melt/Soften pad 4 times. | Melt Soften |
| 2. Touch START to confirm.        | START       |
| 3. Touch 8 for 8 oz.              | 8           |
| 4. Touch START pad.               | START       |

## MELT / SOFTEN CATEGORY

TOUCH	DISPLAY	AMOUNT	KEY
Melt Soften x 1	MELT BUTTER	1 stick 2 sticks	1 2
Melt Soften x 2	MELT CHOCOLATE	2 oz. 4 oz. 8 oz.	2 4 8
Melt Soften x 3	SOFTEN ICE CREAM	1 Pint 1.5 Quart	1 2
Melt Soften x 4	SOFTEN CREAM CHEESE	3 oz. 8 oz.	3 8

## SUGGESTED POWER LEVELS FOR COOKING

The 10 power levels available with this microwave will help you to adjust to the power output best suited for the food type you are preparing. As with any food preparation in the microwave, it is best to follow the microwave instructions that are printed on food packaging.

The table below provides suggested power levels for various types of food that you can be prepare in the microwave.

Power level	Microwave output	Use to prepare when:
10 High	100 %	<ul style="list-style-type: none"> <li>Boiling water.</li> <li>Cooking ground beef.</li> <li>Making candy.</li> <li>Cooking fresh fruits &amp; vegetables.</li> <li>Cooking fish &amp; poultry.</li> <li>Preheating browning dish.</li> <li>Reheating beverages.</li> <li>Cooking bacon slices.</li> </ul>

9	90 %	<ul style="list-style-type: none"> <li>Reheating meat slices quickly.</li> <li>Saute onions, celery &amp; green peppers.</li> </ul>
8	80 %	<ul style="list-style-type: none"> <li>All reheating.</li> <li>Cooking scrambled eggs.</li> </ul>
7	70 %	<ul style="list-style-type: none"> <li>Cooking breads &amp; cereal products.</li> <li>Cooking cheese dishes &amp; veal.</li> <li>Cakes, muffins, brownies &amp; cupcakes.</li> </ul>
6	60 %	<ul style="list-style-type: none"> <li>Cooking pasta.</li> </ul>
5	50 %	<ul style="list-style-type: none"> <li>Cooking meats &amp; whole poultry.</li> <li>Cooking custard.</li> <li>Cooking spare ribs, rib roast &amp; sirloin roast.</li> </ul>
4	40 %	<ul style="list-style-type: none"> <li>Cooking less tender cuts of meat.</li> <li>Reheating frozen packaged foods.</li> </ul>
3	30 %	<ul style="list-style-type: none"> <li>Thawing meat, poultry &amp; seafood.</li> <li>Cooking small quantities of food.</li> <li>Finish cooking casseroles, stew &amp; some sauces.</li> </ul>
2	20 %	<ul style="list-style-type: none"> <li>Softening butter &amp; cream cheese.</li> <li>Heating small amounts of food.</li> </ul>
1	10 %	<ul style="list-style-type: none"> <li>Softening ice cream.</li> <li>Raise yeast dough.</li> </ul>

## SUGGESTIONS FOR GETTING THE BEST RESULTS

To help you achieve the best possible results from your microwave oven, read the following suggestions below;

- **Storage temperature**

Foods taken from the freezer or refrigerator take longer to cook than the same foods would at room temperature.

- **Size**

Small pieces of food cook faster than large ones. Pieces similar in size and shape will cook more evenly when cooked together. For more even results, reduce the power levels when cooking large pieces of food.

- **Natural moisture**

Very moist foods cook more evenly because microwave energy heats water molecules very efficiently.

- **Stirring**

Stir foods such as casseroles and vegetable from the outside to the center to distribute the heat more evenly. This will allow the food to cook faster. Constant stirring is not necessary.

- **Turn over items**

Turn over foods such as pork chops, roasts or whole cauliflower halfway through the cook time. This will help to expose all sides equally to microwave energy.

- **Food placement**

Place delicate areas of food items, such as asparagus tips, toward the center of the turntable tray.

- **Food arrangement**

Arrange unevenly shaped foods, such as chicken pieces or salmon, with the thicker or meatier parts toward the outside of the turntable tray.

- **Let the food stand**

After removing the food from the microwave, cover the food with foil or a casserole lid and let it stand to finish cooking. This will help the food finish in the center and avoids overcooking the out edges. The length of stand time depends on the density and surface area of the food items.

- **Wrapping in paper towels or waxed paper**

Sandwiches and many other food types containing pre-baked bread should be wrapped prior to placing in the microwave to help prevent the food items from drying out while heating.

# 16 OPERATION

## POPCORN

### CAUTION

DO NOT leave microwave oven unattended while popping corn.

The popcorn feature lets you pop 3 different commercially packaged microwave popcorn sized bags. Use the table below to determine the setting to use.

TOUCH	DISPLAY
Popcorn x1	3.3 oz.
Popcorn x2	3.0 oz.
Popcorn x3	1.75 oz.

### Example: to pop a 3.0 oz. bag of popcorn automatically.

1. Touch Popcorn pad 2 times. Popcorn
2. Touch START pad.  
The microwave will beep when finished. **START**

### CONVENIENCE COOKING SUGGESTIONS

Convenience category	Amount	Suggestions
Popcorn	1.75, 3.0, 3.3 oz. 1 pkg.	Cook a single "microwave-only" bag of popcorn at a time. Use caution when removing and opening the hot popcorn bag from the oven. Let microwave oven cool down at least 5 minutes before using again.

## POTATO

The potato feature cooks 1 - 4 potatoes (cooking times based on 8 to 36 oz.) automatically.

### Example: to cook 1 - 4 potatoes automatically.

1. Touch Potato pad once. Potato
2. Touch START pad.  
The microwave will beep when finished. **START**

### NOTE

- Before cooking, pierce potatoes with fork several times.
- After cooking, let potatoes stand for 5 minutes.

### CONVENIENCE COOKING SUGGESTIONS

Convenience category	Amount	Suggestions
Potato	1, 2, 3, 4 potatoes 8, 16, 24, 36 oz.	Pierce each potato several times using a fork. Place on turntable in spoke-like fashion. After cooking, let stand for 3-5 minutes. Let oven cool for at least 5 minutes before using again. Use the START pad to increase cook time for larger potatoes.

## SETTING SOUND

### Example: to set sound OFF.

Touch:

Display Shows:



PRESS AGAIN FOR OPTIONS/ PRESS START  
VOLUME LOW

PRESS AGAIN FOR OPTIONS/ PRESS START  
VOLUME MED

PRESS AGAIN FOR OPTIONS/ PRESS START  
VOLUME HIGH

PRESS AGAIN FOR OPTIONS/ PRESS START  
VOLUME OFF

**START**

**OFF**



## SETTING TURNTABLE ON/OFF

If the turntable is on:

Touch:	Display Shows:
 X2	<small>PRESS AGAIN FOR OPTIONS/ PRESS START</small> TURN TABLE ON
START	TT OFF

### NOTE

After cooking completed, turntable setting will return to ON automatically.

## SETTING WEIGHT LB/KG

Touch:	Display Shows:
 X3	<small>PRESS AGAIN FOR OPTIONS/ PRESS START</small> Lb / Kg
START	Kg

## SETTING LANGUAGE

If the language is English:

Touch:	Display Shows:
 X4	<small>PRESS AGAIN FOR OPTIONS/ PRESS START</small> LANGUAGE FRENCH
START	FRANCAIS

## SETTING FILTER

Touch:	Display Shows:
 X5	<small>PRESS AGAIN FOR OPTIONS/ PRESS START</small> ON
	<small>FILTER PRESS AGAIN FOR OPTIONS/ PRESS START</small> YES
	<small>FILTER PRESS AGAIN FOR OPTIONS/ PRESS START</small> OFF
	<small>FILTER PRESS AGAIN FOR OPTIONS/ PRESS START</small> YES
	<small>FILTER PRESS AGAIN FOR OPTIONS/ PRESS START</small> RESET

## SETTING FILTER

Touch:	Display Shows:
 X5	<small>FILTER PRESS AGAIN FOR OPTIONS/ PRESS START</small> YES
	<small>FILTER PRESS AGAIN FOR OPTIONS/ PRESS START</small> RESET
	<small>FILTER PRESS AGAIN FOR OPTIONS/ PRESS START</small> NO
START	NO

On yes	Filter indicator light on by default for recirculation. The filter indicator light will track the vent fan on time.
Off yes	Turn off the filter indicator light when vented to outside. The filter indicator light will not track the vent fan on time.
Rest yes	Reset Filter Indicator The filter indicator light on the display will track the vent fan on time. When it is time to change the charcoal filter the indicator light on the display will come on. Once the charcoal filter is changed, use reset yes to turn filter yes to turn filter indicator off and begin new time for charcoal filter replacement.
Rest no	Will not reset the time for filter indicator light.

## SETTING DEMO

If the language is English:

Touch:	Display Shows:
 X6	<small>PRESS AGAIN FOR OPTIONS/ PRESS START</small> DEMO OFF
START	ON

# 18 MAINTENANCE

## Troubleshooting

Check your problem by using the chart below and try the solutions for each problem. If the microwave oven still does not work properly, contact the nearest authorized service center.

TROUBLE	POSSIBLE CAUSE	POSSIBLE REMEDY
Oven will not start	<ul style="list-style-type: none"> <li>• Electrical cord for oven is not plugged in.</li> <li>• Door is open.</li> <li>• Wrong operation is set.</li> </ul>	<ul style="list-style-type: none"> <li>• Plug into the outlet.</li> <li>• Close the door and try again.</li> <li>• Check instructions.</li> </ul>
Arcing or sparking	<ul style="list-style-type: none"> <li>• Materials to be avoided in microwave oven were used.</li> <li>• The oven is operated when empty.</li> <li>• Spilled food remains in the cavity.</li> </ul>	<ul style="list-style-type: none"> <li>• Use microwave-safe cookware only.</li> <li>• Do not operate with oven empty.</li> <li>• Clean cavity with wet towel.</li> </ul>
Unevenly cooked foods	<ul style="list-style-type: none"> <li>• Materials to be avoided in microwave oven were used.</li> <li>• Food is not defrosted completely.</li> <li>• Cooking time, power level is not suitable.</li> <li>• Food is not turned or stirred.</li> </ul>	<ul style="list-style-type: none"> <li>• Use microwave-safe cookware only.</li> <li>• Completely defrost food.</li> <li>• Use correct cooking time, power level.</li> <li>• Turn or stir food.</li> </ul>
Overcooked foods	<ul style="list-style-type: none"> <li>• Cooking time, power level is not suitable.</li> </ul>	<ul style="list-style-type: none"> <li>• Use correct cooking time, power level.</li> </ul>
Undercooked foods	<ul style="list-style-type: none"> <li>• Materials to be avoided in microwave oven were used.</li> <li>• Food is not defrosted completely.</li> <li>• Oven ventilation ports are restricted.</li> <li>• Cooking time, power level is not suitable.</li> </ul>	<ul style="list-style-type: none"> <li>• Use microwave-safe cookware only.</li> <li>• Completely defrost food.</li> <li>• Check to see that oven ventilation ports are not restricted.</li> <li>• Use correct cooking time, power level.</li> </ul>
Improper defrosting	<ul style="list-style-type: none"> <li>• Materials to be avoided in microwave oven were used.</li> <li>• Cooking time, power level is not suitable.</li> <li>• Food is not turned or stirred.</li> </ul>	<ul style="list-style-type: none"> <li>• Use microwave-safe cookware only.</li> <li>• Use correct cooking time, power level.</li> <li>• Turn or stir food.</li> </ul>

Disconnect the power cord or leave the door open to deactivate the oven during cleaning. Disconnect the power cord before replacing filters and lights.

## EXTERIOR

The outside surface is precoated steel and plastic. Clean the outside with mild soap and water; rinse and dry with a soft cloth. Do not use any type of household or abrasive cleaner.

## DOOR

Wipe the window on both sides with a soft cloth to remove any spills or splatters. Metal parts will be easier to maintain if wiped frequently with a soft cloth. Avoid the use of spray and other harsh cleaners as they may stain, streak or dull the door surface.

## EASY CARE™ STAINLESS STEEL / SMUDGE \_PRO OF™ STAINLESS STEEL / BLACK STAINLESS STEEL(SOME MODELS)

Your microwave oven(some models) may have a Stainless Steel finish or coating. Clean the stainless with warm soapy water using a clean sponge or cloth. Rinse with clean water and dry with a soft clean cloth. DO NOT use ANY store bought cleaners like Stainless Steel cleaners or any other types of cleaners containing any abrasive, chlorides, chlorines or ammonia. It is recommended to use mild dish soap and water or a 50/50 solution of water and vinegar.

## TOUCH CONTROL PANEL

Care should be taken in cleaning the touch control panel. If the control panel becomes soiled, open the microwave oven door before cleaning. Wipe the panel with a cloth dampened slightly with water only. Dry with a soft cloth. Do not scrub or use any sort of chemical cleaners. Close door and touch STOP/CLEAR

## INTERIOR

Cleaning is easy because little heat is generated to the interior surfaces . To clean the interior surfaces, wipe with a soft cloth and warm water. DO NOT USE ABRASIVE OR HARSH CLEANERS OR SCOURING PADS. For heavier soil, use baking soda or a mild soap; rinse thoroughly with hot water. The round wire rack and shelf can be cleaned with hot soapy water, rinsed and dried.

## WAVEGUIDE COVER

The waveguide cover is located on the right side in the microwave oven cavity. It is made from mica so requires special care. Keep the waveguide cover clean to assure good microwave oven performance. Carefully wipe with a damp cloth any food splatters from the surface of the cover immediately after they occur. Built-up splashes may overheat and cause smoke or possibly catch fire. DO NOT REMOVE THE WAVEGUIDE COVER.

## ODOR REMOVAL

Occasionally, a cooking odor may remain in the microwave oven. To remove, combine 1 cup water, grated peel and juice of 1 lemon in a 2-cup glass measuring cup.

Boil for several minutes using 100% power. Allow to set in microwave oven until cool. Wipe interior with a soft cloth.

## TURNTABLE/TURNTABLE SUPPORT

The turntable and turntable support can be removed for easy cleaning. Wash them in mild, sudsy water; for stubborn stains use a mild cleanser and non-abrasive scouring sponge. They are also dishwasher-proof. Use upper wire rack of dishwasher. The turntable motor shaft is not sealed, so excess water or spills should be wiped up immediately.

# 20 CLEANING AND CARE

Disconnect the power cord or leave the door open to deactivate the oven during cleaning. Disconnect the power cord before replacing filters and lights.

## CLEANING THE EXHAUST FILTERS

The oven ventilation exhaust filters should be removed and cleaned often; generally at least once every month.

Vent exhaust filter part number 5304478913

To order parts call 800-599-7569

### CAUTION

To avoid risk of personal injury or property damage, do not operate oven hood without filters properly in place.

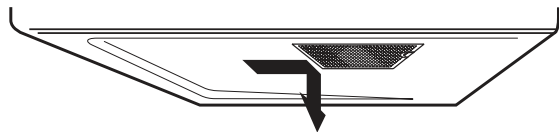
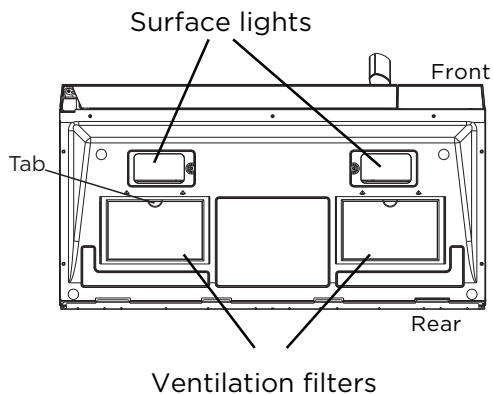

- To remove the exhaust ventilation filters, slide the filter to the rear. Then pull filter downward and push to the other side. The filter will drop out. Repeat for the 2nd filter.

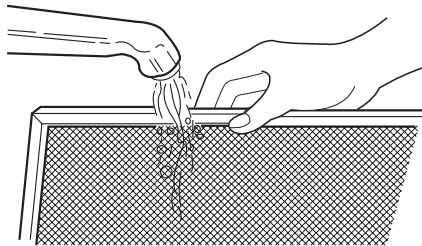

- Soak the ventilation filters in hot water using a mild detergent. Rinse well and shake to dry or wash in a dishwasher. Do not use ammonia. The aluminum on the filter will corrode and darken.

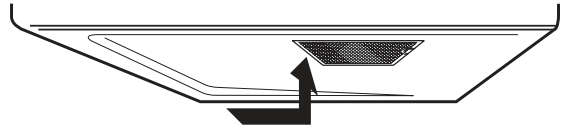

- To reinstall the exhaust ventilation filter, slide it into the side slot, then push up and toward oven to lock. Reinstall the 2nd filter using the same procedure.

Disconnect the power cord or leave the door open to deactivate the oven during cleaning. Disconnect the power cord before replacing filters and lights.

## CHARCOAL FILTER REPLACEMENT

Charcoal filter part number FRPAMRAF  
To order parts call 800-599-7569

Charcoal Filter when installed in your microwave oven, is used for nonvented, recirculated installation. When it is time to replace the charcoal filter, the FILTER light on display will turn on. If your microwave is vented to the outside, then you can turn off the filter light in the settings.

- Disconnect power to the microwave oven at the circuit breaker panel or by unplugging.
- Press the “Push” position on the cover.
- And then open the cover.

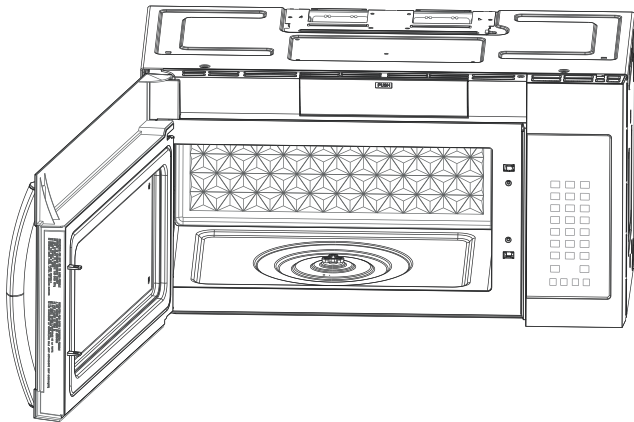

- Remove the charcoal filter by pushing the top of the filter inwards, then pull it forward out from the unit.

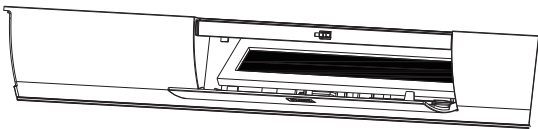
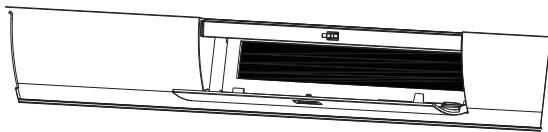

- Slide the top of the new charcoal filter into the top area of the filter cavity.

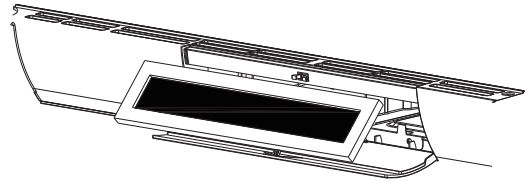

- Press the bottom of charcoal filter to place it into the correct position.

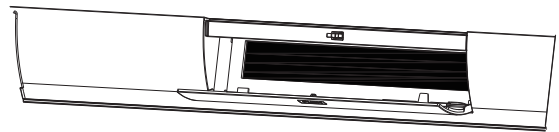

- Press the “Push” to close the cover.

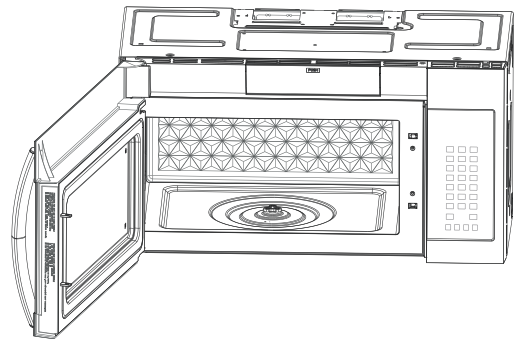

# 22 SERVICE CALL CHECK

Please check the following before calling for service:

Place one cup of water in a glass measuring cup in the microwave oven and close the door securely. Operate the microwave oven for one minute at HIGH 100%.

- |                                                                                            |                  |
|--------------------------------------------------------------------------------------------|------------------|
| A Does the microwave oven light come on?                                                   | YES ____ NO ____ |
| B Does the cooling fan work? (Put your hand at top above Display)                          | YES ____ NO ____ |
| C Does the turntable rotate? (It is normal for the turntable to turn in either direction.) | YES ____ NO ____ |
| D Is the water in the microwave oven warm?                                                 | YES ____ NO ____ |

**If “NO” is the answer to any of the above questions, please check electrical outlet, fuse and/or circuit breaker. If they are functioning properly, CONTACT YOUR NEAREST ELECTROLUX AUTHORIZED SER-VICER.**

**A microwave oven should never be serviced by a “do-it-yourself” repair person.**



## NOTE

1. If time appearing in the display is counting down very rapidly, check Demonstration Mode on page 19.
2. If the oven is set for more than 30 minutes at 90 or 100 percent power level, after the first 30 minutes the power level will automatically adjust itself to 80 percent power to avoid overcooking.

## SPECIFICATIONS

AC Line Voltage:	Single phase 120V, 60Hz, AC only
AC Power Required:	1500W 13.5 amps.
Output Power*:	1000 W
Frequency:	2450 MHz (Class B/Group2)**
Outside Dimensions (including handle):	29.88" (W) x 15.04" (D) x 16.41" (H)
Cavity Dimensions:	20.94" (W) x 9.57" (D) x 14.43" (H)
Microwave oven Capacity***:	1.9 Cu.Ft.
Cooking Uniformity:	Turntable
Weight:	Approx. (net) 55.2 lbs, (gross) 60.7 lbs
Work/Night Light:	2*1.2W LED, the part number is 5304499540.
Oven Light:	1*1.2W LED, the part number is 5304499540.

\* The International Electrotechnical Commission’s standardized method for measuring output wattage. method is widely recognized. test method

\*\* This is the classification of ISM (Industrial, Scientific and Medical) equipment described in the International Standard CISPR11.

\*\*\* Internal capacity is calculated by measuring maximum width, depth and height. Actual capacity for holding food is less. In compliance with standards set by:

FCC - Federal Communications Commission Authorized.

DHHS - Complies with Department of Health and Human Services (DHHS) rule, CFR, Title 21, Chapter I, Subchapter J.



- This symbol on the nameplate means the product is listed by Underwriters Laboratories, Inc.



- This symbol on the nameplate means the product is listed by Underwriters Laboratories, Inc. for use in USA or Canada.

Your appliance is covered by a one year limited warranty. For one year from your original date of purchase, Electrolux will pay all costs for repairing or replacing any parts of this appliance that prove to be defective in materials or workmanship when such appliance is installed, used and maintained in accordance with the provided instructions.

## Exclusions

This warranty does not cover the following:

1. Products with original serial numbers that have been removed, altered or cannot be readily determined.
2. Product that has been transferred from its original owner to another party or removed outside the USA or Canada.
3. Rust on the interior or exterior of the unit.
4. Products purchased "as-is" are not covered by this warranty.
5. Food loss due to any refrigerator or freezer failures.
6. Products used in a commercial setting.
7. Service calls which do not involve malfunction or defects in materials or workmanship, or for appliances not in ordinary household use or used other than in accordance with the provided instructions.
8. Service calls to correct the installation of your appliance or to instruct you how to use your appliance.
9. Expenses for making the appliance accessible for servicing, such as removal of trim, cupboards, shelves, etc., which are not a part of the appliance when it is shipped from the factory.
10. Service calls to repair or replace appliance light bulbs, air filters, water filters, other consumables, or knobs, handles, or other cosmetic parts.
11. Surcharges including, but not limited to, any after hour, weekend, or holiday service calls, tolls, ferry trip charges, or mileage expense for service calls to remote areas, including the state of Alaska.
12. Damages to the finish of appliance or home incurred during installation, including but not limited to floors, cabinets, walls, etc.
13. Damages caused by: services performed by unauthorized service companies; use of parts other than genuine Electrolux parts or parts obtained from persons other than authorized service companies; or external causes such as abuse, misuse, inadequate power supply, accidents, fires, or acts of God.

## DISCLAIMER OF IMPLIED WARRANTIES; LIMITATION OF REMEDIES

CUSTOMER'S SOLE AND EXCLUSIVE REMEDY UNDER THIS LIMITED WARRANTY SHALL BE PRODUCT REPAIR OR REPLACEMENT AS PROVIDED HEREIN. CLAIMS BASED ON IMPLIED WARRANTIES, INCLUDING WARRANTIES OF MERCHANTABILITY OR FITNESS FOR A PARTICULAR PURPOSE, ARE LIMITED TO ONE YEAR OR THE SHORTEST PERIOD ALLOWED BY LAW, BUT NOT LESS THAN ONE YEAR. ELECTROLUX SHALL NOT BE LIABLE FOR CONSEQUENTIAL OR INCIDENTAL DAMAGES SUCH AS PROPERTY DAMAGE AND INCIDENTAL EXPENSES RESULTING FROM ANY BREACH OF THIS WRITTEN LIMITED WARRANTY OR ANY IMPLIED WARRANTY. SOME STATES AND PROVINCES DO NOT ALLOW THE EXCLUSION OR LIMITATION OF INCIDENTAL OR CONSEQUENTIAL DAMAGES, OR LIMITATIONS ON THE DURATION OF IMPLIED WARRANTIES, SO THESE LIMITATIONS OR EXCLUSIONS MAY NOT APPLY TO YOU. THIS WRITTEN WARRANTY GIVES YOU SPECIFIC LEGAL RIGHTS. YOU MAY ALSO HAVE OTHER RIGHTS THAT VARY FROM STATE TO STATE.

## If You Need Service

Keep your receipt, delivery slip, or some other appropriate payment record to establish the warranty period should service be required. If service is performed, it is in your best interest to obtain and keep all receipts. Service under this warranty must be obtained by contacting Electrolux at the addresses or phone numbers below.

This warranty only applies in the USA and Canada. In the USA, your appliance is warranted by Electrolux Major Appliances North America, a division of Electrolux Home Products, Inc. In Canada, your appliance is warranted by Electrolux Canada Corp. Electrolux authorizes no person to change or add to any obligations under this warranty. Obligations for service and parts under this warranty must be performed by Electrolux or an authorized service company. Product features or specifications as described or illustrated are subject to change without notice.

## USA

1-800-374-4432

Electrolux Home Products,  
Inc., 10200 David Taylor  
Drive Charlotte, NC 28262



**Electrolux**

## Canada

1.800.265.8352

Electrolux Canada Corp.  
5855 Terry Fox Way  
Mississauga, Ontario, Canada  
L5V 3E4

Printed in China

# FRIGIDAIRE®

welcome *home*

Our home is your home. Visit us if you need help with any of these things:



owner support



accessories



service



registration

(See your registration card for more information.)

Frigidaire.com  
1-800-374-4432

Frigidaire.ca  
1-800-265-8352