



# Through-The-Wall Air Conditioner User Manual

Models:

ITAC08-LSA23

ITAC10-LSA23, ITAC10-LSB24

ITAC12-LSA23, ITAC12-LSB24

ITAC14-LRB24

[www.impecca.com](http://www.impecca.com)

Need Help?

Please call us, we're here to assist you!

Impecca Customer Service

1-866-

---

# INTRODUCTION

|  |    |
|--|----|
| IMPORTANT SAFETY INSTRUCTION .....         | 1  |
| ELECTRICAL REQUIREMENTS .....              | 2  |
| INTRODUCTION TO REFRIGERANTS R32 .....     | 3  |
| PACKING LIST .....                         | 5  |
| INSTALLATION & ASSEMBLY INSTRUCTIONS ..... | 6  |
| USING YOUR AIR CONDITIONER .....           | 9  |
| OPERATING YOUR AIR CONDITIONER .....       | 11 |
| CARE AND CLEANING .....                    | 12 |
| TROUBLESHOOTING .....                      | 13 |

---

## IMPORTANT SAFETY INSTRUCTIONS

Before installing and using your air conditioner, please read this owner's manual carefully. Store this manual in a safe place for future reference. Your safety and the safety of others is very important to us. Please pay attention to all safety messages outlined in this owner's manual.

**WARNING:** To reduce the risk of fire, electrical shock or injury when using your air conditioner, follow the following basic precautions:

- |   |  |
|---|--|
| <ul style="list-style-type: none"><li>• Plug into a grounded 3 prong outlet.</li><li>• Do not remove the ground prong.</li><li>• Do not use a plug adapter.</li></ul> | <ul style="list-style-type: none"><li>• Do not use an extension cord.</li><li>• Unplug the air conditioner before servicing</li><li>• Use two or more people to move and install the air conditioner</li></ul> |
|---|--|



This is a safety alert symbol.  
This symbol alerts you to potential hazards that can harm you or others or even cause death.  
All safety messages will directly follow the safety alert symbol and/or the words "DANGER" or "WARNING".

**▲ DANGER**

**▲ WARNING**

Failure to immediately follow these instructions may cause serious injury or even death.

All Safety messages alert you of potential hazards, how to reduce the chance of injury, and what can happen if instructions are not followed correctly.

# ELECTRICAL REQUIREMENTS

**⚠ WARNING**





**Electrical Shock Hazard**

Plug into a grounded 3 prong outlet.  
 Do not remove the ground prong.  
 Do not use an adapter  
 Do not use an extension cord.  
 Failure to follow these instructions can result in death, fire, or electrical shock

The electrical ratings for your air conditioner are listed on the model and serial number label located on the front left side of the unit (when facing the front).

Specific electrical requirements are listed in the chart below. Follow the requirements below for the type of plug on the power supply cord.

| Power Supply Cord   |   |   |
|---|---|---|
| 8K/10K/12K-115V<br>Cooling  | 8K/10K/12K/14K<br>Cooling & Heating   | 10K/12K/14K-230V<br>Cooling   |
|  |  |  |

## Recommended Ground Method

For your personal safety, this air conditioner must be grounded. This air conditioner is equipped with a 3 prong power supply cord with a grounded plug. To minimize the possibility of electrical shock, the cord must be plugged into a 3 prong outlet and grounded in accordance with all local codes and ordinances. If a 3 prong outlet is not available, it is the customer's responsibility to have a properly grounded 3 prong outlet installed by a qualified electrician.

### It is the customer's responsibility:

- To contact a qualified electrician
- To assure that the electrical installation is adequate and in conformance with the National Electrical Code, ANS/NFPA 70 - latest edition, and all local codes and ordinances.

### Copies of the standards listed may be obtained from:

National Fire Protection Association  
 One Batterymarch Park  
 Quincy, Massachusetts 02269

## LCDI Power Cord and Plug

This air conditioner is equipped with an LCDI (Leakage Current Detection and Interruption) power cord that is required by UL. This power supply cord contains state-of-the-art electronics that sense leakage current. If the cord is damaged and leakage occurs, power will be disconnected from the unit.

The test and reset buttons on the LCDI Plug are used to check if the plug is functioning properly. To test the plug:

1. Plug power cord into a grounded 3 prong outlet
2. Press RESET (on some units a green light will turn on).
3. Press the TEST Button, the circuit should trip and cut all power to the air conditioner (on some units a green light may turn off).
4. Press the RESET button for use. You will hear a click and the A/C is ready for use.

### NOTES:

- The RESET button must be engaged for proper use.
- The power supply cord must be replaced if it fails to trip when the TEST button is pressed and the unit fails to reset.
- Do not use the power supply cord as an ON/OFF switch. The power supply cord is designed as a protection device.
- A damaged power supply cord must be replaced with a new power supply cord.
- The power supply cord contains new user serviceable parts. Opening the tamper-resistant case voids all warranty and performance claims.

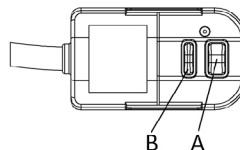

A. Reset button  
 B. Test button

NOTE: Your units power cord and plug may differ from the one shown.

## INTRODUCTION TO REFRIGERANTS R32

The refrigerants used for air conditioners are environmentally friendly hydrocarbons R32. This kind of erant is combustible and odorless. Moreover, it can burn and explode under certain condition. However, there will be no risk of burning and explosion if you comply with the following table to install your air conditioner in a room with an appropriate area and use it correctly.

Compared with ordinary refrigerants, Refrigerant R32 is environmentally friendly and do not destroy the ozone sphere and that its value of greenhouse effect is also very low.

### **Warning**

- Please read the manual before installation, using, maintenance.
- Do not use means to accelerate the defrosting process or to clean, other than those recommended by the manufacturer.
- Do not pierce or burn the appliance.
- The appliance shall be stored in a room without continuously operating sources (for example: open flames, an operating ignition gas appliance or an operating electric heater.) Please contact the nearest after-sale service center when maintenance is necessary.
- At the time of maintenance, the maintenance personnel must strictly comply with the Operation Manual provided by the corresponding manufacturer and any nonprofessional is prohibited to maintain the air conditioner.
- The handling, installation, storage, servicing and disposal must comply with the provisions of gas-related national laws and regulations, and also national wiring regulation.
- It is necessary to clear away the refrigerant in the system when maintaining or scrapping an air conditioner. Be aware that refrigerants may not contain an odour.

This appliance is not intended for use by persons (including children) with reduced physical, sensory or mental capabilities, or supervision or instruction concerning use of the appliance by a person responsible for their safety. Children should be supervised to ensure that they do not play with the appliance.

Unit operation limits: Outdoor side 61~110, 80%RH, indoor side 61~90, 80%RH.



## Introduction to Refrigerants R32

- Before installing the appliance, you must read the manual carefully to get the safety information and notes.
- When filling the combustible refrigerant, any of your rude operations may cause serious injury or injuries to human body or bodies and object or objects.
- A leak test must be done after the installation is completed.
- It is a must to do the safety inspection before maintaining or repairing an air conditioner using combustible refrigerant in order to ensure that the fire risk is reduced to minimum.
- It is necessary to operate the machine under a controlled procedure in order to ensure that any risk arising from the combustible gas or vapor during the operation is reduced to minimum.
- Requirements for the total weight of filled refrigerant and the area of a room to be equipped with an air conditioner.

## 1. Site Safety



Open Flames Prohibited

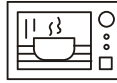

Open Flames Prohibited



Ventilation Necessary



Mind Static Electricity



Must Wear Protective Clothing  
and anti-static gloves



Don't use mobile phone

## 3. Installation Safety



- Refrigerant Leak Detector
- Appropriate Installation Location
- The left picture is the schematic diagram of a refrigerant leak detector

### Please note:









- The installation site should be in a well-ventilated condition.
- The sites for installing and maintaining an air conditioner using Refrigerant R32 should be free from open fire or welding, smoking, drying oven or any other heat source higher than 548 C/1018F which easily produces open fire.
- When installing an air conditioner, it is necessary to take appropriate anti-static measures such as wear anti-static clothing and/or gloves.
- It is necessary to choose the site convenient for installation or maintenance wherein the air inlets and outlets of the indoor and outdoor units should be not surrounded by obstacles or close to any heat source or combustible and/or explosive environment.
- If the indoor unit suffers refrigerant leak during the installation, all the personnel should go out till the refrigerant leaks completely for 15 minutes. If the product is damaged, it is a must to carry such damaged product back to the maintenance station and it is prohibited to weld the refrigerant pipe or conduct other operations on the user's site.
- It is necessary to choose the place where the inlet and outlet air of the indoor unit is even.
- It is necessary to avoid the places where there are other electrical products, power switch plugs and sockets, kitchen cabinet, bed, sofa and other valuables right under the lines on two sides of the indoor unit, and also prevent mechanical damage from occurring.

## Using Your Air Conditioner

### Normal Operating Sounds

- You may hear a pinging noise caused by water hitting the condenser, on rainy days, or when the humidity is high. This design feature helps remove moisture and improve efficiency.
- You may hear the thermostat click when the compressor cycles on and off.
- Water will collect in the base pan during rain or days of high humidity. The water may overflow and drip from the outside part of the unit. The fan may run even when the compressor is not on.

## PACKING LIST

| IMAGE   | PAPT                             | QUANTITY |
|---|----------------------------------|----------|
|                                | Through-The-Wall Air Conditioner | 1        |
|                                | Remote Control                   | 1        |
|                                | Trim Frame 1 (Left&Right legs)   | 2        |
|                                | Trim Frame 2 (Top&Bottom legs)   | 2        |
|                                | Grille Aluminum                  | 1        |
|                                | Rear plastic net                 | 1        |
|  | 1/2" Long Hex-head Screw         | 4        |
|                                | Grounding wire with tooth washer | 1        |
|                                | Battery                          | 2        |
| Dimension   | PAPT                             | QUANTITY |
| 1"x3/4"x14"   | Seal sponge                      | 2        |
| 1"x3/8"x14"   | Seal sponge                      | 2        |
| 1"x3/8"x25"   | Seal sponge                      | 3        |
| 1"x1 1/2"x25"   | Seal sponge                      | 3        |
| 1"x1 1/2"x14"   | Seal sponge                      | 2        |
| 1"x1 1/2"x84"   | Seal sponge                      | 1        |
| 3 3/4"x1 1/2"x4"  | Seal cotton                      | 4        |
| 3/4"x1 1/2"x17"   | Seal cotton                      | 2        |

# INSTALLATION & ASSEMBLY INSTRUCTIONS

## Condition1: Install the back grille to the Wall-sleeve (Prior Suggestion)

1, Identify the wall-sleeve brand for your preparing, from the below chart.

| Type               | Wall-sleeve Dimensions |         |                |
|--------------------|------------------------|---------|----------------|
|                    | Height                 | Width   | Depth          |
| Standard Dimension | 15 1/4"                | 25 1/2" | 16" or 17 1/2" |

**NOTE :**

- a, All wall sleeves used to mount the new air conditioner must be in sound structural condition and have a rear grille that securely attached to the sleeve, or rear flange that serves as a stop for the air conditioner.
- b, If you choose other wall-sleeve, be sure the dimension is suitable for the product.
- c, The wall-sleeve you selected must be installed fasten to the wall with screw.
- d, When do the performance testing, we suggest cancel the wall-sleeve, and install the new back grille with the new unit, to avoid the wrong installation worse affect.

2, Prepare the Wall-sleeve before installation the unit.

(1) Remove old Air Conditioner from wall sleeve and prepare as followings:

- a, Clean interior (Re-stick the seals if necessary).
- b, Check the wall sleeve be securely fastened in wall before installing. Add more nails or screws if needed.
- c, Repair painted surface if needed.

(2) Remove the back grille.

**Important:** The old intake grille must be removed and replaced by the dual intake grille included with the TTW unit.  
**Warning:** When removing the grille, protect from falling by securing with a leash. Fasten by strapping looped through the grille and secured with a knot. Holding the grille by the leash with one hand the retaining screws can be removed and the grille can be brought inside through the front of the sleeve.

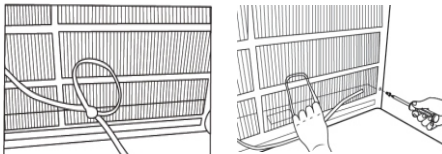

(3) Check the grounding wire hole.

- a, If it does not exist, drill a 3/16" pilot hole through the left hand side of the sleeve, in a clear area about 3 inches max deep from the front edge as below.
- b, Fasten the grounding wire with screw to the drilled hole, and pull the loose end of the ground wire out of the front of the sleeve and bend it away from the opening. This will be attached to the air conditioner once installed.

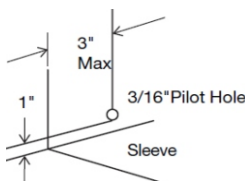

3, Replace the back grille.

- a, Remove the old grille, and install with the dual intake coming with the TTW unit. Take attention the remark on the new back grille (if it appears).
- b, Put the [OUTSIDE] remark toward to the back side of wall-sleeve, and let the arrow remark toward upside.
- c, Be sure that, from the back side of the wall-sleeve, the seven inlet opening should be at left, and the eight inlet opening should be at right.
- d, Place the grille included with your new air conditioner towards the inside rear of the sleeve. Fasten together with the wall-sleeve by four screws.

**New Dual Intake Grille**

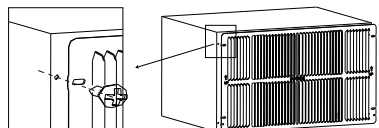
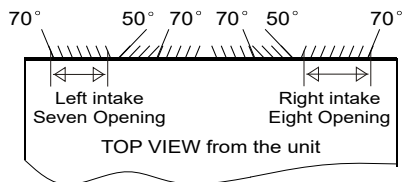
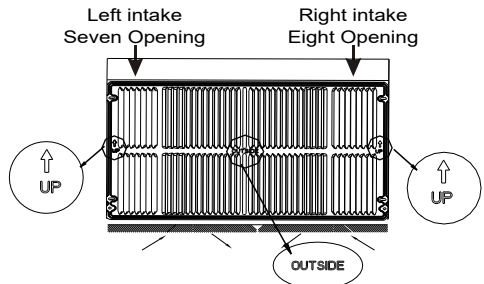



#### 4, Install the Seal.

(1) Stick 1"x4/5"x13 4/5" sponges to the condenser side plate, for both left and right at the back side of TTW unit.

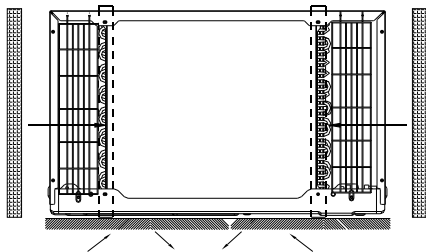

(2) Seal the Wall-sleeve inside.

- a, Seal the internal back side of wall-sleeve by sponges.
- b, Seal and stick the top and bottom inside back edge by two 1"x1 1/2"x25" long and thick sponges.
- c, Seal and stick the left and right inside back edge by two 1"x1 1/2"x13 4/5" shorter and thick sponges.

**IMPORTANT:** Be sure that, these seal sponges will not block the back grille inlet opening. If they effect the air-inlet or outlet, cut them to the suitable dimension or thickness.

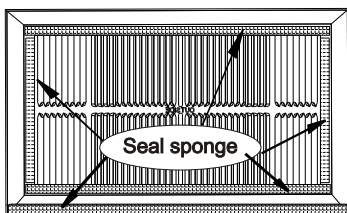

#### 5, Set the tilt angle backward.

(1) Cut two suitable dimension of pearl seal cottons, and stick to the front bottom of wall-sleeve.

(2) Be sure that, there will be a 3° tilt angle backward of the sleeve and unit, when slide in the TTW unit.

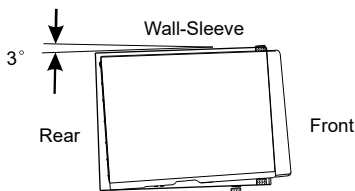
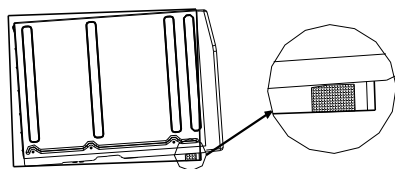

#### 6, Install the grounding wire.

- a, Install screw end of ground wire into inside of sleeve according to preparation instruction.
- b, Remove the second screw from left side of unit, and remove the screw plastic washer.
- c, Screw the other end of the ground wire into the unit. Make sure the toothed washer is against the cabinet.



7, Gently slide the TTW unit into wall-sleeve. Be sure that, the unit should be a 3° tilt angle backward. If necessary, add some pearl cotton to the unit bottom.

### Condition2: Install the back grille to the TTW

In case where the dual intake grille cannot be mounted directly to the sleeve. It is desirable to attach the grille to the back of the TTW unit to the hole pre-drilled in the unit.

- 1, Prepare the wall-sleeve followed the Condition 1 part.
- 2, Stick 1"x4/5"x13 4/5" sponges to the condenser side plate, for both left and right at the back side of TTW unit.

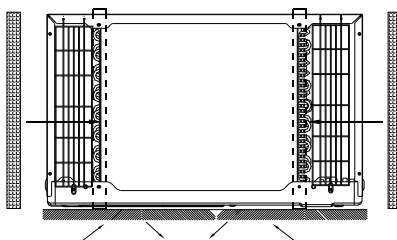

3, Install the back grille to the back side of the TTW unit to the hole pre-drilled. Take attention the remark on back grille including in the new unit, if it appears.

- a, Put the [OUTSIDE] remark toward to outside, and let the arrow remark toward upside.
- b, Place the new grille to the TTW unit. Fasten together with the wall-sleeve by four screws.

c. Be sure that, from the back side of the TTW, the seven inlet opening should be at left, and the eight inlet opening should be at right.

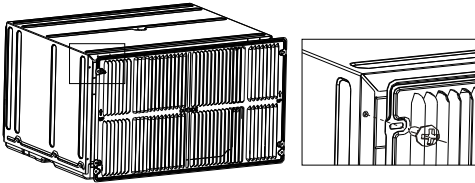
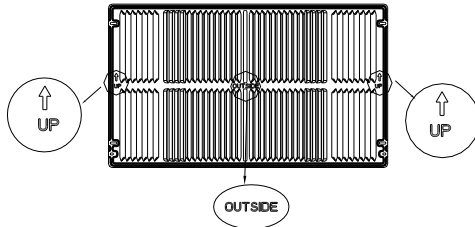

4. Seal the Wall-sleeve inside. Seal the internal back side of wall-sleeve followed condition 1 part.

**Important:** Be sure that, all the seal sponges will not block the back grille inlet opening. If they effect the air-inlet or outlet, cut them to the suitable dimension or thickness.

5. Set the tilt angle backward followed the Condition 1 part.

(1) Cut two suitable dimension of pearl seal cottons, and stick to the front bottom of wall-sleeve.

(2) Be sure that, there will be a 3° tilt angle backward of the sleeve and unit, when slide in the TTW unit.

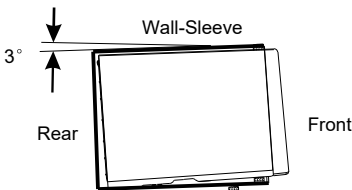
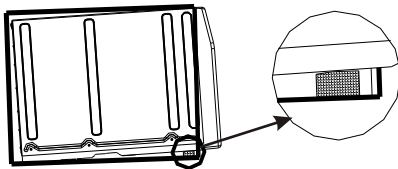

6. Gently slide the TTW unit into wall-sleeve. Be sure that, the sleeve and unit should be a 3° tilt angle backward. If necessary, add some pearl cotton to the unit bottom.

### Trim Kit Installation Instructions

1. Install the 1"x1 1/2" x84" long stuffer seal between the wall sleeve and the unit. A flat-bladed screwdriver or putty knife is needed.
2. Assemble the trim frame by inserting the top and bottom pieces into side pieces and snapping into place.
3. Pull the cord through the trim frame and slide the trim over the unit until flush with the wall.

**Important:** Be sure that, the gap between wall-sleeve and unit, is well sealed by sponge all around. If necessary, add some extra sponge and adhesive tap to fill it.

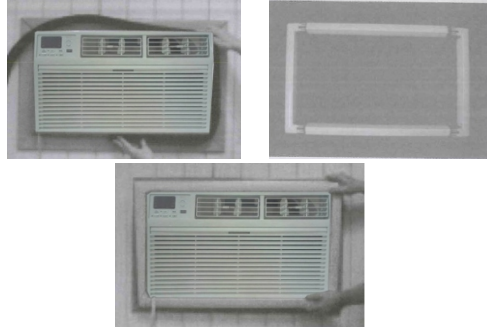

### Testing Installation Instructions

1. When do the performance testing, we suggest cancel the wall-sleeve, and install the new back grille to the new unit, to avoid the wrong installation worse affect.
2. Install the back grille to the unit following Condition 2 part. Use sponge and adhesive tap to fill all the gap around between the grille and TTW unit. Cut the sponge to suitable dimension, be sure that, they will not effect the air-inlet or outlet.
3. Set the tilt angle, let the sleeve and unit be a 3° tilt angle backward to outdoor side.
4. Set the indoor air-outlet louver at the center position, both horizontal and vertical direction.
5. Add enough water to the outside chassis to let the heating exchange of condenser be the best condition.
6. Check whether the back grille opening angle is well or not, if necessary, repair or replace it.

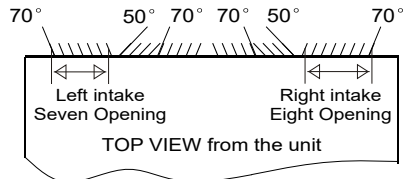

**Energy saving suggestion:** In order to reach the maximum energy saving and comfortable, it is necessary to use an appropriately sized cover to provide additional insulation and air sealing when the unit is not in use during the off-using-season.

## USING YOUR AIR CONDITIONER

### Electronic Control Panel & Remote Control

NOTE: This display always shows the room temperature in Fan Mode except when setting the Timer.

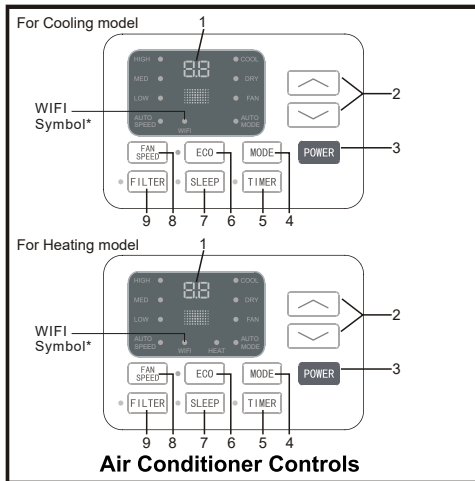

**Air Conditioner Controls**

NOTE: \* means only available for WIFI modes, For more information, please see the WIFI manual.

### Normal Operating Sounds

- You may hear a pinging noise caused by water hitting the condenser on rainy days, or when the humidity is high. This design feature helps remove moisture and improve efficiency.
- You may hear the thermostat click when the compressor cycles on and off.
- Water will collect in the base pan during rain or days of high humidity. The water may overflow and drip from the outside part of the unit.
- The fan may run even when the compressor is not on.

- Digital Display:** Without timer setting, the set temperature will be displayed. Time will be displayed under the timer setting.
- + and - Button:** Use these buttons on the control panel and remote to increase or decrease the Set Temperature or Timer. Long press the down button 3s can override the dr mode. Temperature range: 61°F~88°F or 16°C~31°C.
- Power Button:** Turn the air conditioner on and off.
- Mode Button:** Press the mode button to cycle through the various modes: Cool, Dry, Fan and Auto, or Heat.

**Cool Mode:** The cooling function allows the air conditioner to cool the room and at the same time reduces air humidity. Press the MODE button to activate the cooling function. To optimize the function of the air conditioner, adjust the temperature and the speed by pressing the button indicated.

**Dry Mode:** This function reduces the humidity of the air to make the room more comfortable. Press MODE button to set the DRY mode. An automatic function of alternating cooling cycles and air fan is activated.

**Fan Mode:** The conditioner works in only ventilation. Press MODE button to set the FAN mode. With pressing the FAN SPEED button the speed changes in the following sequence: Hi, Med and Lo in FAN mode.

**Auto Mode:** In AUTO mode the unit automatically chooses the fan speed and the mode of operation (COOL, HEAT, or FAN). In this mode the temperature are set automatically according to the room temperature (tested by the temperature sensor which is incorporated in the indoor unit.).

**Heat Mode:** The heating function allows the air conditioner to heat the room. Press the MODE button to activate the heating function. To optimize the function of the air conditioner, adjust the temperature and the speed by pressing the button indicated.

- Timer Button:** Use these buttons on the control panel and remote to set the Timer.

**Timer Off:** The timed stop is programmed by pressing TIMER button. Set the rest time by pressing the button “+” or “-” until the rest time displayed is to your liking then press the TIMER button again.

**Timer On:** When the unit is off, press TIMER button at the first time, set the temperature with pressing the button “+” or “-”. Press TIMER button at the second time, set the rest time with pressing the button “+” or “-”. Press TIMER button at the third time, confirm the setting, then the rest time to next automatical switching-on could be read on the display of the machine.

**Note:** It can be set to automatically turn off or on in 0.5-24 hours. Each press of the “+” “-” buttons will increase or decrease the timer. The Timer can be set in 0.5 hours increment below 10 hours and 1 hour increment for 10 hours or above. The SET light will turn on while setting. To cancel the set function, press the TIMER button again.

## USING YOUR AIR CONDITIONER

### Electronic Control Panel & Remote Control

6. **ECO Button:** When the unit is in ECO mode, the light will turn on. In ECO mode, the unit will turn-off once the room is cooled to the user set temperature. The unit will turn back on when the room temperature rises above the user set temperature. Before the compressor starts, the fan motor will run for a while, then it will stop for awhile, It will repeat to provide a much more comfortable feeling and save energy.

7. **Sleep Button:** Press the SLEEP button, all the display lights will turn off after a while, but the Sleep Light is always on. In SLEEP mode, the airconditioner will automatically adjust the temperature and fan speed to make the room more comfortable during the night. The set temperature will automatically raise or decrease based on the room temperature and the duration of sleep.

8. **Fan Speed Button:** Press the FAN SPEED button to choose the fan speed options. You can choose Hi, Med, Lo or auto speed in COOL mode and choose Hi, Med, Lo in FAN mode.

9. **Filter Button:** When the Filter Check light is off, it isn't necessary to press the Filter Check button. When the Filter Check light is on, you can turn off the light by pressing the Filter Check button. After the fan motor works for 500 total hours, the Filter Check light will turn on to remind the user to clean the filter.

10. **Directional Louvers:** To direct the airflow, use the horizontal wheel to control the horizontal direction and the air deflector to control the vertical direction.

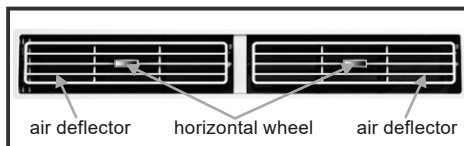

# OPERATING YOUR AIR CONDITIONER

## REMOTE CONTROL

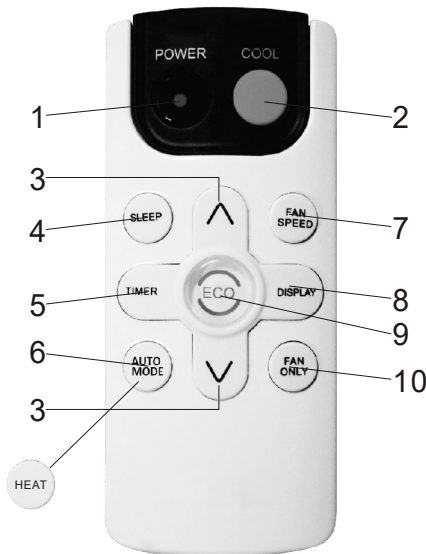

\*For mark 6 button, it is AUTO MODE for cooling only, and it is HEAT for heating model.

1. Power: Turn the air conditioner on and off.
2. Cool: Press the COOL button to COOL mode.
3.  $\wedge$  and  $\vee$ : Use these buttons on the control panel and remote to increase or decrease the Set Temperature or Timer. Temperature range: 61°F~88°F or 16°C~31°C.
4. Sleep: Press the SLEEP button, all the display lights will turn off after a while, but the Sleep Light is always on. In SLEEP mode, the air conditioner will automatically adjust the temperature and fan speed to make the room more comfortable during the night. The set temperature will automatically raise or decrease based on the room temperature and the duration of sleep.
5. Timer: Use these buttons on the control panel and remote to set the Timer.  
**Timer Off:** The timed stop is programmed by pressing TIMER button. Set the rest time by pressing the button “ $\wedge$ ” or “ $\vee$ ” until the rest time displayed is to your demand then press TIMER button again.  
**Timer On:** When the unit is off, press TIMER button at the first time, set the temperature with pressing the button “ $\wedge$ ” or “ $\vee$ ”. Press TIMER button at the second time, set the rest time with pressing the button “ $\wedge$ ” or “ $\vee$ ”. Press TIMER button at the third time, confirm the setting, then the rest time to next automatical switching-on could be read on the display of the machine.  
**Note:** It can be set to automatically turn off or on in 0.5-24 hours. Each press of the “ $\wedge$ ” “ $\vee$ ” buttons will increase or decrease the timer. The Timer can be set in 0.5 hours increment below 10 hours and 1 hour increment for 10 hours or above. The SET light will turn on while setting. To cancel the setted function, press the TIMER button again.
6. a. Auto Mode: In AUTO mode the unit automatically chooses the fan speed and the mode of operation (COOL, or FAN). In this mode the fan speed and the temperature are set automatically according to the room temperature (tested by the temperature sensor which is incorporated in the indoor unit.). It is for cooling only model.  
b. HEAT: Press the HEAT button to HEAT mode. It is for heating model.
7. Fan Speed: Press the FAN SPEED button to choose the fan speed options. You can choose Hi, Med, Lo or auto speed in COOL mode and choose Hi, Med, Lo in FAN mode.
8. Display: To press the DISPLAY button, it can switch off/on all lights or LED display.
9. Eco: When the unit is in ECO mode, the light will turn on. In ECO mode, the unit will turn-off once the room is cooled to the user set temperature. The fan will also be off at this point. The unit will turn back on when the room temperature rises above the user set temperature. Before the compressor starts, the fan motor will run for 20s, then it will stop for 10minutes -and will repeat to provide a much more comfortable-feeling and save energy.
10. Fan Only: Press the Fan Only button to FAN ONLY mode.

Battery Size: AAA - NOTE: Do not mix old and new batteries or different types of AAA batteries.

## CARE AND CLEANING

Clean your air conditioner to keep it looking new and to minimize dust build up.

### Air Filter Cleaning

The air filter should be checked at least once every month to see if it needs cleaning. Trapped particles and dust can build up in the filter and may decrease airflow as well as cause the cooling coils to accumulate frost. To clean the air filter:

1. Remove the filter by pulling down on the indent of the filter door on the front of the unit. (See FIG.21)
2. Wash the filter using liquid dish soap and warm water. Rinse the filter thoroughly. Gently shake the filter to remove excess water.
3. Let the filter dry completely before placing it into the air conditioner.
4. If you do not wish to wash the filter, you may vacuum the filter to remove the dust and other particles.



FIG.21

### Wear and Tear

To minimize wear and tear on the air conditioner, always wait at least 3 minutes before changing modes. This will help prevent the compressor from overheating and the circuit breaker from tripping.

## Cabinet Cleaning

To clean the air conditioner cabinet:

- Unplug the air conditioner to prevent shock or a fire hazard. The cabinet and front panel of the air conditioner may be dusted with an oil-free cloth or washed with a cloth dampened in a solution of warm water and mild liquid soap. Rinse thoroughly with a damp cloth and wipe dry.
- Never use harsh cleaners, wax or polish on the cabinet front.
- Be sure to wring excess water from the cloth before wiping around the controls. Excess water in or around the controls may cause damage to the air conditioner.

## TROUBLESHOOTING

| PROBLEM   | POSSIBLE CAUSES   | SOLUTIONS   |
|---|---|---|
| <b>The Air Conditioner will not start</b>             | The air conditioner is unplugged  | <ul style="list-style-type: none"> <li>Make sure the air conditioner is plugged completely into the outlet</li> </ul>   |
|   | The fuse is blown/circuit breaker is tripped                                | <ul style="list-style-type: none"> <li>Check the house fuse/circuit breaker box and replace the fuse or reset the breaker</li> </ul>  |
|   | Power Failure   | <ul style="list-style-type: none"> <li>The unit will automatically re-start when power is restored.</li> <li>There is a protective time delay (approx. 3 minutes) to prevent tripping of the compressor overload. For this reason, the unit may not start normal cooling for 3 minutes after it is turned back on.</li> </ul> |
|   | The current interrupter device is tripped                                   | <ul style="list-style-type: none"> <li>Press the RESET button located on the power cord plug</li> <li>If the RESET button will not stay engaged, discontinue use of the air conditioner and contact a qualified service technician</li> </ul>   |
| <b>The Air Conditioner does not cool as it should</b> | Airflow is restricted   | <ul style="list-style-type: none"> <li>Make sure there are no curtains, blinds, or furniture blocking the front of the air conditioner</li> </ul>   |
|   | The temperature control may not be set correctly.                           | <ul style="list-style-type: none"> <li>Lower the set thermostat temperature</li> </ul>  |
|   | The air filter is dirty   | <ul style="list-style-type: none"> <li>Clean the filter. See the Cleaning and Care Section of the manual.</li> </ul>  |
|   | The room may be too warm  | <ul style="list-style-type: none"> <li>Please allow time for the room to cool down after turning on the air conditioner</li> </ul>  |
|   | Cold air is escaping  | <ul style="list-style-type: none"> <li>Check for open furnace registers and cold air returns</li> </ul>   |
|   | The cooling coils are frozen  | <ul style="list-style-type: none"> <li>See "Air Conditioner Freezing Up" below</li> </ul>   |
| <b>The Air Conditioner is freezing up</b>             | Ice blocks the air flow and stops the air conditioner from cooling the room | <ul style="list-style-type: none"> <li>Set the MODE to HIGH FAN or HIGH COOL and set the thermostat to a higher temperature</li> </ul>  |
| <b>The Remote Control is not working</b>              | The batteries are inserted incorrectly                                      | <ul style="list-style-type: none"> <li>Check the position of the batteries</li> </ul>   |
|   | The batteries may be dead   | <ul style="list-style-type: none"> <li>Replace the batteries</li> </ul>   |

## TROUBLESHOOTING (CONT.)

| PROBLEM                                    | POSSIBLE CAUSES  | SOLUTIONS  |
|--|--|--|
| <b>Water is dripping outside</b>           | Hot and Humid weather  | <ul style="list-style-type: none"> <li>• This is normal</li> </ul>   |
| <b>Water is dripping inside the room</b>   | The air conditioner is not correctly tilted outside  | <ul style="list-style-type: none"> <li>• For proper water drainage, make sure the air conditioner is slightly tilted downward from the front of the unit to the rear</li> </ul>                |
| <b>Water collects in the base pan</b>      | Moisture removed from the air is draining into the base pan  | <ul style="list-style-type: none"> <li>• This is normal for a short period in areas with low humidity and normal for a longer period in areas with high humidity</li> </ul>                    |
| <b>Digital Display reads “E1”, “E2”</b>    | A sensor has failed  | <ul style="list-style-type: none"> <li>• Contact customer service</li> </ul>   |
| <b>Display dr and unit without control</b> | The air conditioner is under demand response, only turn ON/OFF can be activated, and the set temperature may raise, and the compressor may stop. | <ul style="list-style-type: none"> <li>• It is the demand response condition, you can wait for the Delay time or override it by long press down button for 3s on the control panel.</li> </ul> |



# COSTUMER SUPPORT

---

Before contacting customer support, please see the troubleshooting guide above.

Upon unpacking your air conditioner, please be sure to write down the model and serial number of your unit. This will be needed should your unit require servicing in the future. The number is found on a barcode on the right side of the air conditioner and on a similar barcode on the outside of the box the unit came in.

We recommend holding onto the box, but as many people do throw it away, and the air conditioner itself gets installed in a window, it can be difficult to access this serial number later.

Model number: \_\_\_\_\_ (One of the numbers mentioned on the cover of this manual). Your exact number is found on your box or on the rating label sticker on the right side of the unit.

Serial number (11 digits) \_\_\_\_\_

Please keep this manual for your records!

Visit our website to contact us, find answers to Frequently Asked Questions, and for other resources which may include an updated version of this user's guide.

 **WWW.IMPECCA.COM**

If you wish to contact us by phone, please be sure to have your model number and serial number ready and call us between 9:00am and 5:00pm ET, at +1 866-954-4440.

Keep tabs on Impecca's newest innovations & enter contests via our social network feeds:

 [www.facebook.com/Impecca/](http://www.facebook.com/Impecca/)

 [www.instagram.com/impecca/](http://www.instagram.com/impecca/)

 [@impeccausa](https://twitter.com/impeccausa)

# ONE-YEAR LIMITED APPLIANCE WARRANTY (US)

Impecca™ warrants this product against defects in material and workmanship to the original purchaser as specified below.

**PARTS AND LABOR– if the product is determined to have a manufacturing defect, within a period of one year from the date of the original purchase, Impecca™, at its own discretion, will repair or replace the product parts at no charge to you in the U.S.A.**

To obtain warranty service by an authorized Impecca™ service center, please email us at: [service@impecca.com](mailto:service@impecca.com) to obtain a Repair and Maintenance Authorization (RMA) number and received instructions on how the repair and/or replacement procedure will take place.

**Any glass materials included with the appliance will be covered for a period of 60 days from purchase.**

Impecca™ specifically excludes from this warranty any non-electric/mechanical attachments, accessories and disposable parts including but not limited to outside case, connecting cables, batteries and AC adapters. Impecca™ reserves the right to repair or replace defective products with the same, equivalent or newer models.

We reserve the right to either repair or replace product at our discretion. Replacement may be either new or refurbished and while every endeavor will be made to ensure it is the same model, if not possible it will be equal or higher specification.

Normal “Wear and Tear” is not covered by this warranty. Further, Impecca™ hereby reserves the right to determine “Wear and Tear” on any and all products. Tampering or opening the product casing or shell will void this warranty in its entirety.

Exclusions: This warranty does not cover the following:

1. Any product that has a defaced or covered serial number.
2. Products that have been transferred to a second owner.
3. Rust on the interior or exterior of the unit.
4. Products listed as “As-Is” or “Refurbished.”
5. Food loss due to any product failure.
6. Window air conditioners installed in a wall.
7. The product if used in a commercial setting.
8. Service calls that do not involve product malfunction.
9. Service calls for a product ruined by not following the provided instructions.
10. Service calls to correct improper installation.
11. Costs associated with making the product accessible for servicing (including but not limited to removal of

trim/molding/cabinetry, etc.)

12. Service calls to replace any consumables such as light bulbs, filters, etc.
13. Surcharges that may apply to service calls on weekends, nights, holidays. Damages to the finish of appliance or household furnishings due to installation of appliance.
14. Damages caused by any of the following: Acts of God; fires; misuse; accidents; incorrect power supply; service performed by unauthorized persons; use of non-genuine Impecca parts, etc.

ALL IMPLIED WARRANTIES, INCLUDING IMPLIED WARRANTIES OF MERCHANTABILITY AND FITNESS FOR A PARTICULAR PURPOSE ARE LIMITED IN DURATION TO 1 YEAR FROM THE DATE OF THE ORIGINAL RETAIL PURCHASE OF THIS PRODUCT.

THESE WARRANTIES AND REMEDIES ARE THE SOLE AND EXCLUSIVE WARRANTIES AND REMEDIES IN CONNECTION WITH THE SALE AND USE OF THE PRODUCT. NO OTHER WARRANTIES, ORAL OR WRITTEN, EXPRESSED OR IMPLIED, ARE GIVEN.

IMPECCA™ IS NOT RESPONSIBLE OR LIABLE FOR ANY DAMAGE, WHETHER SPECIAL, INCIDENTAL, CONSEQUENTIAL, DIRECT OR OTHERWISE, OR WHETHER KNOWN OR SHOULD HAVE BEEN KNOWN TO IMPECCA™, INCLUDING LOST PROFITS, GOODWILL, AND PROPERTY AND PERSONAL INJURY RESULTING FROM ANY BREACH OF WARRANTY, THE INABILITY TO USE THE PRODUCT OR UNDER ANY LEGAL THEORY IN CONTRACT OR TORT. IMPECCA LIABILITY IS LIMITED TO THE ACTUAL PURCHASE PRICE PAID TO THE RETAIL SELLER OF THE DEFECTIVE PRODUCT.

No Impecca™ dealer, agent or employee is authorized to make any modification, extension, change or amendment to this warranty without the written consent and authorization from Impecca™.

Some states do not allow the exclusion or limitation of implied warranties or liability for incidental or consequential damages, or do not allow a limitation on how long an implied warranty lasts, so the above limitations or exclusions may not apply to you. This warranty gives you specific legal rights, and you have other rights, which vary from state to state.

*Note: Our Warranty center services only to Continental U.S.A.*