

SHARP®

KC-860U

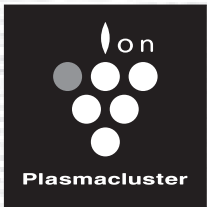

Device of this mark is a trademark of Sharp Corporation. "Plasmacluster" and "Device of a cluster of grapes" are registered trademarks of Sharp Corporation in Japan, USA and elsewhere.

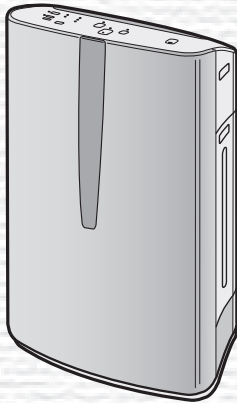

This product earned the ENERGY STAR by meeting strict energy efficiency guidelines set by the US EPA. US EPA does not endorse any manufacturer claims of healthier indoor air from the use of this product.

The energy efficiency of this ENERGY STAR qualified model is measured based on a ratio between the model's CADR for Dust and the electrical energy it consumes, or CADR/Watt.

Ce produit a le droit de porter la marque ENERGY STAR après avoir répondu à des critères stricts en ce qui concerne l'efficacité énergétique, tels qu'établis par l'agence EPA aux E-U. L'agence EPA aux E-U n'appuie aucunement les témoignages publicitaires du fabricant indiquant que ce produit rend l'air intérieur des locaux plus sain.

L'efficacité énergétique de ce modèle, qui bénéficie de la reconnaissance ENERGY STAR, est mesurée par le rapport entre le DAP (débit d'air purifié) du modèle et l'énergie électrique qu'il consomme, soit le rapport DAP/Watt.

AIR PURIFIER with Humidifying Function OPERATION MANUAL

Purificateur d'air à fonction d'humidification MANUEL D'UTILISATION

PURIFICADOR DE AIRE Con función de humidificación MANUAL DE OPERACIÓN

ENGLISH

FRANÇAIS

ESPAÑOL



FACTORY
USE ONLY

Please read before operating your new Air Purifier

The air purifier draws in room air from the air intake, passes the air through a Pre-Filter, a Washable Deodorizing filter and a True HEPA filter inside of the unit, then discharges the air through the air outlet. The True HEPA filter can remove 99.97% of dust particles as small as 0.3 microns that pass through the filter and also helps absorb odors. The Washable Deodorizing filter gradually absorbs odors as they pass through the filter.

Some odors absorbed by the filters may break down over time, resulting in additional odor. Depending on the usage environment, especially when the product is used in extreme environments (significantly more severe than normal household use), this odor may become strong in a shorter period than expected. If the odor persists, the filters should be replaced.

NOTE

- The air purifier is designed to remove air-suspended dust and odour, but not harmful gases (for example, carbon monoxide contained in cigarette smoke). If the source of the odor still exists, the air purifier may not completely remove the odor.

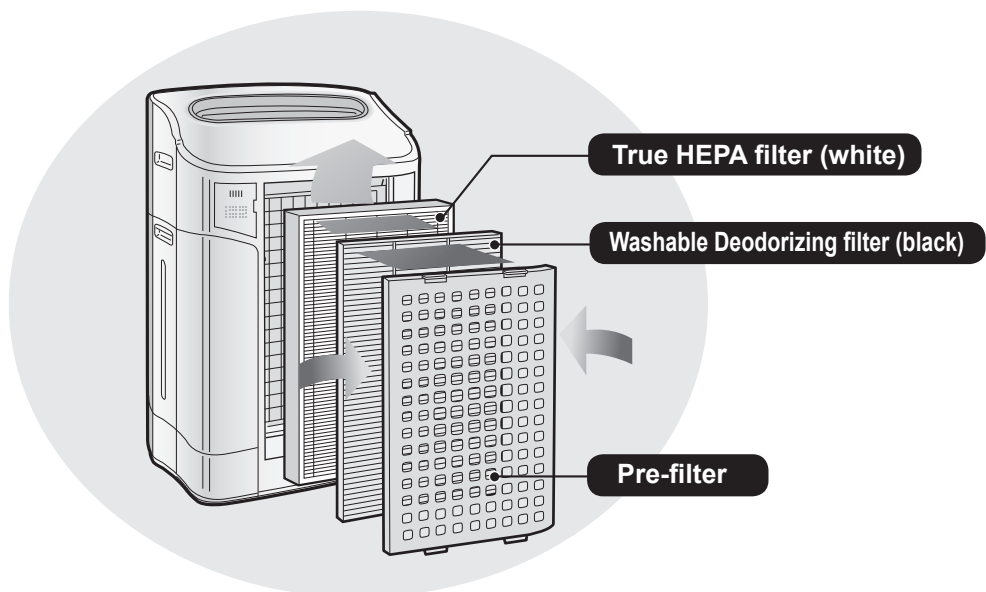

FEATURES

Unique Combination of Air Treatment Technologies
Triple Filtration System + Plasmacluster + Humidification

TRAPS DUST*

Washable pre-filter traps dust and other large airborne particles.

DECREASES ODORS

Washable deodorizing filter absorbs many common household odors.

REDUCES POLLEN & MOLD*

True HEPA filter traps 99.97% of particles as small as 0.3 microns.

FRESHENS

Plasmacluster refreshes the air similar to the way nature cleans the environment by emitting a balance of positive and negative ions.

HUMIDIFIES

Runs up to 10 hours per filling.**

*When air is drawn through the filter system.

**Room size : up to 341 sq. ft.

Sensor Technology continuously monitors air quality, automatically adjusting operation based on detected air purity and humidity.

Declaration of Conformity

SHARP AIR PURIFIER KC-860U

This device complies with Part 18 of FCC rules.

Responsible Party:

SHARP ELECTRONICS CORPORATION
100 Paragon Drive, Suite #100
Montvale, NJ 07645, U.S.A.

Declaration of Conformity

SHARP AIR PURIFIER KC-860U

This ISM device complies with Canadian ICES-001

Responsible Party:

SHARP ELECTRONICS OF CANADA LTD.
335 Britannia Road East Mississauga, Ontario
L4Z 1W9 Canada
TEL: (905) 568-7140

CONTENTS

FOR CUSTOMER ASSISTANCE(U.S)	E-2
CONSUMER LIMITED WARRANTY(U.S).....	E-3
FOR CUSTOMER ASSISTANCE(CANADA)	E-4
LIMITED WARRANTY(CANADA)	E-5
IMPORTANT SAFETY INSTRUCTIONS ...	E-6
• WARNING	E-6
• CAUTIONS CONCERNING OPERATION ..	E-7
• INSTALLATION GUIDELINES.....	E-7
• FILTER GUIDELINES	E-7
PART NAMES.....	E-8
• ILLUSTRATIVE DIAGRAM.....	E-8
• BACK.....	E-8
• MAIN UNIT DISPLAY	E-9
• FRONT MONITOR	E-9
PREPARATION FOR USE	E-10
• FILTER INSTALLATION	E-10
• REFILLING WATER TANK	E-11
OPERATION	E-12
• CLEAN AIR & HUMIDIFY MODE	E-12
• CLEAN AIR MODE	E-12
• QUICK CLEAN MODE	E-13
• FAN SPEED BUTTON.....	E-13
• Plasmacluster ON/OFF BUTTON.....	E-13
• POWER ON/OFF BUTTON.....	E-13
• LIGHTS CONTROL BUTTON	E-14
• WATER SUPPLY INDICATOR LIGHT	E-14
• ADJUSTMENT OF SENSOR DETECTION SENSITIVITY ..	E-14
CARE AND MAINTENANCE	E-15
• FILTER INDICATOR LIGHT	E-15
• BACK PANEL AND SENSORS	E-15
• MAIN UNIT	E-15
• WATER TANK.....	E-16
• WASHABLE DEODORIZING FILTER	E-16
• HUMIDIFYING TRAY	E-17
• HUMIDIFYING FILTER.....	E-18
• FILTER REPLACEMENT GUIDELINES.....	E-19
TROUBLESHOOTING	E-20
SPECIFICATIONS.....	E-22

Thank you for purchasing this SHARP Air Purifier. Please read this manual carefully before using the air purifier.

After reading, keep the manual in a convenient location for future reference.

FOR CUSTOMER ASSISTANCE (the United States)

To aid in answering questions if you call for service or for reporting loss or theft, please use the space below to record the model and serial number located on the back of the unit.

MODEL NUMBER

SERIAL NUMBER

DATE OF PURCHASE

Dealer Name

Address

City

State

Zip

Telephone

TO PHONE: Dial 1-800-BE-SHARP (237-4277) for:
SERVICE (for your nearest Sharp Authorized Servicer)
PARTS (for your Authorized Parts Distributor)
ACCESSORIES
ADDITIONAL CUSTOMER INFORMATION

TO WRITE: For service problems, warranty information, missing items and other assistance:
Sharp Electronics Corporation
Customer Assistance Center
Sharp Plaza Blvd.
Memphis, TN 38193

TO ACCESS OUR WEB SITE: www.sharpusa.com

Please provide the following information when you write or call: model number, serial number, date of purchase, your complete mailing address (including zip code), your daytime telephone number (including area code) and description of the problem.

CONSUMER LIMITED WARRANTY

CONSUMER LIMITED WARRANTY FOR U.S. USERS

SHARP ELECTRONICS CORPORATION warrants to the first consumer purchaser that this Sharp brand product (the "Product"), when shipped in its original container, will be free from defective workmanship and materials, and agrees that it will, at its option, either repair the defect or replace the defective Product or part thereof with a new or remanufactured equivalent at no charge to the purchaser for parts or labor for the period(s) set forth below.

This warranty does not apply to any appearance items of the Product nor to the additional excluded item(s) set forth below nor to any Product the exterior of which has been damaged or defaced, which has been subjected to improper voltage or other misuse, abnormal service or handling, or which has been altered or modified in design or construction.

In order to enforce the rights under this limited warranty, the purchaser should follow the steps set forth below and provide proof of purchase to the servicer.

The limited warranty described herein is in addition to whatever implied warranties may be granted to purchasers by law. ALL IMPLIED WARRANTIES INCLUDING THE WARRANTIES OF MERCHANTABILITY AND FITNESS FOR USE ARE LIMITED TO THE PERIOD(S) FROM THE DATE OF PURCHASE SET FORTH BELOW. Some states do not allow limitations on how long an implied warranty lasts, so the above limitation may not apply to you.

Neither the sales personnel of the seller nor any other person is authorized to make any warranties other than those described herein, or to extend the duration of any warranties beyond the time period described herein on behalf of Sharp.

The warranties described herein shall be the sole and exclusive warranties granted by Sharp and shall be the sole and exclusive remedy available to the purchaser. Correction of defects, in the manner and for the period of time described herein, shall constitute complete fulfillment of all liabilities and responsibilities of Sharp to the purchaser with respect to the Product, and shall constitute full satisfaction of all claims, whether based on contract, negligence, strict liability or otherwise. In no event shall Sharp be liable, or in any way responsible, for any damages or defects in the Product which were caused by repairs or attempted repairs performed by anyone other than an authorized servicer. Nor shall Sharp be liable or in any way responsible for any incidental or consequential economic or property damage. Some states do not allow the exclusion of incidental or consequential damages, so the above exclusion may not apply to you.

THIS WARRANTY GIVES YOU SPECIFIC LEGAL RIGHTS. YOU MAY ALSO HAVE OTHER RIGHTS WHICH VARY FROM STATE TO STATE.

<u>Your Product Model Number & Description:</u>	KC-860U Air Purifier. Be sure to have this information available when you need service for your Product.
<u>Warranty Period for this Product:</u>	One (1) year parts and labor from date of purchase.
<u>Additional Item(s) Excluded From Warranty Coverage:</u>	Appearance items of the Product, filters, accessories, or any printed materials. Product which has been used for rental and/or commercial purposes.
<u>Where to Obtain Service:</u>	From a Sharp Authorized Servicer located in the United States. To find the location of the nearest Sharp Authorized Servicer, call Sharp Toll Free at 1-800-BE-SHARP.
<u>What to Do to Obtain Service:</u>	Ship prepaid or carry in your Product to a Sharp Authorized Servicer. Be sure to have Proof of Purchase available. If you ship the Product, be sure it is insured and packaged securely.

TO OBTAIN SUPPLY, ACCESSORY OR PRODUCT INFORMATION, CALL 1-800-BE-SHARP, OR VISIT OUR WEBSITE AT www.sharppusa.com

SHARP®

SHARP ELECTRONICS CORPORATION

100 Paragon Drive, Suite #100, Montvale, NJ 07645, U.S.A.

FOR CUSTOMER ASSISTANCE (Canada)

To aid in answering questions if you call for service or for reporting loss or theft, please use the space below to record the model and serial number located on the back side of the unit.

MODEL NUMBER

SERIAL NUMBER

DATE OF PURCHASE

Dealer Name

Address

City

Province

Postal Code

Telephone

TO PHONE: Dial 1-905-568-7140 for:
SERVICE (for your nearest Sharp Authorized Servicer)
PARTS (for your Authorized Parts Distributor)
ACCESSORIES
ADDITIONAL CUSTOMER INFORMATION

TO WRITE: For service problems, warranty information, missing items and other assistance:
Sharp Electronics of Canada Ltd.
Customer Care
335 Britannia Road East
Mississauga, Ontario L4Z 1W9

TO ACCESS OUR WEB SITE: www.sharp.ca

Please provide the following information when you write or call: model number, serial number, date of purchase, your complete mailing address (including Postal Code), your daytime telephone number (including area code) and description of the problem.

SHARP®

LIMITED WARRANTY (VALID IN CANADA ONLY) Consumer Electronics Products Congratulations on your purchase!

Sharp Electronics of Canada Ltd. (hereinafter called "Sharp") gives the following express warranty to the first consumer purchaser for this Sharp brand product, when shipped in its original container and sold or distributed in Canada by Sharp or by an Authorized Sharp Dealer:

Sharp warrants that this product is free, under normal use and maintenance, from any defects in material and workmanship. If any such defects should be found in this product within the applicable warranty period, Sharp shall, at its option, repair or replace the product as specified herein.

This warranty shall not apply to:

- (a) Any defects caused or repairs required as a result of abusive operation, negligence, accident, improper installation or inappropriate use as outlined in the owner's manual.
- (b) Any Sharp product tampered with modified, adjusted or repaired by any party other than Sharp, Sharp's Authorized Service Centres or Sharp's Authorized Servicing Dealers.
- (c) Damage caused or repairs required as a result of the use with items not specified or approved by Sharp, including but not limited to head cleaning tapes and chemical cleaning agents.
- (d) Any replacement of accessories, glassware, consumable or peripheral items required through normal use of the product including but not limited to earphones, remote controls, AC adapters, batteries, temperature probe, stylus, trays, filters, belts, ribbons, cables and paper.
- (e) Any cosmetic damage to the surface or exterior that has been defaced or caused by normal wear and tear.
- (f) Any damage caused by external or environmental conditions, including but not limited to transmission line/power line voltage or liquid spillage.
- (g) Any product received without appropriate model, serial number and CSA and/or cUL markings.
- (h) Any products used for rental or commercial purposes.
- (i) Any installation, setup and/or programming charges.

Should this Sharp product fail to operate during the warranty period, warranty service may be obtained upon delivery of the Sharp product together with proof of purchase and a copy of this LIMITED WARRANTY statement to an Authorized Sharp Service Centre or an Authorized Sharp Servicing Dealer. In home warranty service may be provided at Sharp's discretion on any Sharp television with the screen size of 27" or larger and on any Sharp Over-the-Range Microwave Oven.

This warranty constitutes the entire express warranty granted by Sharp and no other dealer, service centre or their agent or employee is authorized to extend, enlarge or transfer this warranty on behalf of Sharp. To the extent the law permits, Sharp disclaims any and all liability for direct or indirect damages or losses or for any incidental, special or consequential damages or loss of profits resulting from a defect in material or workmanship relating to the product, including damages for the loss of time or use of this Sharp product or the loss of information. The purchaser will be responsible for any removal, reinstallation, transportation and insurance costs incurred. Correction of defects, in the manner and period of time described herein, constitute complete fulfillment of all obligations and responsibilities of Sharp to the purchaser with respect to the product and shall constitute full satisfaction of all claims, whether based on contract, negligence, strict liability or otherwise.

WARRANTY PERIODS:

	Parts & Labour (exceptions noted)
Audio Products	1 year
Camcorder	1 year
DVD Products	1 year
LCD Projector	1 year (lamp 90 days)
LCD TV	1 year
Microwave Oven	1 years (magnetron component-4 additional years)
Television Products	1 year (picture tube component-1 additional year)
VCR Products	1 year
Vacuum Cleaner	1 year
Air Purifier & Air Conditioners	1 year (except filters)

To obtain the name and address of the nearest Authorized Sharp Service Centre or Dealer, please contact:
SHARP ELECTRONICS OF CANADA LTD. 335 Britannia Road, East Mississauga, Ontario L4Z 1W9

For more information on this Warranty, Sharp Canada Products, Accessory Sales, Dealer or Service Locations, please call
(905)568-7140

Visit our Web site: www.sharp.ca



IMPORTANT SAFETY INSTRUCTIONS

When using electrical appliances, basic safety precautions should be followed, including the following:

WARNING - To reduce the risk of electrical shock, fire or injury to persons:

- Read all instructions before using the unit.
- Use only a 120 volt outlet.
- The air purifier has a polarized plug (one blade is wider than the other). This plug will fit in a polarized outlet only one way. If the plug does not fit into the outlet, reverse it. If it still does not fit, contact a qualified electrician or service person.
- **Do not use the unit if the power cord or plug is damaged or the connection to the wall outlet is loosened.**
- Periodically remove dust from the plug.
- **Do not insert fingers or foreign objects into the air intake or air outlet.**
- **When removing the power plug, always hold the plug and never pull on the cord.** Electrical shock and/or fire from a short circuit may occur as a result.
- **Do not remove the plug when your hands are wet.**
- **Do not use this unit near gas appliances or fireplaces.**
- When refilling the Water Tank, cleaning the unit, or when the unit is not in use, be sure to unplug the unit. Electrical shock and/or fire from a short circuit may occur as a result.
- **If the power cord is damaged, it must be replaced by the manufacturer, its service agent, a Sharp Authorized Service Center or similarly qualified person in order to avoid a hazard.**
- Do not operate when using aerosol insecticides or in rooms where there is oily residue, incense, sparks from lit cigarettes, chemical fumes in the air, or in locations where the unit may get wet, such as a bathroom.
- Be cautious when cleaning the unit. Strong corrosive cleansers may damage the exterior.
- Only a Sharp Authorized Service Center should service this air purifier. Contact the nearest Service Center for any problems, adjustments, or repairs.
- When carrying the unit, remove the Water Tank and Humidifying Tray first and hold the unit by handles on both sides.
- Do not drink the water in the Humidifying Tray or Water Tank.
- Change the water in the Water Tank daily with fresh tap water and regularly clean the Water Tank and Humidifying Tray. (See E-16 and E-17). When unit is not in use, dispose of the water in the Water Tank and Humidifying Tray. Leaving water in the Water Tank and/or Humidifying Tray may result in mold, bacteria and bad odors.
In rare cases, this bacteria may cause harmful physical effects.

NOTE - Radio or TV Interference

If this air purifier should cause interference to radio or television reception, try to correct the interference by one or more of the following measures:

- Reorient or relocate the receiving antenna.
- Increase the separation distance between the unit and radio/TV receiver.
- Connect the equipment into an outlet on a circuit different from that to which the receiver is connected.
- Consult the dealer or an experienced radio/TV technician for help.

This product fulfils the requirement of the International standard CISPR 11.

In conformity with this standard, this product is classified as group 2 class B equipment.

Group 2 means that the equipment intentionally generates radio-frequency in the form of electromagnetic radiation for electro-discharge machining equipment.

Class B equipment means that the equipment suitable to be used in domestic establishments.

CAUTIONS CONCERNING OPERATION

- Do not block the intake and/or air outlet.
- Do not use the unit near or on hot objects, such as stoves or heaters or where it may come into contact with steam.
- Always operate the unit in an upright position.
- **Always hold the handles on both sides of the unit when moving it.**
Holding the back panel when carrying may cause it to detach, thus dropping the unit and resulting in bodily injury.
- **Do not operate the unit without the filters, Water Tank, and Humidifying Tray properly installed.**
- **Do not wash and reuse the True HEPA filter.**
Washing will not improve filter performance, it may cause electric shock or malfunction.
- **Clean the exterior with a soft cloth only.**
Do not use volatile fluids and/or detergents.
The unit surface may be damaged or cracked.
In addition, the sensors may malfunction as a result.
- **Frequency of maintenance required (descaling) will depend on the hardness or the impurities of the water that you use; the harder the water the more often descaling will be necessary.**
- **Keep the unit away from water.**

INSTALLATION GUIDELINES

- **During the operation of the product, please place the unit at least 6.5ft. (2m) away from equipment utilizing electrical waves such as televisions, radios or wave clocks.**
- **Avoid a location where the sensor is exposed to direct breeze or draft.**
The unit may not operate properly.
- **Avoid use in locations where furniture, fabrics or other items may come in contact with and restrict the air intake and/or air outlet.**
- **Avoid use in locations where the unit is exposed to condensation or rapid temperature changes. (Use under appropriate conditions between 41 - 95°F (5 - 35°C) in the room.)**
(If it is unavoidable please allow unit to stand for 1 hour before switching on.)
- **Place on a stable surface with sufficient air circulation.**
When placing the unit on a heavily carpeted area, the unit may vibrate slightly.
Place the unit on an even surface to avoid water leakage from the Water Tank and/or Humidifying Tray.
- **Avoid use in locations where grease or oily smoke is generated.**(such as in a kitchen, etc.).
The unit surface may crack or the sensor may malfunction as a result.
- **Place the unit about 1-2 ft. (30 - 60cm) away from the wall in order to ensure proper airflow.**
The wall directly behind the air outlet may become dirty over time. When using the unit for an extended period of time in the same location, periodically clean the wall and protect the wall with a vinyl sheet, etc. to prevent the wall from becoming dirty.

FILTER GUIDELINES

- Follow the instructions in this manual for correct care and maintenance of the filters.
Use only filters designed for this product.

PART NAMES

ILLUSTRATIVE DIAGRAM - FRONT

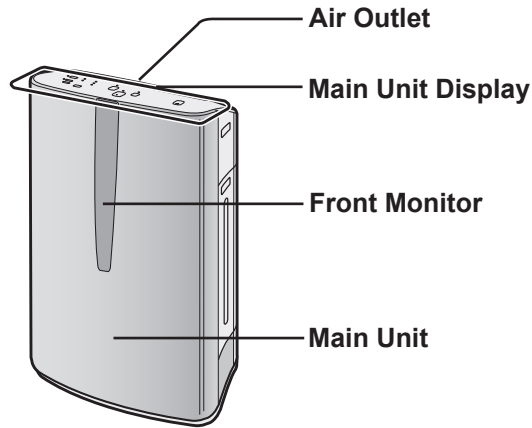

BACK

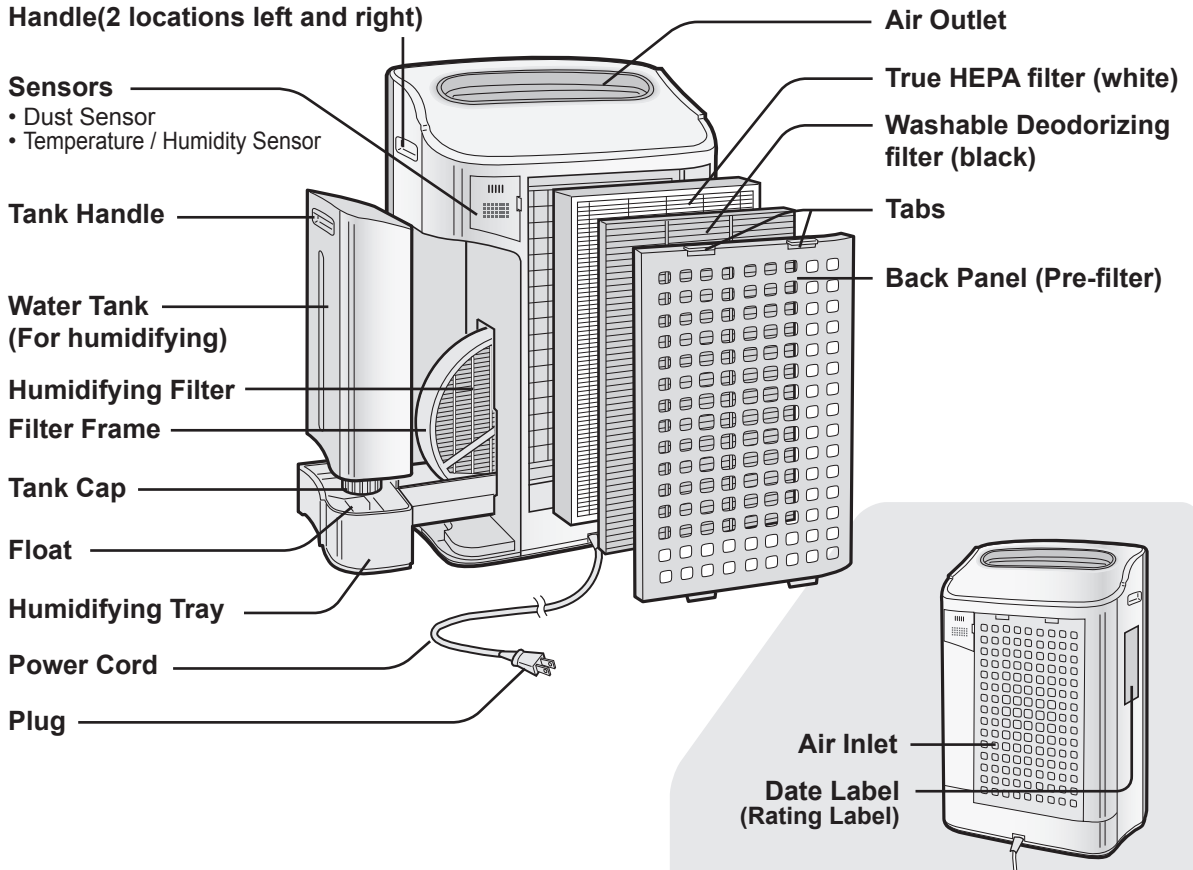

MAIN UNIT DISPLAY

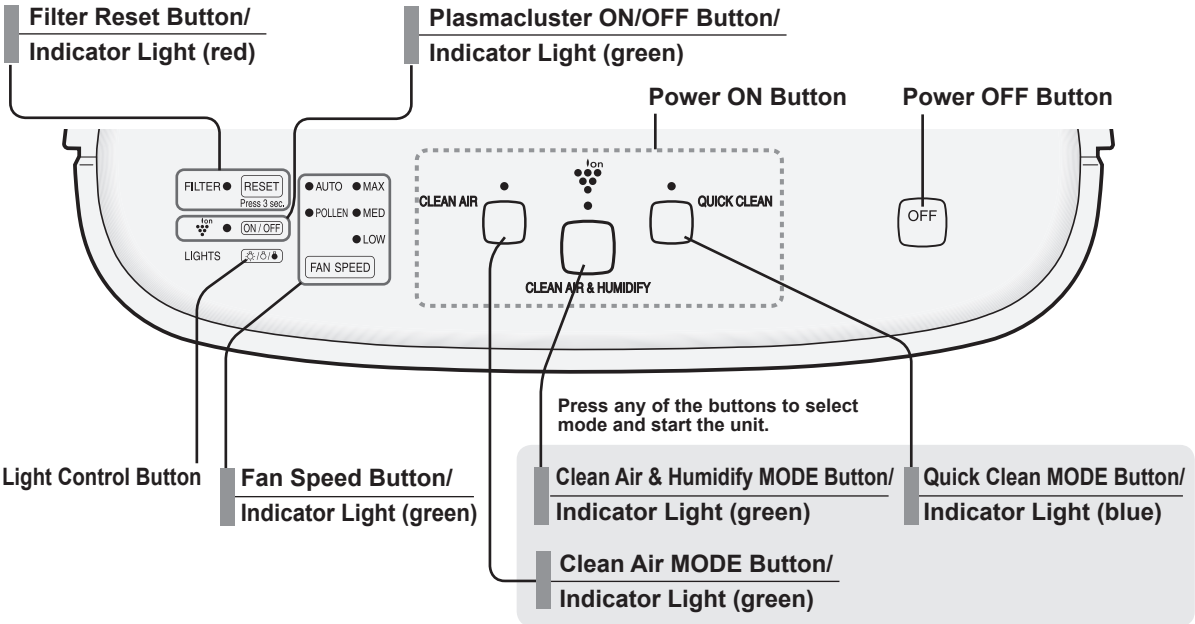

FRONT MONITOR

Indicates condition and humidity of room air.

DUST MONITOR

The dust sensor continuously monitors the air and changes color depending on air purity.

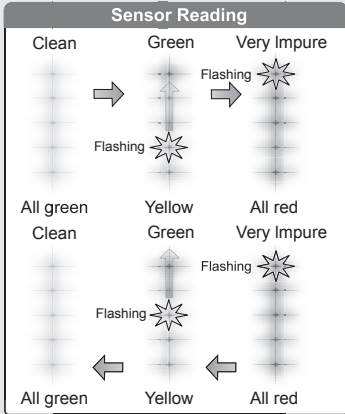

When the dust sensor detects dust, the flashing light moves depending on the amount of dust detected.

Plasmacluster Indicator Light (blue)
 Blue: Plasmacluster ON
 Light off: Plasmacluster OFF

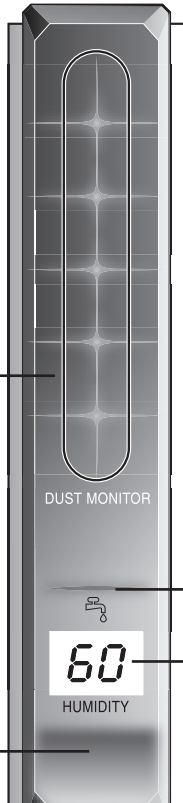

Water Supply Indicator Light (red)
 This light will illuminate when the water tank needs to be refilled.

Humidity Indicator Light (green)
 Displays the approximate humidity level in the room. Humidity setting is pre-set for maximum comfort.

(Ex.) At 60 % humidity
 80 % or more *H* ,
 Less than 30 % *Lo*



PREPARATION FOR USE

Unplug the unit before installing or adjusting the filters.

FILTER INSTALLATION

To maintain the quality of the filters, they are packed in plastic bags and placed in the unit. Be sure to remove the filters from the plastic bags and replace the filters in the unit before initial use.

1 Remove the filters

1 Remove the Back Panel.

Gently push down on the tabs, then tilt and remove the back panel.

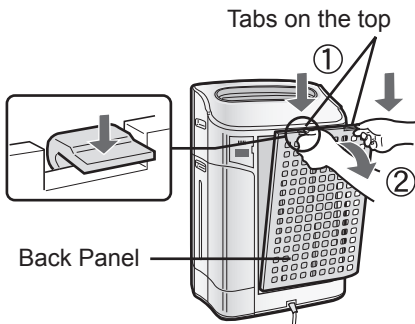

2 Remove the Washable Deodorizing filter (black) and True HEPA filter (white) from the plastic bags.

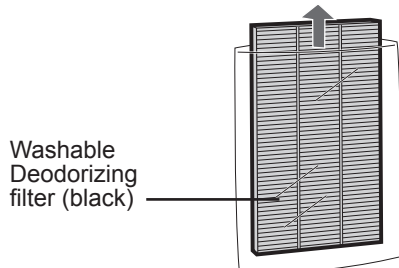
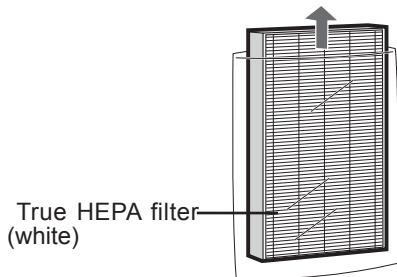

2 Install the filters

1 Install the True HEPA filter.

Please make sure that the True HEPA filter is placed in proper orientation.

Installing the filter backwards will affect the performance of the unit.

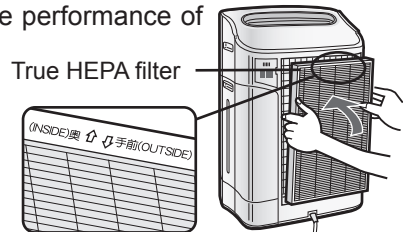

2 Insert the Back Panel's 2 bottom tabs (left and right) into the small holes in the unit, and slide the Washable Deodorizing filter between the True HEPA filter and the Back Panel.

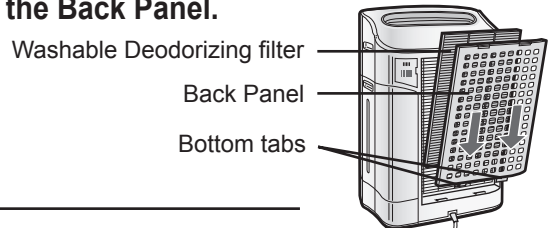

3 Gently push in the upper tabs (left and right) to lock in place.

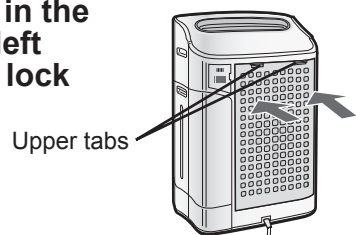

4 Fill in the usage start date and place on the unit as guide for when the filters should be replaced.

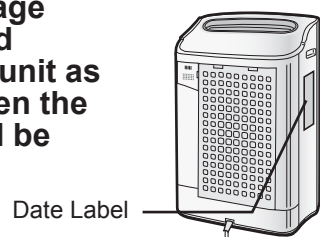

REFILLING THE WATER TANK

The unit can be used in the Clean Air Mode without putting water in the Water Tank. When using the Clean Air & Humidify Mode, or the Quick Clean Mode, the Water Tank should be filled with water.

1 Remove the Water Tank by unlatching the top.

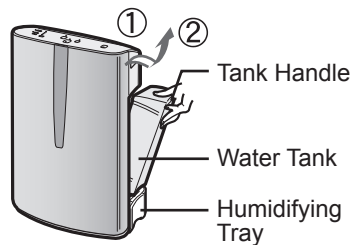

2 Remove the Water Tank Cap and carefully fill the Water Tank with tap water.

- Change the water in the Water Tank every day with fresh tap water.

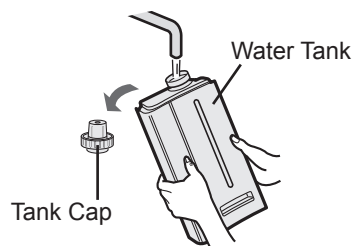

3 After filling, securely tighten the Tank Cap.

- Check to see that there is no water leaking.
- Be sure to wipe off any excess water on the outside of the Water Tank.
- When carrying the Water Tank, hold it with both hands so that the Water Tank opening is facing up.

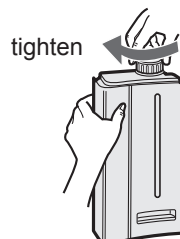

4 Replace the Water Tank in the unit.

- The top latch will “click” in place when the Water Tank is properly installed.

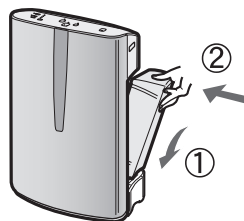

CAUTION

- Do not expose the unit to water. Short circuit and/or electrical shock may occur as a result.
- Do not use hot water (104°F or 40°C), chemical agents, aromatic substances, dirty water, or other damaging substances, deformation and/or malfunction may occur.
- Use only fresh tap water. Use of other water sources may promote the growth of mold, fungus and/or bacteria.

OPERATION

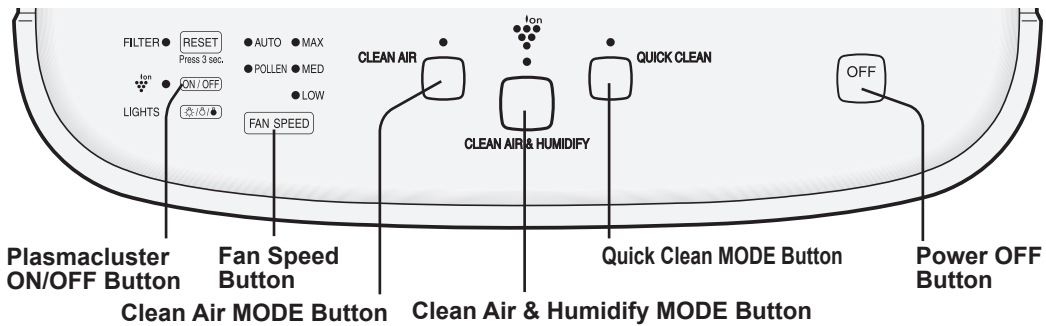

CLEAN AIR & HUMIDIFY MODE

Use the Clean Air & Humidify Mode to quickly clean the air, reduce odors and to humidify.

1 Fill Water Tank. (See E-11)

2 Press the **CLEAN AIR & HUMIDIFY MODE Button**.

- If the power cord was not unplugged between uses, the unit will automatically re-start at the previously selected settings.



3 Press the **FAN SPEED Button** to select the desired fan speed. (See E-13)



About Automatic Humidify Mode

The Temperature/Humidity sensors automatically detect and adjust humidity according to changes in room temperature. Depending on the size and humidity of the room, humidity may not reach 45 - 55 %. In such cases, it is recommended that CLEAN AIR & HUMIDIFY/MAX MODE be used.

Temperature	Humidity
64 and below	55%
64-75	50%
75 and above	45%

CLEAN AIR MODE

Use the Clean Air Mode when additional humidity is not required.

1 Press the **CLEAN AIR MODE Button** on the display.

- If the power cord was not unplugged between uses, the unit will automatically re-start at the previously selected settings.



2 Press the **FAN SPEED BUTTON** to select the desired fan speed. (See E-13)



QUICK CLEAN MODE

QUICK CLEAN Mode with humidification releases high-density Plasmacluster ions. By continuously discharging strong airflow cycles, the unit effectively removes airborne dust, pollen, mold and allergens from the air as they are drawn through the filter system. Water must be in the Water Tank when this mode is selected.

The unit humidifies when there's water in the Water Tank, and it operates without humidifying when there is no water in it.

1 Press the QUICK CLEAN MODE Button on the display to select this mode.

When the operation finishes, the unit will return to the prior operation.



FAN SPEED Button

Press the FAN SPEED Button to select the preferred fan settings. Indicator lights will show the speed currently selected. Please note the fan speed cannot be adjusted during the QUICK CLEAN Mode.



AUTO operation AUTO

The fan speed is automatically switched (HIGH*, MEDIUM, LOW) depending on the amount of impurities in the air. The sensors detect the impurities for efficient air purification.

POLLEN mode operation POLLEN

The unit will operate at High level for 10 minutes, then will alternated between MED and HIGH every 20 minutes.

MAX operation MAX

The unit will operate at maximum fan speed .

MEDIUM operation MED

The unit will operate at medium fan speed .

LOW operation LOW

The unit will operate quietly using minimal air intake.

* HIGH fan speed is an intermediate speed between MEDIUM and MAX.

Plasmacluster ON/OFF Button

Press the Plasmacluster ON/OFF Button to turn Plasmacluster Ion Mode ON and OFF. When Plasmacluster is ON, both the Indicator Light and Plasmacluster Indicator Light on the front display turn on.

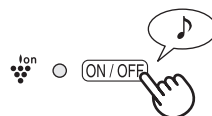

POWER OFF Button

Press the Power OFF Button to turn the unit off.



OPERATION

LIGHTS CONTROL Button

Use when the light on the front panel is too bright.

Refer to the diagram to select the desired brightness on the front panel.

LIGHTS

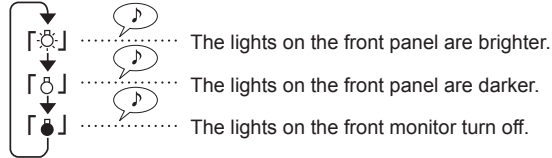

CAUTION

The lights on the front monitor are always brighter when starting.

WATER SUPPLY INDICATOR LIGHT

When the Water Tank is empty, the Water Supply Indicator Light will flash to indicate that the Water Tank should be refilled. **Please note the light will not flash even when the Water Tank is empty during the Clean Air Mode and the Quick Clean Mode.**

Sound indicator setting for water supply.

In addition to the Indicator Light, the unit can be set to signal with an audible beep when the Water Tank is empty. With the unit OFF, press the Lights Control button for 3 seconds to turn the audible signal ON.

Cancellation

To cancel the audible signal, with the unit OFF, press the Lights Control button again more than 3 seconds.



LIGHTS



ADJUSTMENT OF SENSOR DETECTION SENSITIVITY

Set to 'low' if the DUST MONITOR is constantly red to reduce sensitivity, and set to 'high' if the DUST MONITOR is constantly green to increase sensitivity.

1 With the unit OFF, press the Fan Speed Button for 3 seconds.

The Fan Speed Indicator Lights will display the currently set sensor sensitivity level. The factory setting is Standard, indicated by the MED light.

2 Press the Fan Speed Button to set the desired sensor sensitivity.

Refer to the diagram on the right to select the desired sensor sensitivity level.

3 Press the Power OFF Button.

Note that if the Power OFF Button is not pushed within 8 seconds of adjusting sensor sensitivity, the setting will be saved automatically. The sensor sensitivity setting will be saved even if the unit is unplugged.

Fan Speed
Indicator Light

Sensor Detection
sensitivity

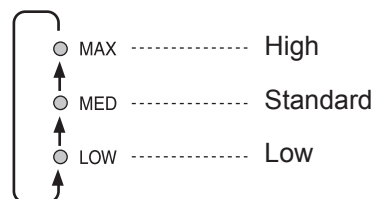

CARE AND MAINTENANCE

To maintain optimum performance of this air purifier, please clean the unit including the sensor opening and filters periodically.

When cleaning the unit, be sure to first unplug the power cord, and never handle the plug with wet hands. Electrical shock and/or bodily injury may occur as a result.

FILTER INDICATOR LIGHT

Care Cycle

After 720 hours of use
(30days ×24hours = 720)

The Filter Indicator Light will illuminate as a reminder to perform maintenance of the Back Panel, Sensors, and Humidifying filter. The Indicator Light will turn on after approximately 720 hours of use.

After performing maintenance, reset the Filter Indicator. Plug the unit in, turn power ON, and press the RESET button for 3 seconds. The Filter Indicator Light will go off. Even if the Filter Indicator Light is already off, the RESET button should be pressed to reset the maintenance timer.



BACK PANEL and SENSORS

Care Cycle

Whenever dust accumulates on the unit or every 2 months

Gently remove dust from the sensor opening and the back panel, using a vacuum cleaner attachment or similar tool.

When the back panel has stubborn dirt

- 1 In case of oily dirt, soak the back panel in water with kitchen detergent. Avoid scrubbing the back panel when washing.
- 2 Rinse the back panel repeatedly with clean water to remove the solution residue.
- 3 Drip dry panel to remove excess water.

SENSOR FILTER CARE

Remove the sensor filter and tap it lightly over a sink or bin to dislodge dust. If it is very dirty, wash it gently with lukewarm water. **Do not use any detergents or chemicals of any kind to clean the filter.** Dry the filter completely before replacing in the unit. Do not operate unit without all filters properly installed.

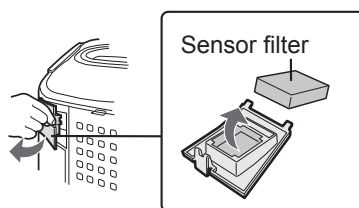
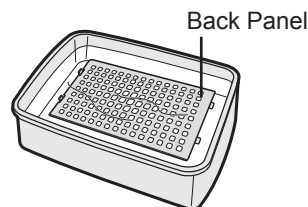
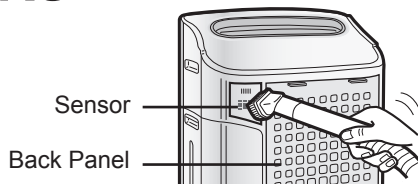

UNIT

Care Cycle

Whenever dust accumulates on the unit or every 2 months

To prevent dirt or stains on the unit, clean regularly. If stains are allowed to remain, they may become difficult to remove.

Wipe with a dry, soft cloth

For stubborn stains or dirt, use a soft cloth dampened with warm water.

Do not use volatile fluids

Benzene, paint thinner, polishing powder, may damage the surface.

Do not use detergents

Detergent ingredients may damage the unit.

CARE AND MAINTENANCE

WATER TANK

Care Cycle Every day when Humidifying

Rinse the inside of the tank by leaving a small amount of lukewarm water inside, closing the tank cap firmly, and shaking the tank. Mild household detergents may be used to clean the inside of the tank, but detergent should be diluted and the tank should be thoroughly rinsed to remove all detergent residue.

(Note the Water Tank is not dishwasher safe.)

TANK CAP CARE <care cycle... once a month>

The small cap back of the tank cap is removable. When the tank cap and small cap are dirty and/or slimy, cleaning is necessary. Use a cotton swab or a toothbrush.

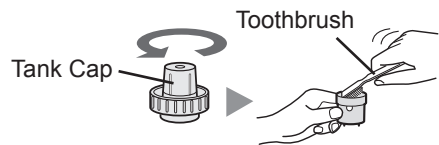
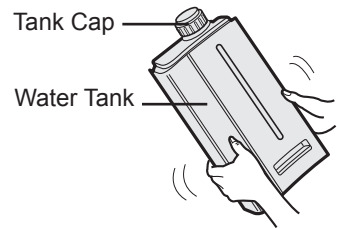

WASHABLE DEODORIZING FILTER CARE

**HAND WASH ONLY!
DO NOT DRY IN CLOTHES
DRYER!**

Care Cycle

When an unpleasant odor is noticed from the air outlet.
When performance of filter seems to be reduced and odors persist.

1 Rinse dirt from the WASHABLE DEODORIZING FILTER under lukewarm water.

CAUTION

- When washing the filter for the first time, the rinse water may be brown. This does not affect deodorization performance.
- Avoid bending or folding the filter when washing.

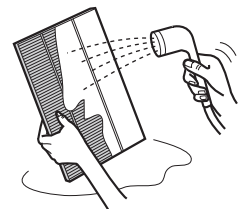

2 Drip dry filter to remove excess water.

3 Dry filter completely in a well ventilated area. If possible, dry outdoors.

Dry filter in a sideways position to avoid warping of the filter. The filter takes about 6 hours to dry completely.

CAUTION

- Avoid drying filter outdoors during inclement weather (e.g. rain or cold temperatures). Do not allow filter to freeze.
- If filter is dried indoors, take precautions, such as placing towels, etc under the filter to prevent water damage to the floor.

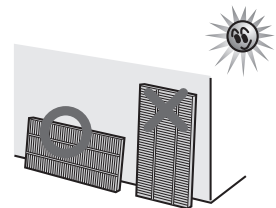

4 Replace the filter in unit. (See E-10).

Dry filter completely before replacing to prevent odors. Do not operate unit without all filters properly installed.

HUMIDIFYING TRAY

Care Cycle 1 month

Frequency of maintenance cycle will depend on the hardness of the water. Avoid spilling water when removing or cleaning the tray.

1 Remove the Water Tank and Humidifying Tray.

Unlatch the Water Tank first, then remove the tray. Use both hands when pulling out the Humidifying Tray to avoid spilling water.



2 Remove the Water Tank and Humidifying filter from the Humidifying Tray. Drain accumulated water by tilting the Humidifying Tray slowly.

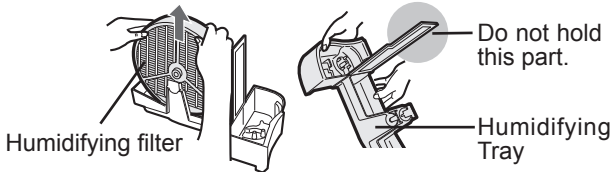

3 Rinse the inside of the Humidifying Tray with lukewarm water to remove impurities.

- Do not remove the Styrofoam float.
- Clean difficult-to-reach parts with a cotton-tipped swab or tooth brush.

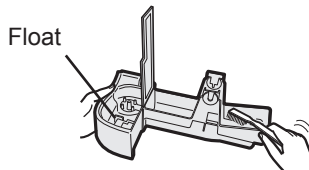

4 Replace the Humidifying filter and replace the Humidifying Tray in the unit.

The Humidifying filter will not fit if placed in backwards. Be sure there is no gap between the Humidifying tray and the unit when the Humidifying Tray is replaced in the unit. The unit may not operate properly if the Humidifying Tray is not properly replaced in the unit.

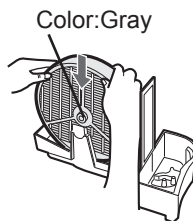

When Water Deposits are Difficult to Remove

1 Fill Humidifying Tray halfway with lukewarm water, add a small amount of mild kitchen detergent, and leave to soak for about 30 minutes.

Dilute detergent according to instructions on the container. Clean difficult-to-reach parts with a cotton swab or tooth brush.

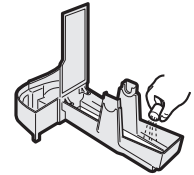

2 Rinse the Humidifying Tray with lukewarm water.

- Rinse until all detergent residue is removed.
- Inadequate rinsing may cause the detergent odor or changes in the shape/ color of the main unit.

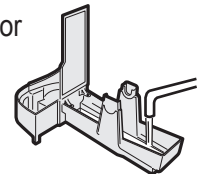

CAUTION

- Use only mild kitchen detergents to clean the Humidifying Tray. Use of non-designated chemicals or detergents can cause deformation, tarnishing, cracking (water leakage).

If the Styrofoam float comes off, replace by inserting the tabs of the Float into the holes in the Humidifying Tray as shown in the diagram.

- ② Insert the tab of the float into the hole.

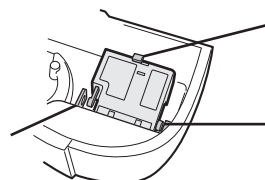

- ① Insert the float below this tab.

- ③ Insert the tab on the other side of the float into the hole.

CARE AND MAINTENANCE

HUMIDIFYING FILTER

Care Cycle Once a month or when the Filter Indicator Light is on.

Frequency of maintenance cycle will depend on the hardness or the impurities of the water that you use; the harder the water the more often descaling will be necessary.

Pay attention not to spill water when cleaning the filter.

1 Remove the Water Tank and Humidifying Tray.

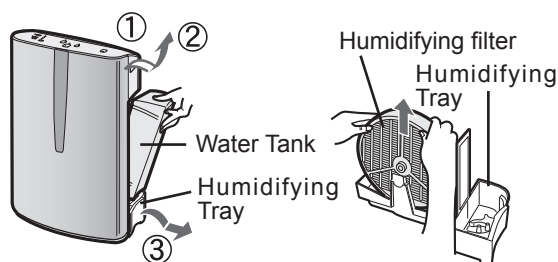

2 Remove the Humidifying filter from the Humidifying Tray.

Avoid spilling water from the Humidifying Tray.

3 Preparing the descaling solution.

Citric acid, available at some drugstores, or 100% bottled lemon juice are used for descaling. Choose either one to use, and prepare the descaling solution.

<For using citric acid>

Dissolve 3 teaspoons of citric acid and 2 1/2 cups of lukewarm water in a suitable container, and stir well.

<For using lemon juice>

100% bottled lemon juice can be used for descaling. Use only 100% bottled lemon juice with no pulp (strain juice if necessary). Combine 1/4 cup lemon juice and 3 cups of lukewarm water in a container large enough to hold the Humidifying filter and stir well.

4 Pre-soak the Humidifying filter in the solution for 30 minutes before cleaning.

When using lemon juice, it is recommended to pre-soak longer than citric acid.



5 Rinse the Humidifying filter repeatedly with lukewarm water to remove all the solution residue.

Inadequate rinsing may cause odor and affect the performance and/or appearance of the unit.

* Do not scrub the Humidifying filter, rinse gently under lukewarm water only.

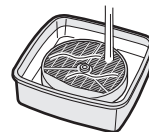

6 Attach the Humidifying filter to the Humidifying Tray, and replace the Humidifying Tray in the unit.

• The Humidifying filter will not fit if placed in backwards. Be sure there is no gap between the Humidifying tray and the unit when the Humidifying Tray is replaced in the unit. The unit may not operate properly if the Humidifying Tray is not properly replaced in the unit.

• When not using the unit for a long period of time, dry the Humidifying filter completely before replacing.

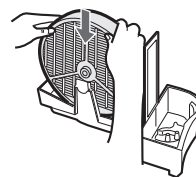

7 Plug in the unit, turn power ON, and press the Filter Reset Button on the display more than 3 seconds to reset.

You may notice reddish-brown or white deposits forming on the surface of the Humidifying filter. These impurities (calcium, etc.) are due to the impurities contained in tap water; this is not a defect. Replace the Humidifying filter when it is covered completely in white deposits.



FILTER REPLACEMENT GUIDELINES

Filter life will vary depending on the room environment, usage, and location of the unit. If dust or odors persist, replace the filters.

(Refer to "Please read before operating your new Air Purifier")

Guide for filter replacement timing

True HEPA filter Up to 5 years after opening

Filter life can be greatly reduced depending on the room environment. Cigarette smoke, pet dander, and other airborne particles can reduce filter life. Check filters regularly and replace as necessary.

Washable Deodorizing filter Up to 5 years after opening

The filter can be repeatedly used after washing, or it can be replaced.

Humidifying filter Up to 2 years after opening

Filter life can be greatly reduced depending on the room environment. Even if 2 years have not passed, replace the Humidifying filter if you notice the following:

- Mineral deposits (white, black, or red masses) which are not removed after cleaning or the Humidifying filter is still dirty.
- Filter is severely damaged or warped.

Replacement Filters

- True HEPA filter: 1 unit
Model FZ-C150HFU (for KC-860U)
- Washable Deodorizing filter: 1 unit
Model FZ-C150DFU (for KC-860U)
- Humidifying filter: 1 unit
Model FZ-C100MFU

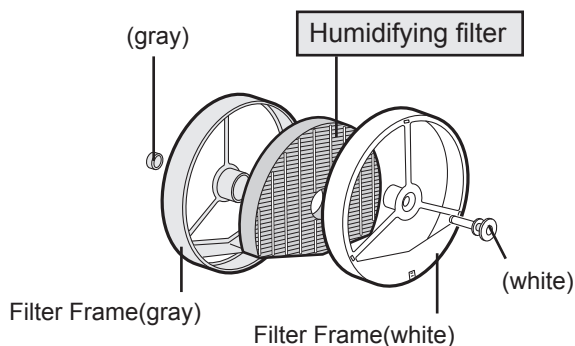

Replacing the Filters

1. Replace filters according to the instructions provided with the replacement filters.
2. Use the date labels as a reminder for when the filters should be replaced.

Disposal of Filters

Please dispose of used filters according to any local laws and regulations.

True HEPA filter materials:

- Filter: Polypropylene • Frame: Polyester

Washable Deodorizing filter Materials:

- Polyester, Rayon, Activated charcoal

Humidifying filter materials:

- Rayon, Polyester

TROUBLESHOOTING

Before calling for service, please review the Troubleshooting chart below, since the problem may not be a unit malfunction.

SYMPTOM	REMEDY(not a malfunction)
Odors and smoke are not removed.	<ul style="list-style-type: none"> • Clean or replace the filters if they appear to be heavily soiled. (See E-15,E-16,E-18)
The Front Monitor illuminates green even when the air is impure.	<ul style="list-style-type: none"> • The air could be impure at the time the unit was plugged in. Unplug the unit, wait one minute, and plug the unit in again.
The Front Monitor illuminates orange or red even when the air is clean.	<ul style="list-style-type: none"> • Sensor operation is affected if the dust sensor openings are dirty or clogged. Gently clean the dust sensors (See E-15).
A clicking or ticking sound is heard from the unit.	<ul style="list-style-type: none"> • Clicking or ticking sounds may be audible when the unit is generating ions.
The discharged air has an odor.	<ul style="list-style-type: none"> • Check to see if the filters are heavily soiled. • Clean or replace the filters. • Plasmacluster Air Purifiers may produce a slight odor. This is normal and is a result of the Plasmacluster Ions refreshing the air.
The unit does not operate when cigarette smoke is in the air.	<ul style="list-style-type: none"> • Is the unit installed in a location that is difficult for the sensor to detect cigarette smoke? • Are the dust sensor openings blocked or clogged? (In this case, clean the openings.) (See E-15)
Filter Indicator Light is illuminated.	<ul style="list-style-type: none"> • After cleaning or replacing filters, connect the power cord to an outlet and press the Filter Reset Button. (See E-15)
The Front Monitor are turned off.	<ul style="list-style-type: none"> • Check to see if the Lights OFF Mode selected. If so, then press the Lights Control Button to activate the indicator lights. (See E-14)
The Water Supply Indicator Light does not illuminate when the tank is empty.	<ul style="list-style-type: none"> • Check Styrofoam float for impurities. Clean the Humidifying Tray. Ensure unit is located on a level surface. Check to see if the Humidifying Tray and Water Tank are correctly installed.
Water level in the tank does not decrease or decreases slowly.	<ul style="list-style-type: none"> • Check to see if the Humidifying Tray and Water Tank are correctly installed. Check the Humidifying filter. • Clean or replace the filter when it is heavily soiled (See E-18 and E-19). Check to see if Clean Air & Humidify mode has been selected.
The Front Monitor lights change color frequently.	<ul style="list-style-type: none"> • The Dust Monitor lights automatically change colors as impurities are detected by the dust sensor.

ERROR DISPLAY

If error occurs again, contact the Sharp Service Center.

DIGITAL INDICATION	LAMP INDICATION	ERROR DETAILS	REMEDY
E2	Flashing of the Clean Air & Humidify Indicator Light.	Abnormal humidity filter.	Verify if the Humidifying filter, Humidifying Tray and Water Tank are properly installed and then turn power ON again.
C1	Flashing of the Fan Speed Indicator Light '○LOW'.	Abnormal fan motor.	Turn power OFF to cancel the error display, wait one minute, and then turn power ON.
C3	—	Abnormal temperature-humidity sensor.	Unplug the unit, wait one minute, and plug the unit in again.
C4	—		
C5	Flashing of the Quick Clean Indicator Light.	Problem in circuit board.	
C6	Flashing of the Clean Air Indicator Light.		
C7	Flashing of the Fan Speed Indicator Light '○POLLEN'.		
C8	Flashing of the Fan Speed Indicator Light '○AUTO'.		

SPECIFICATIONS

Model		KC-860U		
Power supply		120 V 60 Hz		
Fan Speed Adjustment		MAX	MED	LOW
CLEAN AIR	Fan Speed (CFM)	272	124	42
	Rated Power (W)	87	14	4.8
	Noise Level (dBA)	54	37	19
CLEAN AIR & HUMIDIFY	Fan Speed (CFM)	219	124	74
	Rated Power (W)	50	16	9
	Noise Level (dBA)	49	37	28
	Humidification (pints/hour)*2	1.5	0.9	0.6
Recommended Room Size *1		341 sq.ft (31.7 m ²)		
CADR (Dust/Smoke/Pollen)		231 / 220 / 245		
Water Tank Capacity (gallon)		1.14		
Sensors		Dust/Temperature & Humidity		
Filter type	Dust collection	True HEPA with Microbial control		
	Deodorization	Washable Deodorizing		
Cord Length		6.5ft (2.0m)		
Dimensions		398 (W) × 288 (D) × 627 (H) 15 3/4 in (W) x 11 3/8 in (D) x 24 3/4 in (H)		
Weight		25.8 lbs (11.7 kg)		

*1 •The Recommended Room Size is appropriate for operating the unit of maximum fan speed.

*2 •Humidification Amount changes in accordance with indoor and outdoor temperature and humidity.
Humidification Amount increases as temperatures rise or humidity decreases.
Humidification Amount decreases as temperatures decrease or humidity rises.

Standby Power

In order to operate the electrical circuits while the power plug is inserted in the wall outlet, this product consumes about 0.4 W of standby power.

For energy conservation, unplug the power cord when the unit is not in use.

