

# KCH24XV

## 24" CHIMNEY HOOD



Complete your Bertazzoni kitchen with this elegant stainless steel chimney hood.

Choose among 3 extraction airflow speeds, reaching a maximum flow performance of 600 CFM (cubic feet per minute).

Easily control all hood functions with ease using the push button controls.

Enjoy powerful illumination of the cooking surface with the long lasting and bright LED lights, which also don't create additional heat and are energy efficient.

Filter out odors and grease with the aluminum mesh filters, which can be easily cleaned periodically in the dishwasher or by hand.

This hood includes a telescopic duct cover reaching up to 9' high ceilings.

The hood comes standard for venting outside the kitchen, but can be easily modified for recirculation by installing the optional charcoal filter kit.

Designed and manufactured with pride by Bertazzoni in Italy.

Industry leading 2 years parts and labor warranty.

### PRODUCT FEATURES

Size	24"
Hood type	Wall mount
Hood finish	Stainless steel
Motor	1
Speed	3
Hood control	Push buttons
Lights	2 LED
Filters type	Aluminum mesh
Extraction power	600 CFM
Sound Level (min)	38 db(A)
Recirculation	Yes
Duct cover	Included
Duct size	6" diameter

### TECHNICAL SPECIFICATIONS

Electrical supply	120 V 60 HZ - 353 W 3.3 Amp
Power connection	NEMA 5-15P with 43" power cord
Certification	CSA
Warranty	2 years parts & labor
Packaging dimensions and weight	W 25 3/8" H 21 27/32" D 14 61/64" 19.84 lbs

### OPTIONAL ACCESSORIES

Z130018	Air flow restrictor
901488	Charcoal filters

# KCH24XV

## 24" CHIMNEY HOOD



### PRODUCT DIMENSIONS

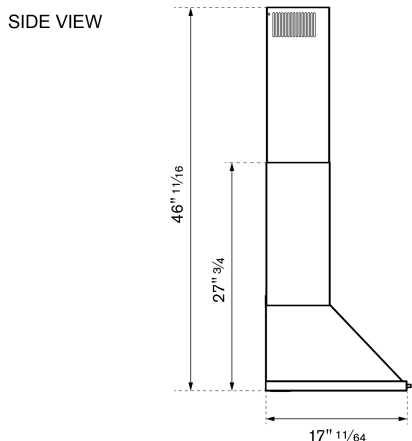
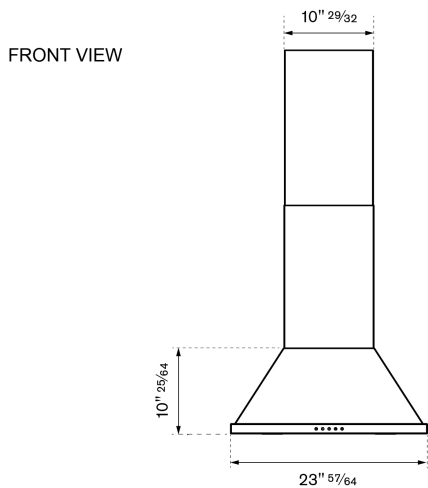

### PRODUCT INSTALLATION

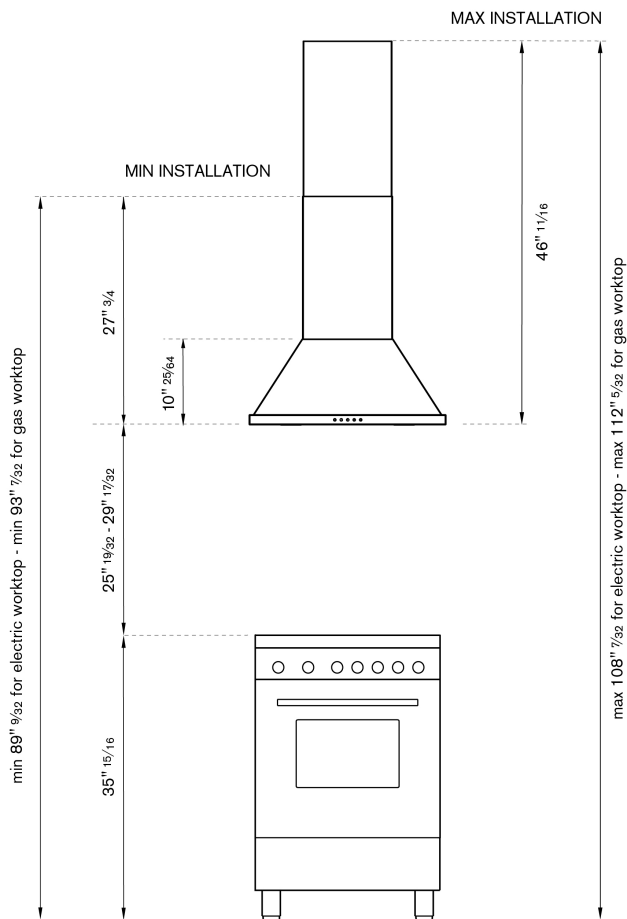

### Hood Clearance

Recommended height above cooking surface:  
 min 25" <sup>19</sup>/<sub>32</sub> for electric worktop  
 min 29" <sup>17</sup>/<sub>32</sub> for gas worktop

### ELECTRICAL CONNECTION

The Power Supply Cord and plug must be connected to a separate 120 Volt AC 60 Hz, 15 Amp or more branch circuit, single grounded receptacle. The cord has a 3-pronged plug and must be installed into an outlet that is properly grounded. The electrical receptacle must be within the minimum cord length of 43".

