



## HIGH POWERED. HIGH DESIGN.

This new **Viking RVL Collection** bridges present and future with a fully integrated design that fits seamlessly into surrounding cabinetry. Although its sleek look is decidedly minimal, it boldly conveys Viking performance at a glance. And rest assured, no commercial cooking power was sacrificed for appearance sake. With streamlined silhouettes, a sleek user interface, transitional sizes, and outfitted in stunning black glass this collection gives you limitless contemporary design possibilities that will ignite your culinary passions.

## MODEL NUMBER

**MVIC63014BBG** – 30"W. Induction Cooktop

**MVIC63615BBG** – 36"W. Induction Cooktop

## DESIGN AND INSTALLATION FEATURES

- All black glass top
- Electronic touch control
- Seamless integration
- Can be installed flush or integrated

## COOKING FEATURES

- MagneQuick Induction Elements utilize magnetic energy for superior power, responsiveness and efficiency
- Simmer setting is perfect for gentle melting or keeping cooked food warm
- Power management system provides a boost of superior power for faster boiling
- Element lights indicate hot surfaces and active elements
- Sensor turns off element if cookware is not detected; pause function
- Two timer functions – cooking element and stand alone

## ELEMENT CAPACITY

### ▪ 30"W. Model

- 1 - 9" 3,700 watt element
- 2 - 8" 3,000 watt element
- 1 - 7" 2,200 watt element

### ▪ 36"W. Model

- 1 - 11" 5,500 watt element
- 2 - 8" 3,000 watt element
- 2 - 7" 2,200 watt element

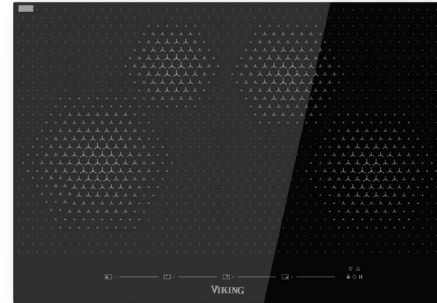

**MVIC63014BBG**

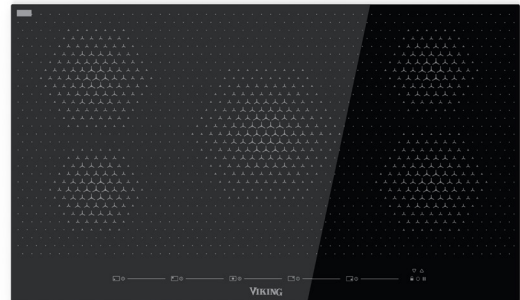

**MVIC63615BBG**

## WARRANTY

- 2-year full – complete product
- 90-day full – cosmetic parts such as glass, painted items and decorative items
- 5-year limited – induction element components



**NEW RVL BUILT-IN INDUCTION COOKTOPS**

**30/36" W MVIC**

Model	MVIC63014B	MVIC63615B
Overall Width	30" (76.2 cm)	36" (91.4 cm)
Overall Height from Bottom	To top of cooking surface: 2-1/4" (5.7 cm) To bottom edge of frame: 2" (5.1 cm)	
Overall Depth from Rear	21" (53.3 cm)	
Cutout Width	28-1/2" (72.4 cm) minimum to 29" (73.7 cm) maximum	34-1/2" (87.6 cm) minimum to 35" (88.9 cm) maximum
Cutout Depth	19-1/2" (49.5 cm) minimum to 20" (50.8 cm) maximum	
Electrical Requirements	240 VAC; 60Hz; factory-installed 4 ft. (121.9 cm) fl exible steel conduit 3-wire conduit with a No. 10 ground wire; located on the right rear corner of unit	
Max. Amp Usage	240V—32.2 amps (7.7 kw)	240V—48.3 amps (11.6 kw)
Surface Element Rating	(2) 1850W / 3000W boost (1) 2300W / 3700W boost (1) 1400W / 2200W boost	(2) 1850W / 3000W boost (2) 1400W / 2200W boost (1) 3000W / 5500W boost
Approximate Shipping Weight	52 lb. (23.6 kg)	56 lb. (24.4 kg)

Please do not prepare installation from brochure data only. See installation instructions for important clearance/installation information.

**30"W. COOKTOP**

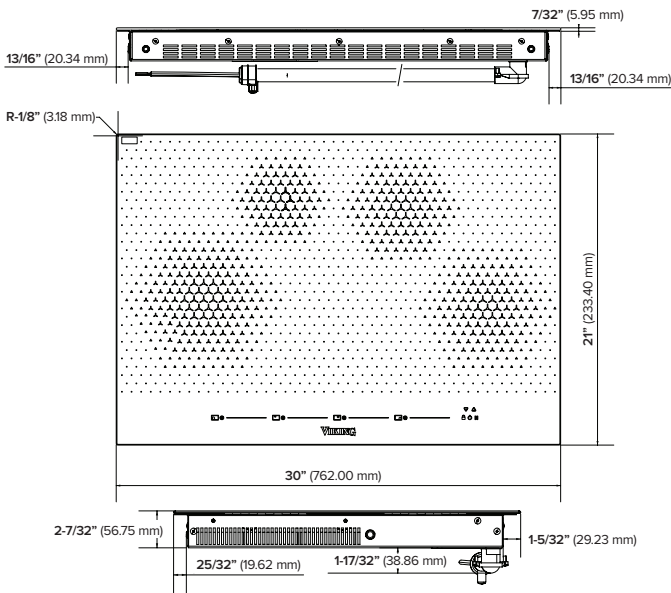

**36"W. COOKTOP**

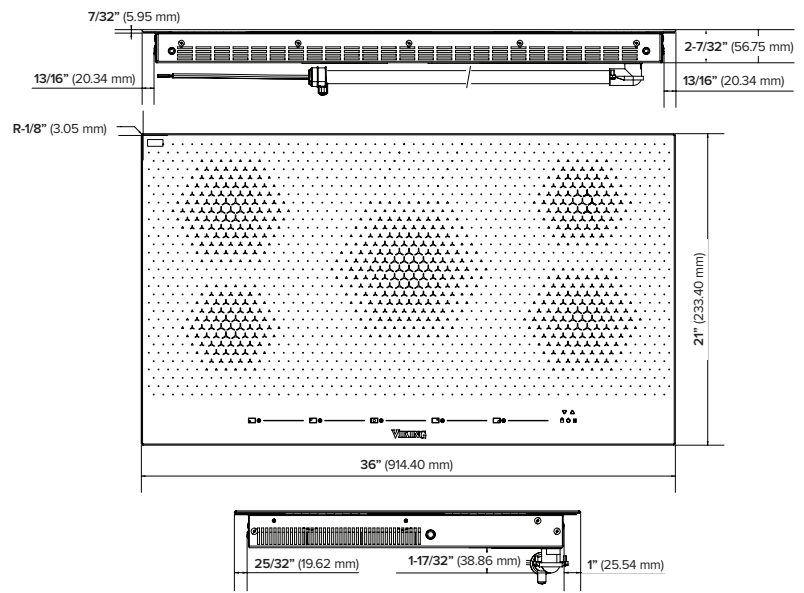

**STANDARD INSTALLATION**

	30"W. Model	36"W. Model
A	28-1/2" (72.4 cm) min. to 29" (73.7 cm) max.	34-1/2" (87.6 cm) min. to 35" (88.9 cm) max.
B	19-1/2" (49.5 cm) minimum to 20" (50.8 cm) maximum	

**FLUSH MOUNT INSTALLATION**

	30"W. Model	36"W. Model
A	28-1/8" (73.9 cm)	35-1/8" (89.2 cm)
B	20-1/8" (51.1 cm)	
C	30-1/8" (76.5 cm)	36-1/8" (91.4 cm)
D	21-1/8" (53.7 cm)	

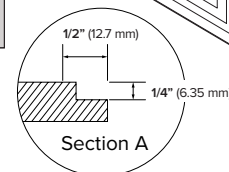
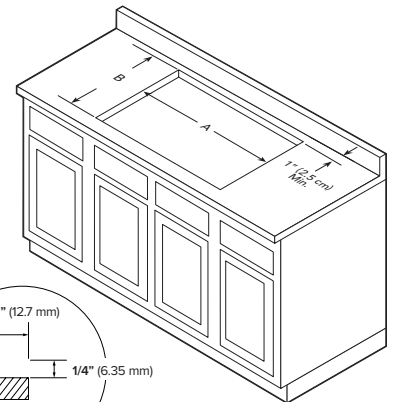
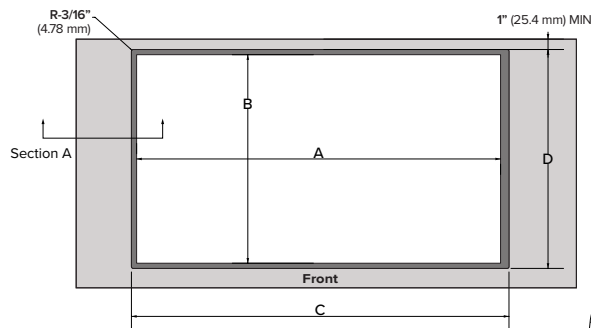

Note: Based on 24" deep cabinet with 3/4" backsplash.

FIND YOUR LOCAL DEALER AT [VIKINGRANGE.COM](http://VIKINGRANGE.COM)  
FOR PRODUCT INFORMATION, CALL 1-888-845-4641 OR VISIT OUR WEBSITE

VIKING RANGE, LLC 111 FRONT STREET GREENWOOD, MS 38930 USA  
© 2020 VIKING RANGE, LLC. ALL RIGHTS RESERVED.

