

# RBMU36RX



Product family	Refrigerator
Installation	Built-in
Category	Bottom mount
Built-in niche	>200
Reference width	Higher than 80
Reference height	Higher than 200
No-frost system	Total
Cooling type	No-frost
Defrost	Automatic
Hinge	Door-to-door
Hinge position	Right
EAN code	8017709332693



## Aesthetic

Aesthetics	Universal	Door shelf profile color	Silver
Color	Stainless steel	Drawers profile color	Silver
Material	Steel	Glass shelf profile color	Silver
Door stainless steel type	Normal	Display	TFT
Handle	Fixed	Display position	Internal
Logo color	Stainless steel	Water filter	Yes
Side material	Steel	Available colors	Steel
Logo	Applied		

## Refrigerator compartment features



No. of adjustable shelves	3	Type of crisper cover	Glass
Number of fruit and vegetables drawers	1	Low temperature compartment	Yes
Type of adjustable shelves	Glass	Refrigerator lighting	Yes
Crisper drawer type	Sliding crisper	Refrigerator lighting	LED
Crisper cover	Yes		

## Refrigerator Inner Door

Number of adjustable door shelves	3	Adjustable door bins with wire support	Yes
-----------------------------------	---	--	-----

## Other Refrigerator features



MultiFlow Yes

## Freezer features

Number of drawers 1

## Other Freezer features

Ice maker Automatic Ice-tray shelf Yes

## Other technical features

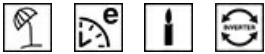

Display functions	Holiday, Fast-cooling, ECO, Temperature alarm, Showroom mode, Sabbath
Water network connection	Yes
Power-on light	Yes
Temperature alarm	Yes
Door open alarm	Yes
Temperature setting type	Electronic
No. of compressors	2
Refrigerant gas type	R600a
Compressor type	Inverter
Refrigerant quantity	3.8 oz
Foam agent	HFO

## Performance / Energy Label NEW

Annual energy consumption	580 KWh/year	Refrigerator compartment	15.01 cu. ft.
Total volume	19.63 cu. ft.	Total volume	19.63 cu. ft.
Freezer volume	4.63 cu. ft.		

## Electrical Connection

Plug	(B) USA 120V	Frequency (Hz)	60 Hz
Current	3,5 A	Power cord length	78 3/4 "
Voltage (V)	115 V		

## Also available

Installation kit code



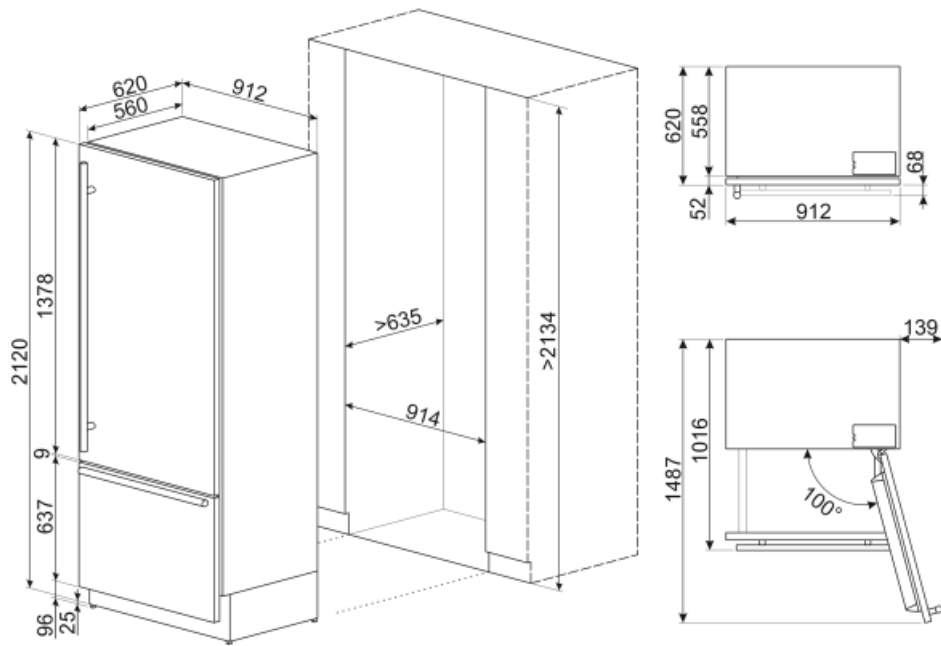



RSFZLK



---

## Symbols glossary (TT)

---

- |  |   |   |  |
|--|---|---|--|
|  | The automatic defrost system works by automatically defrosting at regular intervals eliminating the need to defrost altogether.   |  | Economical mode: Analyzes fridge functioning during the activation and optimizes the operating cycle in order to reduce power consumption. |
|  | Power saving mode: The power saving mode allows you to disable the refrigerator and keep the freezer working.   |  | LED interior lighting: is a more energy efficient and long lasting way of illuminating the interior of the appliance.                      |
|  | Inverter technology: The evolution of Smeg's driers towards more intelligent and environmentally sustainable models has led to the choice of using Inverter technology with heat pumps, which reduces significantly energy consumption. |  | Air plus: keeps food fresher for longer.   |
|  | Sabbath: This function allows you to cook food during the Sabbath, the Holiday of rest in the Jewish religion, respecting the precepts. The oven works  |   |  |