

PRODUCT DIMENSIONS

SIDE VIEW

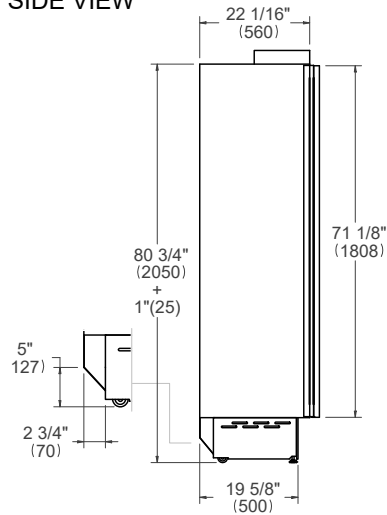

FRONT VIEW

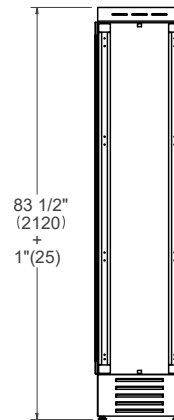

TOP VIEW

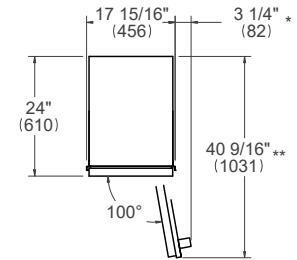

* Maximum Overall Handle Dimension
** Width of 3/4" (19mm) Door Panel

CUTOUT DIMENSIONS

SIDE VIEW

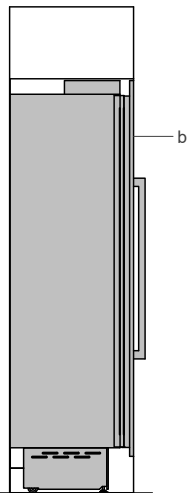

FRONT VIEW

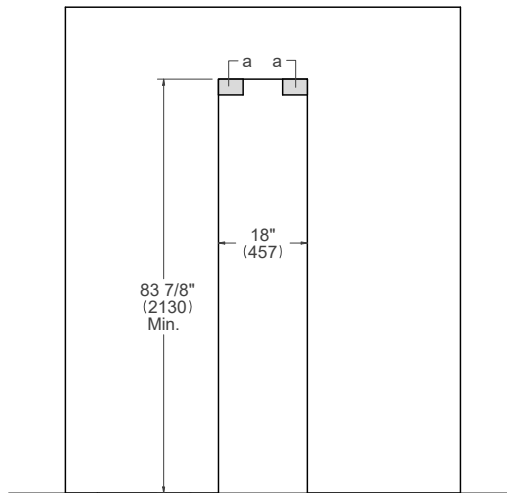

TOP VIEW

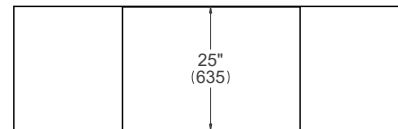

- (a) Area to be left clear for the anti-tipping brackets 3 1/2x5" (82x127mm)
- (b) Panel dimensions available on Built-in Food Preservation Design Guide or Installation Manual

ELECTRICAL & WATER CONNECTION

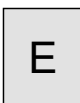

A properly-grounded, horizontally-mounted electrical receptacle should be installed according to this drawing

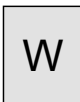

To connect to the water supply system, a 1/4" NPT waterline with accessible shut-off valve must be supplied.

Connection(s) placement within the opening may require additional cabinet depth.

TOP VIEW

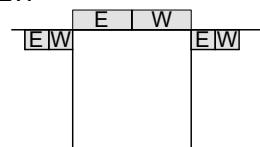

FRONT VIEW



INSTALLATION REQUIREMENTS

If the appliance(s) is not connected through the side profile trims to secured cabinetry anti-tip brackets must be installed.

A separate circuit breaker servicing only this appliance is recommended. For installation of multiple products in combination, refer to the Built-in Food Preservation Design Guide. Dimensions in parentheses are millimeters unless otherwise specified.