

# REF24WCPIXL/23

24" BUILT-IN WINE CELLAR COLUMN LEFT SWING DOOR, STAINLESS STEEL



Preserve the character of your favorite wine and champagne as a result of zone dedicated evaporators, cork protecting humidity controls, UV light-shielding glass window and vibration-free variable speed compressor.

Enjoy ample and flexible storage of all type of bottles thanks to Bertazzoni's columns design featuring the most usable interior depth in the category.

Ensure the utmost in bottle storage with a precious wood shelf design anchored by a premium telescopic smooth motion glide system.

Access temperature, humidity and interior lighting settings for each zone through the intuitive digital touch control interface.

Maintain the correct temperature in each zone when opening the door for reloading, thanks to the unique lateral side-to-side airflow circulation.

Truly flush front alignment with the adjacent cabinets and minimal clearance with the exclusive "Lift & Swing" door hinge.

Create single, double, triple and more columns configurations to best suit your kitchen layout.

Choose Professional, Master or Heritage Series handle kit to match your other Bertazzoni kitchen appliances. Purchase Décor Sets in Gold (DS2HERTGO), Polished Copper (DS2HERTPC) or Satin Black (DS2HERTSB) to personalize your Heritage Series handles (6 handle finials per set), or in Satin Gold (DSMASHSG) or Satin Black (DSMASHSB) to customize your Master Series handles (2 handle finials per set).

2 years parts & labor warranty and 5 years labor warranty for the entire sealed system.

## PRODUCT FEATURES

Size	H: 84" W: 24" D: 25"
Refrigerator type	Built-in wine cellar column
Door finish	Stainless steel with glass
Interior finish	White aluminum
User interface	Internal digital TFT touch and scroll interface
Lighting	LED lights interior illumination
Wine racks	12 wooden shelves
Cooling system	Two temperature zones
Modes	Humidity control, Sabbath mode
Open door alarm	Yes

## INTERIOR CAPACITY

Bottle capacity	80 bottles
-----------------	------------

## TECHNICAL SPECIFICATIONS

Electrical supply	115 V 60 HZ - 152 W 1.4 Amp
Power connection	NEMA 5-15P with 79" power cord
Energy consumption	475.0 kWh/yr
Certification	ETL
Warranty	2 years parts & labor Sealed system: 5 years labor
Packaging dimensions and weight	W 31 1/2" H 89" D 31 1/2" 357.0 lbs

## OPTIONAL ACCESSORIES

PROHKCOL	Handle kit - Professional series
MASHKCOL	Handle kit - Master series
HERHKCOL	Handle kit - Heritage series
901561	48" Bridge toekick
901560	42" Bridge toekick

# REF24WCPIXL/23

24" BUILT-IN WINE CELLAR COLUMN LEFT SWING DOOR, STAINLESS STEEL



## PRODUCT DIMENSIONS

SIDE VIEW

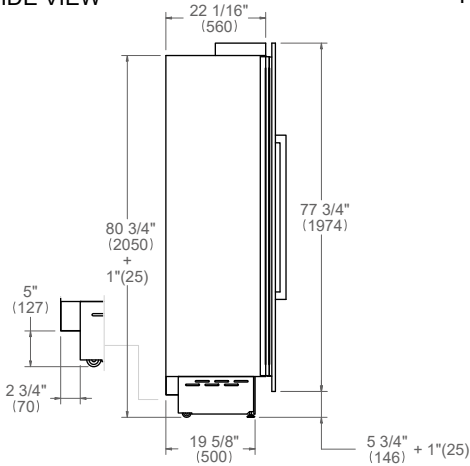

FRONT VIEW

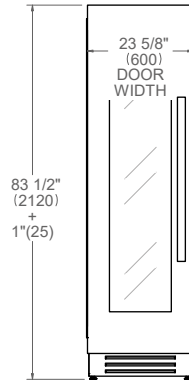

TOP VIEW

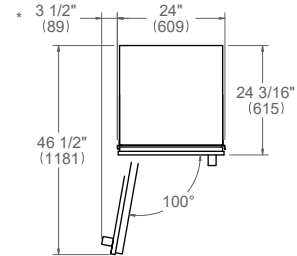

\* Maximum Overall Handle Dimension

## CUTOUT DIMENSIONS

SIDE VIEW

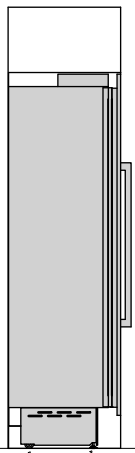

FRONT VIEW

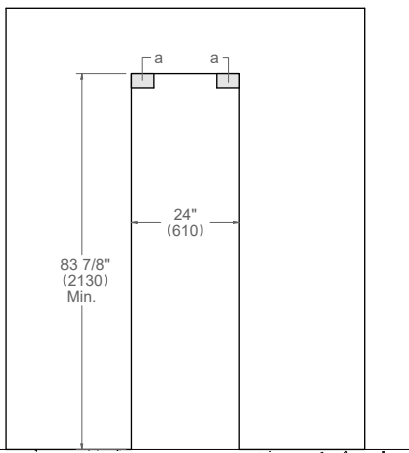

TOP VIEW

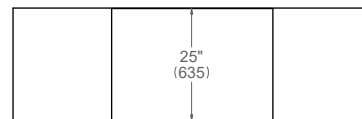

(a) Area to be left clear for the anti-tipping brackets  
3"1/2x5" (82x127mm)

## ELECTRICAL CONNECTION



A properly-grounded, horizontally-mounted electrical receptacle should be installed according to this drawing

Connection(s) placement within the opening may require additional cabinet depth.

TOP VIEW

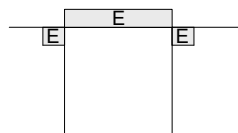

FRONT VIEW

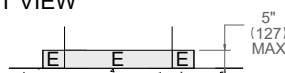

## INSTALLATION REQUIREMENTS

If the appliance(s) is not connected through the side profile trims to secured cabinetry anti-tip brackets must be installed.

A separate circuit breaker servicing only this appliance is recommended.  
For installation of multiple products in combination, refer to the Built-in Food Preservation Design Guide.  
Dimensions in parentheses are millimeters unless otherwise specified.

A separate circuit breaker servicing only this appliance is recommended.  
For installation of multiple products in combination, refer to the Built-in Food Preservation Design Guide at [us.bertazzoni.com](http://us.bertazzoni.com) or [ca.bertazzoni.com](http://ca.bertazzoni.com)

**Disclaimer:** while every effort has been made to ensure the accuracy of the information contained in this document, Fratelli Bertazzoni reserves the right to change it at any time without notice. For detailed installation instructions, consult the installation manual. Fratelli Bertazzoni, Bertazzoni and the winged wheel brand icon are registered trademarks of Bertazzoni Spa.