

RSDU30RX



Product family	Refrigerator
Installation	Built-in
Category	Single door
Built-in niche	>200
Reference width	70 - 80
Reference height	Higher than 200
No-frost system	Yes
Cooling type	Total no-frost - Dual-flow cooling system
Defrost	Automatic
Hinge	Door-to-door
Hinge position	Right
EAN code	8017709332723



Aesthetic

Aesthetics	Universal	Side material	Steel
Color	Stainless steel	Logo	Applied
Material	Steel	Door shelf profile color	Silver
Door stainless steel type	Normal	Drawers profile color	Silver
Handle	External	Glass shelf profile color	Silver
Handle	Fixed	Display	TFT
Handle color	Stainless steel	Display position	Internal
Logo color	Stainless steel	Water filter	Yes

Refrigerator compartment features



No. of adjustable shelves	3	Type of crisper cover	Glass
Number of fruit and vegetables drawers	3	Low temperature compartment	Yes
Type of adjustable shelves	Glass	Refrigerator lighting	Yes
Crisper drawer type	Sliding crisper	Refrigerator lighting	LED
Crisper cover	Yes		

Refrigerator Inner Door

Number of adjustable door shelves	3	Adjustable door bins with wire support	Yes
--	---	---	-----

Other Refrigerator features



MultiFlow

Yes

Other technical features



Display functions

Holiday, Fast-cooling, Temperature alarm, Showroom mode, Sabbath

Door open alarm

Yes

Temperature Alarm

Yes

Antibacterial gasket

Yes

Temperature setting type

Electronic

No. of compressors

1

Refrigerant gas type

R600a

Compressor type

Inverter

Refrigerant quantity

3.0 oz

Foam agent

Cyclopentane

Performance / Energy Label NEW

Annual energy consumption

343 KWh/year

Total volume

17.41 cu. ft.

Electrical Connection

Plug

(B) USA 120V

Frequency (Hz)

60 Hz

Current

2.5 A

Power cord length





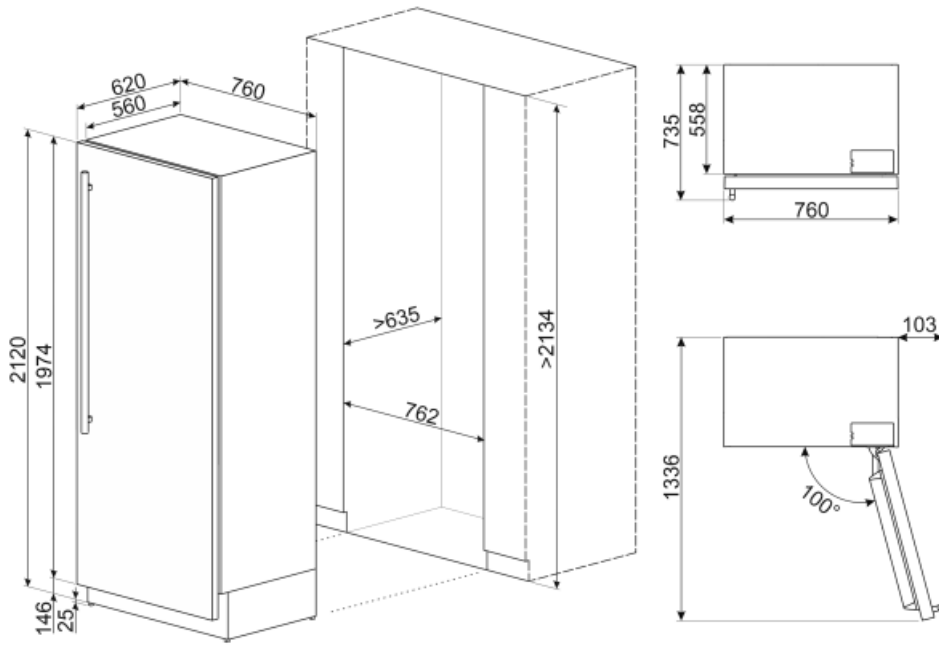

78 3/4 "

Voltage (V)

115 V



Symbols glossary (TT)

- | | | | |
|--|---|---|---|
|  | The automatic defrost system works by automatically defrosting at regular intervals eliminating the need to defrost altogether. |  | Antibacterial treatment: antibacterial treatment to ensure better hygiene |
|  | Power saving mode: The power saving mode allows you to disable the refrigerator and keep the freezer working. |  | LED interior lighting: is a more energy efficient and long lasting way of illuminating the interior of the appliance. |
|  | Inverter technology: The evolution of Smeg's driers towards more intelligent and environmentally sustainable models has led to the choice of using Inverter technology with heat pumps, which reduces significantly energy consumption. |  | Air plus: keeps food fresher for longer. |
|  | Sabbath: This function allows you to cook food during the Sabbath, the Holiday of rest in the Jewish religion, respecting the precepts. The oven works | | |