

RSG48E/RSG48EB



INSTALLATION INSTRUCTIONS

INSTALLATION INSTRUCTIONS MANUAL

RSG48E/RSG48EB RSG48ELP/RSG48EBLP

THOR
K I T C H E N[®]

TABLE OF CONTENTS

1.SAFETY AND WARNINGS	1
SAFETY SYMBOLS.....	3
ELECTRICAL SHOCK HAZARD.....	4
TIPPING HAZARD.....	4
EXPLOSION HAZARD.....	5
FIRE HAZARD.....	5
POISONING HAZARD.....	6
HOT SURFACE HAZARD.....	6
OTHER SAFETY TIPS.....	6
2.IMENSIONS AND CLEARANCES	9
TOP HOOD AND CABINET SPECIFICATIONS.....	10
3.ELECTRIC POWER SUPPLY REQUIREMENTS	11
4.INSTALL KNOBS	14
Oven Knob Installation.....	14
5.INSTALL HANDLES	16
Oven Handle Installation.....	16
6.INSTALL SPACER	18
Rubber Pad Installation on Back Panel.....	18

SAFETY AND WARNINGS

WARNINGS

These are the most critical warnings summarized below.



- If the instructions in this manual are not followed exactly, a fire or explosion may result, causing property damage, personal injury or death.
- Do not store or use gasoline or other flammable substances and liquids near this or other appliance,
- Never use this appliance as a space heater to warm a room.
- Installation of this appliance must be done by a qualified, service agency or gas supplier.

What to do if you smell gas

- Do not light any appliance
- Do not touch an electrical switch
- Immediately call the gas supplier from a neighbor's phone
- Open a window and leave the area
- Follow the gas supplier's instructions
- If you cannot reach the gas supplier, call the fire department



SAFETY AND WARNINGS

BEFORE YOU START

- Make sure that the anti-tip of the range has been properly installed.
- Find the model and serial numbers on the CSA label in the bottom right-hand corner of the backboard. Note these numbers down for future reference in the space provided in section 'Warranty and service'.
- Read this guide, taking special note of the 'Safety and warnings' section.
- Remove all the packaging from the oven(s) and cooktop. Recycle items that you can. If any adhesive residue is left on surfaces, remove this using dish washing liquid on a soft cloth. Do not use any harsh or abrasive cleaners.
- Make sure you follow the instructions under 'First use' before using your range for cooking.
- To reduce the risk of fire, electrical shock, injury to persons, or damage when using the appliance, follow the important safety instructions listed below:

SAFETY & WARNINGS

SAFETY SYMBOLS

SYMBOL	DEFINITION
	<p>This will alert you to potential personal or property safety hazards. Obey all safety rules to avoid any property damage, personal injury or death</p>
	<p>WARNING indicates a potentially hazardous situation, which, if not avoided, could result in serious injury or death</p>
	<p>CAUTION indicates a moderate hazardous situation, which, if not avoided, could result in minor or moderate injury</p>
<p>CAUTION</p>	<p>CAUTION - when used without the safety alert symbol, indicates a potentially hazardous situation, which, if not avoided, could result in property damage</p>
<p>IMPORTANT</p>	<p>IMPORTANT used for installation, operation and maintenance information that are not related to safety.</p>

SAFETY AND WARNINGS

ELECTRICAL SHOCK HAZARD

- ✓ Before removing a faulty oven light bulb, make sure you turn OFF the power to the range at the main fuse or circuit breaker panel. If you don't know how to do this, contact an electrician.
- ✓ Do not remove the kick panel or the back panel. Due to electrical wires behind it, both panels should only be removed by a qualified technician.
- ✓ This appliance is equipped with a three-prong grounding plug for your protection against shock hazard and should be plugged directly into a properly grounded power outlet. Do not under any circumstances cut or remove the grounding prong from this plug.

Failure to follow this advice may result in death or electrical shock.

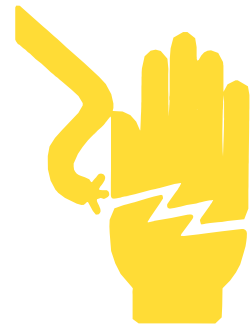

TIPPING HAZARD

- ✓ All ranges can tip and cause injuries to adults and children. To prevent tipping, install the anti-tip device supplied with your range. Follow all installation instructions.
- ✓ Even after the safety device is installed, do not step, lean or sit on the oven door or place any heavy objects on it. Doing so may result in personal injury.
- ✓ Make sure anti-tip device is installed as follows:
 1. Slide the range forward.
 2. Install the anti-tip device as described in the instruction sheet
 3. Safely tilt the front section of the range and slide the range slowly back against the wall.
 4. The rear pins should slide under the bracket.

Do not use the appliance until it has been secured.
Failure to follow this advice may result in serious injury.



SAFETY & WARNINGS

EXPLOSION HAZARD

- ✓ If you smell gas, do not use the appliance. Open a window or door to let the gas escape, then follow the instructions on the inside front cover of this manual.
- ✓ Do not use water on grease fires. A violent steam explosion may result.
- ✓ Turn all burners off, then smother fire or flame with a dry chemical or foam-type extinguisher. Do not try to smother with flammable blankets.
- ✓ Do not heat unopened food containers such as cans. Build-up of pressure may cause container to burst and result in injury.

Failure to follow this advice may result in injury or death

FIRE HAZARD

- ✓ **Never use your appliance as a space heater.** Persons could be injured or a fire could start.
- ✓ **Keep the area around the appliance free from combustible materials** (e.g. wall coverings, curtains, drapes), gasoline and other flammable vapors and liquids.
- ✓ **Clean the stove and burners regularly.**
Do not let cooking grease or other flammable materials accumulate on the surfaces or near the appliance.
- ✓ **Do not hang any articles (e.g. dish towels) off the oven handle.** Some fabrics may ignite or melt from the heat.
- ✓ **Never leave the cooktop burners unattended when in use.** Boil over causes smoking and greasy spillovers that may ignite.
- ✓ **Never spray an aerosol cleaner on or around the appliance while burners are lit.**
Be sure all the controls are turned off and the appliance is cool. The aerosol gas and chemicals in such cleaners could, in the presence of heat, ignite or cause metal parts to corrode.
- ✓ **Do not store flammables near cooktop.**
Flammable materials should not be stored in an oven or near the cooktop. An accident could cause a serious fire.



SAFETY AND WARNINGS

POISONING HAZARD

- ✓ **Never cover any slots, holes or passages in the oven bottom or cover an entire rack or the oven floor with materials such as aluminum foil.** Doing so blocks airflow through the oven and may cause carbon monoxide poisoning. Aluminum foil linings may also trap heat, causing a fire hazard.
- ✓ **Clean the appliance with caution.** If a wet sponge or cloth is used to wipe spills on a hot cooking area, be careful to avoid steam burn. Some cleaners can produce noxious fumes if applied to a hot surface. Follow the directions of the cleaner manufacturer.
- ✓ **Never use this appliance as a space heater to heat or warm the room.** Doing so may result in carbon monoxide poisoning and overheating of the appliance. Failure to follow this advice may result in poisoning or death.



HOT SURFACE HAZARD

Accessible parts may become hot during use.

- ✓ **Do not touch burners, areas near burners, the grill, griddle, grease drippans, heating elements or interior surfaces of oven.** These may be hot enough to cause burns even though they are dark in color. During and after use, do not touch, or let clothing or other flammable materials contact these parts and surfaces until they have had sufficient time to cool. Other parts and surfaces of the appliance may become hot enough to cause burns - among these areas are the grates, back trim and oven vents at the back of the cooktop, front edge, surfaces adjacent to the cooktop, and the oven door.
- ✓ **Use only dry potholders.** Moist or damp potholders on hot surfaces may result in burns from steam. Do not let potholder touch hot heating elements. Do not use a towel or other bulky cloth.
- ✓ **Let hot grease cool** before attempting to handle it. Failure to follow this advice could result in burns and scalds.



OTHER SAFETY TIPS

Read instructions before use

Read all the instructions before using the appliance. Use the appliance only for its intended purpose as described in these instructions.

Install the stove properly

Be sure your stove is properly installed and grounded by a qualified technician

SAFETY AND WARNINGS

Do not install or operate stove if damaged.

Do not operate the appliance if it is damaged or not working properly. If you received a damaged product, contact your dealer or installer immediately.

Know how to turn off power in emergency.

Be sure to have the installer show you where and how to turn off the power supply to the range (i.e. location of the main fuse or circuit breaker panel) and where and how to turn off the gas supply to the range in an emergency.

Do not leave children alone near stove.

Children should not be left alone or unattended in the area where the appliance is in use. They should never be allowed to play with the appliance or to sit or stand on any part of the appliance.

Don't wear loose clothing that could catch fire.

Loose-fitting or hanging garments should never be worn while using the appliance.

Do not repair or replace parts yourself (unless recommended in the manual). All other servicing should be referred to a qualified technician. Technicians must disconnect the appliance from the power supply before any servicing.

Be careful opening the oven door. Use care when opening the oven door by allowing warm air or steam escape before removing or replacing food

Keep oven vent ducts unobstructed.

Do not touch hot oven shelves. Protect your hands from burning by making sure the oven is cool before sliding oven shelves into oven. If a shelf must be removed while the oven is hot, do not let oven mitts or potholder contact the base of the oven or hot heating elements in the oven.

Do not use the range as a space heater.

Protect oven gasket. Do not clean the oven gasket or use any oven cleaning products on it. It is essential for a good seal, which ensures that the oven operates efficiently. Care should be taken not to rub, damage or move it.

Protect glass oven doors. Do not use harsh/ abrasive cleaners, scourers or sharp metal scrapers to clean the oven door glass since they scratch the surface, which may result in the glass shattering.

Never step on oven door or place a heavy object (like a turkey) on it.

Check for gas leaks. When the appliance is installed, check for gas leaks according to the instructions before use.

Ventilation hood is mandatory. This appliance should not be operated without a properly sized and operational ventilation hood.

Use the proper gas conversion kit. This stove only uses natural gas. For LP gas, please use a conversion kit (**not included with the stove**). Please have a certified technician install the unit and kit. If planning to resell unit, please indicate whether it is natural gas or has an LP kit installed.

Do not reach for items over the stove when it is lit. Be careful when reaching for items stored in cabinets above the appliance.

Read all instructions before using the product to ensure proper and safe operation. Install or locate the product only in accordance with the provided Installation Instructions.

Do not attempt to adjust, repair, service or replace any part of your appliance unless it is specifically recommended in this guide.

SAFETY AND WARNINGS

Do not leave children unattended in the area where the range is in use. Never allow children to sit or stand on any part of the range. Do not let children play with the range.

All servicing should be referred to a qualified technician. Have the technician show you the location of the gas shut off valve and how to shut it off in an emergency

Always disconnect power to appliance before any type of servicing.

Do not use abrasive or caustic cleaners or detergents on this appliance. They may cause permanent damage to the surface.

When cooking, set the burner controls so that the flame heats only the bottom of the utensil and does not overlap at the sides of the utensil.

Utensils (pots and pans) that conduct heat slowly, e.g. glass pots, should be used in conjunction with burner flames at a low or medium setting.

Turn off all controls and wait for appliance parts to cool down before touching them. Do not touch the burner grates or surrounding areas until cool.

Do not use water on grease fires.

Clean appliance with caution.

Always turn pot handles to the side or back of the range. Do not turn handles towards the area where they are easily burned. Handles should not extend over the adjacent burners.

Use the range only for cooking tasks as outlined in this manual. When using the range, do not touch the grates, burner caps, burner bases, or any other parts in proximity to the flame. These components may be hot enough to cause burns.

Use dry pot holders. Moist or damp pot holders on hot surfaces may result in burns from steam. Do not use a towel or other bulky cloth.

Do not heat unopened food containers. Buildup of pressure may cause the container to explode and result in injury.

During and after use, do not touch interior surfaces of the oven until cool.

Do not let potholders touch hot surface areas.

DIMENSION AND CLEARANCE

RSG48E/RSG48ELP/RSG48EB/RSG48EBLP

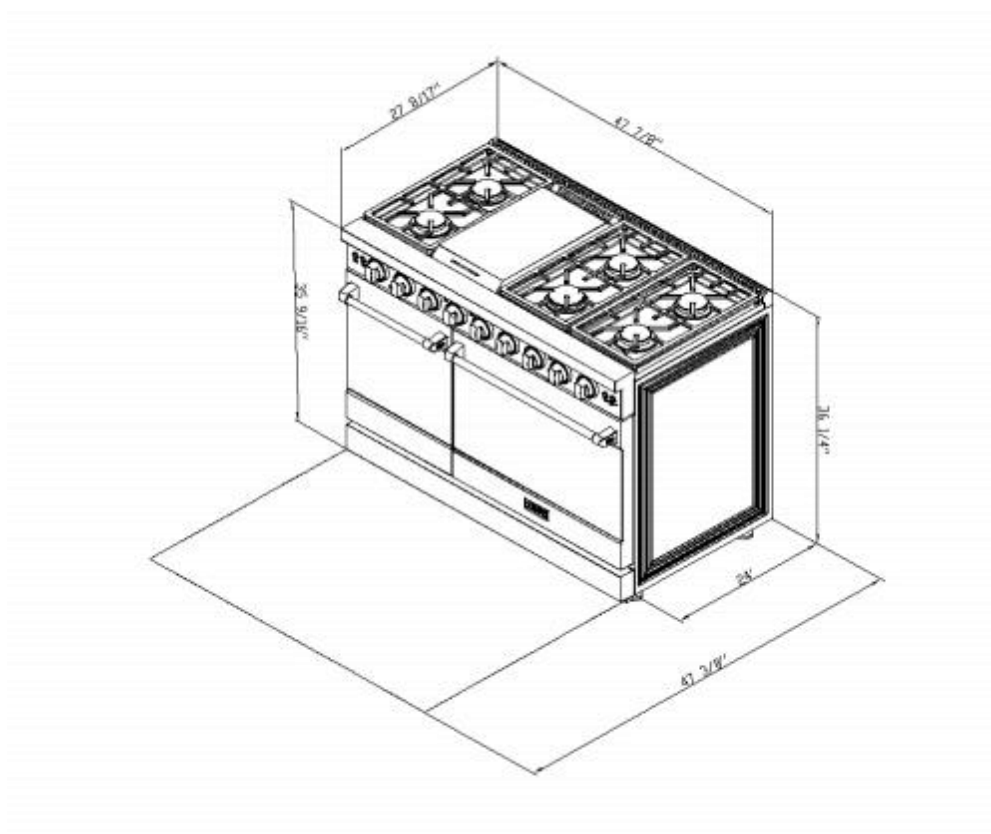

The maximum depth of cabinets installed above cooking tops be 13 in (330mm).

DIMENSION AND CLEARANCE

48" Gas Range Clearance

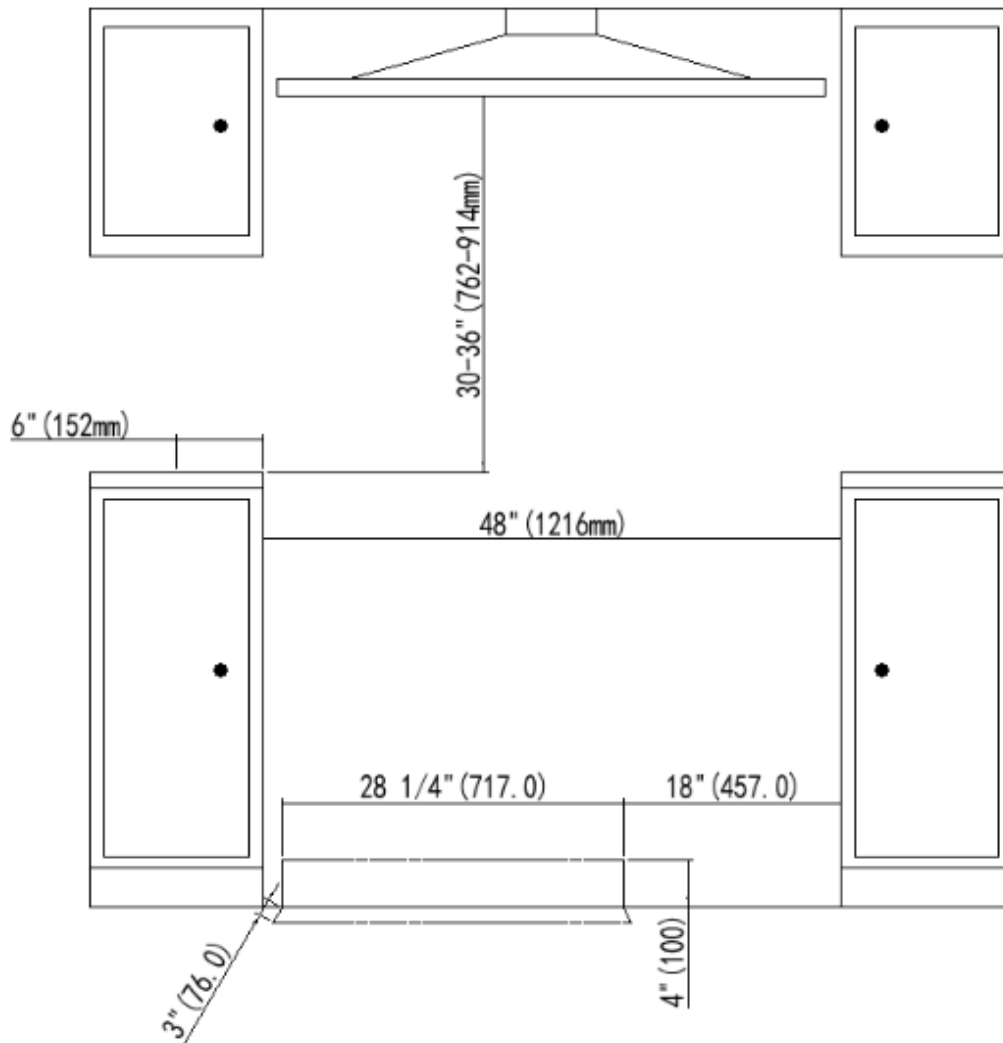

DIMENSION AND CLEARANCE

TOP HOOD AND CABINET SPECIFICATIONS

Condition	Minimum Clearance Allowed
Clearance between the top of the cooking surface and the bottom of an unprotected wood or metal cabinet for any model other than RSG48E, RSG48EB, RSG48ELP, RSG48EBLP.	35"
Clearance between the top of the cooking surface and the bottom wood or metal cabinet that is protected by no less than: <ul data-bbox="191 1058 1101 1312" style="list-style-type: none">• ¼-inch thick flame-retardant millboard covered with not less than:<ul data-bbox="289 1142 846 1312" style="list-style-type: none">• No. 28MSG sheet steel or• 0.015-inch thick stainless steel or• 0.024-inch thick aluminum or• 0.020-inch thick copper	24"

DIMENSION AND CLEARANCE

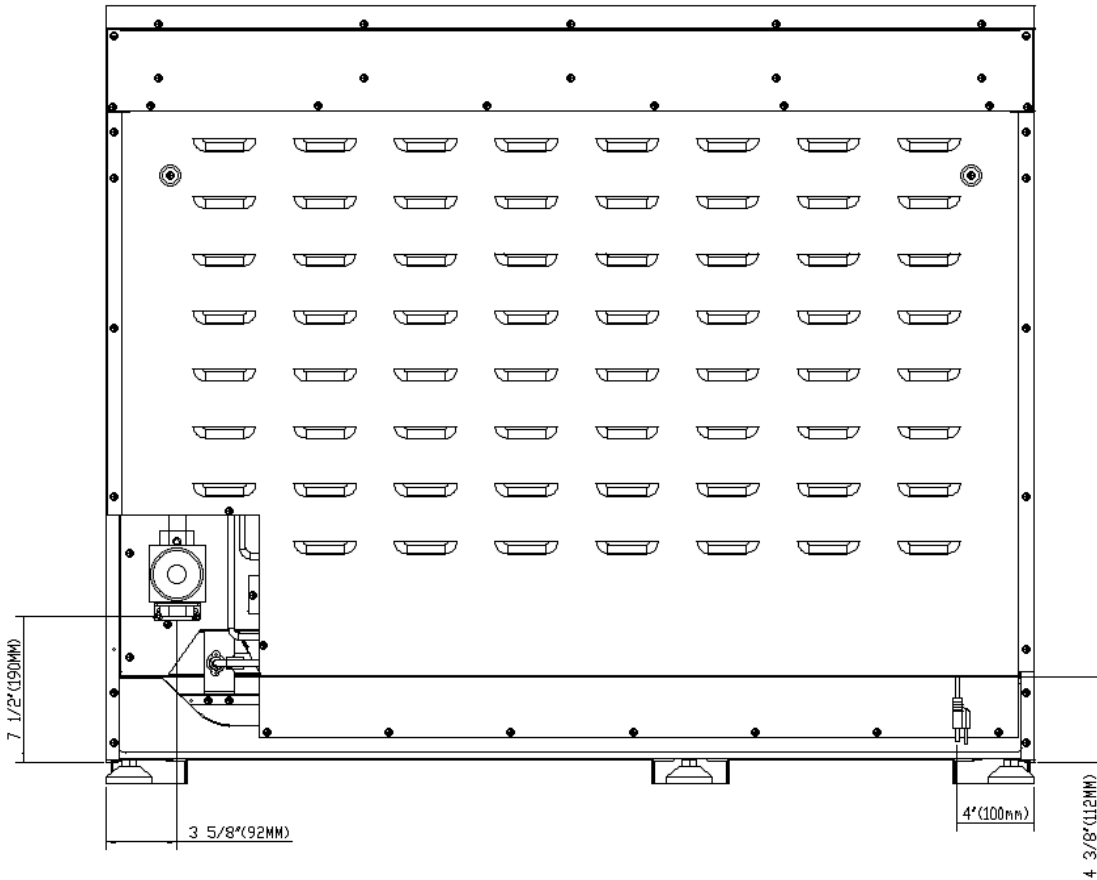

ELECTRIC POWER SUPPLY REQUIREMENTS

Your range must be electrically grounded in accordance with local codes or, in the absence of local codes, in accordance with the National Electrical Code (ANSI/NFPA 70, latest edition).

In Canada, electrical grounding must be in accordance with the current CSA C22.1 Canadian Electrical Code Part 1 and/or local codes. A copy of this standard may be obtained from: National Fire Protection Association, 1 Battery March Park, Quincy, Massachusetts 02269-9101.

The power supply must be the correct polarity. Reverse polarity will result in continuous sparking of the electrodes, even after flame ignition. If there is any doubt as to whether the power supply has the correct polarity or grounded, have it checked by a qualified electrician.

Use 120V, 60Hz, and properly grounded branch circuit protected by a 15-amp or 20-amp circuit

DIMENSION AND CLEARANCE

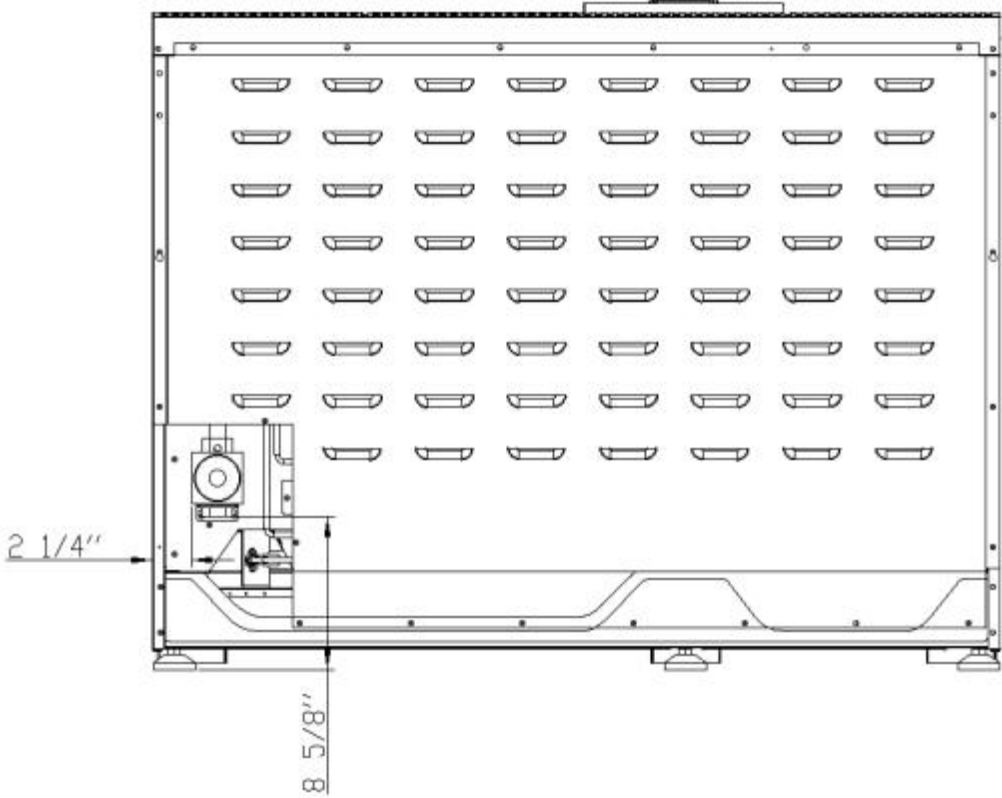

Back Layout for RSG48E (48" Gas Ranges)

INSTALL KNOBS

OVEN KNOB INSTALLATION

1. Check the sheet for the quantity of each knobs

Model #	Big Oven Thermostat Knob	Griddle / Small Oven Thermostat Knob	Surface Valve Knob
RSG48E	1	2	6
RSG48ELP	1	2	6
RSG48EB	1	2	6
RSG48EBLP	1	2	6

*For any parts damage or missing, please contact 877-288-809, or send email to Service@thorinternational.com

Find the right knob for each shaft on the range. Push the knob into fully attach the shaft and make sure there's no friction between knobs and bezels.

****|Incorrect Knob Installation will cause the damage of the oven thermostat / burner valve****

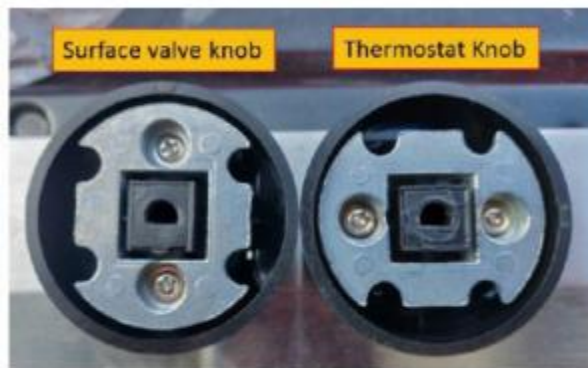

{Incorrect knob caused broken thermostat shaft}

INSTALL KNOBS

OVEN KNOB INSTALLATION

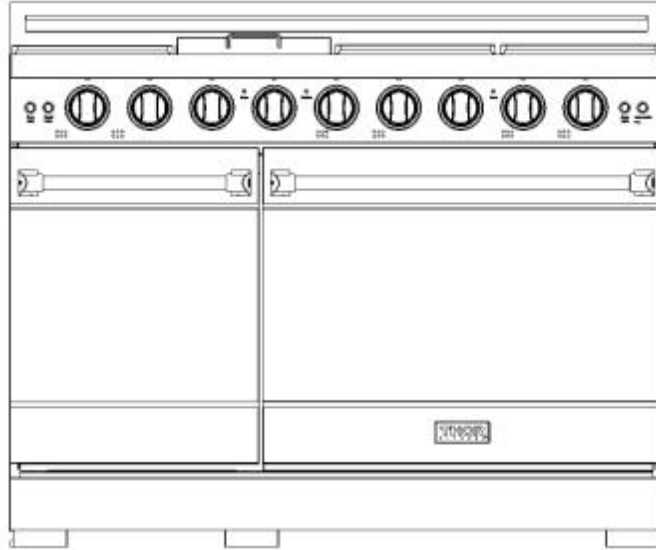

RSG48E/RSG48ELP/RSG48EB/RSG48EBLP

- ①②:Surface Valve Knob
- ③④:Griddle/Small Oven Thermostat Knob
- ⑤⑥:Surface Valve Knob
- ⑦:Big Oven Thermostat Knob
- ⑧⑨:Surface Valve Knob

YOUR RANGE MIGHT HAVE A KD HANDLE THAT NEEDS TO BE INSTALLED. PLEASE FOLLOW UP THE FOLLOWING PROCEDURES FOR THE OVEN DOOR HANDLE INSTALLATION.

Oven Handle Installation

3.1 Check your Installation Kits for Door Handles:

--4*Handle Holders

--1* Installation Wrench

--2* Handle

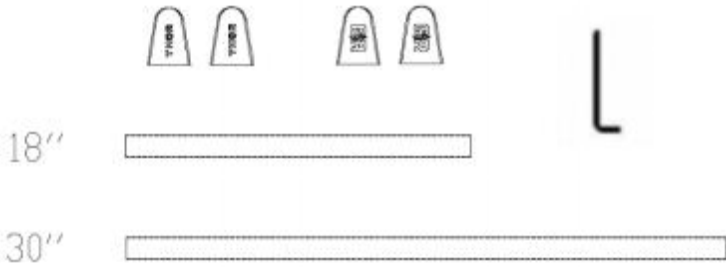

INSTALL HANDLES

Oven Handle Installation

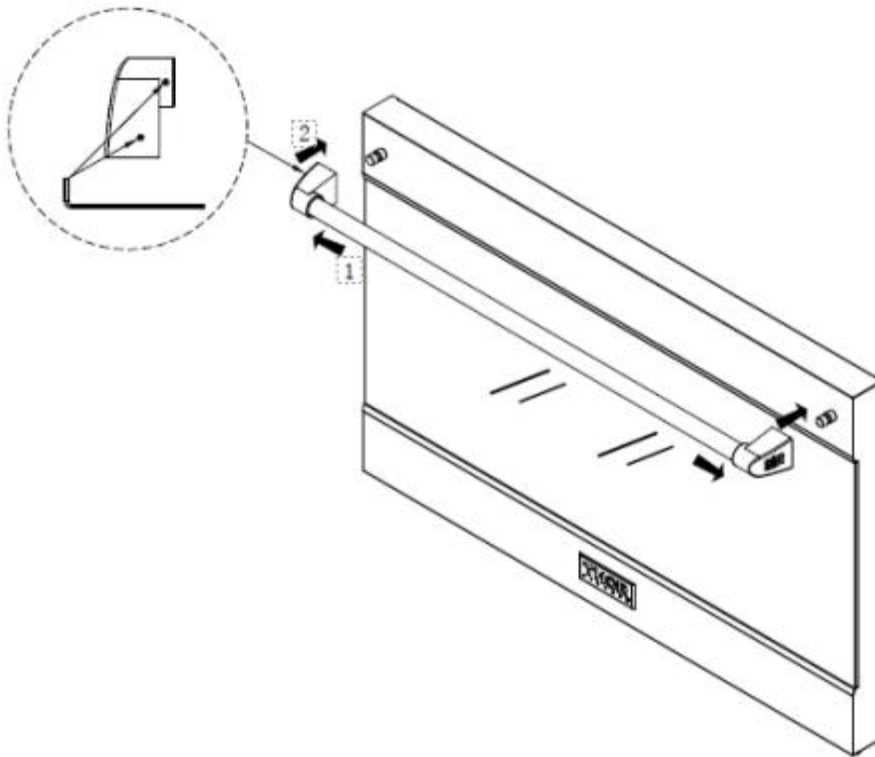

3.2 Insert the handle tube into the left and right handle seat.

3.3 Insert the handle seat into the fixed rod above the door.

3.4 Fix the handle tube and handle seat with a hex wrench.

SPACER INSTALLATION ON BACK PANEL

In order to meet the requirement for the clearance for the back of your RSG48E gas range, please install 2 pcs Rubber Pad provided in the manual package. Please find the accessories and follow the below steps:

1. check the installation kit included in the manual package

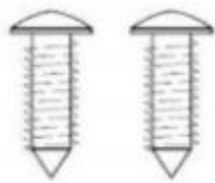

2* screws



2* rubber pad

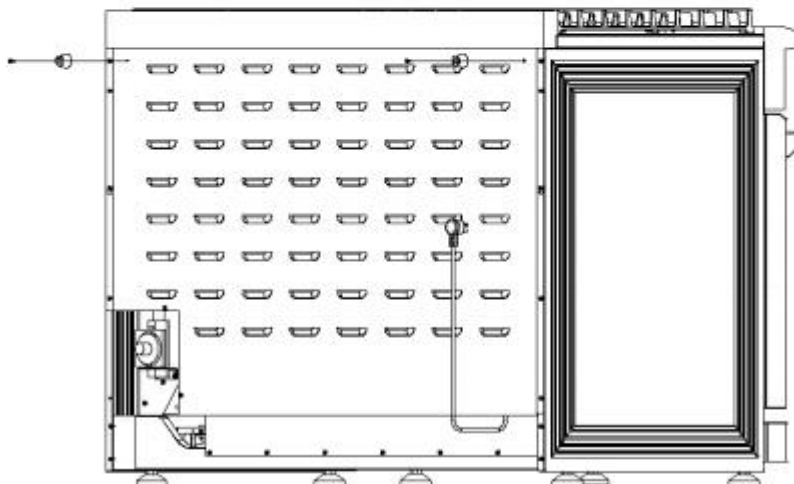

2. Install 2 pcs rubber pad shown above.



WELCOME TO THE GORDON RAMSAY COLLECTION

THOR Kitchen x Gordon Ramsay Collection is backed by a solid two-year warranty on both parts and labor. It's our commitment to quality and your peace of mind. Registering your appliance ensures top-notch service and personalized support. Your registration helps us stay informed about your appliance, enabling us to provide timely maintenance reminders, updates, and exclusive offers. This ensures your appliance maintains peak performance for years to come.

01 Scan the QR Code or visit thorkitchen.com/register-your-product.

02 Input your purchase and product information and select register.

03 That's it. You're all set. Start cookin'!

