

ZLINE

ATTAINABLE LUXURY[®]

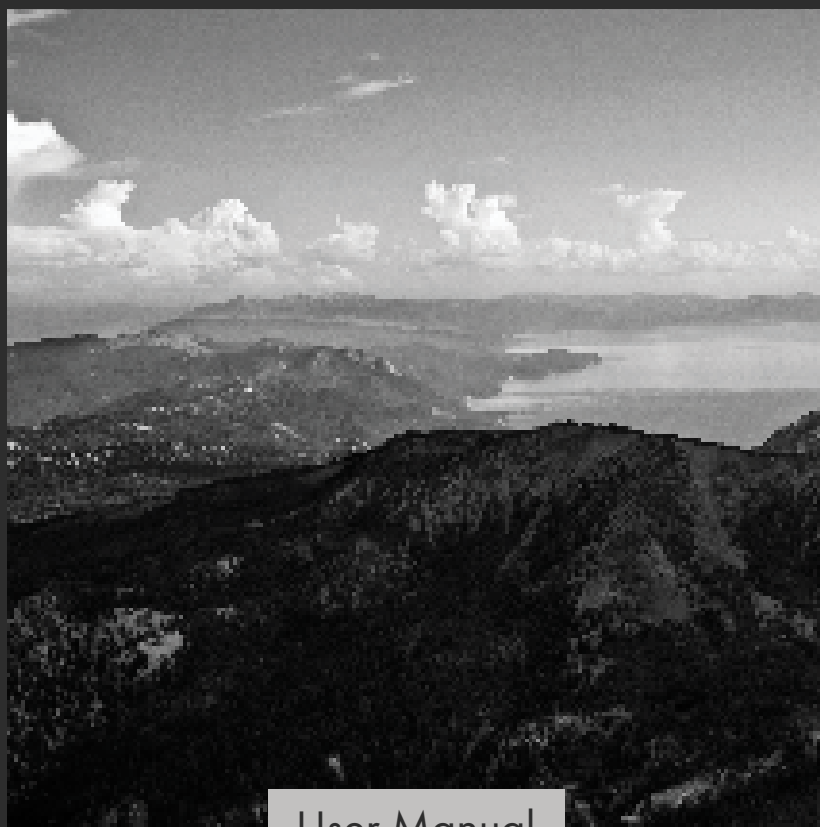

User Manual

FREESTANDING REFRIGERATION 36" RSM-W MODELS

www.zlinekitchen.com



ZLINE Kitchen and Bath provides Attainable Luxury, where the kitchen and bath of your dreams is never out of reach. Through our unique designs and unparalleled quality, we're dedicated to providing you an elevated experience in the heart of your home. With an endless selection of features and finishes, our inspiration is your reality.

ZLINE
ATTAINABLE LUXURY®

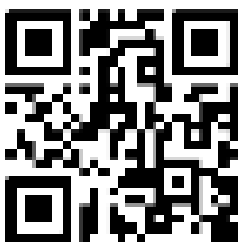

ZLINE is fueled by a passion for innovation; A relentless pursuit of bringing the highest end luxury designs and professional features into everyone's homes.

Because we continually strive to improve our products, we may change specifications and designs without prior notice.

Scan the QR code to view the most up-to-date version of the Installation Manual and User Manual.

⚠ WARNING: This product can expose you to chemicals including nickel, which is known to the State of California to cause cancer. For more information, go to www.P65Warnings.ca.gov.

TABLE OF CONTENTS

IMPORTANT SAFETY INSTRUCTIONS.....	1
General Safety	1
Food Safety	3
OPERATION	5
Product Components	5
Control Panel Overview	6
CLEANING AND MAINTENANCE.....	13
TROUBLESHOOTING.....	19
WARRANTY.....	21

IMPORTANT SAFETY INSTRUCTIONS



This warning symbol indicates a potentially hazardous situation which, if not avoided, could result in death or serious injury.



This unit's installation and user manuals contain important safety information. Failure to follow these instructions may result in death, fire, or electric shock.

GENERAL SAFETY

- This appliance is not intended for use by persons (including children) with reduced physical, sensory or mental capabilities, or lack of experience and knowledge, unless they have been given supervision or instruction concerning use of the appliance by a person responsible for their safety.
- Children should be supervised to ensure that they do not play with the appliance.
- If the electrical supply cord is damaged, it must be replaced by a professional in order to avoid electric shock hazards.
- Do not store explosive substances, such as aerosol cans with a flammable propellant, in or near this appliance.
- The appliance must be unplugged before carrying out any maintenance or if it will not be used for extended periods of time.



Keep ventilation openings in the appliance enclosure or in the built-in structure clear of obstruction.



Do not use mechanical devices or other means to accelerate the defrosting process of this unit.



Do not damage the unit's refrigerant circuit and sealed cooling system.



Do not use electrical or mechanical appliances inside the food storage compartments of the appliance.



At the end of its service life, dispose of the refrigerator according to local regulations, due to the use of flammable blowing gas and refrigerant.

IMPORTANT SAFETY INSTRUCTIONS



WARNING

When positioning the appliance at its installation location, ensure the electrical supply cord is not kinked or damaged.

- Do not use extension cords or ungrounded (2-prong) adapters when connecting this appliance to electricity.
- The refrigerator must be fully disconnected from electricity before installing accessories or when servicing the product.
- Minimum/maximum inlet water pressure is 40/100 psig (0.28/0.69 MPa).
- For refrigerator doors or drawers fitted with locks and keys, the keys should be kept out of the reach of children and not in the vicinity of the appliance in order to prevent children from being locked inside.
- Do not arbitrarily disassemble or reconstruct the refrigerator. Maintenance of the appliance must only be conducted by a professional service person.



WARNING

Risk of child entrapment. To avoid safety and suffocation risks for children or pets, before you dispose of the appliance, take off the doors and drawers and leave the shelves in place so children or pets may not climb inside.



WARNING

Do not use multiple portable electrical outlets or portable power supplies at the rear of the appliance.



WARNING

To avoid any hazards due to instability of the appliance, adjust the height according to the instructions provided in this manual.

PLACEMENT OF ITEMS

- Do not put flammable, explosive, volatile, or highly corrosive items in the refrigerator or freezer to prevent damage to the product and limit risk of fire or explosion.
- Do not place flammable items near the refrigerator to limit risk of fire or explosion.
- The refrigerator is intended for household use, such as the storage of food; it shall not be used for other purposes, such as storage of blood, drugs, biological products, etc.
- Do not store beer, soda, or other beverages contained in bottles or enclosed containers in the freezing compartment. Bottles or sealed containers may crack or explode due to freezing temperatures and can damage the refrigerator.

IMPORTANT SAFETY INSTRUCTIONS

FOOD SAFETY

- To avoid food contamination, please read the following instructions and information:
 - Opening the door for long periods of time can cause a significant increase in the temperatures inside the appliance.
 - Users should regularly clean surfaces and accessible drainage systems that come in contact with food.
 - Clean water tanks if they have not been used for 48 hours, and flush the water system connected to the water supply if water has not been drawn for 5 or more days.
 - Store raw meat and fish in suitable containers in the refrigerator so that it does not contact with or drip onto other food.
 - If the appliance is left empty for long periods of time, you should disconnect from power, defrost, clean, dry, and leave the door open to prevent mold developing within the appliance.
 - Before putting in any fresh or frozen food, the refrigerator should run for 2–3 hours or for over 4 hours in the summer when ambient temperatures are high.
- The gaps between the doors and between the doors and the refrigerator body are small. Do not put your hand in these areas. Be gentle when closing the refrigerator door to avoid food or liquids falling or spilling.
- Do not pick up food or containers with wet hands in the freezer compartment when the refrigerator is running, especially metal containers, to avoid frostbite.
- Do not place heavy objects on the top of the refrigerator. Objects may fall when closing or opening the doors, increasing risk of injury.
- Unplug the appliance from electricity in the event of power failure and when performing routine cleaning. When disconnecting from electricity, wait at least five minutes before plugging back in to prevent damages to the compressor and sealed cooling system due to successive stops and starts.

IMPORTANT SAFETY INSTRUCTIONS

ENERGY WARNINGS

- Refrigerating appliances might not operate consistently (for example: defrosting of food or warming temperatures inside the freezer compartment) when set below the cold end of the range of temperatures designed for the appliance.
- Effervescent drinks should not be stored in the freezer compartment or in low-temperature chambers or cabinets. Additionally, some products such as ice water should not be consumed too cold.
- Do not exceed storage time(s) recommended by food manufacturers for any kind of food, particularly for commercially quick-frozen food in the freezer compartment.
- It's recommended to wrap frozen food in several layers of parchment paper or newspaper to prevent an undue rise in the temperature while defrosting the refrigerator.
- An increase in temperature of frozen foods during manual defrosting, maintenance, or cleaning could shorten the storage life of the unit.

WARNINGS FOR DISPOSAL

Both the refrigerant (R600a isobutane) and cyclopentane foaming material used for this appliance are flammable. Therefore, when the appliance reaches the end of its service life, it should be kept away from any fire source and be disposed of according to local regulations so as to prevent damage to the environment or other harm.



When the refrigerator is disposed of, disassemble the doors and remove gasket of door and shelves. Put the doors and shelves in a proper place to prevent damage to the environment or any other harm.

Correct disposal of this product: This icon indicates this product should not be disposed with other household wastes. To prevent possible harm to the environment or human health from uncontrolled waste disposal, recycle it responsibly to promote the sustainable reuse of material resources.

OPERATION

PRODUCT COMPONENTS

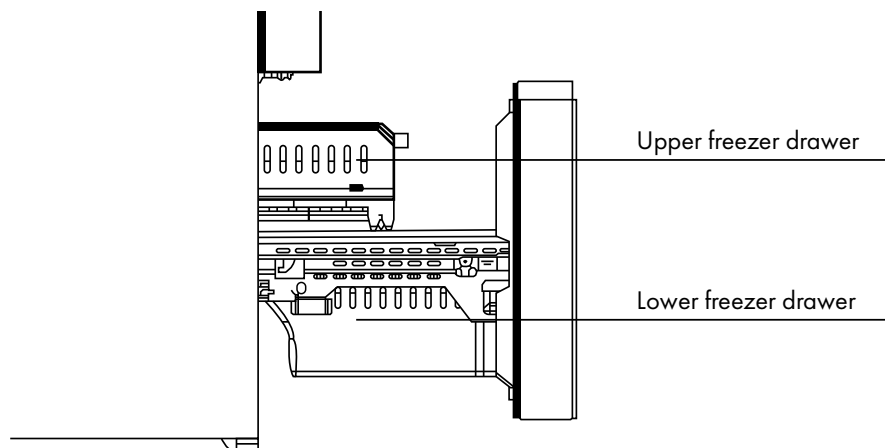
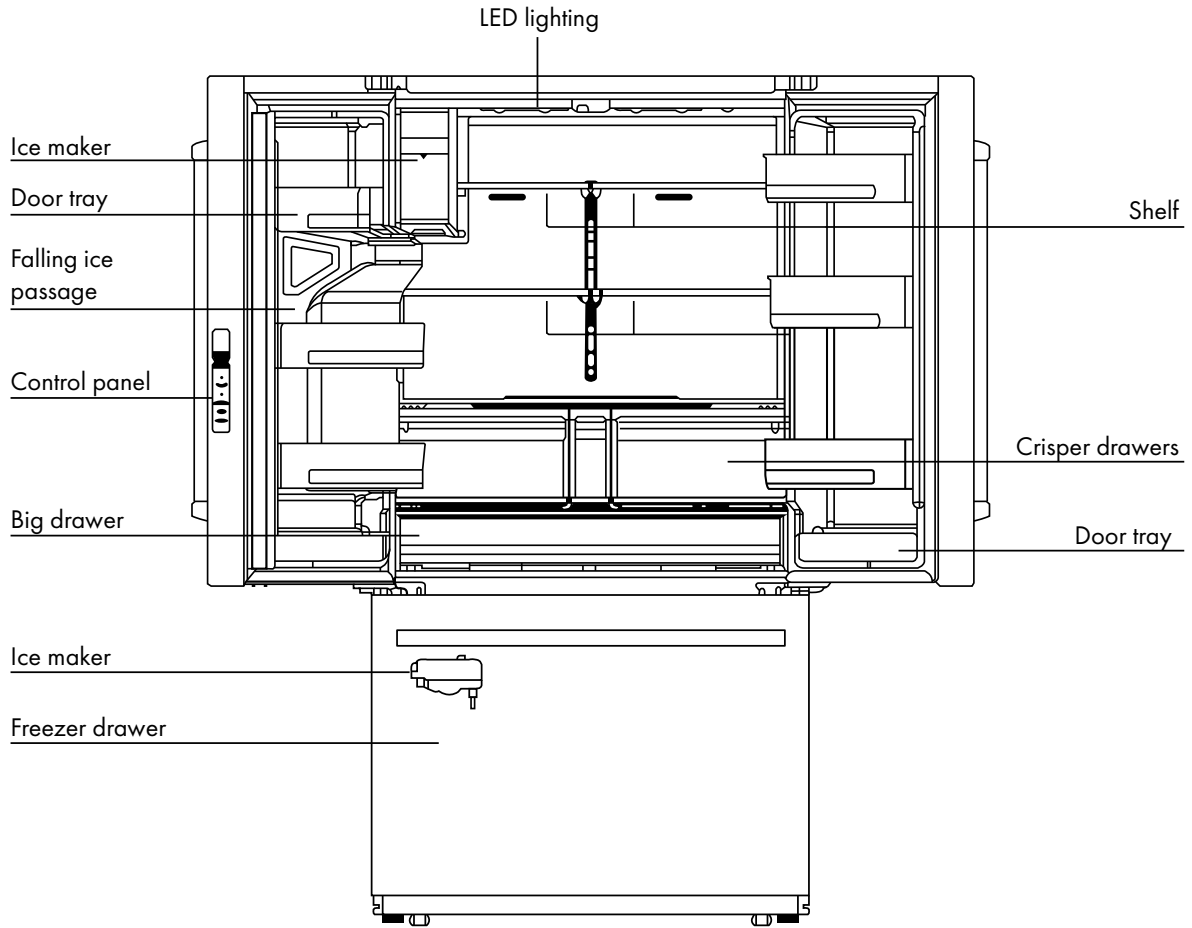

OPERATION

CONTROL PANEL OVERVIEW

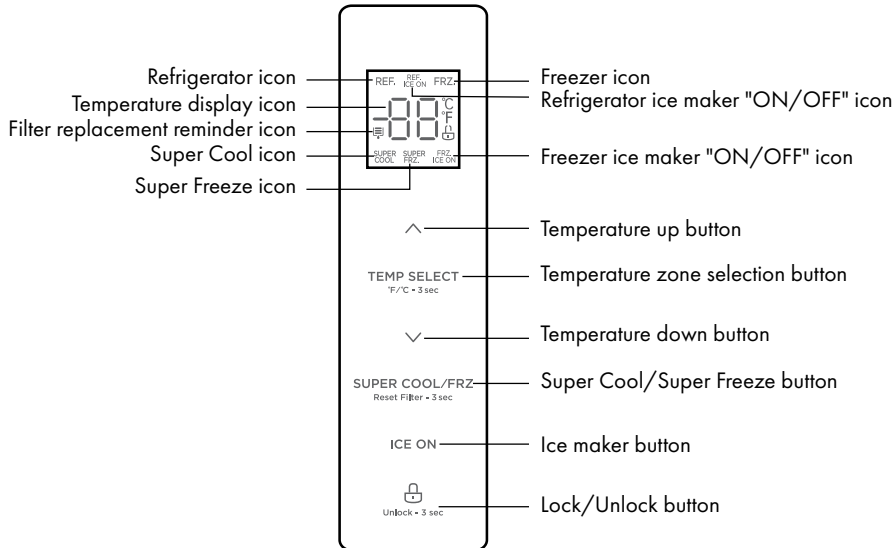

DISPLAY SCREEN

- When plugging in the refrigerator for the first time, the full display screen will illuminate for 3 seconds as a start-up chime sounds. After 3 seconds, the screen will enter normal display of operation.
- The default refrigerator temperature is 39 °F (4 °C). The default freezer temperature is 0 °F (-18 °C). Both will display by alternating back and forth.

DISPLAY SCREEN NOTES

- When changing functions on the control panel, the display screen lights will go out after 30 seconds once locked, no matter if the doors are open or closed. After 30 seconds, pressing any button on the panel will wake up the display screen.
- The display screen lights will turn on once any door is opened; in this instance, the light will go out immediately when the door is closed.
- If any error codes occur (see more on page 10), the display screen will illuminate and then go out after 30 seconds.
- While the control panel and/or display screen shown above may slightly differ from model to model, the controls and operation will be the same.

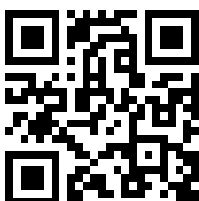

Scan to follow along with a video detailing how to operate the control panel.

OPERATION

RECOMMENDED TEMPERATURE

Optimal temperature settings are 39 °F (4 °C) for the refrigerator compartment and 0 °F (-18 °C) for the freezer compartment.



Optimal temperature settings are based on an optimal ambient temperature surrounding the unit of 77 °F (25 °C). Higher or lower ambient temperatures may impact the efficiency of your unit.



ENERGY SAVING TIPS

- Do not place the appliance near ovens, ranges, radiators, or other heat sources. If the ambient temperature is high, the compressor will run more frequently and for longer, resulting in increased energy consumption.
- Ensure that there is sufficient ventilation at the base of the appliance, on the sides of the appliance, and at the back of the appliance. Never cover ventilation openings.
- Please observe "Product Dimensions" and "Door Handle Installation" in the Installation Manual.
- The arrangement of drawers, shelves, and trays as shown in the "Product Components" illustration on "Product Components" on page 5 offers the most efficient use of energy for food storage and should therefore be retained as often as possible. All drawers and shelves should remain inside the appliance to keep temperatures stable and to conserve energy.
- If a larger storage space is needed (e.g. for large refrigerated goods), the middle drawers can be removed. The top and bottom drawers and shelves should be removed last if necessary.
- An evenly filled refrigerator/freezer compartment contributes to optimal energy use. Therefore, avoid empty or half-empty compartments.
- Allow warm food to cool before placing it in the refrigerator/freezer. Food that has already cooled down increases energy efficiency.
- Allow frozen food to defrost in the refrigerator. The coldness of the frozen food reduces the energy consumption in the refrigerator compartment and thus increases overall energy efficiency.
- Open the door only as briefly as necessary to minimize loss of cool air. Opening the door briefly and closing it properly reduces energy consumption.
- The door seals of your appliance must be intact so the doors close properly and energy consumption is not increased unnecessarily.





OPERATION

CONTROL PANEL OPERATION



LOCK/UNLOCK

- With the control panel in the locked state, press and hold the  button for 3 seconds to unlock the screen. A chime will sound. To lock the panel, press and hold  for 3 seconds. A chime will sound.
- The display screen will automatically lock if there is no button operation or after all doors are closed for 30 seconds.
- **NOTE:** You need to unlock the control panel to perform the following settings and functions; once finished, you can lock the panel yourself, or close the doors. The panel will automatically lock after the doors are closed for several seconds.







REFRIGERATOR TEMPERATURE SETTING

- Press  to change the temperature of the refrigerator compartment, each time you press  or , the set temperature will drop or rise in 1 °F/C increments. The refrigerator temperature range is 34–44 °F (1–7 °C).
- Press and hold  and  for 4 seconds to turn off/on the refrigerator compartment.

FREEZER TEMPERATURE SETTING



Press  to change the temperature of freezer compartment, each time you press  or , the set temperature will drop or rise in 1 °F/C increments. The freezer temperature range is -7 to 7 °F (-22 to -14 °C).

SUPER COOL/SUPER FREEZE MODES

- Press the  button to engage the Super Cool function. The refrigerator compartment is set at 34 °F (2 °C) automatically, and the  icon shines. When exiting Super Cool, the refrigerator will revert back to the previous temperature.
- Press  a second time to engage the Super Freeze function. The freezer compartment is set at -7 °F (-22 °C) automatically, and the  icon shines. When exiting Super Freeze, the freezer will revert back to the previous temperature.
- Pressing  three times will activate both Super Cool and Super Freeze modes; pressing  a fourth time will disengage both modes.

OPERATION

TURNING ON/OFF THE ICE MAKERS

- Press the  button to turn off or on the refrigerator and freezer ice makers. When the ice makers are on, indicator lights of each ice maker will display.
- Press  once to activate the refrigerator ice maker, twice for freezer, three times to activate both, and four times to turn both off.







RESET WATER FILTER

The water filter replacement icon will signify when to replace the filter, usually every 3-6 months. Press and hold  for 3 seconds to reset the icon.







SWITCHING FROM FAHRENHEIT TO CELSIUS

Press and hold  for 3 seconds to change to and from Fahrenheit and Celsius.



SABBATH MODE

- Press and hold  and  for 3 seconds to enter Sabbath mode, which allows you to open doors without activating interior lights or control panel functions.
- Hold the  button for 3 seconds to lock the panel; interior lights will go out and the display screen will only show the selected function in low brightness.
- To disengage Sabbath mode, unlock the control panel and press and hold  and  for 3 seconds. Hold the  button for 3 seconds to resume normal function.

ANTI-CONDENSATION HEATING ELEMENT

- The gray anti-condensation heater strip on the outside edge of the left door can be turned off/on. Press and hold  and  for 4 seconds. Once the Fahrenheit icon flashes, press , and the anti-condensation heating wire shutdown mode is set.
- To turn the element back on, unlock the panel and press and hold  and  for 4 seconds. Once the Fahrenheit icon no longer flashes, press the  button.

DOOR PROMPT ALARM

If doors are open for 2 minutes, the door alarm will chime 3 times. The alarm will go off again once a minute if doors remain open. The alarm can be stopped by pressing any button while the control panel is locked. Additionally, with the panel unlocked, press and hold the  and  buttons for 4 seconds to turn off/on the door prompt alarm.

OPERATION

ERROR CODES

If an error code appears on the display screen, it indicates a potential problem with the appliance. Although the refrigerator and freezer compartments may still provide cool/freeze functions during an error code, the user should contact maintenance personnel to ensure normal operation of refrigerator. You may also contact ZLINE Customer Service at 1-614-777-5004 for assistance.

Below is a list of common error codes that may occur with your appliance.

ERROR	ERROR CODE DESCRIPTION
CA	Communication failure with main control board and ice making board
CC	Defrosting sensor failure in ice making chamber
C9	Ice making chamber sensor failure
EE	Freezer ice maker sensor failure
EF	Water tank installation failure
EH	Humidity sensor failure
EP	Freezer ice maker fails to make ice
E0	Freezer ice maker initialization failure
E1	Refrigerator compartment temperature sensor failure
E2	Freezer compartment temperature sensor failure
E3	Variable chamber temperature sensor failure
E4	Refrigerator compartment defrost sensor failure
E5	Freezer compartment defrost sensor failure
E6	General communication failure
E7	Ambient temperature sensor failure
E8	Variable chamber defrost sensor failure
E9	Freezer compartment high-temperature alarm
F4	Sensor at bottom of refrigerator ice maker failure
F5	Refrigerator ice maker fails to make ice
F6	Refrigerator ice maker initialization failure



The anti-condensation heating element is installed for maintenance convenience. Do not toggle this frequently, as it will increase risk of condensation. It's recommended to turn the strip on for units installed in humid climates, while those in dry areas should have the strip turned off.

OPERATION

DISPENSING WATER AND ICE

The ice/water dispenser is located on the outside of left refrigerator door. It offers a choice of cubed ice, crushed ice, or cold water. The dispenser only works when the door is closed.

1. Cold water

- Press the WATER button once until the indicator light turns on.
- Push a glass or suitable beverage container onto the dispenser panel until cold water starts to flow. Remove the container from the dispenser panel to stop the flow of water.

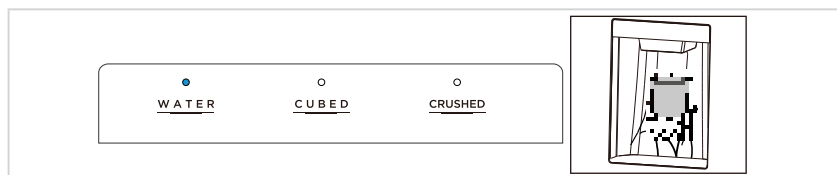

2. Crushed ice

- Press the CRUSHED button once until the indicator light turns on.
- Push a glass or suitable beverage container onto the dispenser panel and fill the container with crushed ice. Ice will start to flow within 2–3 seconds. Remove the container from the dispenser panel to stop the flow of ice.

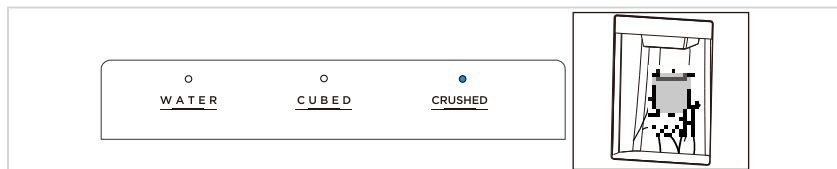

3. Cubed ice

- Press the CUBED button once until the indicator light turns on.
- Push a glass or suitable beverage container onto the dispenser panel and fill the container with cubed ice. Ice will start to flow within 2–3 seconds. Remove the container from the dispenser panel to stop the flow of ice.

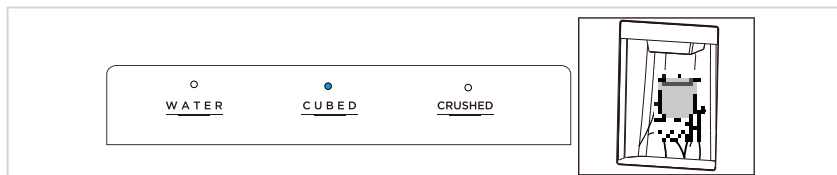

When dispensing cubed or crushed ice, ensure the container is adequately underneath the mouth of the dispenser to prevent ice from falling out the sides and onto the floor and increasing risk of injury.

OPERATION

FOOD STORAGE TIPS - FREEZER COMPARTMENT

- The freezer is designated for the storage of frozen food at very low temperatures, long-term storage of frozen food, and for production of ice.
- Only use the shelves in the door of the freezer to store frozen food, not for storing hot food designated for freezing. Let hot foods cool before freezing.
- Do not put fresh and frozen foods next to each other. The frozen food may thaw.
- When freezing fresh food such as meat, fish, or large vegetables, cut them into parts that can be used at the same time.
- When purchasing frozen food, make sure it was frozen at a suitable temperature and that the packaging is not damaged.
- Frozen food should be kept in suitable packages to retain quality and should be returned to the freezer compartment as soon as possible after removal.
- If a package of frozen food shows moisture or abnormal bulging, it likely was stored at the wrong temperature and the content may be spoiled.
- The storage period for frozen food depends on ambient temperatures, thermostat settings, frequency of opening the door of the freezer, and the type of food. Always follow manufacturer instructions printed on the packaging. If there is no information, food should not be stored for longer than three months from date of purchase.

FOOD STORAGE TIPS - REFRIGERATOR COMPARTMENT

- To reduce moisture and subsequent ice build-up, never put liquid inside the refrigerator in unsealed containers. Frost tends to concentrate in the coolest parts of the evaporator. Storing uncovered liquids results in a more frequent need for defrosting.
- Never put hot or warm foods in the refrigerator. These should first cool down to room temperature to ensure adequate air circulation in the refrigerator.
- Foods or food containers should not touch the back wall of the refrigerator because they could freeze to the wall.
- Do not keep regularly opening the door of the refrigerator.
- Meat, fish, and poultry (recommended to be contained in a package or plastic foil) can be placed in the refrigerator, so long as the food is used within 1–2 days.
- Fruit and vegetables without packaging should be placed in the crisper drawer, which is designated for fresh produce.

CLEANING AND MAINTENANCE

OVERALL CLEANING OF THE APPLIANCE

- Dirt and dust build-up behind the refrigerator and on the surrounding floor should be cleaned frequently to improve cooling efficiency and save energy.
- Check the door gaskets regularly to make sure there is no debris. Clean door gaskets with a soft cloth dampened with soapy water or a diluted kitchen-safe cleaner.
- The interior of the refrigerator should be cleaned regularly to avoid odor.
- Remove all food, drinks, shelves, drawers, etc., before cleaning the interior.
- Mix 2 tablespoons of baking soda with a quart of warm water and use a soft cloth or sponge to clean the inside of the refrigerator. After wiping clean, open the door and let the appliance dry naturally before turning on the power.
- For areas that are difficult to clean in the refrigerator (such as narrow crevices, gaps, or corners), it is recommended to wipe them regularly with a soft rag, soft brush, etc., and when necessary, use non-metal or abrasive tools (such as toothpicks or Popsicle sticks) to ensure no contaminants or bacteria accumulate.
- Do not use soap, detergent, scrub powder, spray cleaner, etc., as these may cause odors in the interior of the refrigerator or contaminate food.
- Clean the shelves and drawers with a soft cloth dampened with soapy water or a diluted kitchen-safe cleaner. Dry with a soft cloth or dry naturally.
- Wipe the outer surface of the refrigerator with a soft cloth dampened with a stainless steel cleaner, soapy water, detergent, etc., and wipe dry.
- Do not use hard brushes, steel cleaning balls, wire brushes, abrasives (such as toothpastes), organic solvents (such as alcohol, acetone, banana oil, etc.), boiling water, or acid or alkaline items, as they may damage the refrigerator surface and interior. Please note that boiling water and organic solvents such as benzene may deform or damage plastic parts.
- Do not spray water or other liquids directly into or on the refrigerator during cleaning to avoid short circuits and negatively impact electrical insulation.



WARNING Always disconnect the appliance from power before cleaning the interior to avoid risk of electric shock or injury.

CLEANING AND MAINTENANCE

CHANGING INTERIOR LIGHTS

Replacement or maintenance of the interior LED lights are only to be performed by a professional electrician. If the customer is within warrant, please contact ZLINE Customer Service at 1-614-777-5004 for assistance.

DEFROSTING

The refrigerator is manufactured based on basic air-cooling principles and has an automatic defrosting function. Frost formed due to change of season or ambient temperatures may be manually removed by disconnecting the appliance from power supply and by wiping with a dry towel.

CLEANING DOOR TRAYS

- Following the direction of the arrows in the figure below, use both hands to squeeze each tray and push it upward, and then take it out to clean. Replace following the reverse of the steps above.
- When replacing a cleaned tray, you can adjust the install height as necessary by using the different rows of slots along the side of the door.

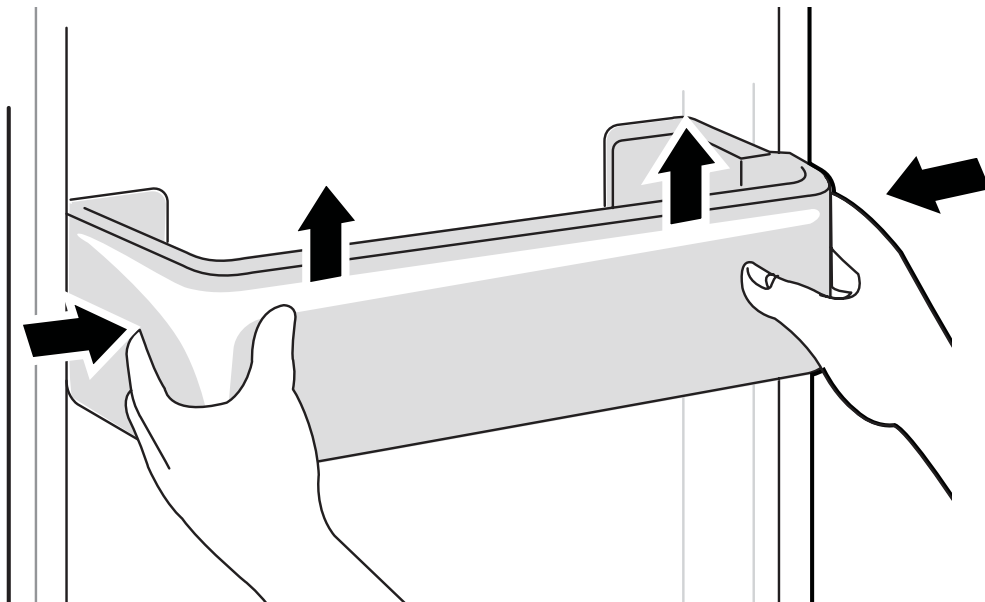

CLEANING AND MAINTENANCE

CLEANING GLASS SHELVES

Following the direction of the arrows in Figure 2 below:

1. Firmly hold the front edge of shelf and tilt the shelf inwards until the lower end of the fixed leg is separated from the slot of supporting iron, as shown in Figure 1.
 2. Lift the whole shelf up it cannot rise anymore.
 3. Take out the shelf horizontally to fully remove it for cleaning.
- When replacing cleaned shelves, place the upper end of the fixed leg into one of the upper slots on the supporting iron first, and then put the lower end of the fixed leg into the third slot on the lower part of the supporting iron.

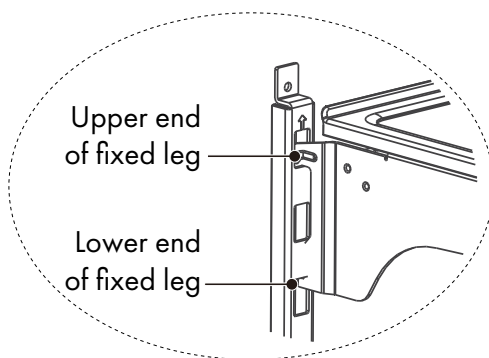

Figure 1

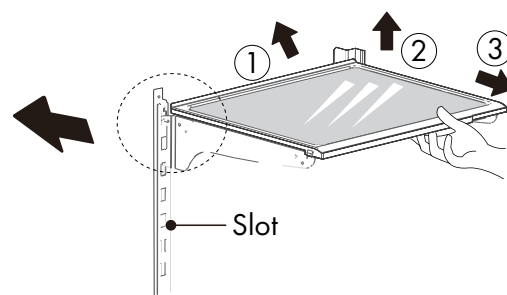

Figure 2

CLEANING AND MAINTENANCE

CLEANING THE REFRIGERATOR ICE STORAGE BUCKET

- When you need a lot of ice or you want to clean the ice storage bucket, you can remove it. Replace the bucket quickly if dumping ice to not disrupt ice maker operation.
- When removing the bucket, clean up any ice cubes that may have fallen.
- It's recommended to turn the refrigerator ice maker off when cleaning the bucket.

①

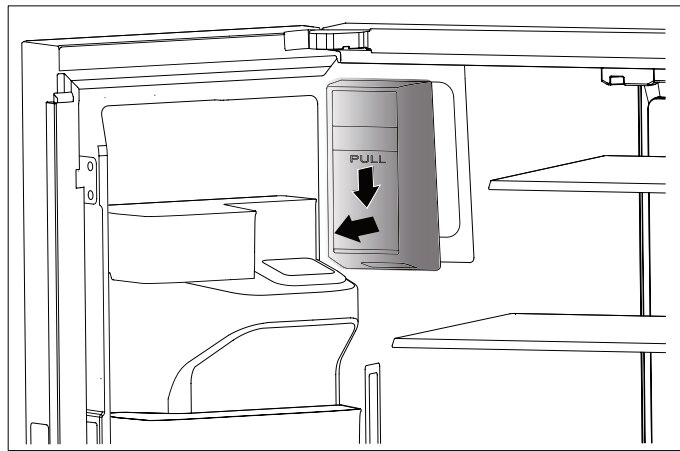

- Hold the handle of the ice bucket with your hand, press it gently, and then pull it out horizontally as noted in the image above. It should come out easily.

②

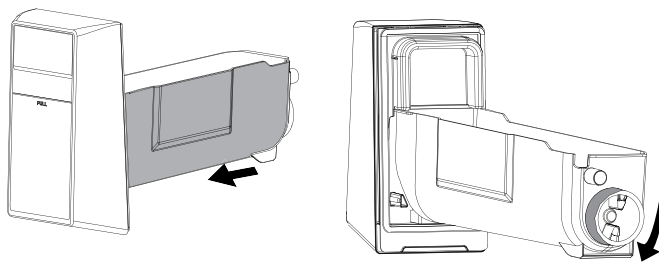

- After dumping ice or cleaning, push the ice bucket back in. It should slide in easily. If it doesn't, rotate the tail as illustrated in the image above to align it with the corresponding position in the ice tank.



When using the ice maker for the first time, it's recommended to dump out the first 2–3 batches of ice to allow for proper water flow and to rid the water line and ice-making system of any potential debris.

CLEANING AND MAINTENANCE

CLEANING OF FREEZER DRAWER

CLEANING THE UPPER FREEZER DRAWER

1. Open the freezer door to the maximum length.
2. Hold the left and right sides of the upper drawer with both hands, pull the slide rail so it cannot move, and push the drawer forward to separate the drawer from the support hinge of the slide rail.
3. Rotate the drawer back and up to remove it from the freezer chamber.

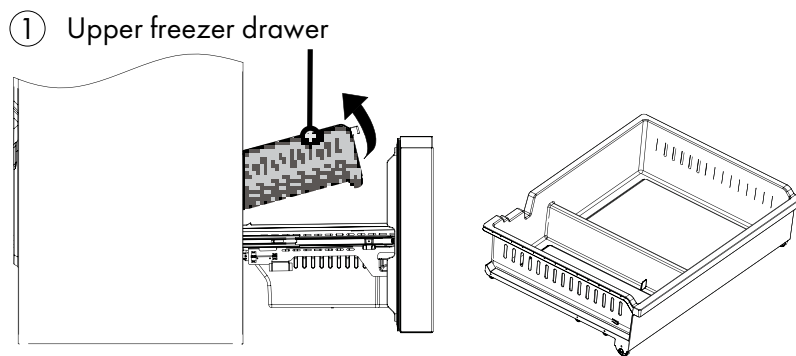

CLEANING THE LOWER FREEZER DRAWER

1. Open the freezer door to the maximum length.
2. Hold the left and right sides of the lower drawer with both hands.
3. Lift the front end with a little force to pull the drawer back slightly until the support hinge of the slide rail is separated from the drawer.
4. While pulling the front end of the drawer at an angle, rotate the drawer back and up to take it out.

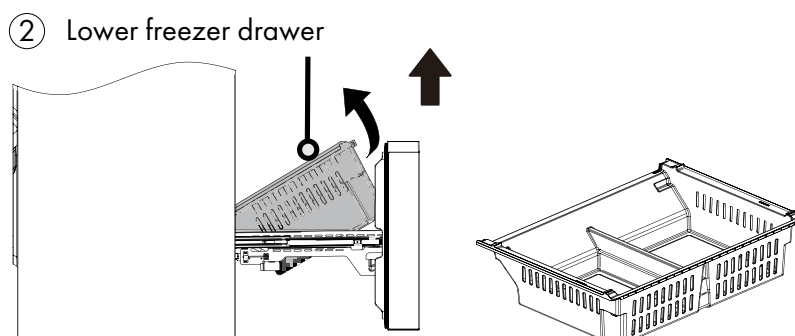

CLEANING AND MAINTENANCE

OUT OF OPERATION

POWER FAILURE

In case of unexpected power failure, even if it is in summer, food inside the appliance can be kept cool for several hours. During the power failure, decrease the amount of times the refrigerator and freezer doors are opened; each time a door is opened, cool air that cannot be replaced escapes. Do not add more fresh food into the appliance during a power failure.

LONGTIME NON-USE

In the event you do not plan to use the appliance for extended time periods, fully disconnect the unit from power, clean the complete interior, and leave the doors ajar to prevent unwanted odors.

MOVING THE APPLIANCE

- Before moving the refrigerator to a different location, remove all objects from inside and secure the glass shelves, refrigerator drawers, freezer drawers, etc., with tape.
- Tighten the leveling feet, close all doors, and secure them with tape.
- Use at least one helper during transport. Do not lay the refrigerator upside down or horizontally or allow it to vibrate during transport, as this increases the damage to the sealed cooling system.
- When moving the unit with a hand truck, do not tilt the unit more than 45°, as this may also disrupt the sealed cooling system.



After moving the appliance to a new location, re-connect to power and let it run continuously. Generally, operation of the appliance should not be interrupted; otherwise, the service life may be impaired.

TROUBLESHOOTING

POSSIBLE FAULT	POSSIBLE FAULT/SOLUTION
Failed operation	Check whether the appliance is connected to power and/or whether the plug is securely plugged in.
	Check whether the voltage is too low.
	Check whether there is a power failure or partial circuits have tripped.
Odor	Odorous food should be tightly wrapped.
	Check whether there is any spoiled food.
	Clean the inside of the refrigerator.
The compressor operates for a long time	Long operation of the refrigerator is normal in summer when the ambient temperature is high.
	Do not put too much food in the appliance at the same time.
	Food should be cooled before being put into the appliance.
	The doors are opened too frequently.
	The condenser may be dirty and should be cleaned with care.
Light doesn't turn on	Check whether the refrigerator is connected to power supply and/or whether the light is damaged.
Doors cannot be properly closed	The door is obstructed by food packages.
	The refrigerator is tilted. Tighten the legs and make sure the unit is perfectly level.
Loud noises	Check whether the floor is level and whether the refrigerator is placed stably.
	Check whether accessories are placed in proper locations.
Door seal is not tight	Remove foreign matters on the door seal.
	Heat the door seal and then cool it for restoration (or blow it with an electrical drier or use a hot towel for heating).
Water pan overflows	There is too much food in the chamber or food stored contains too much water, resulting in heavy defrosting.
	The doors are not closed properly, resulting in frosting due to the entry of air and increased water due to defrosting.
Surface condensation	Condensation on the exterior surface and door seals of the refrigerator is normal when the ambient humidity is too high. Wipe the condensation with a clean towel.
Abnormal noises	The compressor may produce buzzes during operation and the buzzes are loud particularly upon start or stop. This is normal.

TROUBLESHOOTING

POSSIBLE FAULT	POSSIBLE FAULT/SOLUTION
Hot housing	This is heat dissipation of the built-in condenser via the housing, which is normal. When housing becomes hot due to high ambient temperatures or too much food storage, it's recommended to provide sound ventilation to facilitate heat dissipation. Hot housing can also be caused by the refrigerator cooling frequently. This is normal doors are opened or left open for long periods of time.
Ice makers do not make ice	After you install the water line and start the refrigerator, it may take 12 hours to start producing ice.
	Turn on the ice making functions (see page 9).
	Check whether the water pressure meets 40–100 psig (0.28–0.69 MPa) and whether the water line is connected normally.
	Check whether the water supply valve is open and whether the water pipe is bent.
No ice is dispensed in the refrigerator	Check whether there is ice in the ice bucket.
	Check whether the ice has melted and stuck together. If the ice is not used for a long time, empty the ice bucket and turn off the ice maker.
	Check whether the water line is connected normally, whether the water supply valve is opened, and whether the water pipe is bent.
	The ice dispenser will only operate when the refrigerator door is closed. Check whether the ice bucket is properly installed.
Ice makers not making enough ice	Low water pressure can result in slower ice-making speeds. Consult a professional regarding your home's recommended psi limits to achieve optimal ice-making conditions.
No water is coming out of the water dispenser	Check whether the water line is connected normally, whether the water supply valve is opened, and whether the water pipe is bent or creased.
	The filter or water filter bypass plug must be installed before water can be discharged.
There is low flow coming from the water dispenser	Check whether the water pressure meets 40–100 psig (0.28–0.69 MPa).
	Replace the water filter following the instructions in the Installation Manual. If filter doesn't work, call ZLINE Customer Service at 1-614-777-5004.
The water tastes bad	Check the water filter. Replace the water filter as described in the Installation Manual. If the new water filter still does not correct the water dispenser flow, call ZLINE Customer Service at 1-614-777-5004.

WARRANTY

COVERAGE

ZLINE Kitchen and Bath ("ZLINE") standard-depth refrigerators have a one year parts and service warranty and a five year parts warranty on the unit's sealed cooling system.

ZLINE warranty periods begin from the original date of product delivery and solely cover the original purchaser of the product, delivered new and in its original carton. The limited warranty covers all parts and labor for necessary repairs if any part of the product, or the product itself, proves to be defective in materials or workmanship.

The product must be deemed serviceable via troubleshooting with the ZLINE Customer Experience team. All service on ZLINE products under warranty must be performed by ZLINE-approved and ZLINE-certified service providers unless otherwise specified by ZLINE. Service will be provided during normal business hours.

Products must be unobstructed and accessible to the service provider at the time of service. ZLINE's liability is limited to the original purchase price of the product. Additional injuries, losses, damages, or other inconveniences caused by product malfunction or defects in materials are not covered under the terms of this warranty.

TERMS

ZLINE warranties apply only to the original purchaser of a ZLINE product installed for normal residential use. This is defined as a single-family, residential dwelling in a non-commercial setting. Any warranty claim stemming from installation, operation, or any other use within a commercial setting is not covered under this limited warranty. Commercial settings include, but are not limited to: schools, churches, hotels, restaurants, vacation rentals such as Airbnb, daycare centers, private clubs, fire stations, common areas in multi-family dwellings, nursing homes, food service locations, and institutional food service locations such as hospitals or correctional facilities.

This warranty is non-transferable and will not under any circumstance be extended based on the date of installation — the warranty period takes effect from the date of delivery and only covers the original purchaser. The warranty applies only to products installed in the contiguous United States and the District of Columbia.

WARRANTY

Failure to secure certified warranty service per these terms will result in a forfeiture of the remaining warranty. Out-of-pocket payments will not be reimbursed unless prior approval is received from ZLINE and/or ZLINE-certified service contract partners. Unapproved out-of-pocket payments for service will not be reimbursed. All warranty procedures must be followed to maintain warranty coverage.

If a product qualifies within the service window provided under these warranty terms, and ZLINE is unable to repair the product or a defective part of the product after a reasonable number of attempts, ZLINE reserves the right to offer to replace the defective part or the product or provide the original purchaser a full refund of the purchase price of the product (not including installation, removal, or other charges that were not included in the original purchase price).

The original purchaser of the product must provide the original proof of purchase, including the purchase date, when filing a claim to obtain replacement parts, service, or refunds. Additionally, the original purchaser of the product must provide the serial number of the product when filing a claim to obtain replacement parts, service, or refunds.

This warranty shall not apply to any ZLINE product in which the original factory serial number has been removed, altered, or cannot be readily determined for any reason. Further, ZLINE is not responsible for damage resulting from, but not limited to: shipment, delivery, or improper installation; negligence or improper maintenance, misuse, or abuse of the product; unauthorized alteration, modification, or tampering with the product; accident, fire, floods, pest infestations, pandemics, natural disasters, or any other unpreventable or unexplained acts of nature, commonly referred to as "acts of God"; flare-up fires or damages caused by improper electric supply, electrical line current, voltage, or power surges; and service to correct installation not in accordance with the instructions contained in ZLINE's product manuals and/or with local government codes.

In the event service is dispatched, and it is discovered that the reported issue is not covered under warranty based on the disclaimers above, the customer will be responsible for all service fees. Failure to pay these fees will result in the forfeiture of remaining warranty coverage.

WARRANTY

Information contained within ZLINE's installation and user manuals, in addition to product information included on ZLINE's website and all related digital listings, do not cover every possible condition and situation that may occur during the installation or operation of ZLINE products.

ZLINE reserves the right to make changes at any time to its products when considered safe, necessary, and useful. Always check the ZLINE website for the most up-to-date version of its product manuals: www.zlinekitchen.com/pages/manuals.

Do not install or operate any ZLINE product if it has missing or broken parts or if it arrives damaged due to shipping. If ZLINE products arrive damaged, contact ZLINE Customer Experience at 1-614-777-5004 for help. Failure to report a damaged appliance prior to installation or operation may void the warranty.

ZLINE disclaims responsibility for damage or injury caused by improper installation or use of any of its products. ZLINE is under no obligation, by law or otherwise, to provide concessions, including repairs, prorates, rebates, discounts, or replacements, once the warranty has expired.

SERIAL NUMBER LOCATION

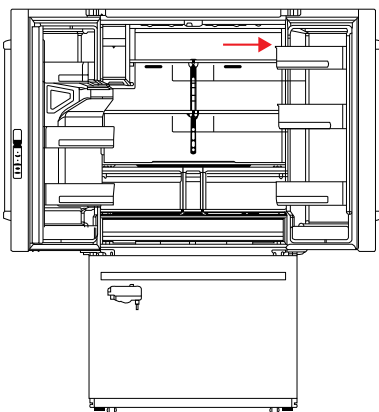

The rating tag shows the model and serial number of your refrigerator. The product label and rating tag is located inside the unit on the top right-hand side. The tag is visible when the refrigerator door is open. Do not remove permanently affixed labels, warnings, or plates from the product. This will void the warranty.

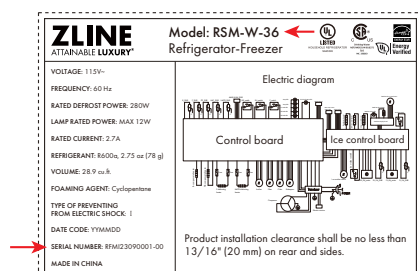

WARRANTY



SERVICE

For warranty service, please contact our Customer Service team at 1-614-777-5004 or visit www.zlinekitchen.com/contact to utilize our online Customer Experience Portal.

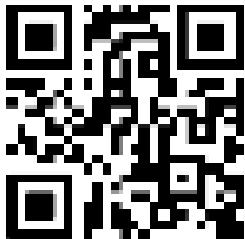

Scan the QR code to view the most up-to-date version of our Installation Manual and User Manual.

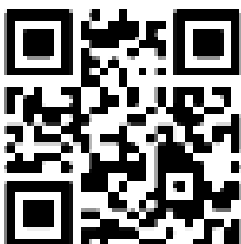

Need to purchase a part or accessory for your ZLINE product?
Visit www.zlineparts.com, ZLINE's official parts distribution partner.

2.0.4

1-614-777-5004

www.zlinekitchen.com

contact@zlinekitchen.com

ZLINE
ATTAINABLE LUXURY®