

Drawer Features

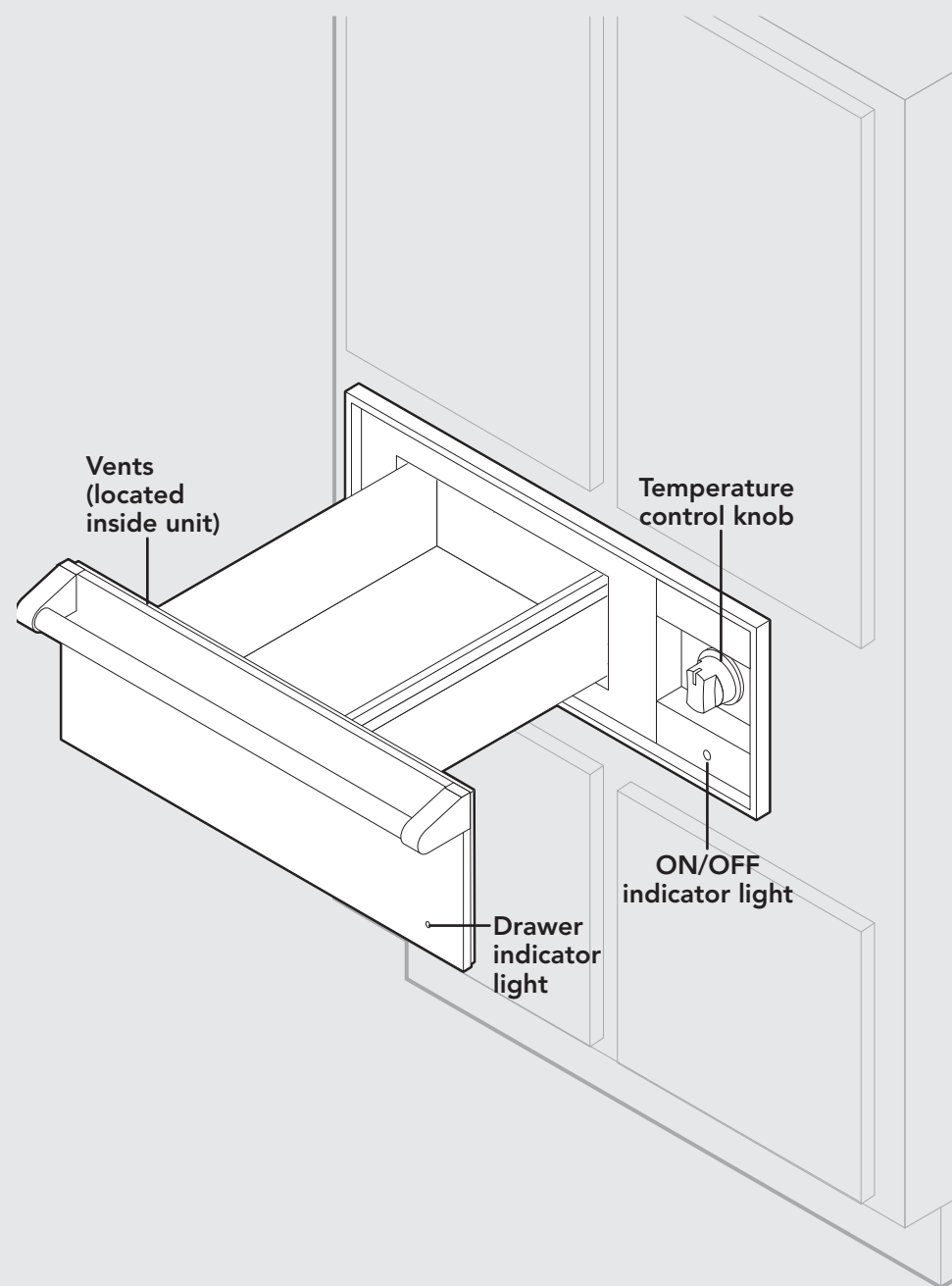

Operation

Before Using Drawer

All products are wiped clean with solvents at the factory to remove any visible signs of dirt, oil, and grease which may have remained from the manufacturing process. Before using, clean the drawer thoroughly with hot, soapy water. There may be some burn off and odors on first use of the appliance—this is normal.

Drawer Functions

- Your warming drawer works in two ways:
1. Seals moisture within the drawer to keep food moist.
 2. Allows moisture to escape and keep food crisp.

The purpose of the warming drawer is to keep hot, cooked foods at serving temperature. Always start with hot food; cold food cannot be heated in the warming drawer.

Warming Element

Turn the control knob clockwise to the desired setting. The element will cycle on and off to maintain the desired heat setting. When finished turn the control to "OFF."

Note: The majority of foods are held at a medium setting to maintain a serving temperature.

To use Dry Heat Function

1. Place the food or cookware with food in the empty drawer pan.
2. Turn the control knob to the desired heat setting and close the drawer.

Use dry heat when warming dishes and keeping foods crispy such as pies, breads and fried foods.

Drawer Indicator Light

The drawer indicator light is located on the front panel of the drawer. The drawer indicator light will glow blue when the drawer element is heated. The light will cycle on and off as the temperature is maintained.

Optional Accessories for Dry Heat

Pans/Lids - This warming drawer is designed to accommodate standard size pan inserts. The optional pan/lid set consists of:

- 1) one 4" D. x 12" L. x 10½" W. pan/lid
- 2) two 4" D. x 12" L. x 7" W. pans/lids
- 3) two 2½" D. x 12" L. x 7" W. pans/lids

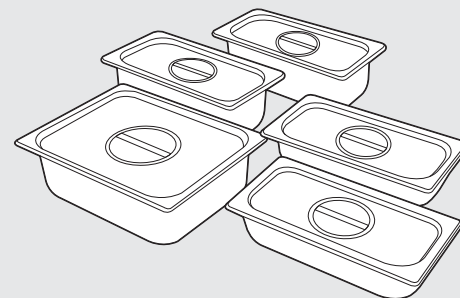

Temperature Control Settings

The knob is used to select the temperature of the drawer and is located on the right side of the control panel. The "1" setting represents low, "2" represents medium, and "3" represents high. The majority of foods are held at a medium setting to maintain a serving temperature. However, your own preference may be for hotter foods.

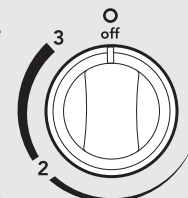

To keep several types of food hot for serving, key the temperature setting for the meat. For example, to hold rare roast beef, select a lower setting, cover the other foods that otherwise would be kept at a higher setting.

Repeated opening of the drawer allows the hot air to escape and the food to cool. The drawer should not be opened unless adding or removing food.

Operation (cont.)

Proofing

Yeast dough can be proofed in the warming drawer. Place the dough in a bowl. Place the bowl on the low rack in the drawer. Turn the temperature control to the lowest setting to facilitate the fermentation time. A towel should be placed over the dough to minimize surface drying. The dough should remain in the warming drawer until it has doubled in size and a slight depression remains when the surface is touched gently with a finger.

Warming Plates

To warm serving bowls and plates, place temperature control on a low setting. Place the empty dishes on the low rack to raise them off the bottom of the drawer. If you want hotter dishes or want to heat fine china, please check with the manufacturer of the dishes for their maximum heat tolerance.

Power "ON" Light

The power "ON" light is located below the temperature control knob on D3 models. It turns on when the control knob is set and cycles on and off with the heating element as temperature is maintained.

Suggested Heat Settings

The information below is given as a guide only. You may need to vary the heat settings to suit your personal requirements.

Food	Temperature Settings
Bacon	2 – 3
Beef, medium and well done	2
Beef, rare	1 – 2
Bread, hard roll	2
Bread, soft rolls	2
Casseroles	2
Cooked cereal	2
Dough, proofing	1
Eggs	2
Fish, seafood (baked)	2
Fried foods	3
Fruit	2
Gravy, creamed sauces	2
Ham	2
Pancakes, waffles	2 – 3
Pies, one crust	2
Pies, two crust	2
Pizza	2 – 3
Pork	2
Potatoes, baked	3
Potatoes, mashed	2
Poultry	2 – 3
Vegetables	2

Warnings

Warning and Important Safety Instructions appearing in this guide are not meant to cover all possible conditions and situations that may occur. Common sense, caution, and care must be exercised when installing, maintaining, or operating the appliance.



ALWAYS contact the manufacturer about problems or conditions you do not understand.

Recognize Safety Symbols, Words, Labels

 DANGER
Hazards or unsafe practices which WILL result in severe personal injury or death
 WARNING
Hazards or unsafe practices which COULD result in severe personal injury or death
 CAUTION
Hazards or unsafe practices which COULD result in minor personal injury. All safety messages will identify the hazard, tell you how to reduce the chance of injury, and tell you what can happen if the instructions are not followed.

Read and follow all instructions before using this appliance to prevent the potential risk of fire, electric shock, personal injury or damage to the appliance as a result of improper usage of the appliance. Use appliance only for its intended purpose as described in this guide.

To ensure proper and safe operation: Appliance must be properly installed and grounded by a qualified technician. **DO NOT** attempt to adjust, repair, service, or replace any part of your appliance unless it is specifically recommended in this guide. All other servicing should be referred to a qualified servicer.

 WARNING
 To avoid risk of property damage, personal injury or death; follow information in this manual exactly to prevent a fire or explosion. DO NOT store or use gasoline or other flammable vapors and liquids in the vicinity of this or any appliance.

To Prevent Fire or Smoke Damage

- Be sure all packing materials are removed from the appliance before operating it.
- Keep area around appliance clear and free from combustible materials, gasoline, and other flammable vapors and materials.
- Many aerosol-type spray cans are **EXPLOSIVE** when exposed to heat and may be highly flammable. Avoid their use or storage near an appliance.
- Many plastics are vulnerable to heat. Keep plastics away from parts of the appliance that may become warm or hot. **DO NOT** leave plastic items in the drawer as they may melt or soften if left too close to a heating element.
- Combustible items (paper, plastic, etc.) may ignite and metallic items may become hot and cause burns. **DO NOT** pour spirits over hot foods.

About your Appliance

- **DO NOT** touch the heating elements or interior surface of the drawer while it is in use. Use handles or knobs.
- **DO NOT** store flammable materials in drawer.

Heating Elements

- Use only dry potholders. If moist or damp potholders are used, steam from potholders could cause a steam burn. **DO NOT** let potholders touch hot heating elements located under the drawer. **DO NOT** use a towel or bulky cloths in place of potholders.
- Use care when opening the drawer. Let hot air or steam escape (open vent) before removing or replacing food.
- **DO NOT** place food in unopened containers in the drawer. Pressure could build up and cause the container to burst.
- **NEVER** use the appliance for other than intended use.
- **DO NOT** use water on grease fires. Smother fire or flame or use dry chemical or foam-type extinguisher.
- **DO NOT** use aluminum foil to line the drawer. It is an excellent heat insulator and will trap heat beneath it. This will upset the performance and can damage the interior finish.
- Always place warming racks in desired position while drawer is cool.
- Keep drawer closed when not in use.
- **DO NOT** place items exposed to cooking oils in your warming drawer. Items contaminated with cooking oils may contribute to a chemical reaction that could cause a load to catch fire.
- **DO NOT** install or store indoor models where they will be exposed to the weather.



Warnings (cont.)

 WARNING
NEVER use this appliance as a space heater to heat or warm the room. Doing so may result in carbon monoxide poisoning and overheating of the drawer.

 CAUTION
DO NOT use plastic wrap to cover foods placed in the drawer, nor to keep foods warm that are wrapped or placed in plastic containers for heating. Plastics can melt onto the drawer if they are in direct contact. If melted onto the drawer, they can be very difficult to remove.

 CAUTION
DO NOT use any cleaning agent with chlorine or chlorine compounds on stainless steel finish. Chlorine and chlorine compounds are corrosive to stainless steel.

 WARNING
To avoid sickness and food waste, do not allow defrosted food to remain in the drawer for more than two hours.

 WARNING
 BURN OR ELECTRICAL SHOCK HAZARD Make sure all controls are OFF and drawer is COOL before cleaning. Failure to do so can result in burns or electrical shock.

 WARNING
If the information in this manual is not followed exactly, a fire or explosion may result causing property damage, personal injury or death.

 WARNING
NEVER cover any slots, holes or passages in the drawer or cover an entire rack with materials such as aluminum foil. Doing so blocks air flow through the oven and may cause carbon monoxide poisoning. Aluminum foil linings may also trap heat, causing a fire hazard.



Quick Reference GUIDE

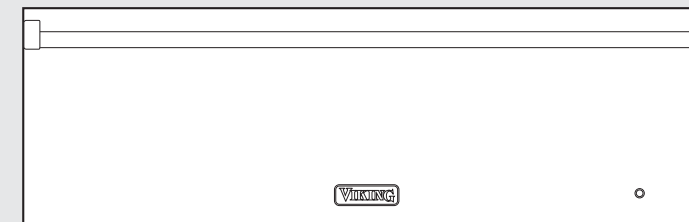

VIKING

Built-In Electric Warming Drawer

