

# SAPPHIRE

Adapting to Your Environment

Indoor, Outdoor and ADA

Wine Refrigerators | Ice Machines | Beverage Centers | Glass Door Refrigerators | Accessories

## 24" Beverage Centers

SBCR24 Indoor & ADA Height Models

 **WARNING**

**California Proposition 65**

**Certain components in this product and its related accessories contain chemicals known to the state of California to cause cancer, birth defects or other reproductive harm.**

**PRODUCT REGISTRATION INFORMATION**

Please record your model's information. You will need to know this information whenever you call to request information or service. The model's information appears on a serial number plate.

**Model Number:** \_\_\_\_\_

**Serial Number:** \_\_\_\_\_

You can register your appliance at:

SapphireAppliance.com

Or

Fill out the provided Warranty Registration Card and mail in.

Congratulations on your new SAPPHIRE Beverage Center/Refrigerator. To ensure proper operation, please read this Operator's Manual carefully before using this product. Keep this manual in a safe place for future reference.

# TABLE OF CONTENTS

<b>SAFETY</b> .....	<b>3</b>
SAFETY DEFINITIONS.....	3
SAFETY PRECAUTIONS .....	3
<b>SPECIFICATIONS</b> .....	<b>6</b>
SAPPHIRE 24-INCH INDOOR BEVERAGE CENTER .....	6
<b>INSTALLING THE UNIT</b> .....	<b>7</b>
REQUIRED CABINET OPENING .....	9
BUILT-IN CABINET DIMENSIONS .....	9
SAPPHIRE 24-Inch Indoor Cabinet Dimensions .....	9
SAPPHIRE 24-Inch ADA Height-Compliant Built-In Cabinet Dimensions .....	10
ELECTRICAL CONNECTION.....	11
AVOIDING USE OF EXTENSION CORDS.....	12
LEVELING THE UNIT.....	12
REVERSING THE DOOR .....	13
CUSTOM DOOR PANEL.....	14
24-inch Indoor Full-Size Doorframe.....	15
24-inch ADA Height-Compliant Doorframe .....	15
Installing the Custom Door Panel .....	16
ANTI-TIP SYSTEM .....	17
INTEGRATED GRILL/PLINTH.....	17
<b>OPERATING THE UNIT</b> .....	<b>18</b>
USING THE CONTROLS .....	18
Turning the Unit On .....	18
Turning the Unit Off .....	19

Entering the Display of Menu Items.....	20
Lighting Options.....	22
Lighting Options - Scheduling Nightlight.....	23
Lighting Options - Turning Nightlight Off.....	32
Setting Temperature .....	33
Entering Sabbath Mode.....	34
Exiting or Cancelling Sabbath Mode .....	36
Changing / Adjusting the Temperature.....	36
Default Temperature .....	37
Clearing Simple Error Codes.....	38
Other / Additional Error Codes.....	38
Manually Clearing Temp Out of Range Error Code .....	39
<b>EXPECTING NORMAL SOUNDS .....</b>	<b>40</b>
<b>DEALING WITH POWER FAILURE .....</b>	<b>40</b>
<b>CARE AND MAINTENANCE.....</b>	<b>41</b>
<b>CLEANING AND MAINTAINING THE UNIT .....</b>	<b>41</b>
Cleaning the Unit's Exterior .....	41
Cleaning the Unit's Interior .....	41
Extended Periods of Non-Use .....	42
Recommissioning the Unit.....	42
Starting Up the Unit .....	42
Cleaning the Condenser.....	42
<b>TROUBLESHOOTING .....</b>	<b>44</b>
<b>DISPOSING THE UNIT .....</b>	<b>45</b>
<b>WARRANTY .....</b>	<b>46</b>

# 1 | SAFETY

## SAFETY DEFINITIONS

The words DANGER, WARNING, CAUTION and NOTICE are used throughout this manual to highlight important information. Be certain that the meanings of these alerts are known to all who operate and install the appliance.

### DANGER

Indicates a hazardous situation that, if not avoided, *will* result in death or serious injury.

### WARNING

Indicates a hazardous situation that, if not avoided, *could* result in death or serious injury.

### CAUTION

Indicates a hazardous situation that, if not avoided, *could* result in minor or moderate injury.

### NOTICE

Indicates a situation that can cause damage to the appliance and/or the environment, or cause the appliance to operate improperly.

## SAFETY PRECAUTIONS

### POWER CORD PRECAUTIONS

- Do not use the appliance if the power cord is damaged. If the power cord is damaged, have a qualified electrician replace the power cord.
- Never lift, carry or drag the appliance by the power cord.
- Do not connect or disconnect the electric plug when your hands are wet.
- Never unplug the appliance by pulling on the power cord. Always grip the plug firmly and pull straight out from the outlet.

### **INSTALLING PRECAUTIONS**

- Keep ventilation openings, in the appliance enclosure or in the built-in structure, clear of obstruction.
- To avoid a hazard due to instability of the appliance, the appliance must be installed in accordance with the instructions.

### **MOVING PRECAUTIONS**

- When moving the appliance, do not turn it upside-down and do not unlevel it more than 45 degrees.
- Do not move the appliance without emptying it and securing the door in the closed position.

### **OTHER PRECAUTIONS**

- To ensure proper ventilation for the appliance, keep obstructions away from the front of the unit.
- Keep fingers out of the “pinch point” areas. Clearance between the door and cabinet are necessarily small. Be careful closing the door when children are in the area.
- Do not touch the evaporator with your hand when the appliance is operating.
- Do not attempt to repair or replace any part of your appliance unless this manual specifically recommends it. Have a qualified technician perform all other service on the unit.
- Children 8 years of age and older and people with reduced physical, sensory or mental capabilities or lack of experience and knowledge can use this appliance if they have been given supervision or instruction concerning use of the appliance in a safe way and they understand the hazards involved.
- Never allow children to operate, play with or crawl inside the appliance.
- Never allow children to clean and maintain the appliance without supervision.
- Do not use the appliance other than for its intended purpose.
- Do not touch the condenser surfaces. They are sharp and can be easily damaged.
- Do not use electrical appliances inside the food storage compartments of the appliance, unless they are of the type recommended by the manufacturer.

### **CLEANING AND MAINTENANCE PRECAUTIONS**

- Never clean the appliance parts with flammable fluids. Do not store or use gasoline or other flammable vapors and liquids in the vicinity of this appliance or any other appliances. The fumes can create a fire hazard or explosion.
- Do not use solvent-based cleaning agents or abrasives on the interior. These cleaners may transmit taste to the food, or damage or discolor the interior.
- If the appliance will not be used for a long time, thoroughly clean it before the next use. Carefully follow any instructions provided for cleaning or the use of sanitizing solution. Do not leave any solution inside the appliance after cleaning.
- Do not use mechanical devices or other means to accelerate the defrosting process, other than those recommended by the manufacturer.
- Do not damage the refrigerant circuit.

***THE MANUFACTURER DISCLAIMS ANY RESPONSIBILITY IF THE ABOVE INSTRUCTIONS ARE NOT FOLLOWED.***

# 2

## SPECIFICATIONS

### SAPPHIRE 24-INCH INDOOR BEVERAGE CENTER

FEATURES	24-INCH INDOOR BEVERAGE CENTER	24-INCH ADA HEIGHT BEVERAGE CENTER
Electrical Requirement	115V/60Hz	
Maximum Amp Fuse	15 amp	
Net Capacity	5.1 cu-ft (143 L)	4.7 cu-ft (132 L)
Temperature Setting	34° - 65°F (1° - 18°C)	

# 3

## INSTALLING THE UNIT

### WARNING

#### Fire/Explosion Hazard

**DO NOT install in spaces containing gasoline engines, fuel tanks or fuel line fittings. This device does not meet federal requirement for ignition protection.**

#### IMPORTANT:

##### Electrical Tips

- This appliance must be installed with all electrical connections in accordance with state and local codes.
- This unit requires a standard electrical supply properly grounded in accordance with National Electrical Code and local codes and ordinances.
- The fuse (or circuit breaker) size should be 15 amperes for 110V.
- The manufacturer recommends that you provide a separate circuit that services only your appliance. Use receptacles that cannot be turned off by a switch or pull chain.
- Plug the appliance into a grounded three-prong outlet. Do not remove the grounding prong, do not use an adapter, and do not use an extension cord.
- Do not kink, pinch or damage the power supply cord between the appliance and wall or cabinet.
- Before connecting the appliance to the power source, let it stand upright for approximately 4 hours. Following this step will reduce the possibility of a malfunction in the cooling system brought on by handling during transportation.
- Make sure to install the unit on a level surface.

##### Tips on Moving and Setting up the Unit

### CAUTION

#### Tip Hazard

**Be sure to use caution when working around an uninstalled unit. The unit is capable of tipping over if it is not installed and properly anchored.**

- Use two or more people to move and install the appliance. Failure to do so can result in back or other injury.
- Remove the packing materials and clean the appliance before using it.



## Factors Affecting the Unit

**NOTE:** Do not use an appliance intended for indoor use outside. Only use an appliance that is intended for outdoor use outdoors.

- Never keep the appliance next to ovens, grills or other high-heat resources.
- Keep the appliance on a hard, level surface that can support the unit when the unit is full. Keep the appliance level to help ensure it works properly. You may need to make several adjustments to level the unit. If necessary, adjust the height of the appliance by turning the feet. See “Leveling the Unit” on page 11.
- To ensure proper service access and ventilation, all SAPPHIRE units should not have the grill openings covered. There are no additional requirements for venting at the top, side or rear of the unit.
- These units are to be installed under a counter. Follow the recommended spacing dimensions listed in this manual. Place the electrical supply in the recommended location.

## REQUIRED CABINET OPENING

### WARNING

#### Fire/Explosion Hazard

**DO NOT** install in spaces containing gasoline engines, fuel tanks or fuel line fittings. This device does not meet federal requirement for ignition protection. Failure to comply could result in injury or death.

A built-in installation will allow you to install the appliance under a counter or in a kitchen cabinet if you respect the required clearance space around the appliance. The appliance must be located to allow clearance for the electrical connection in the rear of the unit.

## BUILT-IN CABINET DIMENSIONS

A built-in unit is designed for zero clearance at the top and each side of the unit. The unit uses fan-forced condenser cooling, which requires air circulation through the lower section of the unit.

**NOTE:** To ensure proper service access and ventilation, all SAPPHIRE units should not have the grill openings covered. There are no additional requirements for venting at the top, side or rear of the unit.

## SAPPHIRE 24-INCH INDOOR CABINET DIMENSIONS

Recommended location for electrical connection in either adjacent cabinet.

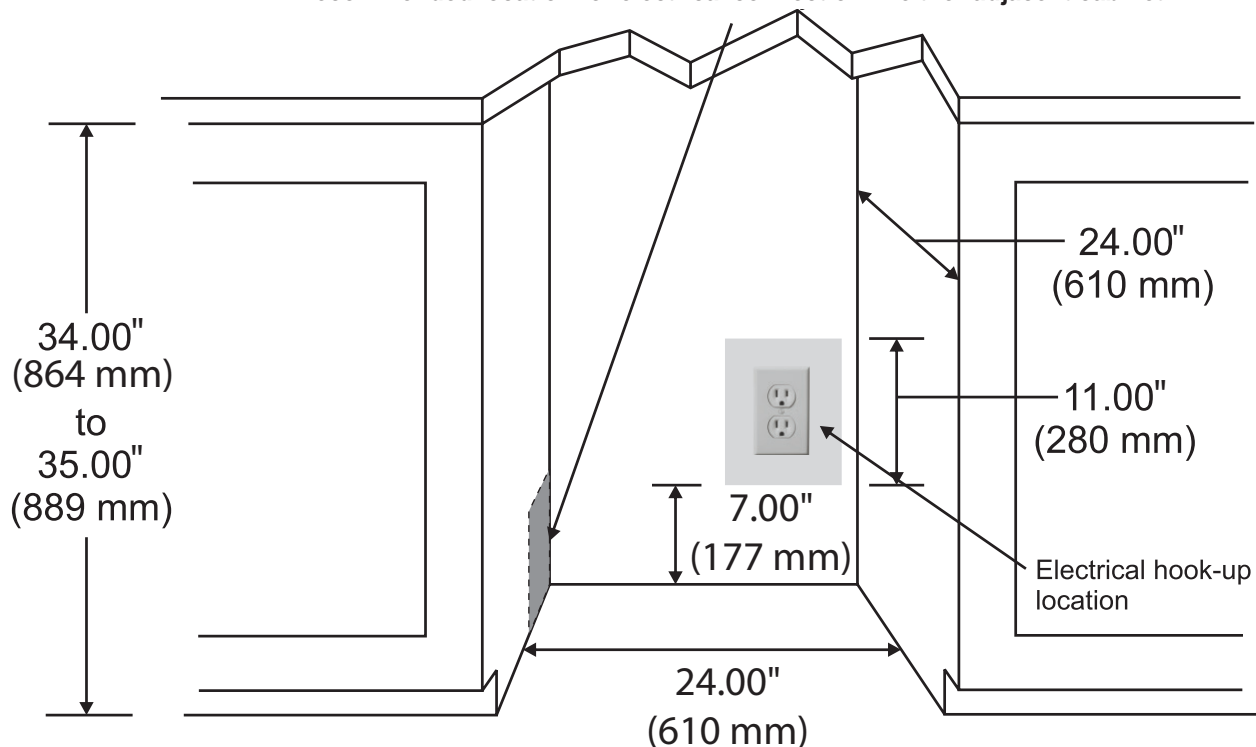

## SAPPHIRE 24-INCH ADA HEIGHT-COMPLIANT BUILT-IN CABINET DIMENSIONS

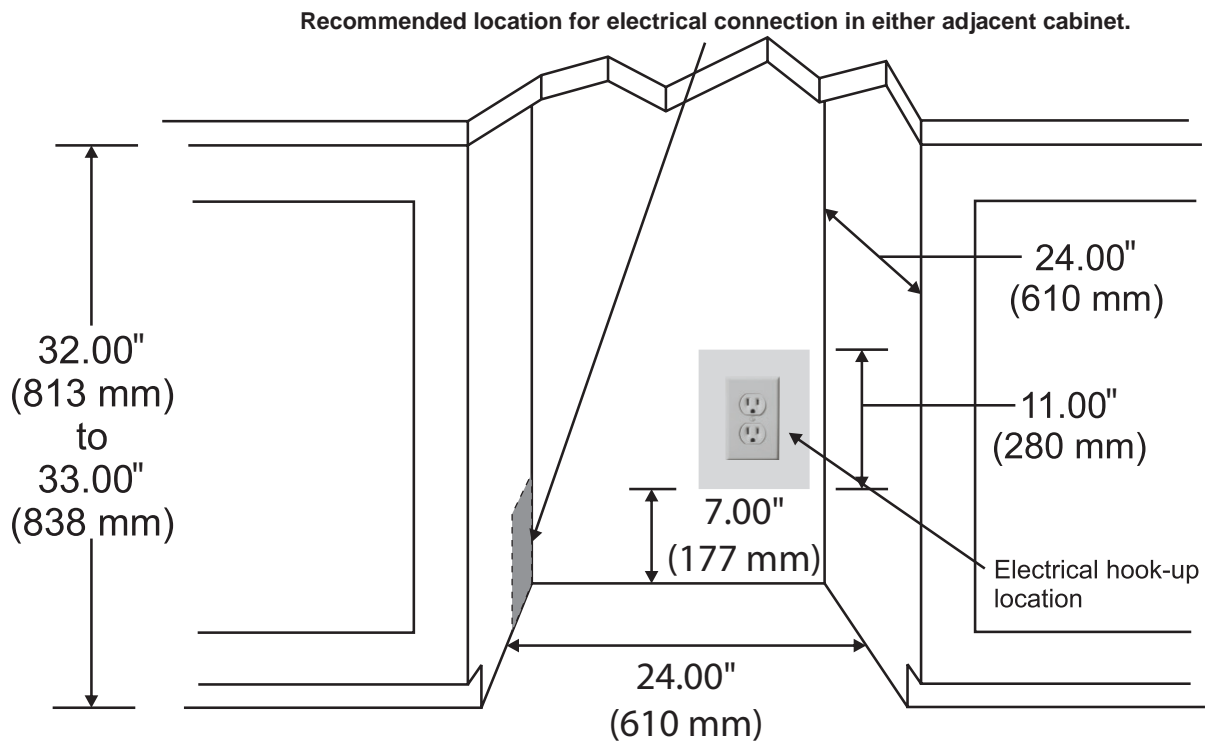

### NOTICE

- If you remove the rubber feet from the bottom of the unit, reinstall the mounting screws into the bottom of the cabinet to avoid damage to components mounted to the base pan.
- Ensure that the air path for the grill remains unrestricted. Any restriction of airflow through the grill will disrupt normal operation of the unit, resulting in damage to components, and voids warranty.
- The minimum distance the unit needs to be installed when adjacent to a wall is 11.0 in. (280 mm) which is required to obtain full swing (135°) of the door and 2.75 in. (70 mm) when using the 90° pin (provided) to restrict the swing of the door. This distance can help you make sure the handle does not hit the wall.

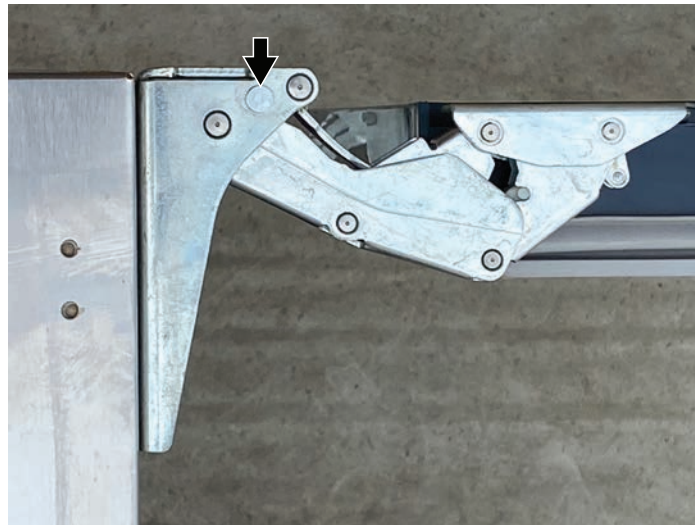

### ELECTRICAL CONNECTION

Do not, under any circumstances, cut or remove the third (ground) prong from the power cord.

For personal safety, you must properly ground this appliance. The power cord of this appliance features a three-prong grounding plug that mates with a standard three-prong grounding wall outlet to minimize the possibility of electric shock hazard from the appliance. Have a qualified electrician check the wall outlet and circuit to make sure the outlet is properly grounded. It is your responsibility and obligation to have a standard two-prong wall outlet replaced with a properly grounded three-prong wall outlet.

Always plug the appliance into its own individual electrical outlet. The voltage rating of the outlet must match the rating label on the appliance. This match provides the best performance and also prevents overloading the electrical circuits, which could cause a fire hazard from overheated wires.

Never unplug your appliance by pulling on the power cord. Always grip the plug firmly and pull straight out from the outlet.

Repair or replace immediately all power cords that have become frayed or damaged. Do not use a cord that shows cracks or abrasion damage along its length or at either end.

When moving the appliance, take care not to damage the power cord.

If the supply cord suffers damage, have the manufacturer, its service agent, or similarly qualified persons replace the supply cord to avoid a hazard.

## AVOIDING USE OF EXTENSION CORDS

Because of potential safety hazards under certain conditions, the manufacturer strongly recommends that you do not use an extension cord with this appliance.

## LEVELING THE UNIT

The appliance requires leveling before it can work properly. If necessary, raise or lower the unit by turning the four leveling feet on the bottom. The manufacturer recommends using a carpenter's level to check the appliance.

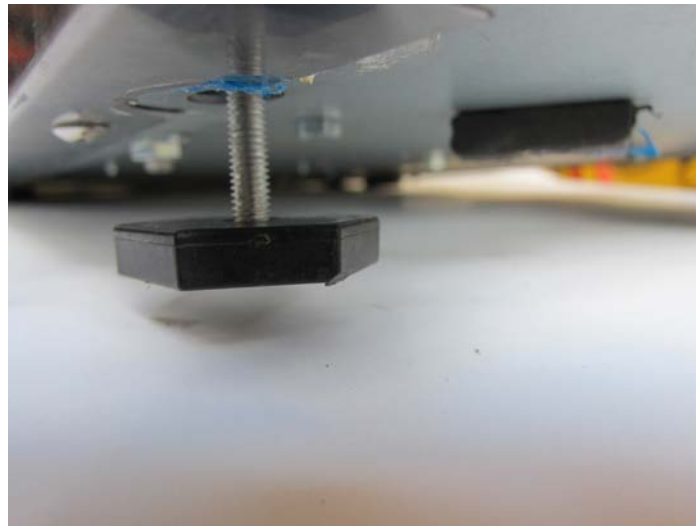

### NOTICE

It is extremely important that the appliance is level for optimum performance.

Adjust all four leveling feet evenly so that the top of the appliance is at the desired installation height and is level.

1. On a level surface, place a carpenter's level on top of the appliance to see if it is level from front to back and side to side.
2. Adjust the height of the leveling feet as follows:
  - Turn the leveling feet to the right to lower that side of the appliance.
  - Turn the leveling feet to the left to raise that side of the appliance.

### REVERSING THE DOOR

This appliance has the capability of the door opening from either the left or right side. The appliance is delivered to you with the door opening from the left side. Follow these instructions should you desire to reverse the opening direction:

1. Check the power cord and make sure it is not plugged into the outlet.
2. Carefully remove the two plugs at the top and bottom of the left side of the appliance. Save the plugs.



3. Loosen but do not remove the outer top and bottom screws on the right-side hinge.



4. Remove the inner top and bottom right-side hinge screws. Install these screws about three turns in the left-side outer top and bottom screw locations.



5. Lift the door off the partially loosened right-side screws. Rotate the door and position it on the two partially installed left-side screws.
6. Finish removing the outer top and bottom screws from the right-side hinges. Install these screws in the open holes in the left-side hinge location. Tighten all screws.



7. Install the plugs into the four open holes on the right side.

## CUSTOM DOOR PANEL

A custom door panel/frame can be fabricated for the appliance. Handle hardware must also be provided, if needed.

**NOTE:** Do not cover a glass door with a solid panel.

Finish all sides of the custom panel. They may be visible when the door is open.

### 24-INCH INDOOR FULL-SIZE DOORFRAME

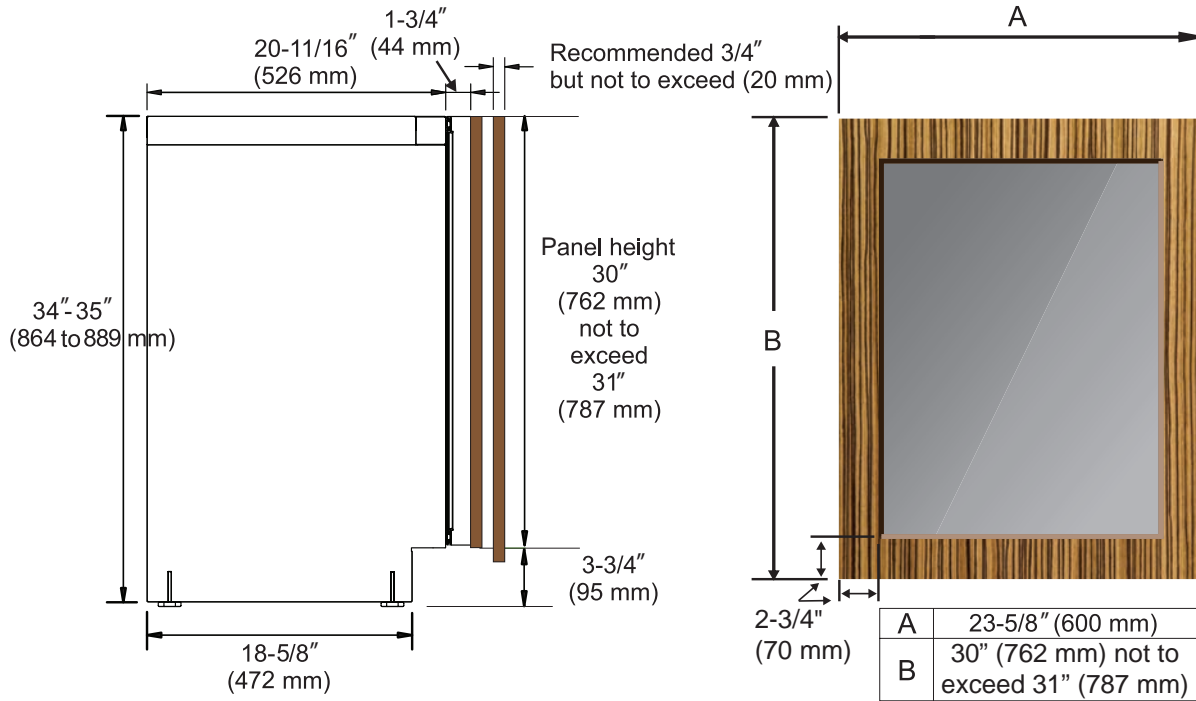

### 24-INCH ADA HEIGHT-COMPLIANT DOORFRAME

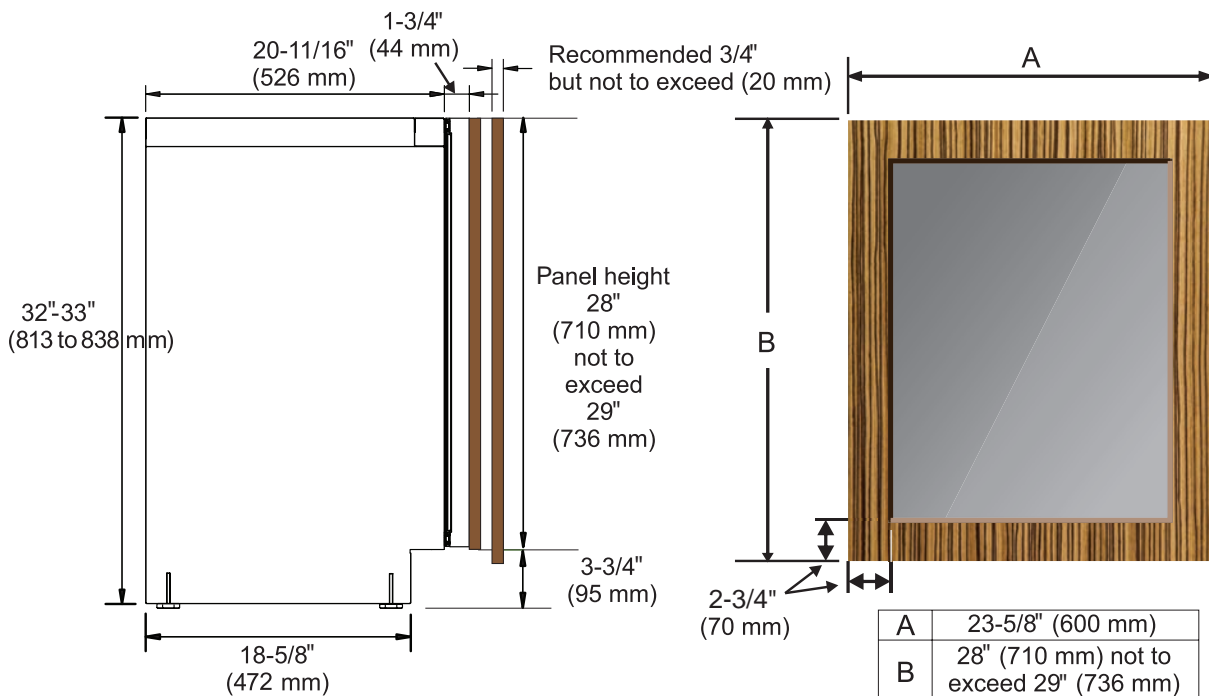



## INSTALLING THE CUSTOM DOOR PANEL

1. Remove the door from the unit.
2. Remove the door seal to gain access to the custom door panel mounting holes.



3. Align the top of the custom door panel flush with the top of the door.
4. Adjust the overlap of the custom door panel so it is equal on both sides of the door.
5. Secure the custom door panel to the door using six wood screws (provided).

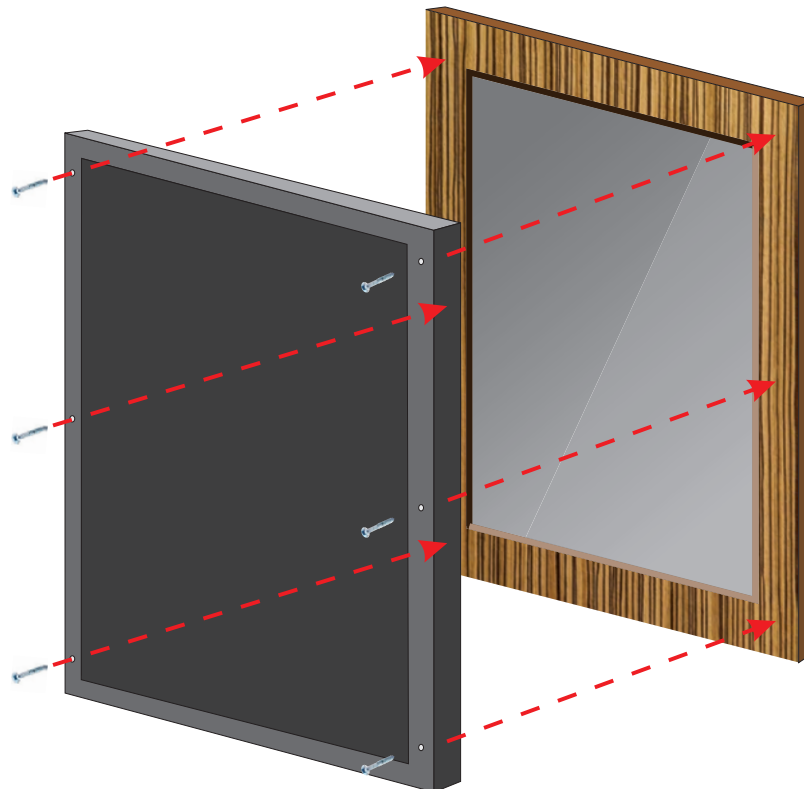

6. Reinstall the door seal. Be sure the seal is properly seated.
7. Reinstall the door to the unit.

### ANTI-TIP SYSTEM

1. On built-in installations, once the appliance is in place and leveled, secure the two anti-tip brackets underneath the countertop using two screws (provided).
2. If the brackets for the anti-tip system cannot be secured above the appliance and no wood is available, the brackets for the anti-tip system can be relocated to the side of the appliance for securing into an adjacent cabinet.

### INTEGRATED GRILL/PLINTH

1. An integrated grill/plinth can be fabricated if desired. The thickness of the panel should be between 1/4 in. to 3/8 in. (6 mm to 9 mm) and the height will vary between 3-5/16 in. to 4-5/16 in. (84 mm to 110 mm) depending on your grill/plinth height.

**NOTE:** When finishing the grill/plinth, be sure to stain the front, back and all edges to prevent warping.

2. Apply double-sided tape to the surrounding edges of the integrated grill/plinth.
3. Remove the backing paper from the double-sided tape. Carefully align the grill/plinth over the integrated grill/plinth and press it into position.

# 4 | OPERATING THE UNIT

## USING THE CONTROLS

The control panel is located at the top of the appliance.

**NOTE:** You have 30 seconds to make a control change before the display reverts to the default screen.

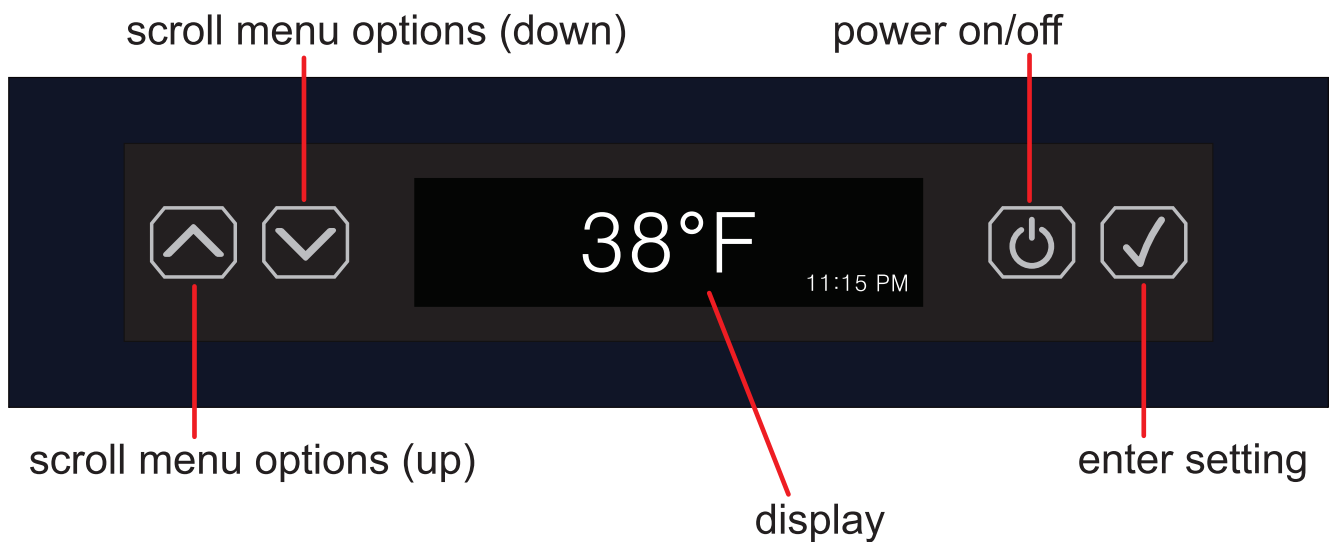

**NOTE:** The clock time only displays if the user has set the NIGHTLIGHT function; otherwise the clock time does not appear on the screen.

## TURNING THE UNIT ON

1. Press the ON/OFF button (⏻).



2. The refrigerator powers up and displays the default temperature screen.

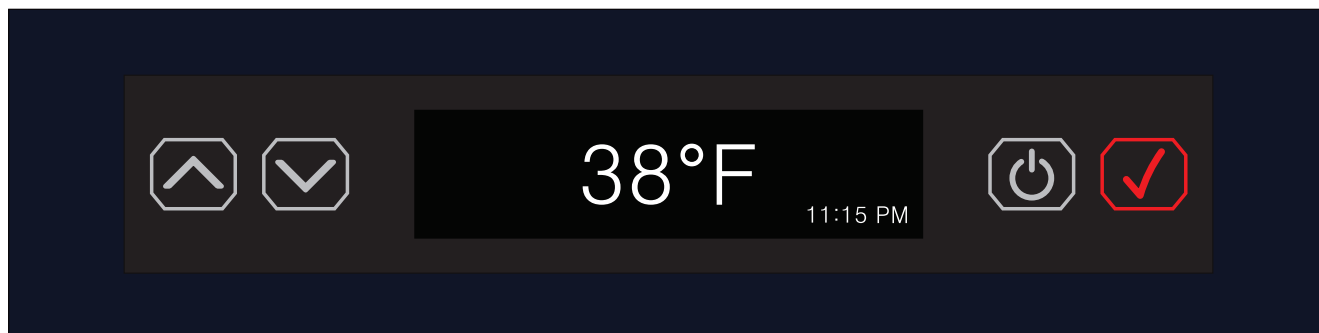

**NOTE:** The factory default temperature must be 38°F.

### TURNING THE UNIT OFF

1. Press the ON/OFF button (  ) and hold for 3 seconds.

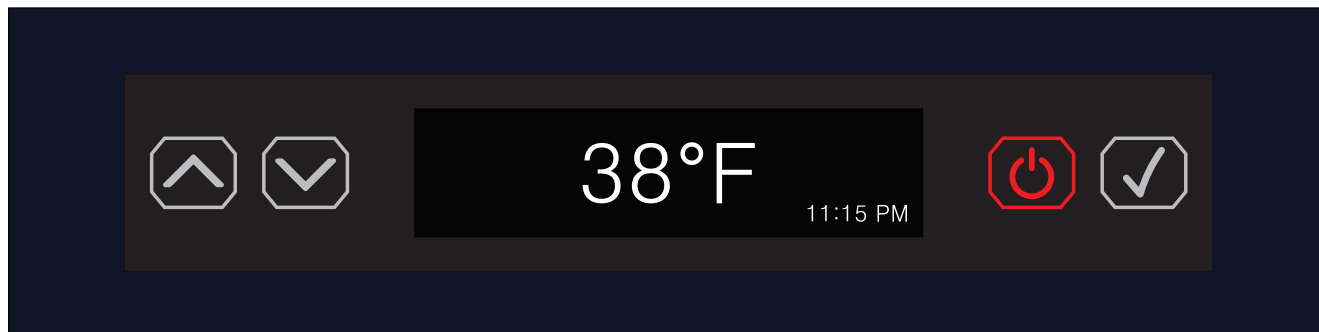

2. The refrigerator powers off and nothing displays.



## ENTERING THE DISPLAY OF MENU ITEMS

1. To enter the menu of settings, press the ENTER button ( ✓ ).

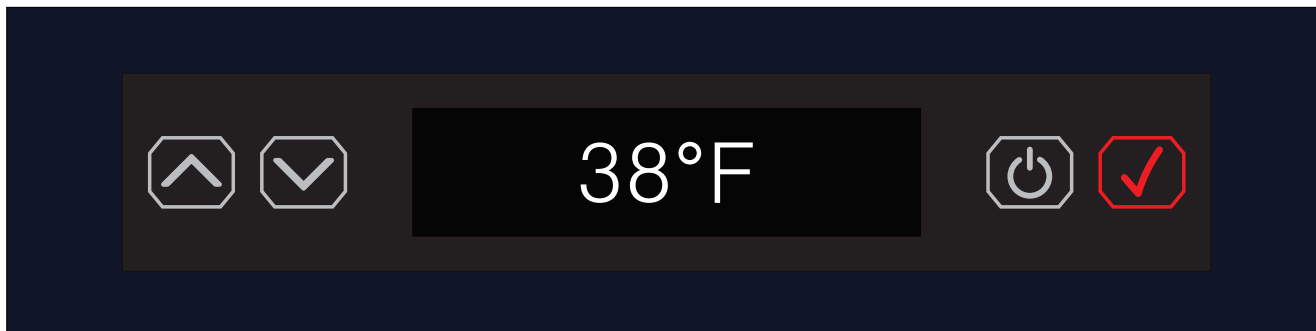

2. The display shows the first menu item, LIGHTING OPTIONS.

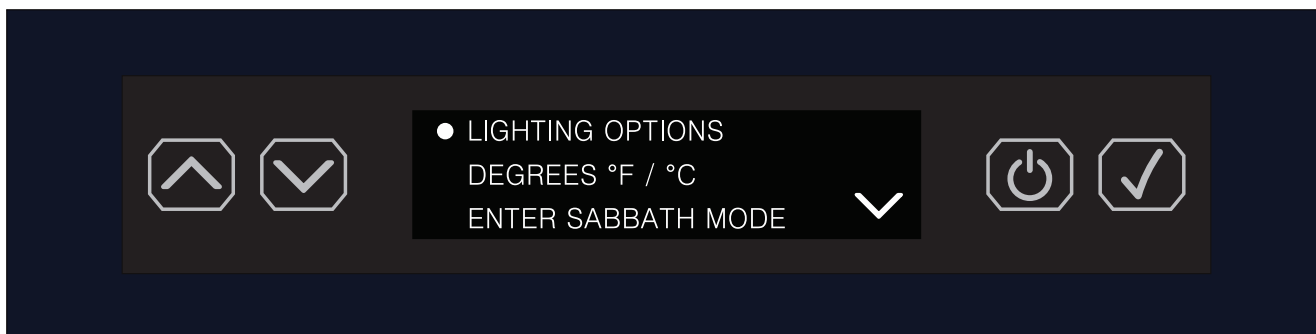

3. Scroll to the next menu item by pressing the DOWN ARROW button ( ✓ ).

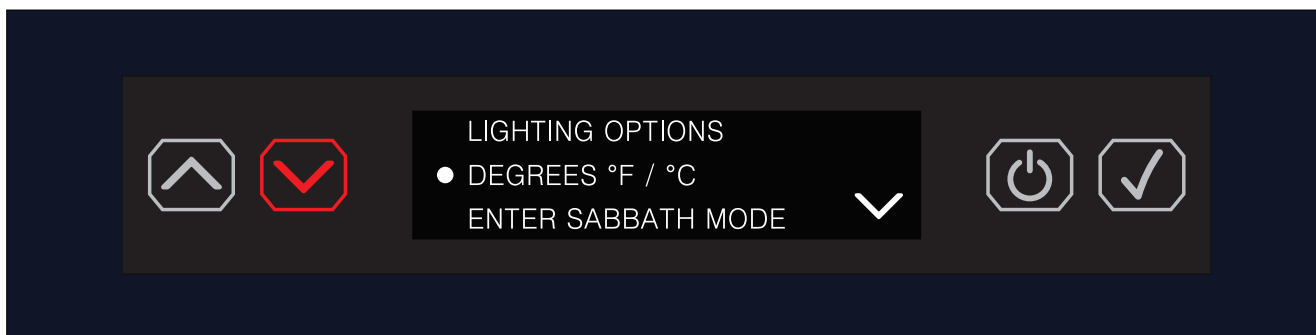

4. Scroll to the next menu item by pressing the DOWN ARROW button ( ✓ ).

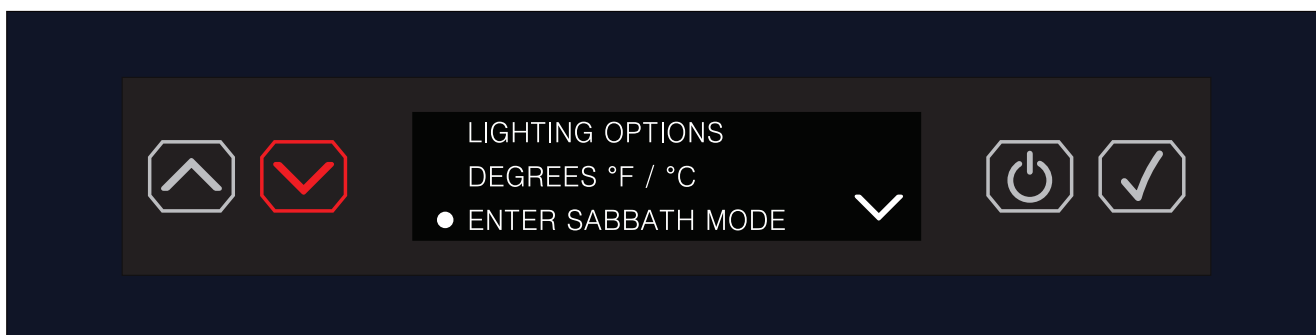

5. Scroll to the next menu item by pressing the DOWN ARROW button (  ).

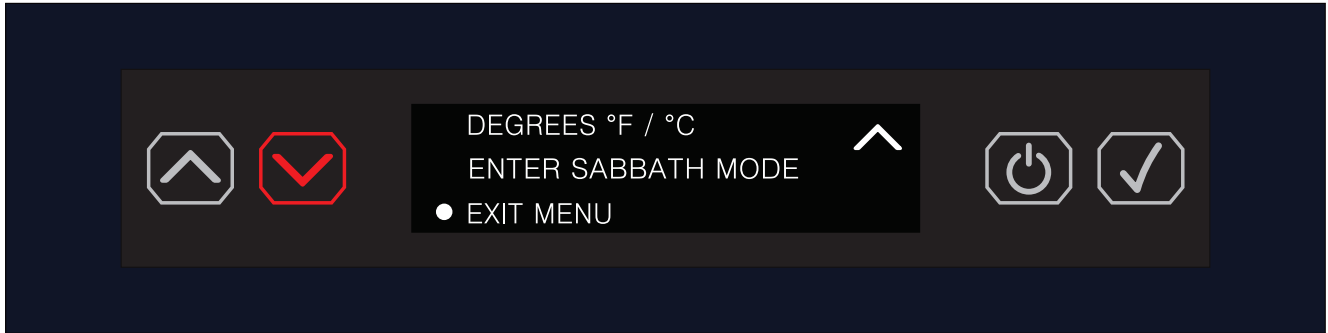

6. To exit the menu, press the ENTER button (  ).

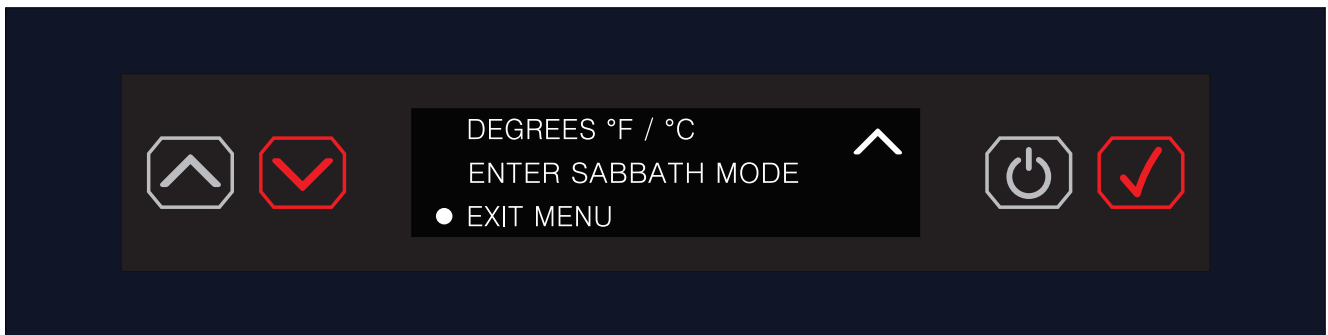

**NOTE:** Once you select a menu item, the system takes you directly to that particular setting.

### LIGHTING OPTIONS

1. To adjust the lighting, press the ENTER button (  ) to access the menu.

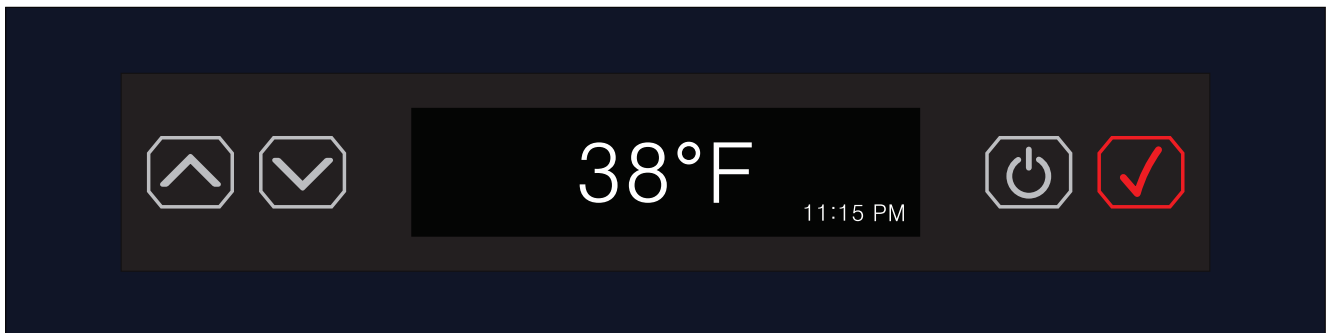

2. The first menu item is LIGHTING OPTIONS. Press the ENTER button (✓).

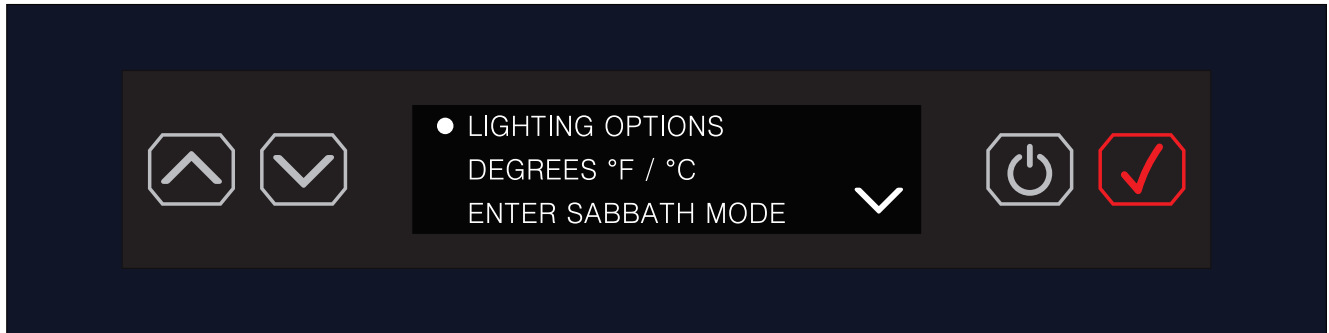

3. Press the DOWN arrow (✓) to reach the desired setting.

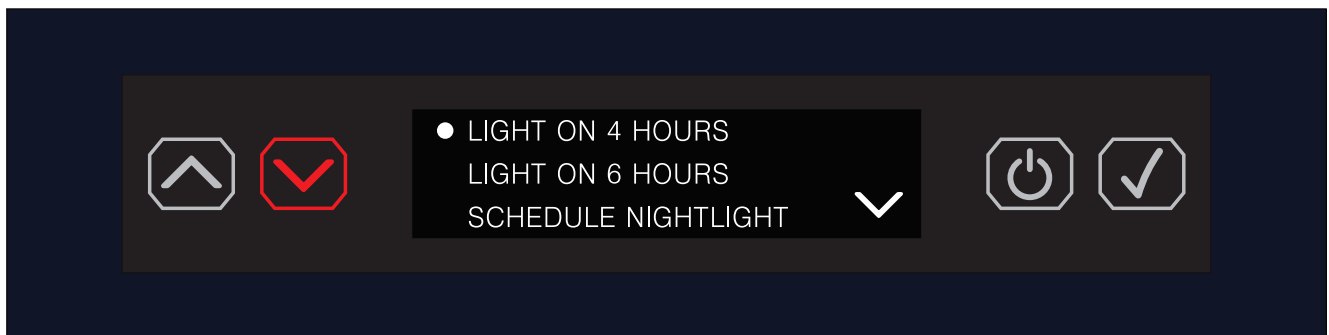

4. To return back to the main menu, scroll down by pressing the DOWN ARROW (✓) and then press the ENTER button (✓).

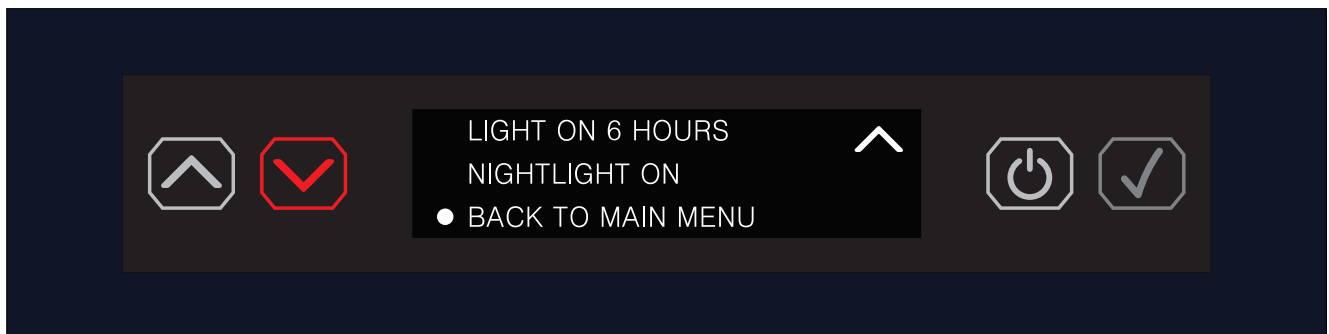

### LIGHTING OPTIONS - SCHEDULING NIGHTLIGHT

1. To schedule the nightlight setting, press the ENTER button (✓) to access the menu.

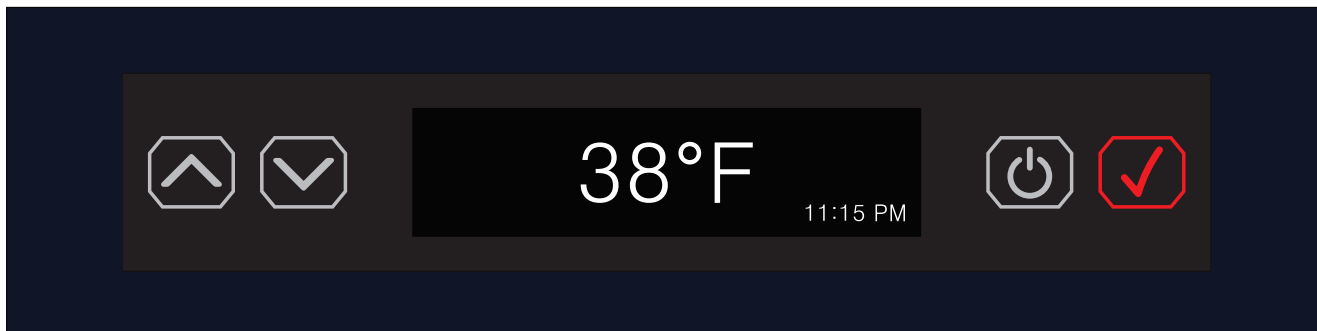

2. The first menu item is LIGHTING OPTIONS. Press the ENTER button (✓).

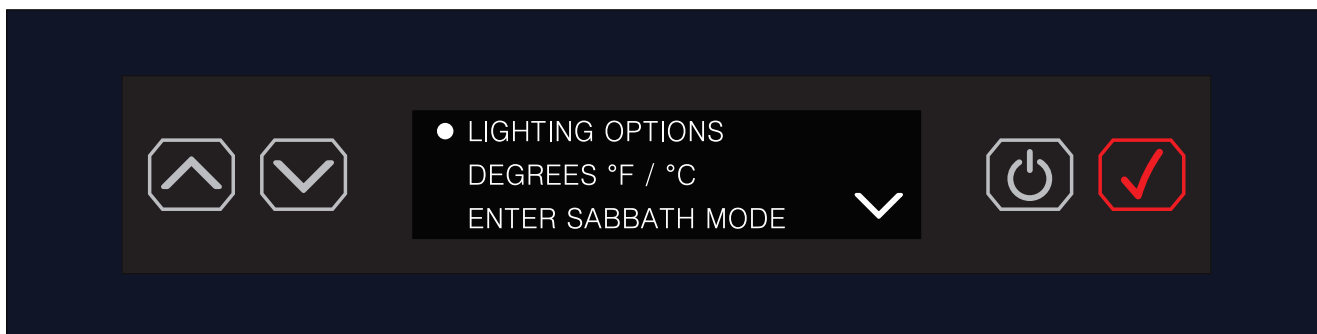

Press the DOWN ARROW (∨) to reach the SCHEDULE NIGHTLIGHT setting.

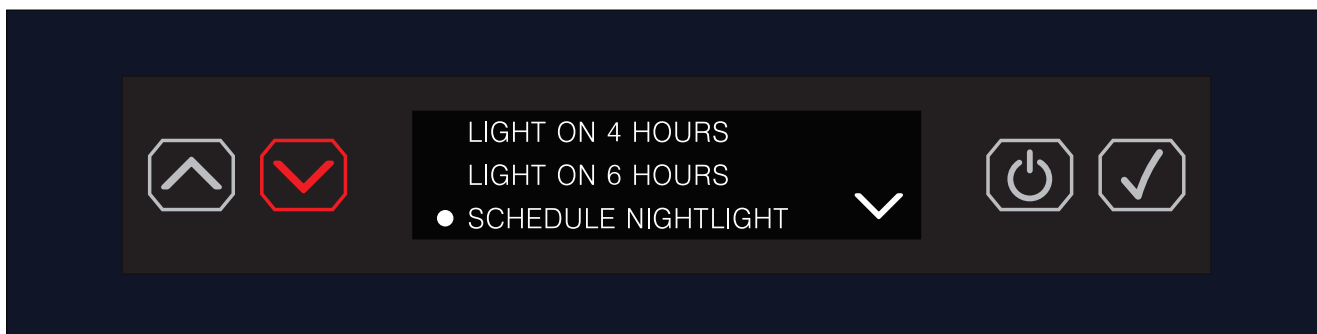

3. Set the clock time before reaching the desired SCHEDULE NIGHTLIGHT setting. Press the ENTER button (✓).

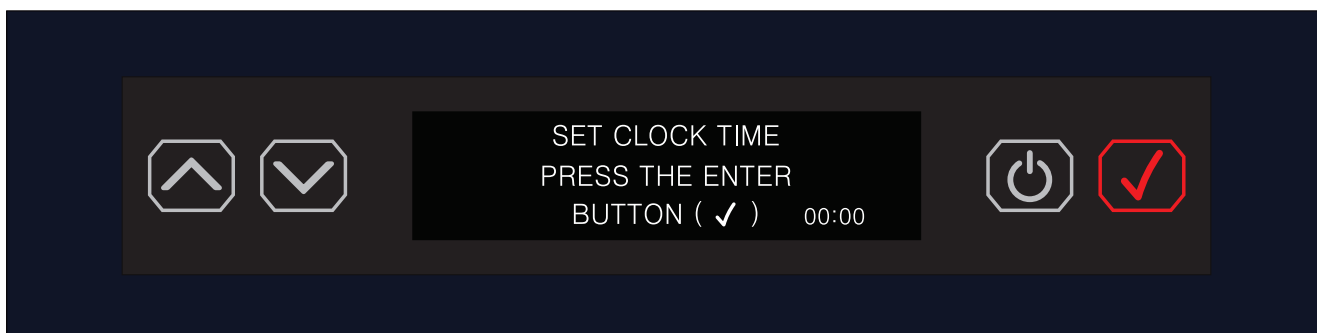



4. The display will show the clock at 00:00 and prompt you to set the hour.

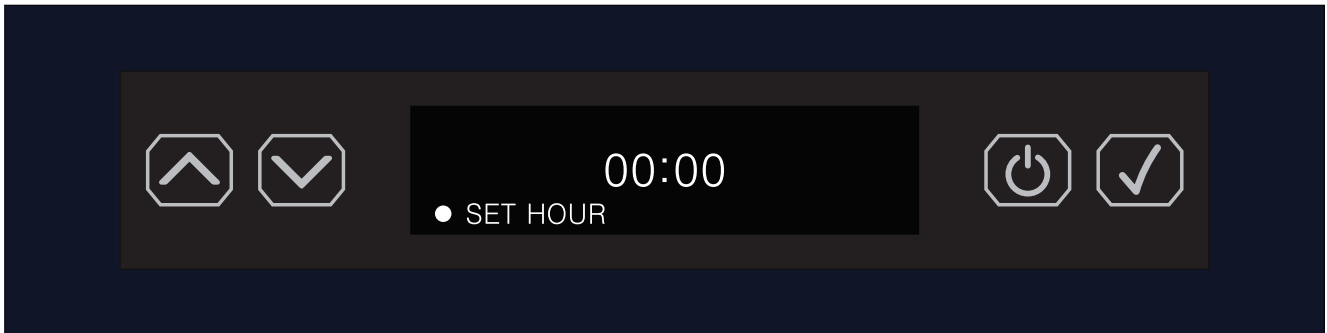

5. Set the hour using the UP / DOWN ARROW buttons.

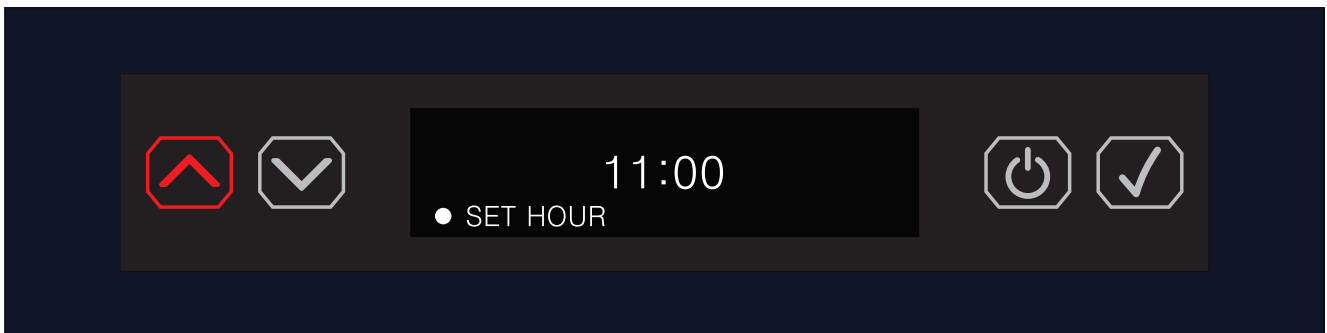

6. Once the hour is set, press the ENTER button (✓).

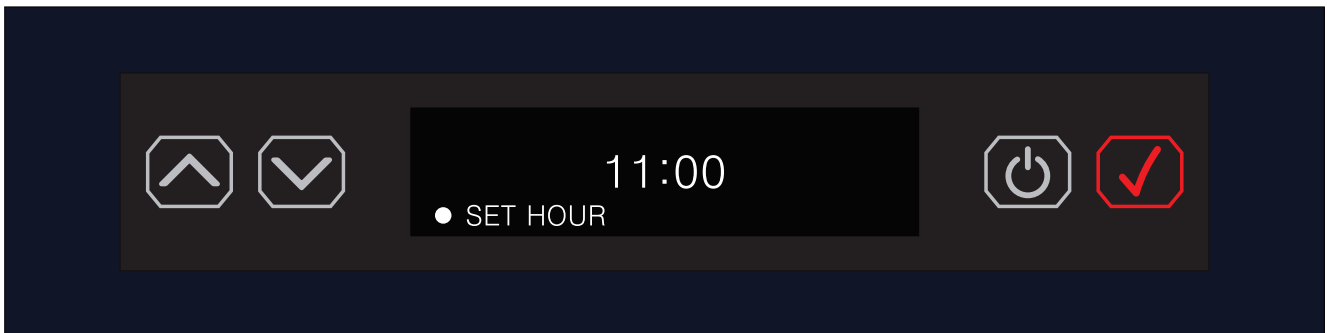

7. Set the minutes using the UP / DOWN ARROW buttons.

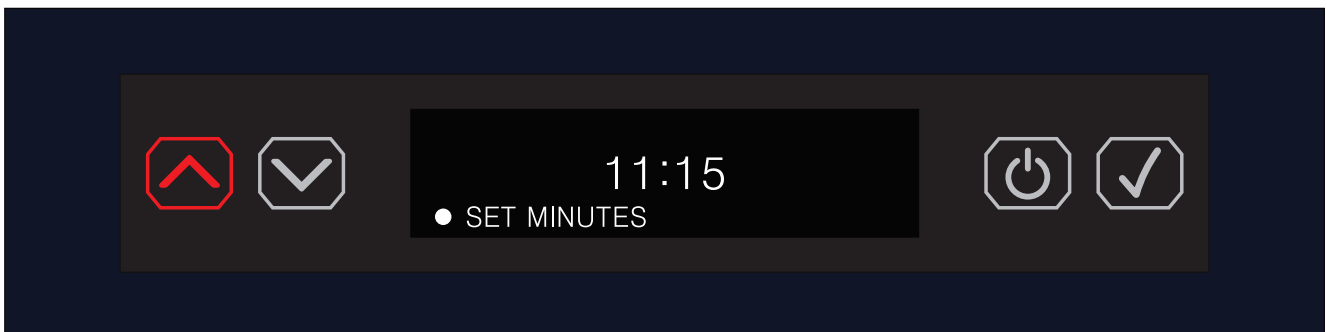

8. Once the minutes are set, press the ENTER button (✓).

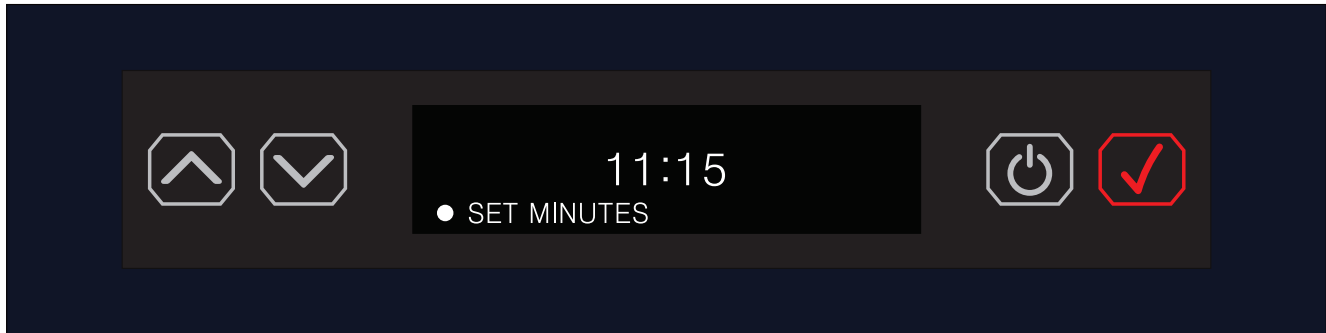

9. Select AM or PM using the UP / DOWN ARROW buttons.

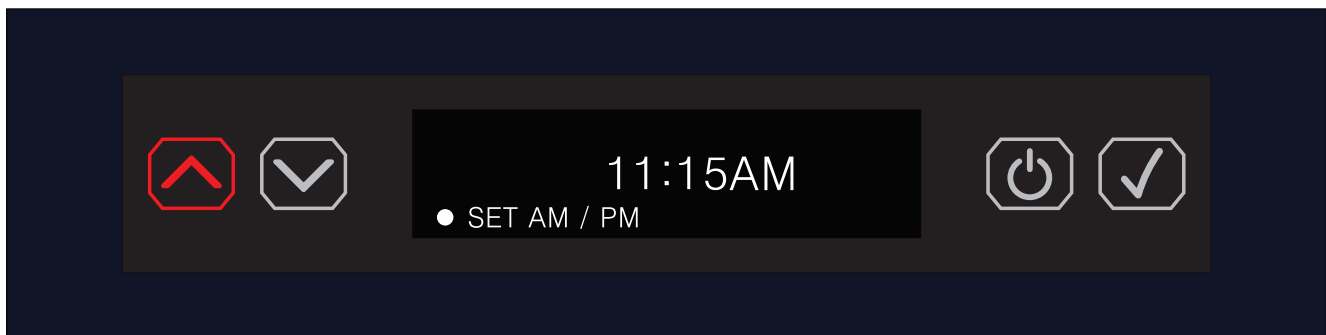

10. Once the AM / PM is set, press the ENTER button (✓).

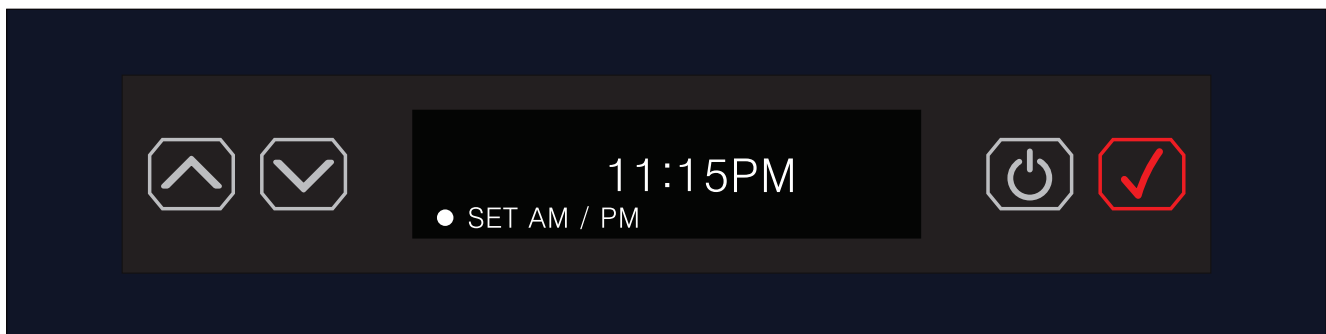

11. Once the time is properly set, set the START TIME HOUR for the SCHEDULE NIGHTLIGHT by pressing the UP or DOWN ARROW buttons.

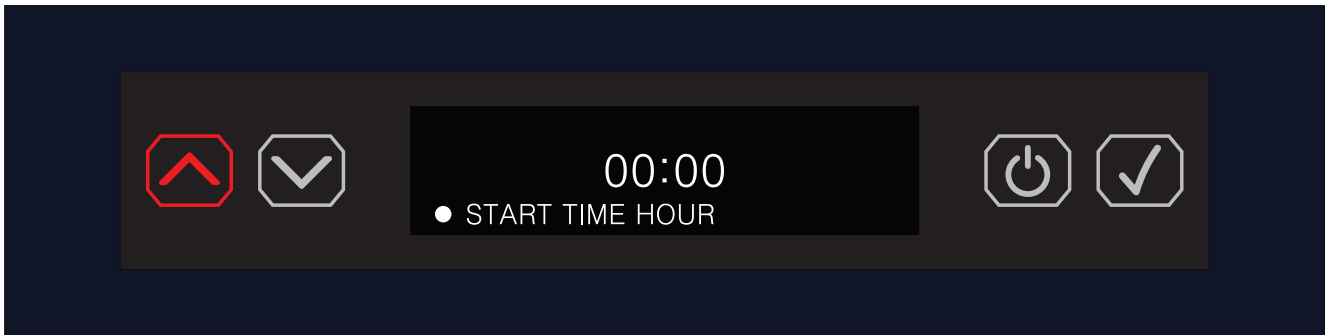

12. Using the UP / DOWN ARROW buttons, set the START TIME HOUR.

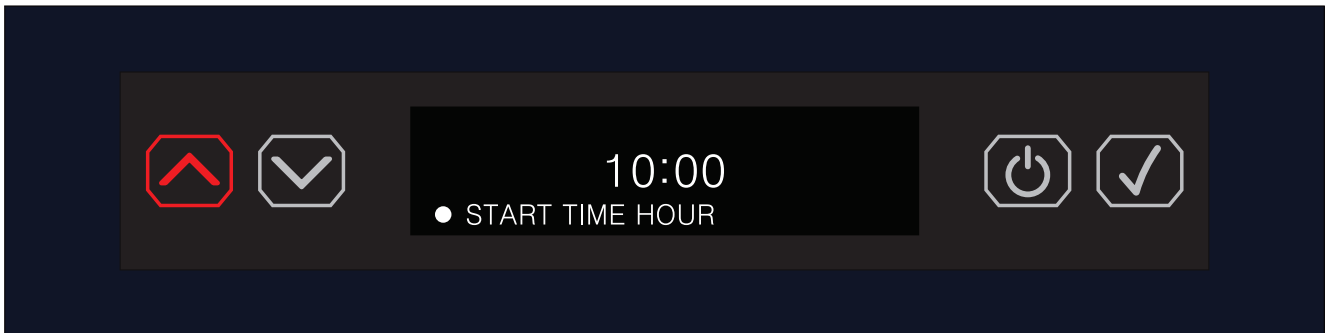

13. Once the hour is set, press the ENTER button (✓).

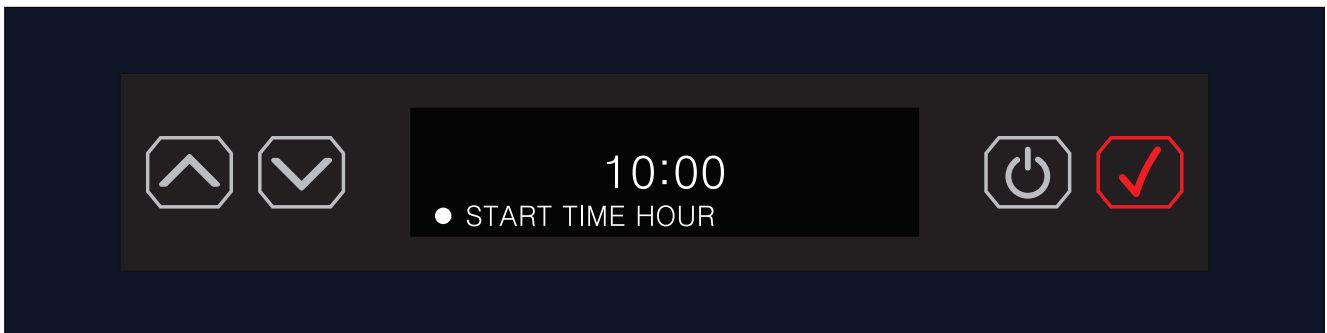

14. Using the UP / DOWN ARROW buttons, set the START TIME MINUTES.

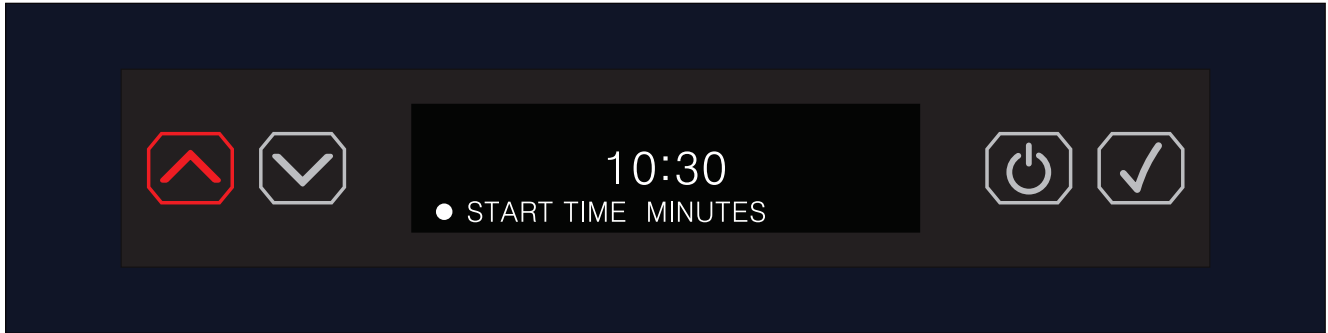

15. Once the minutes are set, press the ENTER button (✓).

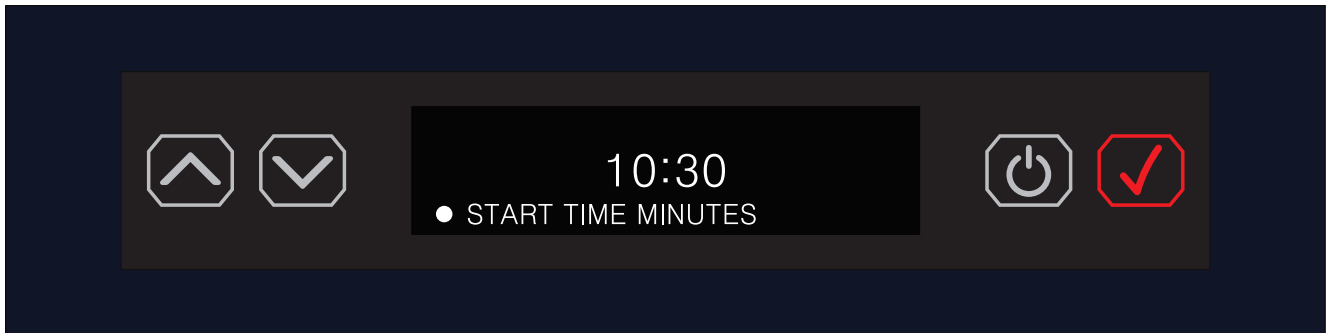

16. Using the UP / DOWN ARROW buttons, select START TIME AM / PM.

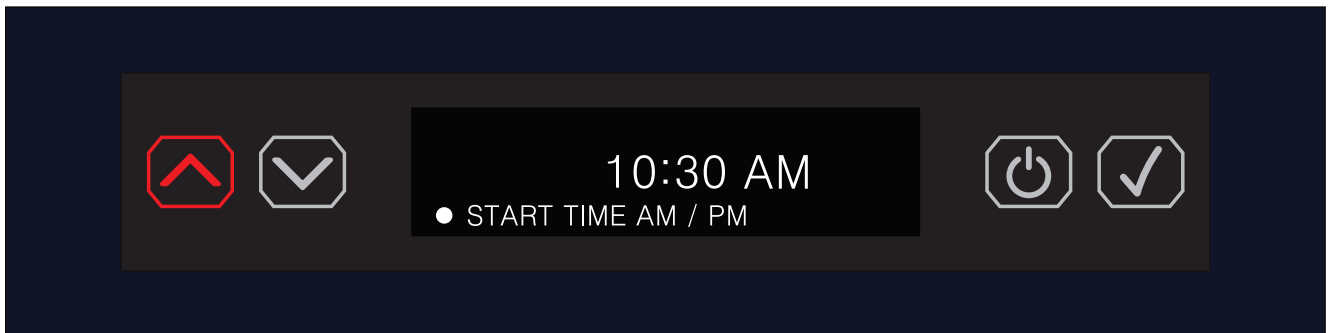

17. Once the AM / PM is set, press the ENTER button (✓).

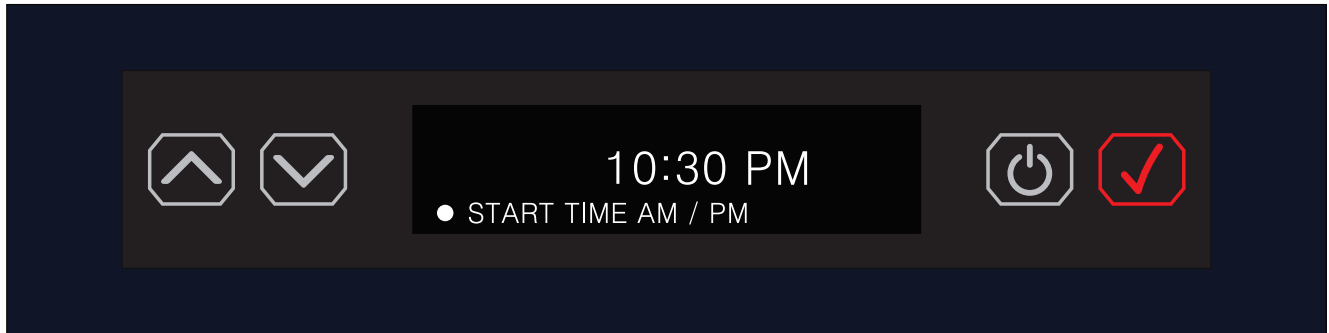

18. Once the start time is properly set, set the END TIME HOUR for the SCHEDULE NIGHTLIGHT by pressing the UP or DOWN ARROW buttons.

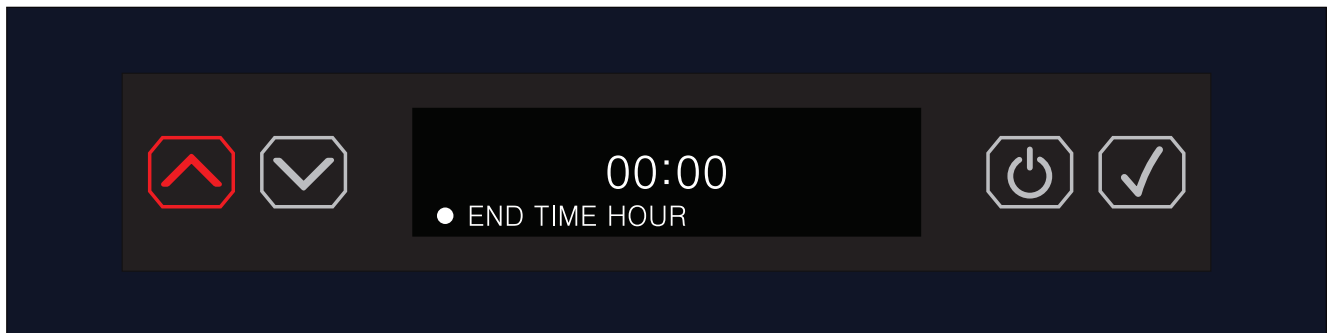

19. Using the UP / DOWN ARROW buttons, select the END TIME HOUR.

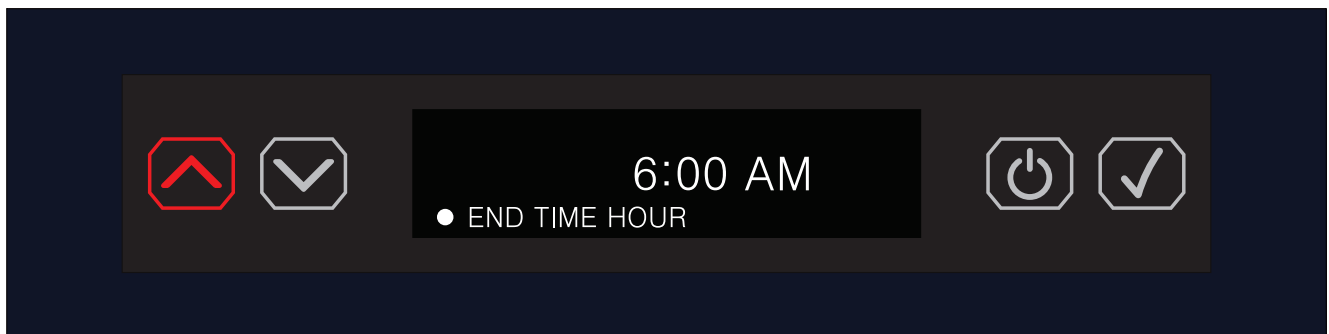

20. Once the hour is set, press the ENTER button (✓).

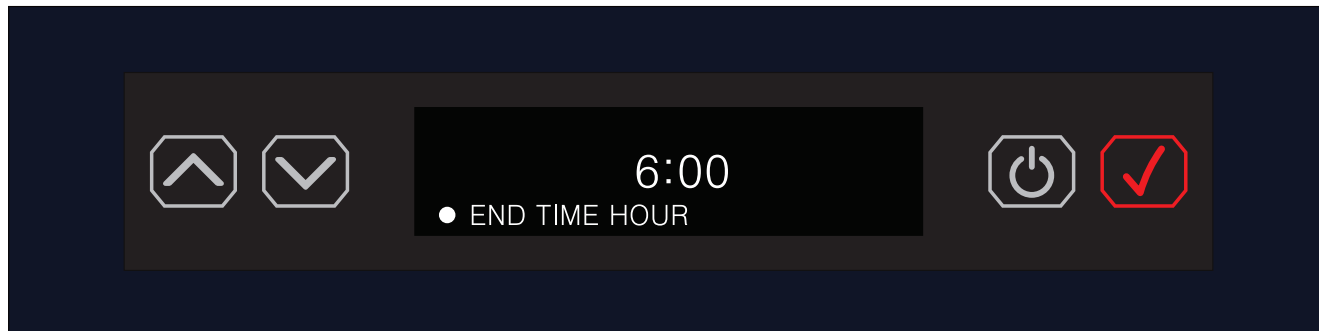

21. Using the UP / DOWN ARROW buttons, set the END TIME MINUTES.

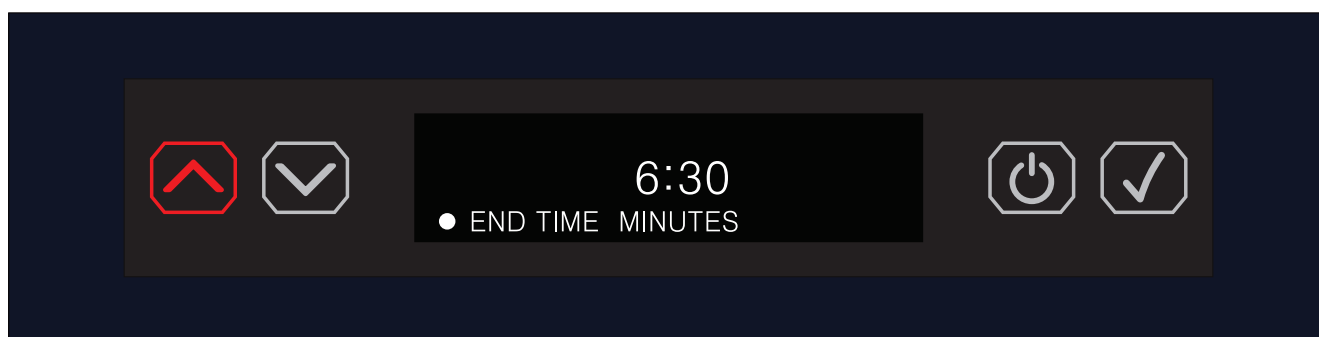

22. Once the minutes are set, press the ENTER button (✓).

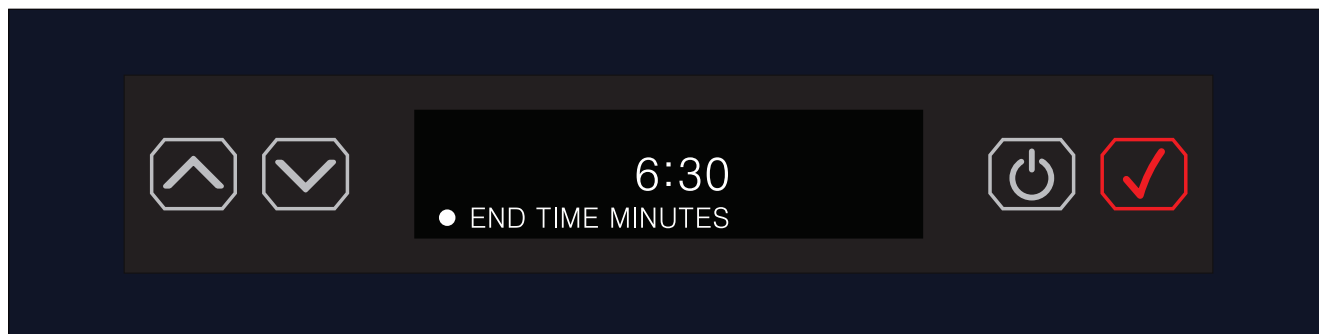

23. Using the UP / DOWN ARROW buttons, select END TIME AM / PM.

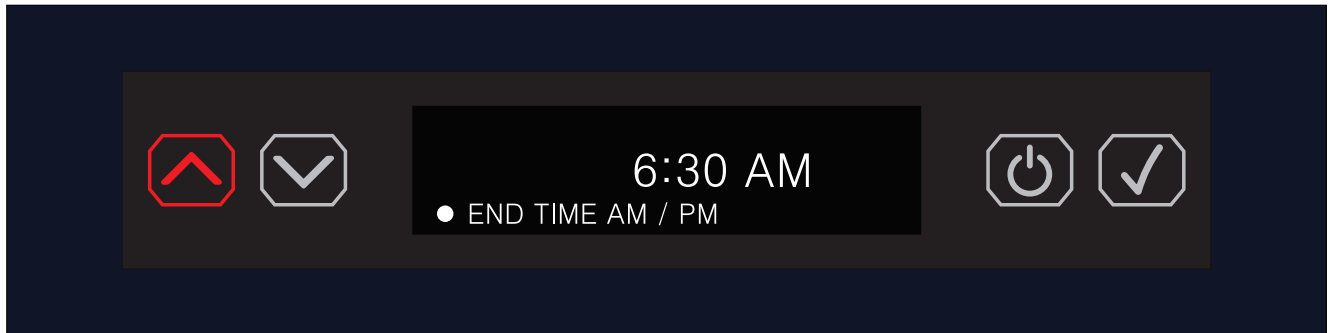

24. Once the AM / PM is set, press the ENTER button (✓).

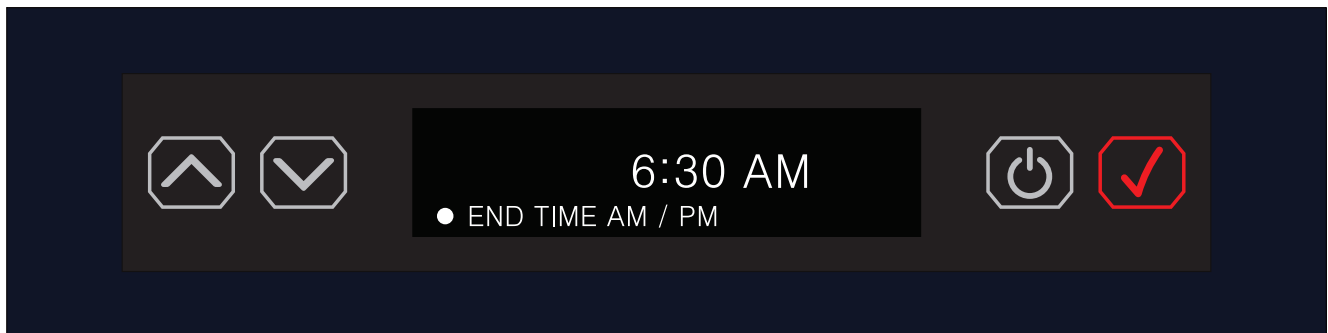

25. SCHEDULE NIGHTLIGHT is now set and the display will show the default temperature screen with the crescent moon icon and the time set.

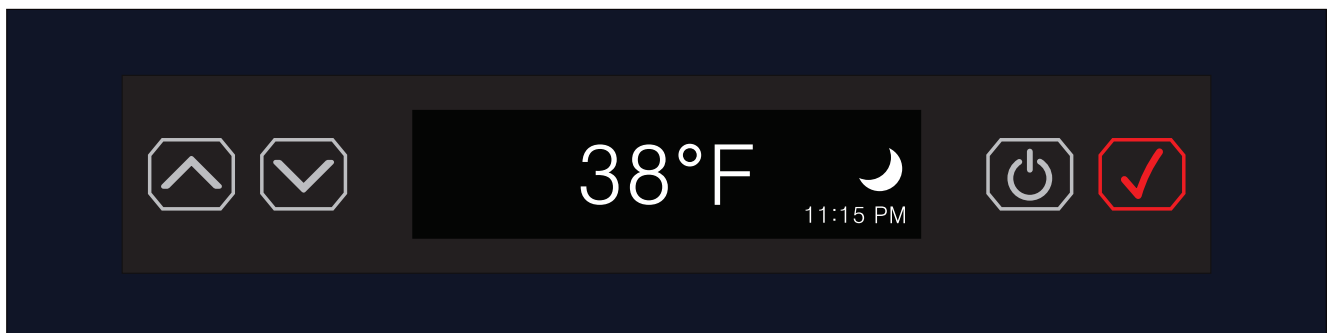

**NOTE:** The factory default lighting setting is DOOR OPEN ONLY.

### LIGHTING OPTIONS - TURNING NIGHTLIGHT OFF

1. To turn off the NIGHTLIGHT setting, press the ENTER button (✓) to access the menu.

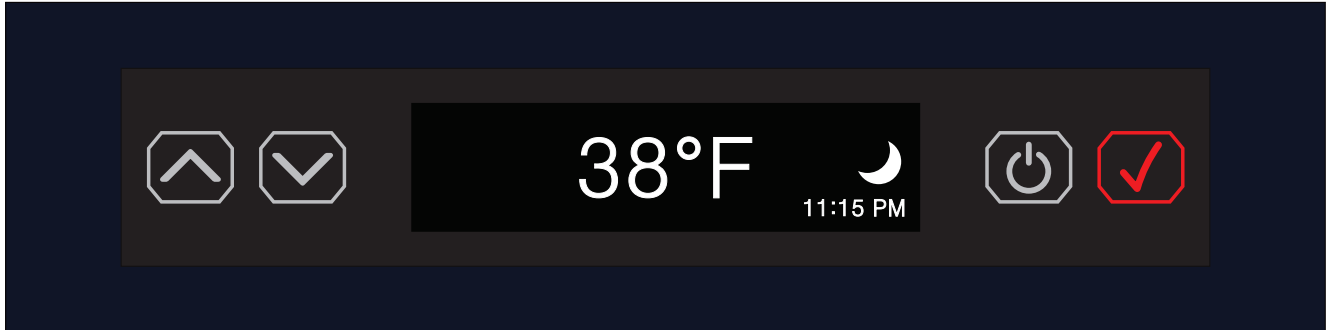

2. The first menu item is LIGHTING OPTIONS. Press the ENTER button (✓).

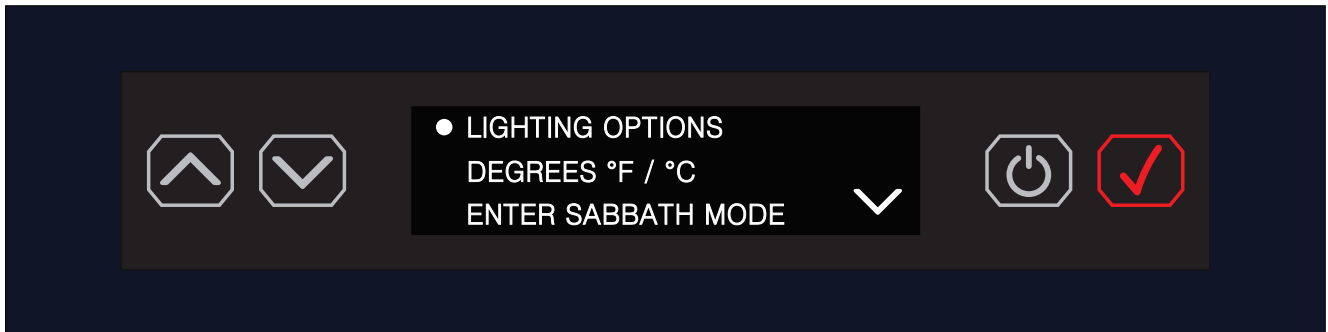

3. Press the DOWN ARROW button (∨) to reach the menu item TURN NIGHTLIGHT OFF.

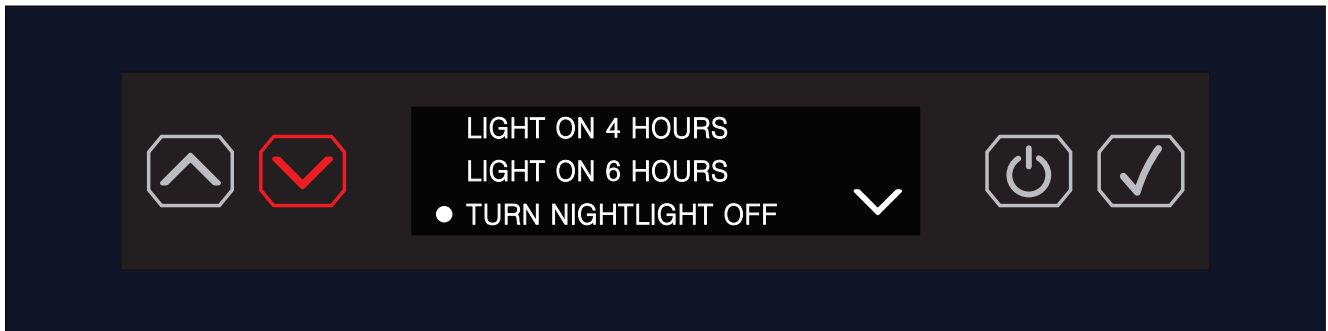

**NOTE:** The NIGHTLIGHT setting will remain on until user turns it off.



4. To confirm the setting, press the ENTER button (✓).

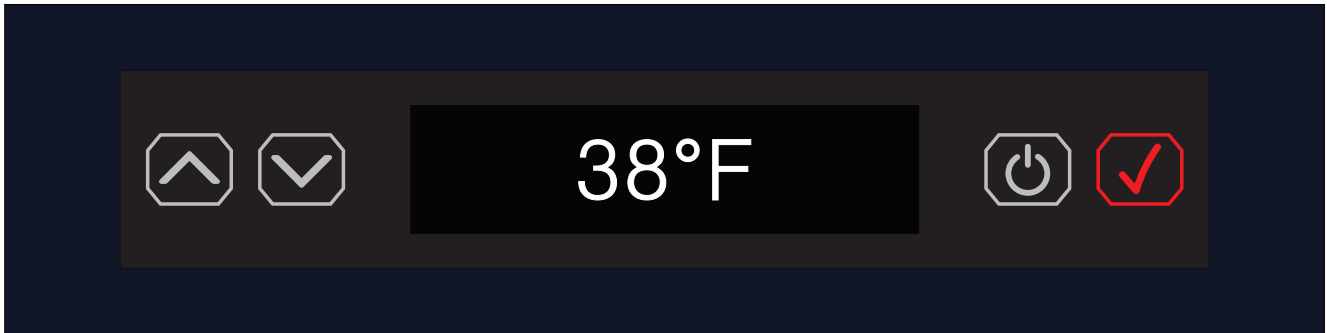

## SETTING TEMPERATURE

1. To set the temperature, press the ENTER button (✓).

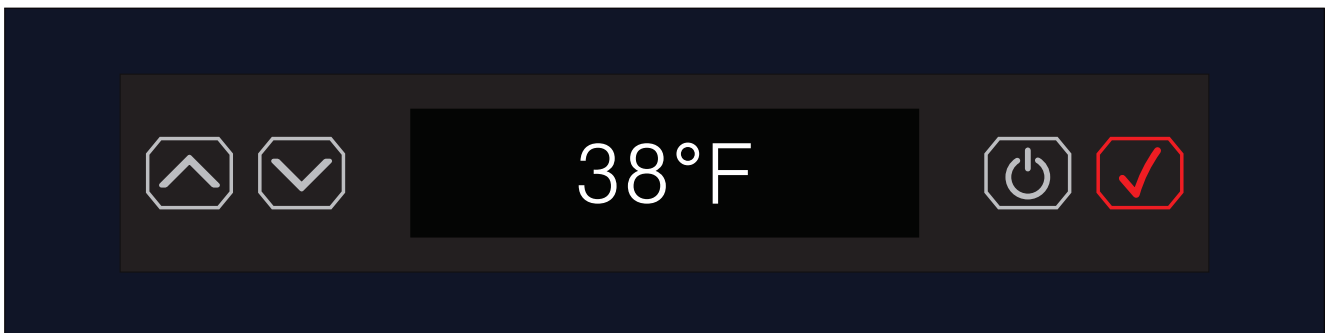

2. Press the DOWN ARROW button (▼) to the item DEGREES °F / °C and then press the ENTER button (✓).



3. Press the DOWN ARROW button (  ) to reach the desired setting.

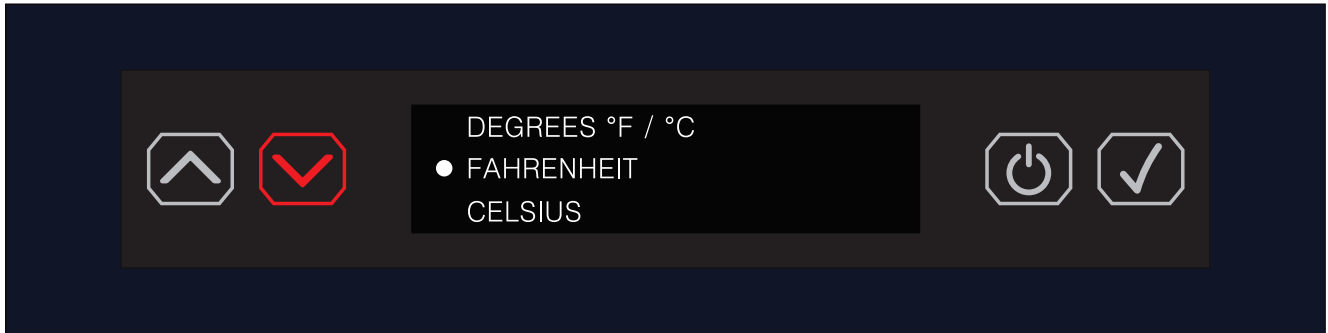

4. The default unit setting is DEGREES FAHRENHEIT (°F). To maintain the DEGREES FAHRENHEIT (°F) setting, press the ENTER button (  ).

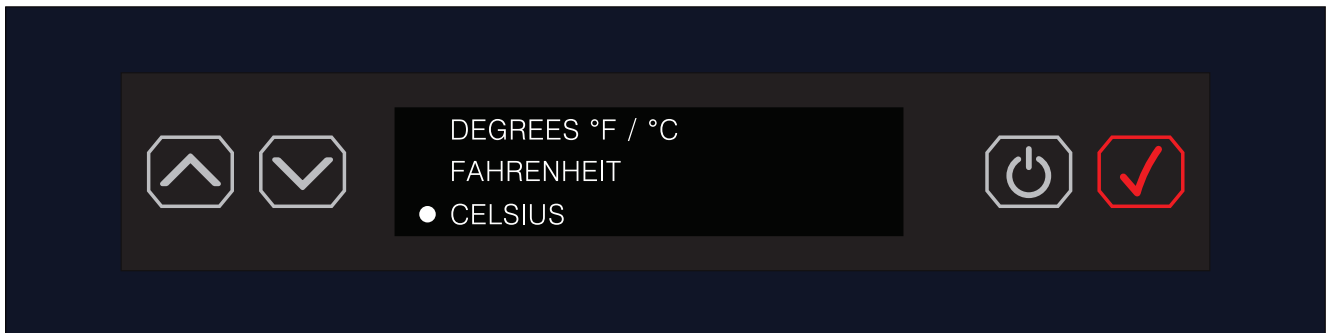

**NOTE:** DEGREES FAHRENHEIT (°F) is the default setting and displays in increments of 1 degree. DEGREES CELSIUS (°C) displays in increments of 0.5 degrees.

### ENTERING SABBATH MODE

1. Press the ENTER button (  ) to enter the menu.

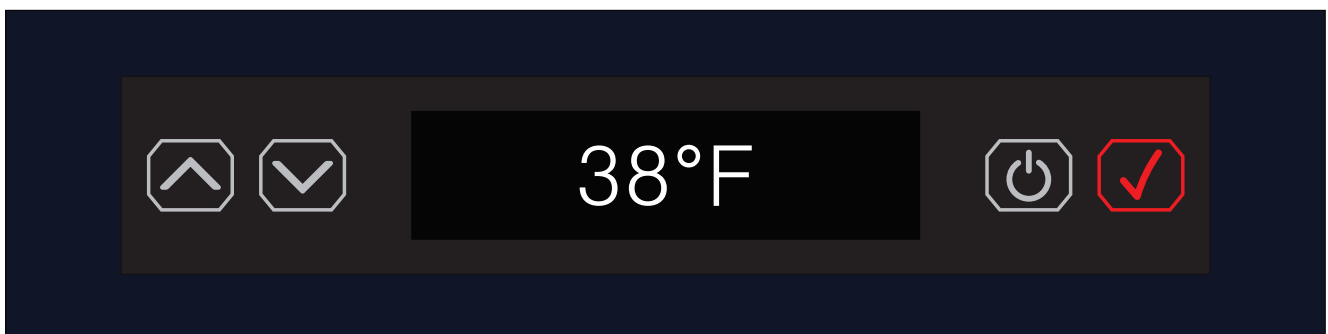

2. Scroll down to the ENTER SABBATH MODE setting.

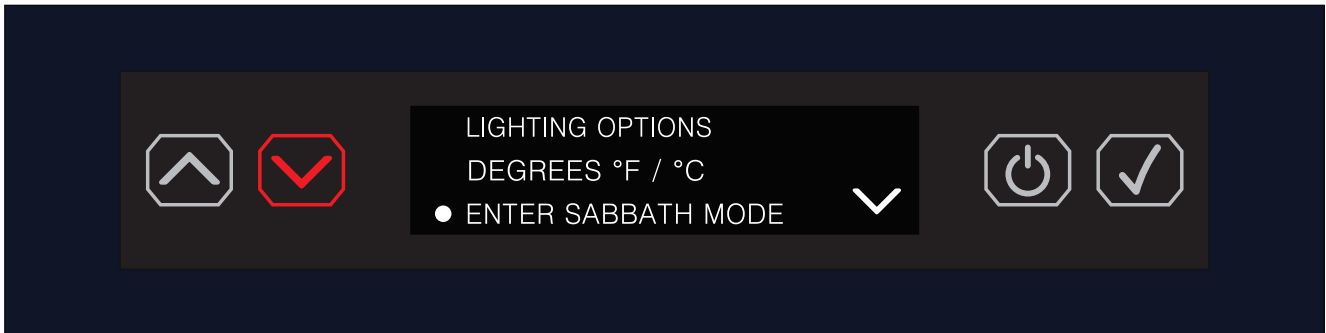

3. Press the ENTER button (✓).

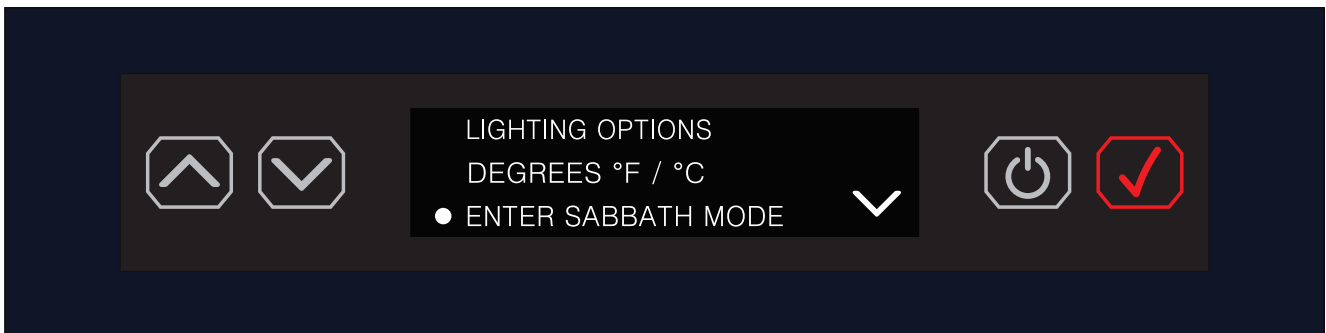

4. The display shows nothing but is still running and in SABBATH MODE. The display shows nothing, but the unit maintains the set temperature during the ENTER SABBATH MODE cycle until cancelled.

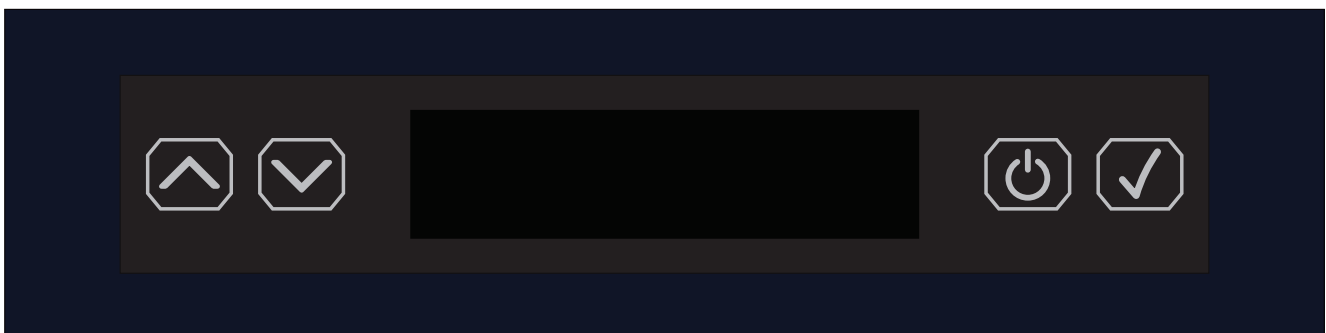

**NOTE:** Door opening or closing will result in a 20-second delay with compressor, fan or damper function.

**NOTE:** In the event of a power failure during SABBATH MODE, SABBATH MODE remains in effect.

**NOTE:** The LIGHT is always OFF within SABBATH MODE.

### EXITING OR CANCELLING SABBATH MODE

1. To exit or cancel SABBATH MODE, press the ENTER button (✓).

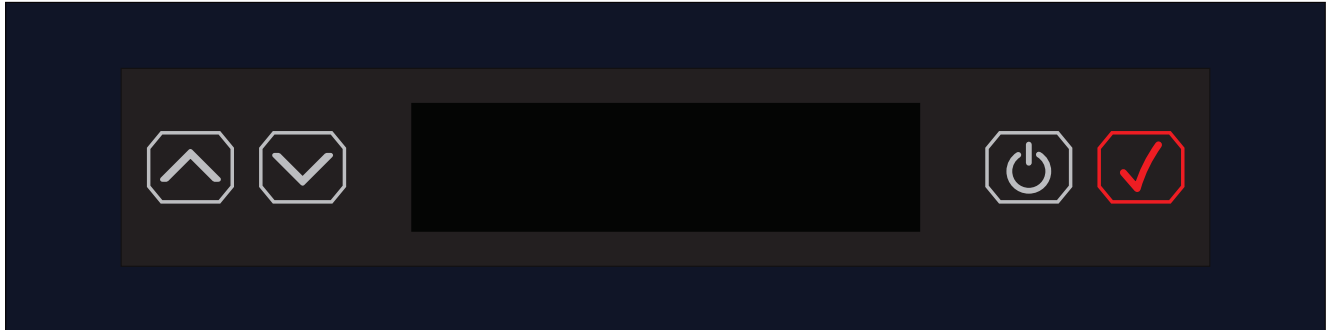

2. The display reverts back to the default screen.

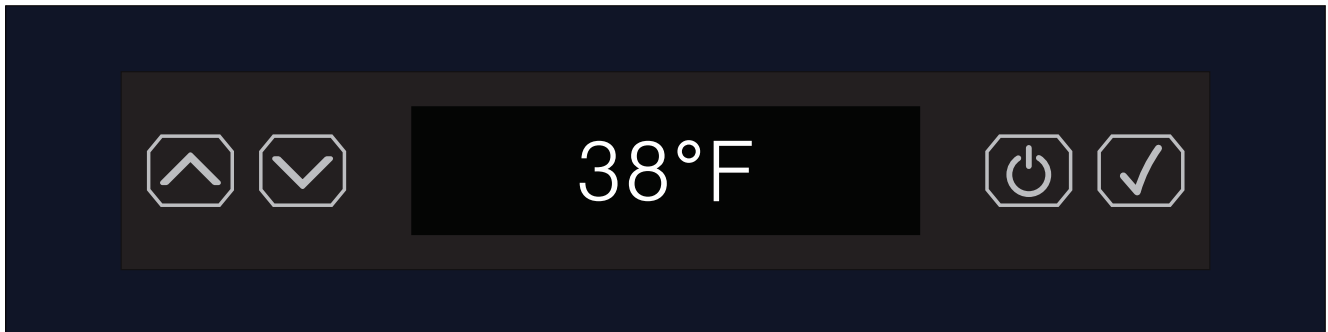

**NOTE:** The clock time in the lower right of the display appears ONLY if the clock time has been set in the NIGHTLIGHT function. Otherwise, no time will appear on the screen.

### CHANGING / ADJUSTING THE TEMPERATURE

1. To change the temperature setting, press the UP or DOWN ARROW buttons to reach the desired setting.

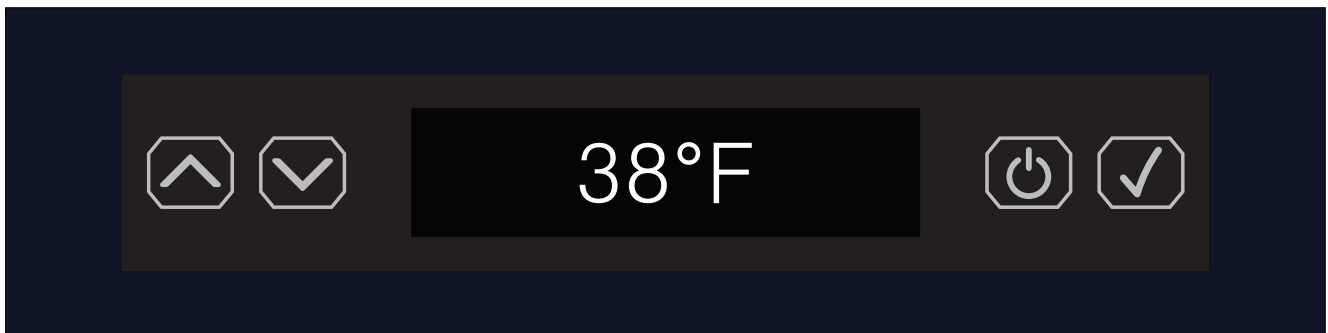

2. Press the DOWN ARROW button (  ) to change / adjust temperature lower.

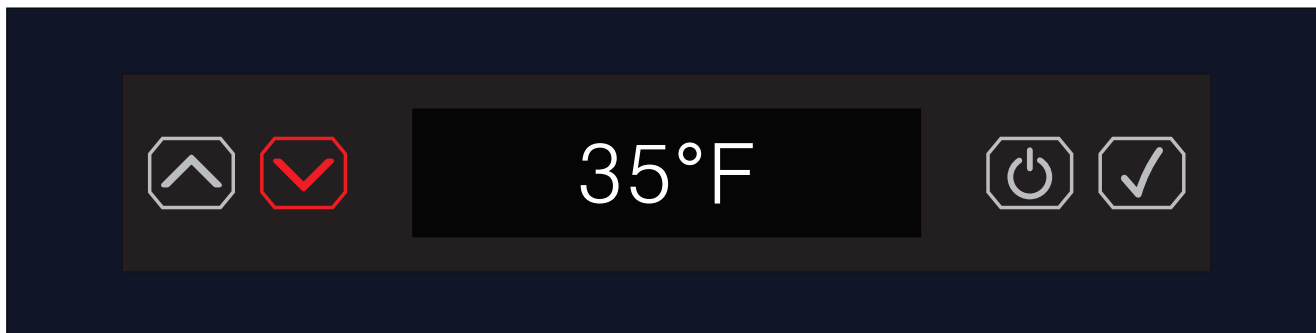

3. Press the UP ARROW button (  ) to change / adjust temperature higher.

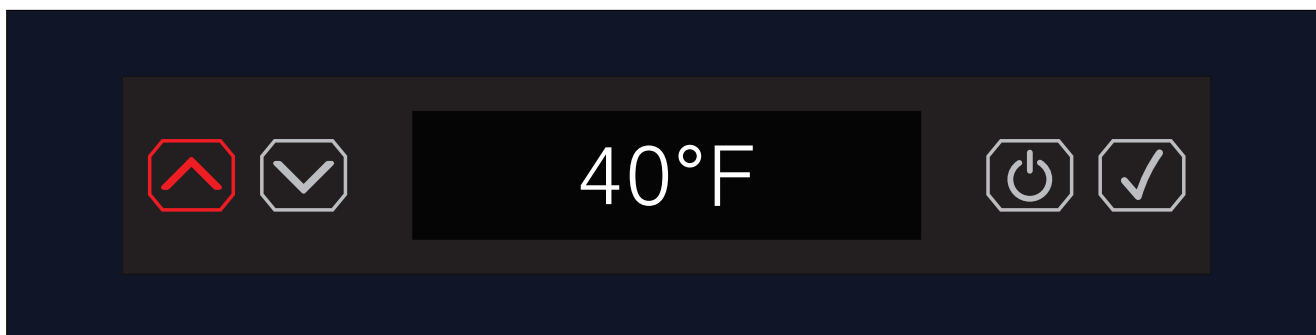

**NOTE:** You do not need to press the ENTER button. The new setting will remain unless changed.

## DEFAULT TEMPERATURE

The default temperature is **38°F**.

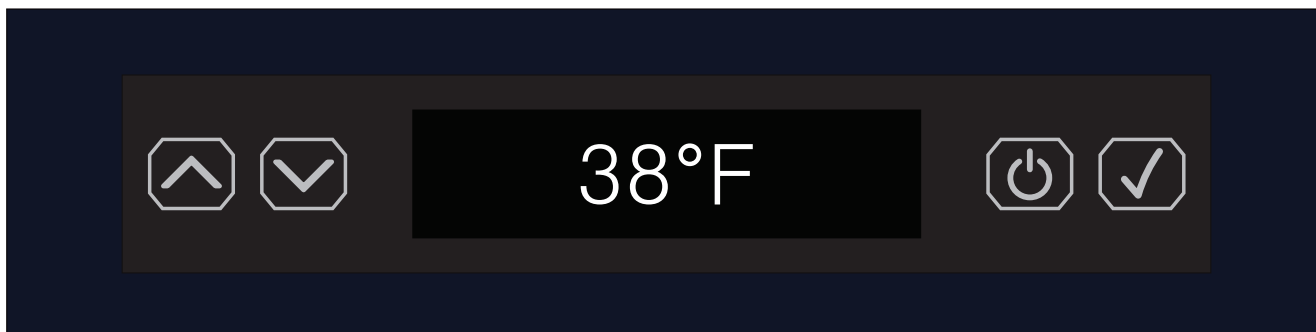

**NOTE:** Once you enter a final selection in the menu, the control / display always reverts back to the default display screen shown above.

### CLEARING SIMPLE ERROR CODES

The DOOR OPEN alert sounds and shows DOOR OPEN in the display. The alert automatically clears when you properly close the door.

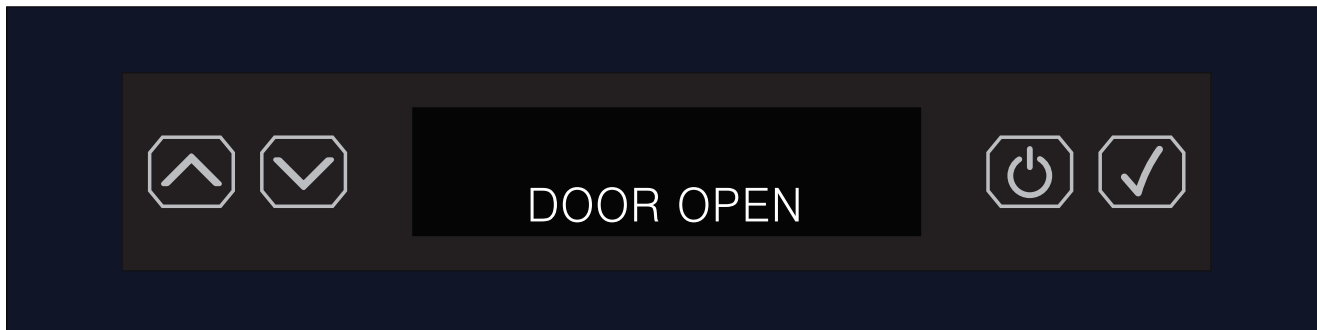

**NOTE:** The audible alert emits three beeping sounds that occur every 30 seconds after the door has remained open for more than 2 minutes. The alert automatically clears when you properly close the door. This methodology applies to any error or alert that requires an audible alert.

### OTHER / ADDITIONAL ERROR CODES

The TEMP OUT OF RANGE alert sounds and shows TEMP OUT OF RANGE in the display until the set temperature is restored.

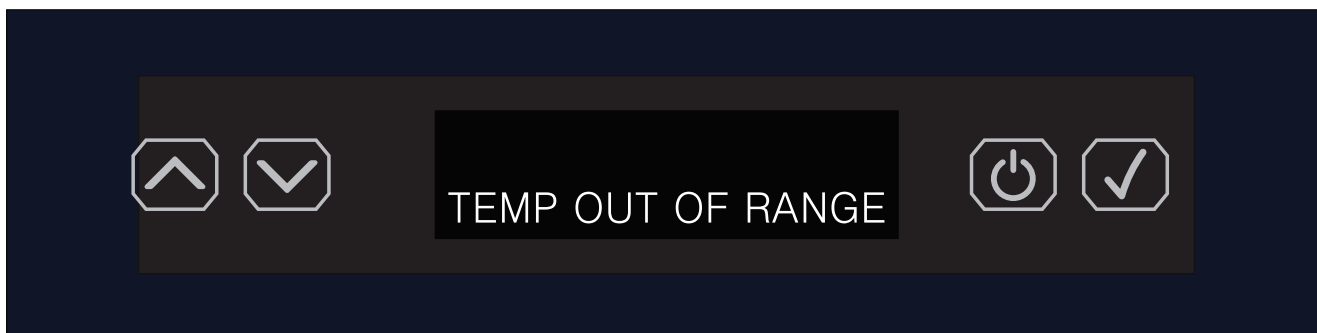

The TEMP OUT OF RANGE alert activates when the temperature level is out of range by 10 degrees Fahrenheit for a 12-hour time period.

The audible alert emits three beeping sounds that occur every 30 seconds until the set temperature is restored.

To manually clear the TEMP OUT OF RANGE alert, see the steps in “Manually Clearing Temp Out of Range Error Code” on page 37.

## MANUALLY CLEARING TEMP OUT OF RANGE ERROR CODE

1. To manually clear the TEMP OUT OF RANGE alert, press the ENTER button (✓).

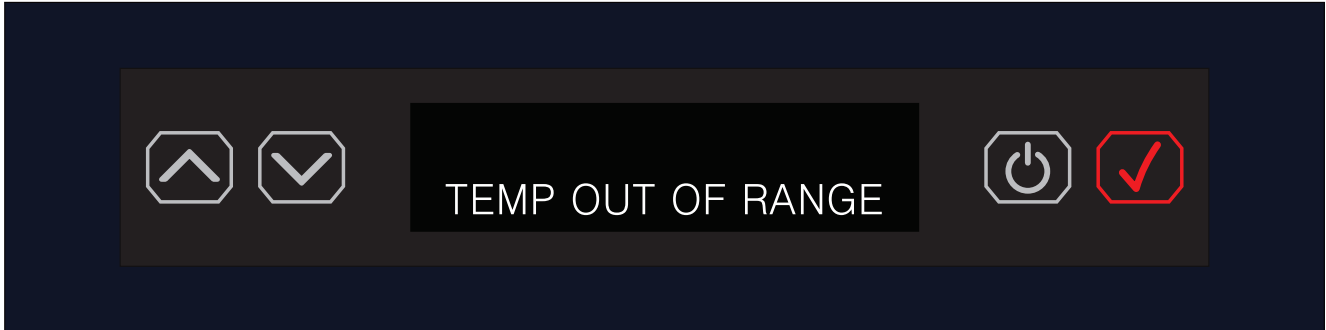

2. The display shows CLEAR TEMP ALERT?. Press the ENTER button (✓).

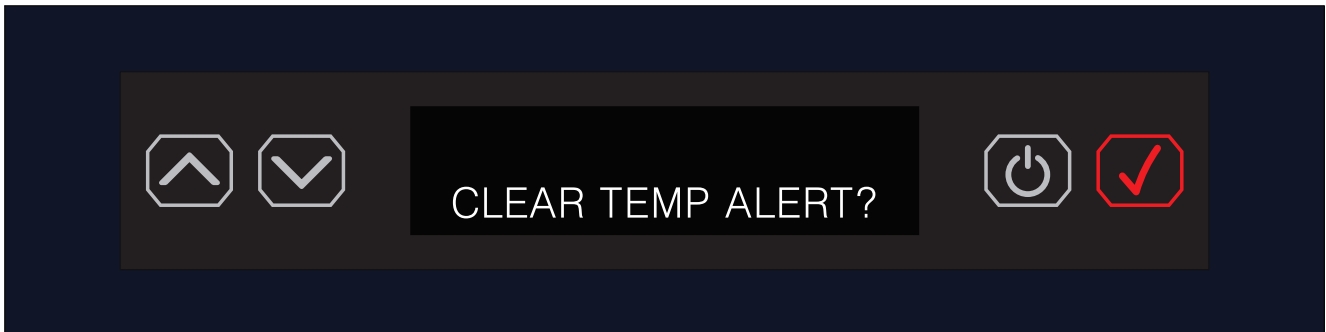

3. The display reverts back to the default display and the TEMP OUT OF RANGE alert clears.

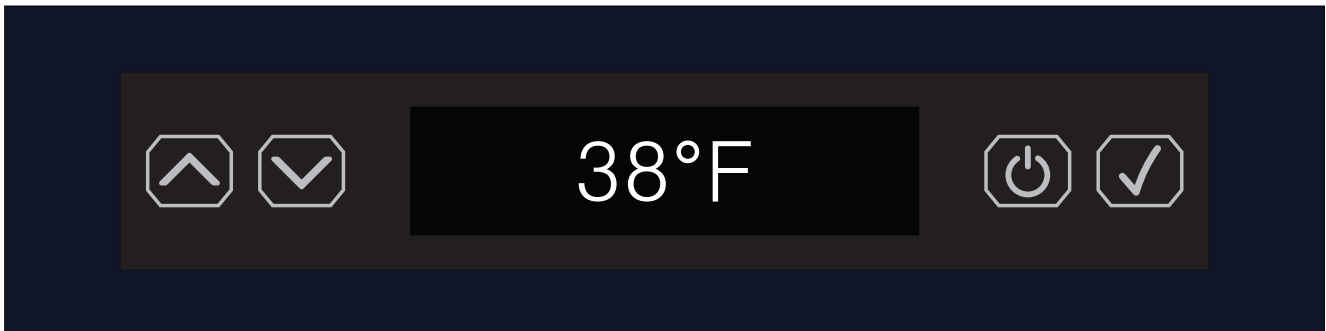

**NOTE:** If the unit does not meet the set temperature within 12 hours, the TEMP OUT OF RANGE alert will initiate again.

### EXPECTING NORMAL SOUNDS

Your new appliance may make sounds that are not familiar to you. Hard surfaces like the floor and walls can make the sounds seem louder than they actually are. The following describes the kinds of sounds that might be new to you and the source of those sounds:

- Rattling noises may come from the flow of the refrigerant. Items stored on top of the appliance can also make noises.
- The high-efficiency compressor may make a pulsating or high-pitched sound.
- You may hear the sound of the condenser fan forcing air over the condenser.

### DEALING WITH POWER FAILURE

Most power failures are corrected within a few hours and should not affect the temperature of your appliance if you minimize the number of times you open the appliance door. If the power is going to be off for a longer period of time, take the proper steps to disconnect your appliance.

#### WARNING

**Failure to unplug the appliance could result in electrical shock or personal injury.**

**NOTE:** When the appliance is operating, the evaporator is the only component that is cold.



# 5

## CARE AND MAINTENANCE

### WARNING

#### Electrical Shock Hazard

Always disconnect power at the source before working on the unit. Failure to unplug the appliance could result in electrical shock or personal injury.

- Do not touch the power plug when your hands are wet.
- Never unplug the unit by pulling on the cord. Grasp the plug and pull it out firmly.

### CLEANING AND MAINTAINING THE UNIT

Perform periodic cleaning and proper maintenance to ensure efficiency, top performance and long life. The maintenance intervals listed in this manual are based on normal conditions. You may want to shorten the intervals if you have pets or other special considerations.

Periodically vacuum dust and dirt from the condenser, which is located behind the grill at the bottom front of the unit.

#### CLEANING THE UNIT'S EXTERIOR

Clean the door and cabinet with a mild detergent and warm-water solution, such as 1 oz. (28 g) of dish-washing liquid mixed with 2 gallons of warm water. Do not use solvent-based or abrasive cleaners. Use a soft sponge and rinse the unit with clean water. Wipe the unit with a soft, clean towel to prevent water spotting.

Clean stainless steel with a mild detergent, a warm-water solution and a damp cloth. Never use an abrasive cleaning agent.

#### CLEANING THE UNIT'S INTERIOR

When necessary, thoroughly clean the inside of the unit with mild soap and water.

When cleaning, leave the unit turned off and leave the door open. Leaving the door open allows air to dry the inside of the cabinet, reducing the chance for mildew and damage to the mold mechanism's components.

### EXTENDED PERIODS OF NON-USE

#### **WARNING**

##### **Electrical Shock Hazard**

**Always disconnect power at the source before working on the unit.**

**NOTE:** Do not winterize this unit with ANY type of anti-freeze; damage to the mold coating will occur, invalidating product's Limited Warranty and creating potential health hazards.

1. Turn off the electric supply at the main power source. Remove the power cord from the electrical outlet.
2. Leave the door open to allow for circulation and to prevent mold and mildew.
3. Leave the power cord unplugged until ready to use.

#### **NOTICE**

Never pull on the power cord to unplug the appliance from the electrical outlet. Grasp the plug of the power cord and pull it out firmly.

### RECOMMISSIONING THE UNIT

1. Restore power to the unit.
2. After an initial cooldown period of 45-60 minutes, the unit will cycle approximately every 40 minutes.

### STARTING UP THE UNIT

1. Turn on the power.
2. Turn on the unit by pressing the power button.
3. The fan and compressor will normally turn on immediately, resulting in air circulation through the grill and a faint hum from the compressor.

### CLEANING THE CONDENSER

#### **WARNING**

##### **Electrical Shock Hazard**

**Always disconnect the power at the source before working on the unit.**

### CAUTION

#### Sharp Object Hazard

**DO NOT touch the condenser surface. The condenser has sharp edges and can be easily damaged.**

A dirty or clogged condenser prevents proper airflow and causes higher-than-recommended operating temperatures that may lead to component failure. Clean the condenser or have it cleaned at least once every six months.

1. Unplug the appliance or disconnect power.
2. Remove the two screws under the front of the unit. Gently pull on the grill and remove it.
3. Remove dirt and lint from the condenser and the unit compartment with the brush attachment of a vacuum cleaner.
4. Position the grill on the unit and secure it with two screws.
5. Plug in the appliance or reconnect power.

# 6

# TROUBLESHOOTING

PROBLEM	POSSIBLE CAUSES	SOLUTIONS
<ul style="list-style-type: none"> <li>The appliance does not operate.</li> </ul>	<ul style="list-style-type: none"> <li>Power failure.</li> <li>Appliance not plugged in.</li> <li>House fuse blown or circuit breaker tripped.</li> </ul>	<ul style="list-style-type: none"> <li>Plug in the appliance.</li> <li>Replace blown fuse or reset circuit breaker.</li> </ul>
<ul style="list-style-type: none"> <li>The appliance is not cold enough.</li> </ul>	<ul style="list-style-type: none"> <li>Door is opened too often.</li> <li>Door does not close completely.</li> <li>Door seal does not seal properly.</li> <li>Front bottom grill does not have sufficient ventilation.</li> <li>Appliance too close to a heat source.</li> </ul>	<ul style="list-style-type: none"> <li>Do not open door too frequently.</li> <li>See “The Door Does Not Close Properly” below.</li> <li>Be sure door seal is properly seated in groove.</li> <li>Grills must be completely unobstructed.</li> <li>Keep appliance away from heat sources.</li> </ul>
<ul style="list-style-type: none"> <li>The appliance turns on and off frequently.</li> </ul>	<ul style="list-style-type: none"> <li>Large amount of contents has been added.</li> <li>Door is open too often.</li> <li>Door does not close completely.</li> <li>Door seal not sealing properly.</li> </ul>	<ul style="list-style-type: none"> <li>Reduce amount of content added at a time.</li> <li>Do not open door too frequently.</li> <li>See “The Door Does Not Close Properly” below.</li> <li>Be sure door seal is properly seated in groove.</li> </ul>
<ul style="list-style-type: none"> <li>The door does not close properly.</li> </ul>	<ul style="list-style-type: none"> <li>Appliance not level.</li> <li>Door was reversed and not properly installed.</li> <li>The shelves are out of position.</li> </ul>	<ul style="list-style-type: none"> <li>Be sure appliance is installed on hard level surface.</li> <li>Verify door is properly installed.</li> <li>Verify shelves are properly installed.</li> </ul>
<ul style="list-style-type: none"> <li>Noise during operation.</li> </ul>	<ul style="list-style-type: none"> <li>Feet are not leveled.</li> <li>Certain sounds are normal.</li> </ul>	<ul style="list-style-type: none"> <li>Level the feet. See “Leveling the Unit” on page 12.</li> <li>See “Expecting Normal Sounds” on page 38.</li> </ul>
<ul style="list-style-type: none"> <li>The compressor works abnormally with a buzzing noise.</li> </ul>	<ul style="list-style-type: none"> <li>The voltage is lower than recommended.</li> </ul>	<ul style="list-style-type: none"> <li>Stop the appliance and do not restart until the voltage is normal.</li> </ul>

# 7

## DISPOSING THE UNIT



This symbol on the product or its packaging indicates that you cannot treat this product as normal domestic trash; you must hand it in to a collection point for recycling electric and electronic appliances. Your contribution to the correct disposal of this product protects the environment.

Contact your local municipal authority if you need more information about recycling this product.

### **DANGER**

**Always remove the door and keep the shelves in place when discarding this appliance so children may not become entrapped.**

# WARRANTY

## LIMITED WARRANTY COVERAGE

The Legacy Companies, warrants to the original purchaser of its SAPPHIRE products that they will be free from defects in materials and workmanship for the following time periods from the date of purchase shown on the sales receipt:

Two (2) year Parts & On-site Labor

Five (5) years Compressor Warranty (Parts only)

## WARRANTY EXCLUSIONS

**NO CONSEQUENTIAL DAMAGES:** SAPPHIRE and The Legacy Companies are not responsible for any economic loss or special, indirect or consequential damages including without limitation; loss of revenue and loss or damage arising from food or product spoilage claims.

**WARRANTY IS NOT TRANSFERABLE:** This warranty is not transferable or assignable and applies only to the original verified purchaser.

**NO IMPLIED WARRANTY OF MERCHANTABILITY OR FITNESS FOR PARTICULAR SERVICE:** There are no other warranties statutory, express, or implied. This Limited Warranty is the exclusive warranty and made in lieu of all other warranties including any implied warranties or any warranties of merchantability or fitness for a particular purpose.

**FILING WARRANTY CLAIMS:** All warranty claims for SAPPHIRE products must be made directly through The Legacy Company's Technical Service Department. All claims should include: model and serial number, proof of purchase, date of installation, location purchased, and all pertinent information supporting the existence of the claim.

**IMPROPER ELECTRICAL AND WATER CONNECTIONS:** SAPPHIRE and The Legacy Companies are not responsible for the repair or replacement of any failed or damaged components resulting from electrical power failure, the use of extension cords, low voltage or voltage spikes to the unit. Likewise, repair or replacement attributable to low water pressure, high water pressure or contaminated water are not covered by this Limited Warranty.

**IMPROPER USAGE:** Neither SAPPHIRE nor The Legacy Companies assumes liability for parts or labor coverage for component failure or other damages resulting from improper usage or installation or failure to clean and/or maintain the product as set forth in the Owner's Manual provided with each unit.

**CONSUMABLES:** This warranty does not include consumable parts such as water filters and light bulbs.

**ADJUSTMENTS & CALIBRATIONS:** Adjustments including calibrations, leveling, tightening of fasteners, or utility connections normally associated with the original installation are the responsibility of the dealer, installer or the end user and not the responsibility of SAPPHIRE or The Legacy Companies and will not be considered warranty issues for this Limited Warranty.

**CONSEQUENTIAL DAMAGES:** This warranty does not cover any defect due to, or resulting from, ordinary wear and tear, handling, abuse, misuse, or harsh chemical action, nor shall it extend to any product from which the serial number has been removed or altered, or modifications made by unauthorized service personnel or damage by flood, fire, earthquake or other Acts of God.

**OUTSIDE U.S. & CANADA:** This warranty does not apply to, and SAPPHIRE and The Legacy Companies are not responsible for any warranty claims made on products sold or used outside of the United States and Canada or any territories of the United States of America.

**ALL REPAIRS AND SERVICE MUST BE MADE BY A SAPPHIRE AUTHORIZED TECHNICIAN.**

Customer Service: 1.866.754.6672  
SAPPHIRE Appliances | The Legacy Companies  
3355 Enterprise Avenue, Suite 160, Weston, FL 33331  
email@sapphireappliances.com | SapphireAppliances.com

# SAPPHIRE

SapphireAppliances.com | 866.754.6672  
SAPPHIRE Appliances | The Legacy Companies  
3355 Enterprise Avenue, Suite 160, Fort Lauderdale, FL 33331