

SFU4104MCS



Category	Compact 24"
Product family	Oven
Power supply	Electrical
Power supply	Electricity
Cooking method	Combi Microwave
Cleaning system	VaporClean
EAN code	8017709265823



Aesthetic

Aesthetics	Linea	Silkscreen type	Symbols
Color	Silver	Door	Full-glass
Design	Flat	Handle	Linea-design
Material	Glass	Handle color	Chromed
Glass type	Stopsol	Logo	Silkscreened
Silkscreen color	White		

Controls

			
Display technology	TFT	No. of display languages	11
Controls setting	Full-touch	Display languages	Italiano, English (US), Français (CA), Español (MX), Português (PT), zh-CHS, zh-CHT

Programs / Functions

No. of cooking functions	13
Automatic programmes	50
Customisable recipes	10

Traditional cooking functions

- Static
- Fan-assisted
- True European convection
- Turbo
- Eco
- Large grill
- Fan grill (large)
- Circulaire + grill
- Bottom
- Convection bottom

Microwave functions

- Microwave
- Fan-assisted
- True European convection
- Microwave + Grill
- Warming and re-generation

Other functions

- Defrost by time
- Defrost by weight
- Proof
- Sabbath

Cleaning functions

- Vapor Clean

Options



Time-setting options	Delayed start and automatic shut-off when cooking ends	Other options	Keep-warm, Eco light, Quick start
Minute minder	Yes	Showroom mode	Yes
Child safety lock	Yes		

Technical Features



Minimum Temperature	86 °F	Door opening	Standard opening
Maximum temperature	482 °F	Door	Cool-touch door
No. of shelves	3	Total no. of door glasses	3
No. of lights	2	Microwave stops when door is opened	Yes
Lighting	Halogen	Soft Close	Yes
Light power	40 W	Cooling system	Tangential
Light on when door is open	Yes	Cooling duct	Single
Lower heating element power	1000 W	Temperature control	Electronic
Grill element - power	2000 W	Cavity material	EverClean enamel

Circular heating element 1400 W
- Power
Heating elements stop Yes
when door is opened

Microwave screen protection Yes

Performance / Energy Label



Volume of the cavity 1.41 cu. ft.

Microwave effective power 1000 W

Accessories Included



Rack with back and side stop 1
Insert grid 1

Glass tray 1
Telescopic Guide rails, partial Extraction 1

Electrical Connection

Voltage 230 V
Nominal power 3400 W
Voltage 120/208 V

Current 13 A
Frequency 60 Hz
Power cord length 45 1/4 "

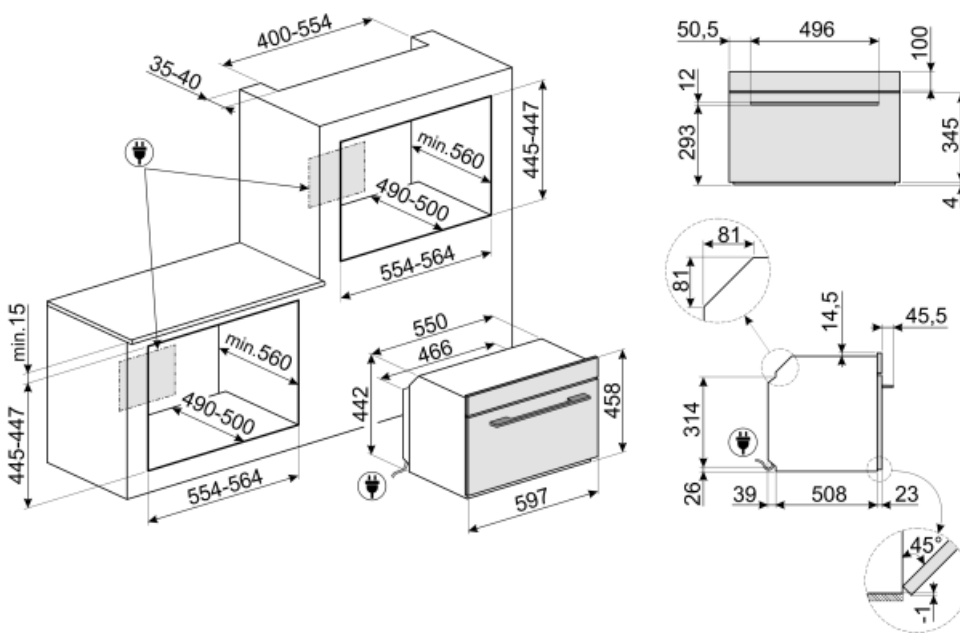

Not included accessories

GTP

****Partial-extension telescopic guides****
Length: 14" Extraction: 11 1/4" Material:
Stainless steel AISI 430 polished



BN620-1

Enamelled tray, 20mm deep



GTT

****Total-extension telescopic guides****
Length: 14" Extraction: 16.5" Material:
Stainless steel AISI 430 polished



PR3845X

Antifingerprint stainless steel. Cover
for furniture in column installation of
more ovens



PALPZ

Pizza shovel with fold away handle
width: 315mm length : 325mm





































BN640

Enamelled tray, 40mm deep



Symbols glossary (TT)

 <p>Child lock: some models are fitted with a device to lock the programme/cycle so it cannot be accidentally changed.</p>	 <p>Combination microwave: This oven allows to combine two different ways of cooking (Traditional with microwaves). Combined ovens increase cooking opportunities, while providing maximum flexibility of household appliances.</p>
 <p>Air cooling system: to ensure a safe surface temperatures.</p>	 <p>Defrost by time: with this function the time of thawing of foods are determined automatically.</p>
 <p>Defrost by weight: With this function the defrosting time is determined</p>	 <p>Triple glazed doors: Number of glazed doors.</p>
 <p>Automatic lighting switches off: for greater energy savings, the lighting switches off automatically after one minute from the start of cooking.</p>	 <p>Electric</p>
 <p>Enamel interior: The enamel interior of all Smeg ovens have a special antacid lining which helps keep the interior clean by reducing the amount of cooking grease adhering to it.</p>	 <p>Circogas: In gas ovens the fan distributes the heat quickly and evenly throughout the oven cavity, avoiding flavour transfer when cooking a number of different dishes at the same time. In electric ovens this combination completes cooking more quickly of foods that are ready on the surface, but that require more cooking inside, without further browning.</p>
 <p>Fan with upper and lower elements: The elements combined with the fan aim to provide more uniform heat, a similar method to conventional cooking, so pre-heat is required. Most suitable for items requiring slow cooking methods.</p>	 <p>Upper and lower element only: a traditional cooking method best suited for single items located in the centre of the oven. the top pf the oven will always be hottest. Ideal for roast, fruit cakes, bread etc.</p>
 <p>Lower heating element only: This function is ideal for foods that require extra base temperature without browning, e.g. pastry dishes, pizza. Also suitable for slow cooking of stews and casseroles.</p>	 <p>Circulaire + grill: Circulaire with upper element or grill: Similar to fan with upper element with the added cooking speed of circulaire, ideal for dishes with a crispy topping. When used with the grill the food will brown more quickly.</p>
 <p>True European Convection: The combination of the fan and circular heating element around it provides many benefits, including no preheat if cooking time is longer than 20 minutes, no flavor transfer when cooking different foods at the same time, lower energy consumption, and shorter cooking times. Suitable for all types of food preparations.</p>	 <p>ECO: The combination of the grill, fan and lower element is particularly suitable for cooking small quantities of food.</p>

- | | |
|--|---|
|  <p>Grill element: Using of grill gives excellent results when cooking meat of medium and small portions, especially when combined with a rotisserie (where possible). Also ideal for cooking sausages and bacon.</p> |  <p>Fan with grill element: The fan reduces the fierce heat from the grill, providing an excellent method of grilling various foods, chops, steaks, sausages etc. giving even browning and heat distribution, without drying out the food. The top two levels recommended for use, and the lower part of the oven can be used to keep items warm at the same time, an excellent facility when cooking a grilled breakfast. Half grill (centre portion only) is ideal for small quantities of food.</p> |
|  <p>Microwave: Penetrating straight into the food, microwaves cook very quickly and with considerable energy savings. Suitable for cooking without fat, they are also able to thaw and heat food without altering its original appearance and aroma. The microwave function can also be combined with conventional functions with all the resulting advantages. Ideal for all types of food.</p> |  <p>Cooking with the simultaneous use of the heating element in combination with fan and microwave supply.</p> |
|  <p>Microwave + grill element: The use of the grill results in a perfect browning of the surface of the food. The action of microwaves allows instead of cooking in a short time the internal part of the food.</p> |  <p>Fan combined with traditional cooking, where heat is generated from above and below, provides uniform heat. Adding the microwave function allows the same cooking results in less time.</p> |
|  <p>This function can reheat precooked dishes, without becoming dry or hard.</p> |  <p>Circulaire with upper and lower elements: The use of the fan with both elements allows food to be cooked quickly and effectively, ideal for large joints that require thorough cooking. It offers a similar result to rotisserie, moving the heat around the food, instead of moving the food itself, enabling any size or shape to be cooked.</p> |
|  <p>Compact appliances with a height of 45 cm - perfect solution to meet the functional requirements of kitchen sets of small height. Available in several types and in different styles.</p> |  <p>KEEP_WARM_72dpi</p> |
|  <p>Side lights: Two opposing side lights increase visibility inside the oven.</p> |  <p>ECO-logic: option allows you to restrict the power limit of the appliance real energy saving.</p> |
|  <p>Air at 40°C provides the perfect environment for proving yeast type dough mixes. Simply select the function and place dough in the cavity for allotted</p> |  <p>Sabbath: This function allows you to cook food during the Sabbath, the Holiday of rest in the Jewish religion, respecting the precepts. The oven works</p> |
|  <p>The oven cavity has 3 different cooking levels.</p> |  <p>Soft close: all models are equipped with advanced function of smooth closing of the door, which allows the device to close smoothly and quietly.</p> |
|  <p>Telescopic rails: allow you to pull out the dish and check it without having to remove it from the oven entirely.</p> |  <p>Electronic control: Allows you to maintain temperature inside the oven with the precision 2-3 ° C. This enables to cook meals that are very sensitive to temperature changes, such as cakes, souffles, puddings.</p> |



Tilting grill: the tilting grill can be easily unhooked to move the heating element and clean the roof of the appliance in one simple step.



Touch controls: Easy to use touch controls allow the appliance to be programmed at the touch of a button.



Vapor Clean: a simple cleaning function using steam to loosen deposits in the oven cavity.



The capacity indicates the amount of usable space in the oven cavity in litres.