

SPR24UIMX

Range size	24"
Oven energy source	Electricity
Cooktop type	Induction
Main oven	Thermo-ventilated
Cleaning system - Main oven	VaporClean
EAN code	8017709332341



Aesthetic



Series	Professional	No. of controls	2
Color	Stainless steel	Display	Touch
Finishing	Satin	Handle	Robust knurled handle
Control panel finish	Stainless steel	Handle color	Brushed stainless steel
Cooktop color	Stainless steel	Storage compartment	Storage drawer
Control knobs	Pro-style control knobs	Feet	Stainless steel

Programs / Functions

No. of cooking functions 8

Traditional cooking functions

Static	Fan-assisted	True European convection
Small grill	Large grill	Large grill + Fan
Convection bottom	Pizza	

Cleaning functions

VaporClean

Other functions

Defrost by time

Cooktop options



End cooking timer	4	Limited power consumption option	Yes
Minute minder	1	Multizone Option	Yes

Cooktop technical features



Cooking zones 4			
Front-left - 1300 W - Booster 1400 W - Ø 18.0 cm			
Rear-left - 2300 W - Booster 3000 W - Ø 18.0 cm			
Front-right - 2300 W - Booster 3000 W - Ø 14.5 cm			
Rear-right - 1300 W - Booster 1400 W - Ø 21.0 cm			
Booster power left	3700 W	Minimum pan diameter indicator	Yes
Multizone		Selected zone indicator	Yes
Automatic switch-off in case of over-heating	Yes	Residual heat indicator	Yes
Automatic switch-off in case of overflow	Yes		
Automatic pan detection	Yes		

Main Oven Technical Features



No. of lights	1	Total no. of door glasses	3
Fan number	1	Cooling system	Tangential
Volume	2.79 cu. ft.	Bottom heating element - Power	1200 W
Cavity material	EverClean enamel	Upper heating element - Power	1000 W
No. of shelves	5	Grill power	1700 W
Light type	Halogen	Large grill - Power	2700 W
Light Power	40 W	Circular heating element - Power	2000 W
Time setting	Minute minder	Grill type	Electric
Removable door	Yes	Soft Close system	Yes
Removable inner door	Yes		

Main oven options

Minimum Temperature	151 °F	Maximum temperature	500 °F
---------------------	--------	---------------------	--------

Accessories included for main oven and cooktop

Oven wire rack 2

Electrical Connection

Plug	(B) NEMA 14-50P	Type of electric cable installed	Yes, Double phase
Circuit breaker	40 A	Power cord length	47 1/4 "
Voltage	208/240 V	Frequency	60 Hz

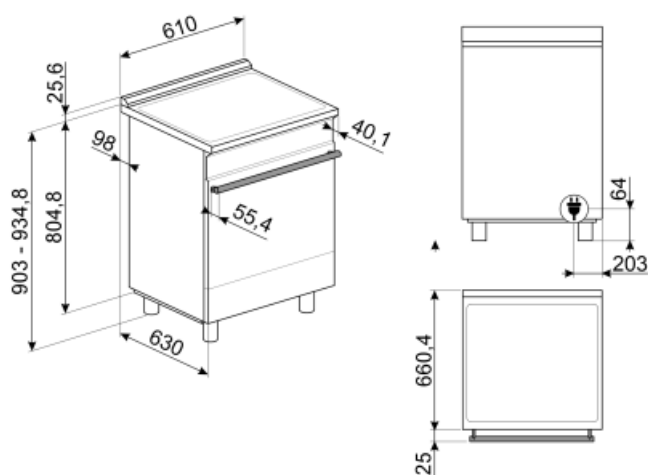

Not included accessories



SFLK1
Child lock



PRTX
Refractory pizza stone with handles.
D=35cm Not suitable for microwave
ovens. Suitable for gas ovens, to be put
on the griddle.



GRM
Gas hobs moka support



KITTKSPR24
Plinth, 3 sides, 900mm , SPR cookers
24", black



GTP
**Partial-extension telescopic
guides** Length: 14" Extraction: 11
1/4" Material: Stainless steel AISI 430
polished



WOKGHU
Cast-Iron WOK Support





























SCRP
Induction and ceramic hobs and
teppanyaki scraper



PALPZ
Pizza shovel with fold away handle
width: 315mm length : 325mm

Symbols glossary (TT)

 <p>Automatic merge of zones for a bigger area</p>	 <p>Installation in column: Installation in column</p>
 <p>Air cooling system: to ensure a safe surface temperatures.</p>	 <p>Defrost by time: with this function the time of thawing of foods are determined automatically.</p>
 <p>...</p>	 <p>Triple glazed doors: Number of glazed doors.</p>
 <p>ECO-logic: option allows you to restrict the power limit of the appliance real energy saving.</p>	 <p>Enamel interior: The enamel interior of all Smeg ovens have a special antacid lining which helps keep the interior clean by reducing the amount of cooking grease adhering to it.</p>
 <p>Circogas: In gas ovens the fan distributes the heat quickly and evenly throughout the oven cavity, avoiding flavour transfer when cooking a number of different dishes at the same time. In electric ovens this combination completes cooking more quickly of foods that are ready on the surface, but that require more cooking inside, without further browning.</p>	 <p>Fan with upper and lower elements: The elements combined with the fan aim to provide more uniform heat, a similar method to conventional cooking, so pre-heat is required. Most suitable for items requiring slow cooking methods.</p>
 <p>Upper and lower element only: a traditional cooking method best suited for single items located in the centre of the oven. the top pf the oven will always be hottest. Ideal for roast, fruit cakes, bread etc.</p>	 <p>True European Convection: The combination of the fan and circular heating element around it provides many benefits, including no preheat if cooking time is longer than 20 minutes, no flavor transfer when cooking different foods at the same time, lower energy consumption, and shorter cooking times. Suitable for all types of food preparations.</p>
 <p>Grill element: Using of grill gives excellent results when cooking meat of medium and small portions, especially when combined with a rotisserie (where possible). Also ideal for cooking sausages and bacon.</p>	 <p>Half grill: For rapid cooking and browning of foods. Best results can be obtained by using the top shelf for small items, the lower shelves for larger ones, such as chops or sausages. For half grill heat is generated only at the centre of the element, so is ideal for smaller quantities.</p>
 <p>Fan with grill element: The fan reduces the fierce heat from the grill, providing an excellent method of grilling various foods, chops, steaks, sausages etc. giving even browning and heat distribution, without drying out the food. The top two levels recommended for use, and the lower part of the oven can be used to keep items warm at the same time, an excellent facility when cooking a grilled breakfast. Half grill (centre portion only) is ideal for small quantities of food.</p>	 <p>Pizza function: The simultaneous operation of three elements ensures an optimum cooking facility when used with the Smeg pizza stone.</p>
 <p>Overheat protection: The safety system that automatically turns off the hob in case of overheating of the control unit.</p>	 <p>Induction: The work of these hobs is based on the principle of electromagnetic induction. The heat is generated directly in the bottom of the pan during its contact with the hob.</p>

-
- | | |
|--|---|
|  The inner door glass: can be removed with a few quick movements for cleaning. |  Side lights: Two opposing side lights increase visibility inside the oven. |
|  Overfill protection: The special overfill protection shuts down the stove in the presence of overflow of liquids. |  Indication of residual heat: After the glass ceramic hob is switched off the residual heat indicator shows which of the heating zones still remains hot. When the temperature drops below 60 ° C, the indicator goes out. |
|  The oven cavity has 5 different cooking levels. |  Soft close: all models are equipped with advanced function of smooth closing of the door, which allows the device to close smoothly and quietly. |
|  Timer: All ceramic hobs have a timer which automatically ends cooking after a preset time. |  Vapor Clean: a simple cleaning function using steam to loosen deposits in the oven cavity. |

Benefit (TT)

True-convection

The best cooking performances guaranteed by ventilated circular flow.

Multiple fans and heating elements guarantee the perfect aerodynamic heat flow, allowing homogeneous and quicker cooking inside the cavity.

Induction hob

Induction offers fast cooking and precise temperature control

Through the use of suitable cookware, induction is easy to use and maintain, safe and responsive

Vapor Clean

By inserting water into a recess at the bottom of the cavity, steam is generated, which softens the residue and facilitates its removal

By inserting water into a recess at the bottom of the cavity, steam is generated, which softens the residue and facilitates its removal.

Touch control

Easy and intuitive timer setting with a single touch

Single turbine

The oven has a fan equipped with a circular heating element allowing cooking with rotating heat

Isothermic Cavity

The best cooking performance at the highest energy efficiency

Tangential cooling

New cooling system with tangential fan and airflow from the door to the splashback

Soft close

The door is equipped with a specific system for silent closing

Multilevel halogen light

Internal halogen lighting on different levels guarantees excellent visibility

Adjustable height

Cooker top flushed with the working area thanks to adjustable feet

Removable inner glass

Internal door glasses are easily removable for complete cleaning

Multilevel cooking

Several cooking levels allow maximum flexibility of use

Cold door

During any function, the external door glass is cold, avoiding any risk of burns

AirFry (AIRFRY optional accessory)

Lighter and tastier food thanks to airfry basket

BBQ (optional accessory)

Barbeque cooking directly in the oven with the double-sided grill

Pizza stone (optional accessory)

Baking with refractory stone for soft and crispy pizza and yeast products (STONE optional accessory)

Storage compartment

More space thanks to the lower compartment, ideal for storing accessories or cooking utensils