

# Table of Contents

<b>1 Description</b>	<b>15</b>
1.1 General Description	15
1.2 Cooktop	16
1.3 Control panel	16
1.4 Other parts	17
1.5 Available accessories	18
<b>2 Use</b>	<b>19</b>
2.1 Instructions	19
2.2 Using the accessories	21
2.3 Using the cooktop	22
2.4 Using the oven	25
2.5 Programming clock	25
2.6 Cooking advice	29
<b>3 Cleaning and maintenance</b>	<b>32</b>
3.1 Instructions	32
3.2 Cleaning the cooktop	33
3.3 Cleaning the door	33
3.4 Cleaning the oven cavity	35
3.5 Special maintenance	36



## WARNING

**Never Operate the Top Surface Cooking Section of this Appliance Unattended.**

- Failure to follow this warning statement could result in fire, explosion, or burn hazard that could cause property damage, personal injury, or death.
- If a fire should occur, keep away from the appliance and immediately call your fire department.

**DO NOT ATTEMPT TO EXTINGUISH AN OIL/GREASE FIRE WITH WATER.**

We advise you to read this manual carefully, which contains all the instructions for maintaining the appliance's aesthetic and functional qualities.

For further information on the product: [www.smeg.com](http://www.smeg.com)



## Important Safety Instructions

### Important Note to the Customer



#### WARNING

If the instructions contained in this manual are not followed precisely, a fire or explosion may result causing property damage, personal injury or loss of life.

#### FOR YOUR SAFETY

- Do not store or use gasoline or other flammable vapors, liquids or materials near this or any other appliance.

#### WHAT TO DO IF YOU SMELL GAS

- Do not try to light any appliance.
- Do not touch any electrical switch.
- Do not use any telephones in your building.
- Immediately call your gas supplier from a neighbor's phone. Follow the gas supplier's instructions.
- If you cannot reach your gas supplier, call the fire department.
- - Installation and service must be performed by a qualified installer, service company or gas supplier.



#### WARNING: Tip Over Hazard

- A child or adult could tip the range over and be killed.
- Verify the anti-tip device has been properly installed and engaged.
- Ensure the anti-tip device is re-engaged when the range is moved.
- Do not operate the range without the anti-tip device in place and engaged.
- Failure to follow these instructions can result in death or serious burns to children and adults.



- Check for proper installation and use of the anti-tip bracket. Carefully tip the range forward by pulling it from the back to ensure that the anti-tip bracket engages the range leg and prevents tip-over. The range should not move more than 1" (2.5cm).
- Read all instructions before using this appliance.



- This manual contains important safety symbols and instructions. Please pay attention to these symbols and follow all instructions given.
- Do not attempt to install or operate your appliance until you have read the safety precautions in this manual. Safety instructions throughout this manual are labeled with a WARNING or CAUTION statement based on the risk type.
- Warnings and important instructions appearing in this guide are not meant to cover all possible conditions and situations that may occur. Common sense, caution, and care must be exercised with installing, maintaining or operating your appliance.
- Keep these instructions with your owner's guide for future reference.

## Definitions

- This manual contains important safety symbols and instructions. Please pay attention to these symbols and follow all instructions given.



### WARNING

This symbol will help alert you to situations that may cause serious bodily harm, death or property damage.



### CAUTION

This symbol will help alert you to situations that may cause injury or property damage.

## Unpacking and installation

- Remove all tape and packaging before using the appliance. Dispose of the packaging after unpacking the appliance. Never allow children to play with packaging material.
- Remove all temporary labels from the oven and cooktop.



## Important Safety Instructions

- Record the Model and Serial number on Page 2 of this booklet. The Model and Serial numbers are on the Cooker ID plate. The plate is visibly located on the right side of the oven door frame. **THE ID PLATE MUST NOT BE REMOVED.**
- Do not leave the packing materials around the home. Sort the various items of waste and take them to the nearest specialized waste collection facility.
- Cold temperatures can damage the electronic control. If this appliance has not been used for a long time, make sure that it has been stored at temperatures above 32°F (0°C) for at least 3 hours before turning power on.
- Never modify or alter the construction of the appliance. For example, do not remove leveling legs, panels, wire covers or anti-tip brackets/screws.
- Be sure to have an appropriate foam-type fire extinguisher available, clearly visible and easily accessible located near the appliance.
- All materials used to make cabinets, enclosures, and supports surrounding the product must have a temperature rating of above 200°F (94°C).

### Grounding instructions

- Fire hazard or electrical shock.
- Failure to follow these instructions may result in electrical shock or other personal injury.
- Do not use an adapter.
- Do not use an extension cord.
- For appliances equipped with a cord and plug, do not cut or remove the ground prong. It must be plugged into a matching grounding type receptacle to avoid electrical shock, fire, serious injury, or death. If there is any doubt as to whether the wall receptacle is properly grounded, the customer should have it checked by a qualified electrician.



- Installation must conform with local codes or, in the absence of local codes, with the National Fuel Gas Code, ANSI Z223.1/ NFPA 54 or, in Canada, the Natural Gas and Propane Installation Code, CSA B149.1.
- The appliance must be electrically grounded in accordance with local codes or, in the absence of local codes, with the National Electrical Code, NFPA 70 latest edition or, in Canada, the Canadian Electric Code, CSA C22.1-02.
- Install only as per the installation instructions provided in the documentation received with this appliance.
- It is the personal responsibility of the consumer to have the appropriate outlet or junction box with the correct, properly grounded wall receptacle installed by a qualified electrician.
- It is the responsibility and obligation of the consumer to contact a qualified installer to assure that the electrical installation is adequate and is in conformance with all local codes and ordinances.
- See the installation instructions provided with this appliance for complete installation and grounding instructions.

## Instructions for using the appliance

- Flammable materials should not be stored in the oven, near surface burners or elements, or in the storage or warmer drawer (if provided). This includes paper, plastic, and cloth items, such as cookbooks, plasticware and towels, as well as flammable liquids.
- Do not store explosives, such as aerosol cans, on or near the appliance.



## Important Safety Instructions

- **DO NOT LEAVE CHILDREN UNATTENDED:** Children should not be left alone or unattended in the area where the appliance is being used. Never allow children to sit or stand on any part of the appliance.



### WARNING

Never leave children alone or unattended in the area where an appliance is in use. As children grow, teach them the proper, safe use of all appliances. Never leave the oven door open when the cooker is unattended.



### CAUTION

Do not store items of interest to children in cabinets above a cooker or on the backguard of a cooker - children climbing on the cooker to reach items could be seriously injured

- Do not allow children to climb or play around the appliance. The weight of a child on an open oven door may cause the appliance to tip, resulting in serious burns or other injury. An open drawer when hot may cause burns.



### WARNING

- **NEVER** cover any slots, holes or passages in the oven bottom or cover an entire rack with materials such as aluminum foil. Doing so blocks air flow through the oven and may lead to carbon monoxide poisoning. Aluminum foil linings may also trap heat, causing a fire hazard.
- **NEVER** use this appliance as a space or room heater. Doing so may result in carbon monoxide poisoning and cause the appliance to overheat.
- In case of fire or a gas leak, turn off the main gas shutoff valve.

# Important Safety Instructions



NE

- Do not attempt to repair or replace any part of this appliance unless specifically recommended in this manual. All other servicing should be done by a qualified technician.
- For safety reasons and to avoid damage to your appliance, never sit, stand or lean on the oven door.
- **DO NOT TOUCH SURFACE BURNERS OR THE INSIDE OF THE APPLIANCE:** Burners may be hot even though they are dark in color. The oven cavity can be hot enough to cause burns. During and after use, do not touch areas near burners or the inside of the oven until they have had sufficient time to cool. Do not allow garments or any flammable material to come into contact with hot surfaces. If personal clothing or hair catches on fire, drop to the floor immediately and roll to extinguish the flames.
- **WEAR PROPER APPAREL:** loose-fitting or hanging garments should never be worn while using the appliance.
- **DO NOT USE WATER ON GREASE FIRES:** Turn the appliance off and smother the fire with baking soda or use a dry chemical or a foam-type extinguisher.
- **USE ONLY DRY POTHOLDERS:** Moist or damp potholders on hot surfaces may cause burns from steam. Do not allow potholders to touch hot surface burners. Do not use towels or other bulky cloth in place of potholders.
- **DO NOT HEAT UNOPENED FOOD CONTAINERS:** A buildup of pressure can cause the containers to burst.
- **USE CAUTION WHEN OPENING THE OVEN DOOR:** Allow hot air or steam to escape before removing or placing foods in the oven.
- Do not attempt to operate the oven during a power failure. If the power fails, always turn the off the oven. If the oven is not turned off and the power resumes, the oven may begin to operate again. Food left unattended could catch fire or spoil.



## Important Safety Instructions

- Electronic controllers can be damaged by cold temperatures. When using the appliance for the first time, or when the appliance has not been used for a long time, make sure that the unit has been in temperatures above 32°F/ 0°C for at least 3 hours before turning power on to the appliance.
- Adjust the size of the surface burner flame so it does not extend beyond the edge of the cooking utensil. An excessive flame is hazardous.
- Do not use stove top grills on the burner grates of sealed gas burners. If you use a stove top grill on a sealed gas burner, it will cause incomplete combustion and can result in exposure to carbon monoxide levels above allowable current standards.
- Know which knob controls each surface burner. Place a pan of food on the burner before turning it on, and turn the burner off before removing the pan.
- **IMPORTANT:** After a spill or boilover, turn off the burner and clean around it. After cleaning, check that the burner functions properly.
- Use the proper pan size. Select utensils having flat bottoms large enough to cover the surface burner. If the utensil is smaller than the burner, some of the flame will be exposed and may result in clothing catching fire. Correct pan size will also improve efficiency.
- To reduce the risk of burns, ignition of flammable materials, and spillage due to unintentional contact with the utensil. The handle of the utensil should be positioned so that it is turned inward and does not extend over adjacent surface burners.
- Never leave the cooker unattended when using high heat settings. Boilover can cause smoke and spattered grease can ignite.
- Prevent aluminum foil from contacting the heating elements.



## Important Safety Instructions



- Not all types of glass, thermally resistant glass-ceramic, ceramic, earthenware, or other glazed cookware are suitable for cooker use. This type of cookware can break with sudden temperature changes. Use only on low or medium heat settings in accordance with the instructions supplied by the manufacturer.
- Air curtains or other overhead cooker hoods, which operate by blowing air downwards onto a cooker, shall not be used in conjunction with gas cookers other than when the hood and cooker have been designed, tested and listed by an independent test laboratory for use in combination with each other.
- Do not use a Searing Grill on the cooktop. The searing grill is not designed for use on the cooktop. Doing so may result in a fire.
- Do not obstruct oven vents or openings for air intake.
- Do not use decorative surface burner covers. If a burner is turned on accidentally, the decorative cover will become hot and possibly melt. Touching the hot covers may cause burns.
- The cooktop or burners may also become damaged because the covers may cause overheating. Air will be prevented from reaching the burner and cause combustion problems.
- Do not place plastic or heat-sensitive items on or near the oven vent. These items could melt or ignite.
- **PLACE THE OVEN RACKS IN THE DESIRED POSITION WHILE THE OVEN IS COOL:** If a rack has to be removed while the oven is hot, do not allow the potholders to come in contact with the broiler burner.
- Always check that the controls are in the "zero" (off) position when the cooker is not in use.
- Use only pots or pans with a perfectly smooth, flat bottom on the cooktop burners. **NEVER USE THE COOKTOP AS A WORK SURFACE.**
- Never allow garments, potholders or other flammable materials to come into direct or indirect contact with burners until they have completely cooled.



## Important Safety Instructions

- Do not use a broiler pan without its insert. The broiler pan and grid allow dripping fat to drain and be kept away from the high heat of the broiler.
- In the event of an electrical power outage, the surface burners can be lit manually. To light a surface burner, hold a lit match to the burner head and slowly turn the Surface Control knob to LITE. Use caution when lighting surface burners manually.
- Do not cover the broiler or warmer drawer (if provided) grid with aluminum foil. Exposed fat and grease could ignite.
- Do not touch the heating elements inside the oven.
- Do not use the oven as a storage space. This creates a potentially hazardous situation.
- Do not store or use gasoline or other flammable vapors and liquids near this or any other appliance. Explosions or fires could result.
- To eliminate the need to reach over the surface burners, cabinet storage space above the burners should be avoided.
- **BEFORE BAKING OR BROILING FOR THE FIRST TIME**, turn on the oven and broiler to burn off any dirt, oil or grease remaining from the manufacturing process. Turn the oven on and set to 450°F (230°C) for 20 to 30 minutes, then turn on the broiler for the same amount of time.

### **Cleaning and maintenance instructions**

- Be sure all range burner controls are turned off and that the cooktop is cool before using any type of cleaning product. The chemical elements in these products could, in the presence of heat, ignite or cause corrosion of metal parts.
- **DO NOT USE FLAMMABLE PRODUCTS TO CLEAN THE COOKER.**

# Important Safety Instructions



- Do not clean, rub, damage or remove the oven door gasket. It is essential for a good, tight seal during baking and when the self-clean cycle is engaged. Replace the oven door gasket if it becomes damaged or encrusted with food residues.
- **ONLY QUALIFIED SERVICE PERSONNEL SHOULD PERFORM REPAIRS.** Service personnel must disconnect the power supply before servicing this unit.
- Unlike the standard gas cooker, **THIS COOKTOP IS NOT REMOVABLE.** Do not attempt to remove the cooktop.
- Do not touch the halogen light bulb directly with your fingers, but wrap it in insulating material.

## State of California Proposition 65



### WARNING

Cancer or Reproductive Harm -  
[www.P65Warnings.ca.gov](http://www.P65Warnings.ca.gov)



### WARNING

Do not repair, replace or remove any part of the appliance unless specifically recommended in the manuals. Improper installation, service or maintenance can cause injury or property damage. Refer to this manual for guidance. All other servicing should be done by an authorized service provider.

- Make sure that your cooker is properly secured and the anti-tip device is correctly installed. Refer to the instructions in the installation manual.



## Important Safety Instructions

This appliance has been tested and found to comply with the limits for a class B digital device, pursuant to Part 18 of the FCC rules (United States) and ICES-001 (Canada). These limits are designed to provide reasonable protection against harmful interference in a residential installation. This unit uses and can radiate radio frequency energy that may interfere with radio communications if not installed and used in accordance with the instructions manual. However, there is no guarantee that interference will not occur in a particular installation. If this unit does cause interference to radio or television reception, which can be determined by turning the unit off and on, the user is encouraged to try to correct the interference by one or more of the following measures:

- Reorient or relocate the receiving antennas.
- Increase distance between unit and receiver.
- Connect the unit into an outlet or a circuit different from the one to which the receiver is connected.

### How to read the user manual

This user manual uses the following reading conventions:

#### Instructions



General information on this user manual, on safety and final disposal.

#### Description



Description of the appliance and its accessories.

#### Use



Information on the use of the appliance and its accessories, cooking advice.

#### Cleaning and maintenance



Information for proper cleaning and maintenance of the appliance.



Safety instructions



Information



Advice

1. Use instruction sequence.

- Single use instructions.

**SAVE THESE INSTRUCTIONS**



## 1 Description

### 1.1 General Description

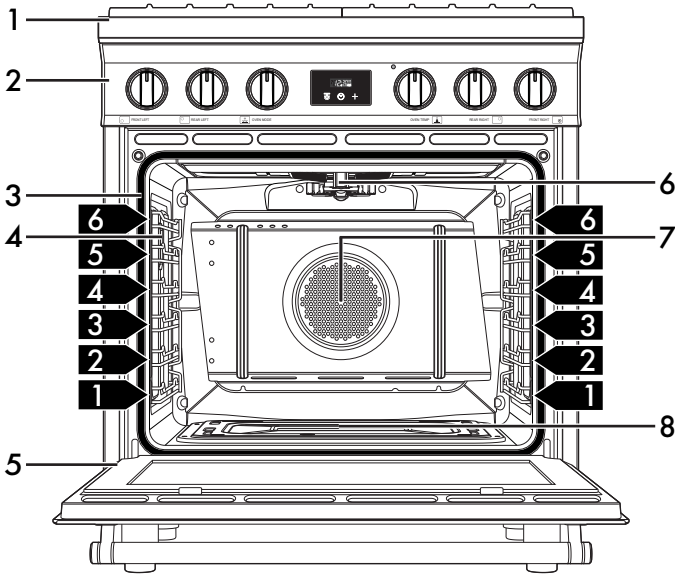

1 Cooktop

2 Control panel

3 Seal

4 Oven light

5 Door

6 Broiler

7 Fan

8 Oven

**1,2,3** Rack/tray support frame shelf



# Description

## 1.2 Cooktop

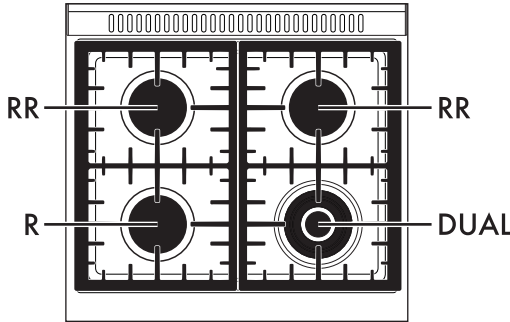

RR = Reduced-rapid

R = Rapid

DUAL = Ultra-rapid

## 1.3 Control panel

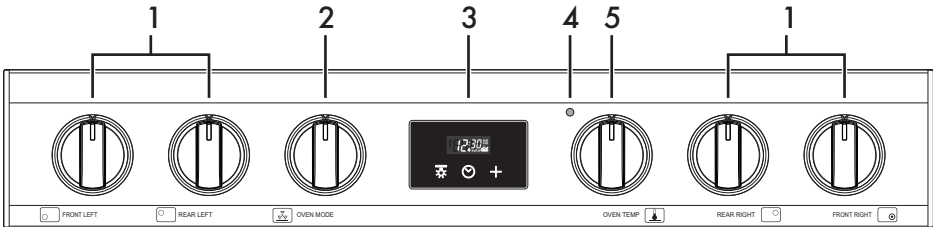

### 1 Cooktop burner knobs

Used for lighting and adjusting the burners. The following markings appear on each cooktop knob:

**OFF** burner OFF position;

burner electric ignition;

**MAX** burner MAX flame setting;

**MIN** burner MIN flame setting.

On the DUAL cooktop knob:

burner outer and inner ring flame setting;

burner inner ring flame setting.

### 2 Function knob

The oven's various functions are suitable for different cooking modes. After selecting the required function, set the cooking temperature using the temperature knob.

### 3 Programmer clock

Used for displaying the current time, setting the timer, and turn the light inside the appliance on/off.



## 4 Hot oven indicator light



### CAUTION

High temperature inside the oven.

The indicator light comes on to indicate that the oven is hot. Each time the indicator light comes on, the appliance emits an acoustic signal.

Depending on the set temperature (from 250 to 500°F) it will activate after about 10-12 minutes of operation.

It switches off when the oven cavity has cooled down.



**NOTE:** In Broil mode, the indicator light remains off. It lights up at the end of the function during the cooling phase to indicate that the oven is still hot.

## 5 Temperature knob

This knob allows you to select the cooking temperature. Turn the knob clockwise to the required value between the minimum and maximum settings.

## 1.4 Other parts

### Shelves

The appliance is fitted with shelf supports to position trays and racks at different heights. The insertion heights are indicated from the bottom upwards (see 1.1 General Description).

### Oven cavity lighting

The internal lighting of the device is turned on/off only by pressing the decrease value button .

### Cooling fan

The fan cools the oven and comes into operation during cooking.

The fan causes a steady outflow of air that exits from the rear of the appliance, which may continue for a brief period of time even after the appliance has been turned off.

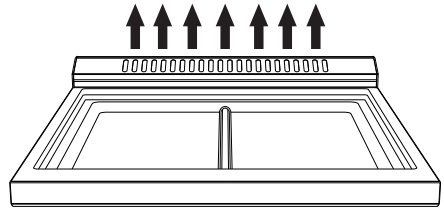

**NOTE:** Do not obstruct ventilation openings and heat dispersal slots.



## Description

### 1.5 Available accessories

#### Rack

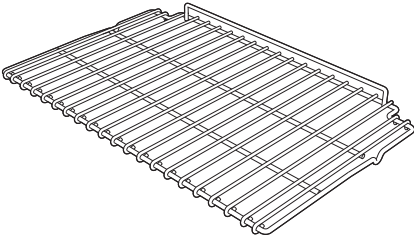

Used to hold containers containing food to be cooked.

#### WOK ring (not included)

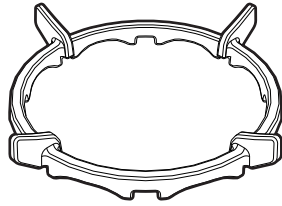

Useful when using a wok.



**NOTE:** Some models are not provided with all accessories.



**NOTE:** The accessories intended to come into contact with food are made of materials that comply with the provisions of current legislation.



**NOTE:** Supplied and optional can be requested from Authorized Assistance Centers. Use only original accessories supplied by the manufacturer.





## 2 Use

### 2.1 Instructions



#### WARNING

##### Danger of burns

##### High temperature inside the oven during use

- Keep the oven door closed when the appliance is in use.
- Protect your hands by wearing oven gloves when moving food inside the oven.
- Do not touch the heating elements inside the oven.
- Do not pour water directly onto very hot trays.
- Keep children under the age of 8 away from the appliance when it is in use.
- If you need to move food or at the end of cooking, open the door 5 cm for a few seconds, let the steam come out, then open it fully.



#### WARNING

##### Danger of burns

##### Improper use

- Make sure that the flame-spreader crowns are correctly positioned in their seats with their respective burner caps.
- Oils and grease could catch fire if overheated. Be very careful.



#### CAUTION

##### Risk of damage to surfaces

##### Improper use

- Do not cover the bottom of the oven cavity with aluminum or tin foil sheets.
- If you wish to use greaseproof paper, place it so that it will not interfere with the hot air circulation inside the oven.
- Do not place pans or trays directly on the bottom of the oven cavity.
- Do not use the open door to rest pans or trays on the internal glass pane.
- Do not pour water directly onto very hot trays.
- Cooking vessels or griddle plates should be placed inside the perimeter of the cooktop.
- All pans must have smooth, flat bottoms.
- If any liquid does boil over or spill, remove the excess from the cooktop.



#### WARNING

##### Danger of burns

##### High temperature inside the storage compartment.

- Do not open the storage compartment when the appliance is on and still hot.
- The items inside the storage compartment could be very hot after using the appliance.



## WARNING

### **Danger of fire or explosion**

#### **High temperature inside the oven during use**

- Do not spray any products near the appliance.
- Do not use or leave flammable materials near the appliance or the storage compartment.
- Do not use plastic cookware or containers when cooking food.
- Do not put sealed tins or containers in the oven.
- Do not leave the appliance unattended during cooking operations where fats or oils could be released.
- Remove all trays and racks which are not required during cooking.

### **A gas leak can cause an explosion.**

If you smell gas or there are faults in the gas system:

- Immediately turn off the gas supply or close the valve on the gas cylinder.
- Extinguish all naked flames and cigarettes.
- Do not turn on power switches or appliances and do not remove plugs from power sockets. Do not use phones or mobile phones inside the building.
- Open the window in order to ventilate the room.
- Call customer assistance services or your gas supplier.

## **Malfunctions**

Any of the following indicate a malfunction and you should contact a service center.

- Yellowing of the burner plate.
- Damage to kitchen utensils.
- The burners do not ignite properly.
- It is difficult to keep the burners lit.
- The burners go out when the appliance is in use.
- It is difficult to turn the gas valves.

If the appliance does not work properly, contact your local Authorized Assistance Center.

## **First-time use of the range**

1. Remove any protective film from the outside or inside of the appliance, including accessories.
2. Remove any labels (apart from the technical data plate) from the accessories and from the oven cavity.
3. Remove and wash all the appliance accessories (see 3 Cleaning and maintenance).
4. Heat the empty appliance to the maximum temperature to burn off any residues left by the manufacturing process.



## 2.2 Using the accessories

### Racks and trays

Racks and trays have to be inserted into the side guides until they come to a complete stop.

The mechanical safety locks that prevent the rack from being taken out accidentally have to face downwards and towards the oven back.

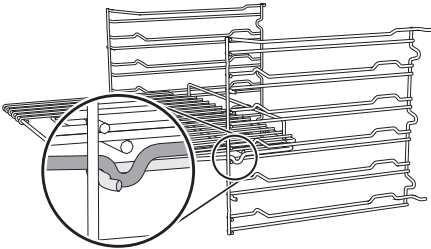

**NOTE:** Gently insert racks and trays into the oven until they come to a stop.



**NOTE:** Clean the trays before using them for the first time to remove any residues left by the manufacturing process.

### WOK ring (not included)

The WOK ring reducer has to be placed on the cooktop grates. Make sure it is properly placed.

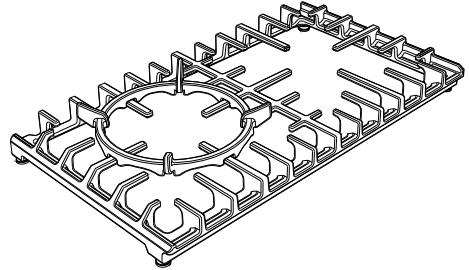

**NOTE:** For best results, we recommend using the WOK rack only on the Ultra-rapid DUAL burner.



**NOTE:** If a WOK ring is used on the Ultra-rapid DUAL burner, the right rear Reduced-rapid burner must be left off.



## 2.3 Using the cooktop



### WARNING

#### Fire Hazard

- For your safety: do not allow the burner flame to extend beyond the edge of the pan.

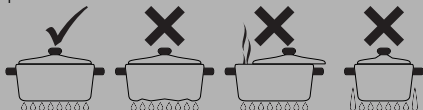

- Turn off all controls when the cooktop is not in use.

All the appliance's control and monitoring devices are located together on the front panel. The burner controlled by each knob is shown next to the knob. The appliance is equipped with an electronic ignition device. Simply press the knob and turn it counter-clockwise to the maximum flame symbol until the burner lights. If the burner does not light in the first 15 seconds, turn the knob to **OFF** and wait 5 minutes before trying again.

After lighting, keep the knob pressed in for a few seconds to allow the thermocouple to heat up. The burner may go out when the knob is released: in this case, the thermocouple has not heated up sufficiently. Wait a few moments and repeat the operation. Keep the knob pressed in longer.



**NOTE:** If it is turned off by accident, a safety device will trip, shutting off the gas supply, even if the gas tap is open. Return the knob to **OFF** and wait at least 5 minutes before lighting it again.

### To operate the cooktop burners

1. Press and turn the knobs counter-clockwise to the value  to light the relative burners.
2. Turn the knobs to the zone between **MAX** and **MIN** to adjust the flame.
3. Return the knobs to the **OFF** position to turn off the burners.



## Setting the DUAL flame size



**NOTE:** The inner ring will be lit when you light the outer ring on either high or low flame settings. It is not possible to light the outer ring without lighting the inner one.

Refer to the following diagrams:

### Outer ring

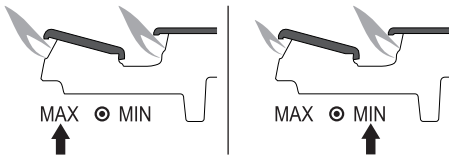

### Inner ring

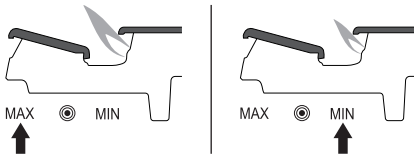

## Simmer function



**NOTE:** This function is extremely useful for melting food like butter, chocolate or similar and for simmering small quantities of food.

1. Switch on the DUAL burner internal cup.
2. Set the flame to the minimum.
3. Leave the external cup off.



**NOTE:** If the external cup switches on at full power, set half power at least for the internal cup.

## Correct positioning of the flame-spreader crowns and burner caps

Before lighting the cooktop burners, make sure that the flame-spreader crowns are correctly positioned in their seats with their respective burner caps. Make sure that the holes **1** of the flame-spreader crowns **2** are aligned with the thermocouples **3** and igniters **4**.

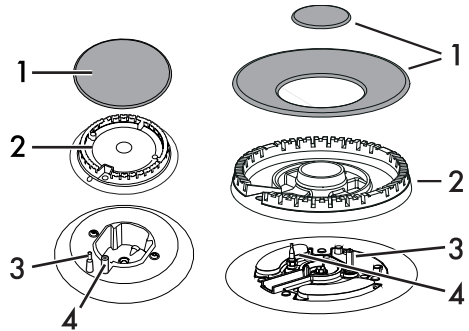



## Use

### Practical tips for using the cooktop

For better burner efficiency and to minimize gas consumption, use pans with lids and of suitable size for the burner so that the flames do not reach up the sides of the pan. Once the contents come to the boil, turn down the flame far enough to ensure that the liquid does not boil over.

### Cookware diameters

Burner	Ø min. - max.	
	inches	cm
RR - R	$7 \frac{1}{8} - 9 \frac{7}{16}$	18 - 24
DUAL	$7 \frac{1}{8} - 10 \frac{1}{4}$	18 - 26

### Cookware

Ideally, cookware should have a flat bottom, straight sides, a tight-fitting lid and medium-to-heavy thickness.

Rough cookware finishes may scratch the cooktop. Aluminum and copper may be used in cookware as a core material or for the base. However, when used as a base they can leave permanent marks on the cooktop or grates.

Cookware properties are a factor in how quickly and evenly heat is distributed, which affects cooking results. A non-stick finish has the same characteristics as its base material. For example, a non-stick finish on aluminum cookware will take on the properties of aluminum.

Refer to the following chart as a guide to the physical properties of cookware.

### Aluminum

- Heats quickly and evenly.
- Suitable for all types of cooking.
- Medium or heavy thickness is best for most cooking tasks.

### Cast iron

- Heats slowly and evenly.
- Good for browning and frying.
- Maintains heat for slow cooking.

### Ceramic or glass-ceramic

- Follow the manufacturer's instructions.
- Heats slowly but unevenly.
- Best results with low to medium heat settings.

### Copper

- Heats very quickly and evenly.

### Earthenware

- Follow the manufacturer's instructions.
- Use low heat settings.

### Porcelain enameled steel or cast iron

- See stainless steel or cast iron.

### Stainless steel

- Heats quickly but unevenly.
- Stainless steel cookware with an aluminum or copper core or bottom provides even heating.



## 2.4 Using the oven



### WARNING

#### Fire Hazard

- Keep the oven door closed when the appliance is in use.



**NOTE:** If there is no power, the cooling fan will not work. Do not try to switch on the oven manually.

### Checking the power supply

Before manually lighting the gas oven burner, you should check that there is power to the appliance.

After connecting the appliance to the mains power, rotate the function knob to the **LIGHT** position to switch on the internal lighting of the appliance.

## 2.5 Programming clock

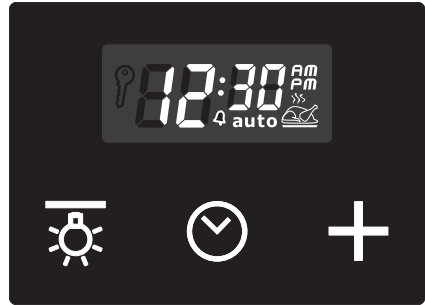

Value decrease key



Clock key



Value increase key



Ensure that the programmer clock shows the cooking duration symbol , otherwise it will not be possible to turn on the oven.



Press the key  to reset the programmer clock.







## Setting the time

**i** If the time is not set, the oven will not switch on.

On the first use, or after a power failure, the digits  will be flashing on the appliance's display.

1. Keep the clock key  pressed for two seconds. The dot between the hours and the minutes flashes.
2. The time can be set using the value increase key  and value decrease key . Keep the key pressed in to increase or decrease rapidly.
3. Wait 7 seconds. The dot between the hours and the minutes stops flashing.







The symbol  on the display indicates that the appliance is ready to start cooking.

 To change the time, hold down the value increase key  and value decrease key  at the same time for two seconds, then set the time.

## Minute minder timer

**i** The minute minder timer does not stop the cooking operation but informs the user when the set time has run out.



The minute minder timer can be activated at any time.

1. Keep the clock key  pressed for a few seconds. The display shows the figures  and the symbol  flashing between the hours and minutes.
2. Use the value increase  and value decrease  keys to set the number of minutes required.
3. Wait approx. 5 seconds without pressing any key to finish setting the minute minder. The current time and the symbol  appear on the display.
4. A buzzer will sound when the set time is reached.
5. Press the value decrease key  to turn the buzzer off.

**i** The minute minder timer can be set from 1 minute to a maximum of 23 hours and 59 minutes.

## 12h or 24h format

The default mode is 12h format.

1. Keep the value increase key  for a few seconds. The symbols  or







**PM** disappear on the display and 24h format is set.

- Keep the value increase key  pressed for a few seconds to go back to the 12h format.

### Selecting the buzzer

The buzzer can have 3 tones.

- Hold down the value increase  and value decrease  keys at the same time.
- Press the clock key . The digit

 appears on the display.

- Press the value decrease key  to select a different buzzer tone

( or ).

### Using the gas oven

Electronic spark ignition:

- Push in zero position up to the mechanical stop for at least 2 seconds (the sparking will be heard) and rotate the temperature knob to between 250°F and 500°F (120°C and 260°C). This automatically activates the electric spark igniter.



**NOTE:** If the burner does not ignite after 15 seconds, stop attempting to light it, leave the oven door open and do not try to light it again for at least 60 seconds.



**NOTE:** If the burner is turned off unintentionally, turn the knob to the off position and do not try to light the burner again for at least 60 seconds.



## Using the broiler



### WARNING

#### Danger of fire or explosion

High temperature inside the oven during use

- Grilling should never last more than 30 minutes.

Electronic spark ignition:

- Push in zero position up to the mechanical stop for at least 2 seconds (the sparking will be heard) and rotate the temperature knob clockwise to **BROIL**. This automatically activates the electric spark igniter.



**NOTE:** The oven and the broiler must never be used at the same time.

## Functions list

### CONV BOTTOM

The combination of the fan with the bottom heating element only allows cooking to be completed more rapidly. This system is recommended for sterilizing or for finishing off the cooking of foods which are already well-cooked on the surface, but not inside, and therefore need a little more heat.

Perfect for any type of food.

### DEFROST (Rapid)

Rapid defrost is assisted by the activation of a fan to ensure uniform distribution of room temperature air inside the oven. This function can be used for any type of food.

### BROIL

Using the heat released from the central part of the broiler element, this function allows you to broil small portions of meat and fish for making kebabs, toasted sandwiches, and any type of grilled vegetable side dishes



## 2.6 Cooking advice

### General advice

- Use pans/trays with a maximum width of 33-35 cm.
- It is not possible to shorten cooking times by increasing the temperature (the food could be overcooked on the outside and undercooked on the inside).
- It is recommended to preheat the oven before baking.
- Using several ovens at the same time might affect the final cooking results.

### Advice for cooking meat

- Cooking times vary according to the thickness and quality of the food and to consumer taste.
- Turn the food to brown both sides.
- Use a meat thermometer when roasting meat, or simply press on the roast with a spoon. If it is hard, it is ready; if not, it needs another few minutes cooking.

### Advice for cooking with the Broiler

- Meat can be grilled even when it is put into a cold oven or into a preheated oven if you wish to change the effect of the cooking.
- When using the Broil function, preheat the oven for 15 minutes before cooking. Cooking times may vary depending on the thickness of the food.
- We recommend placing the food at the center of the rack.

- Foods should be seasoned before cooking. Foods should also be coated with oil or melted butter before cooking.
- Use the oven tray on the first bottom shelf to collect fluids produced by grilling.

### Advice for cooking desserts and biscuits

- Temperature and cooking time depend on the quality and consistency of the dough.
- To check whether the dessert is cooked right through, at the end of the cooking time, put a toothpick into the highest point of the dessert. If the batter does not stick to the toothpick, the dessert is done.
- If the dessert collapses when it comes out of the oven, on the next occasion reduce the set temperature by about 50°F, selecting a longer cooking time if necessary.
- While cooking desserts or vegetables, excessive condensation may form on the glass. In order to avoid this, open the door very carefully a couple of times while cooking.

### Tips for cooking on two shelves:

- Use a fan-assisted function to achieve uniform cooking at several levels. Use shelves 2 and 4.
- It is recommended to use 2 racks (can be requested from Authorized Assistance Centers).



## Use

- To facilitate the flow of air, place the molds/pans in the center of the racks and make sure that their width/diameter does not exceed 11".
- Position the racks keeping an empty level between them.
- Depending on the food and the increased load in the oven, cooking on two levels may take a few minutes longer than on a single shelf.
- The functions indicated for cooking on two shelves are THERMO-FAN-ASSISTED and THERMO-FAN-ASSISTED BASE.

### Advice for defrosting and proving

- Place frozen foods without their packaging in a lidless container on the first shelf of the oven.
- Avoid overlapping the food.
- To defrost meat, use a rack placed on the second level and a tray on the first level. In this way, the liquid from the defrosting food drains away from the food.
- The tenderest parts of the food can be protected with aluminum foil.
- For successful rising, a container of water should be placed at the bottom of the oven.

### To save energy

- Unless otherwise indicated on the packaging, defrost frozen food before placing it in the oven.
- In case of multiple cooking, it is advisable to cook the products one after the other to make the most of the already hot oven.
- Use preferably dark metal molds: they help to absorb the heat better.
- Remove all trays and racks which are not required during cooking.
- Stop cooking a few minutes before the time normally used. Cooking will continue for the remaining minutes with the heat that has accumulated inside the oven.
- Reduce any opening of the door to a minimum to avoid heat dispersal.
- Keep the inside of the appliance clean at all times.



## Cooking information table

Preh = preheating

Runner = position from the bottom

Food	Weight (Kg)	Runner	Function	Preh	Temperature (°F)	Time (minutes)
<b>MEAT</b>						
Whole chicken	2.5	2	FAN-ASSISTED	Yes	375	15 - 25
Roast loin*	1.5	2	STATIC	Yes	350	16 - 25

\* in a pan on a rack.

<b>DESSERTS</b>						
Sheet cake <sup>1</sup>	1.0	3	STATIC	Yes	350	30 - 35
Biscuits <sup>2</sup>	n.9 55 g each.	2	STATIC FAN-ASSISTED	Yes	350	19
Sugar cookies <sup>2</sup>	n.9 15 g each.	3	FAN-ASSISTED	Yes	375	8 - 12
Apple pie <sup>3</sup>	1.7 1.1 apple 0.6 dough	2	STATIC	Yes	375	55 - 60
Cupcakes <sup>4</sup>	n.12 50 g each.	3	STATIC	Yes	325	15 - 20

<sup>1</sup> in cake mold Ø 26 cm.

<sup>3</sup> in cake mold Ø 23/25 cm.

<sup>2</sup> flat tray 33 cm wide on rack.

<sup>4</sup> in muffin mold on oven rack.

<b>GRILLS</b>							1 <sup>st</sup> side	2 <sup>nd</sup> side
Hamburger*	n.4	140 g each. thickness 1 cm	5	Broil	15'	-	8	7
Sausages* cut and open in half	n.6	180 g each.	5	Broil	15'	-	7	6

\* food on rack with container underneath.

<b>VEGETABLES</b>						
Vegetables*	0.7	2 - 3	FAN-ASSISTED	No	recipe temp.	recipe time

\* in aluminum tray 28 x 30.

<b>FRESH DOUGHS</b>						
Pizza*	0.5 - 0.6	2	FAN-ASSISTED	Yes	MAX	10 - 14

\* in baking tray with low edge Ø 28/30 cm.

<b>FRESH FISH</b>						
Fish filets*	0.6	4	Broil	Yes	MAX	11-15 11-15

\* in a pan on a rack.

The times indicated in the table do not include preheating times and are provided as a guide only.



# Cleaning and Maintenance

## 3 Cleaning and maintenance

### 3.1 Instructions



#### WARNING

##### Electrical Shock Hazard

- Before servicing, disconnect the appliance from the power supply.



#### WARNING

##### Risk of damage to surfaces

###### Improper use

- Do not use steam jets to clean the appliance.
- Do not use cleaning products containing chlorine, ammonia or bleach on steel parts or parts with metallic finishes on the surface (e.g. anodizing, nickel- or chromium-plating).
- Do not use abrasive or corrosive detergents on glass parts (e.g. powder products, stain removers and metallic sponges).
- Do not use rough or abrasive materials or sharp metal scrapers.
- Do not wash the removable components such as the cooktop stand support, flame spreaders and burner caps in a dishwasher.
- Keep cooktop area clear and free from combustible materials, gasoline other flammable vapors and liquids.
- Do not obstruct the flow of combustion and ventilation air.

### Recommendations



**NOTE:** We recommend the use of cleaning products distributed by the manufacturer.

To keep the surfaces in good condition, they should be cleaned regularly after use. Let them cool first.

#### Regular daily cleaning

Always use only specific products that do not contain abrasives or chlorine-based acids.

Pour the product onto a damp cloth and wipe the surface, rinse thoroughly and dry with a soft cloth or a microfiber cloth.

#### Food stains or residues

Do not use metallic sponges or sharp scrapers as they will damage the surfaces.

Use ordinary non-abrasive products with the aid of wooden or plastic utensils if necessary. Rinse thoroughly and dry with a soft cloth or a microfiber cloth.

Do not allow residues of sugary foods (such as jam) to set inside the oven. If allowed to set for too long, sugar residue could pit the enamel lining of the oven.

#### Cooktop grates

Remove the grates and clean them with lukewarm water and non-abrasive detergent. Take care to remove any encrustations. Dry thoroughly and place them back on the cooktop.



## 3.2 Cleaning the cooktop

1. Pour some non-abrasive detergent on a damp cloth and wipe the surfaces.
2. Rinse thoroughly.
3. Dry with a soft cloth or a microfiber cloth.

### Cleaning cooktop grates, flame-spreader crowns and burner caps

1. Remove the components from the hob.
2. Clean with lukewarm water and non-abrasive detergent. Take care to remove any encrustations.
3. Dry thoroughly with a soft cloth or a microfiber cloth.
4. Replace the components on the cooktop.

- Remove any dry residue with a toothpick or needle.

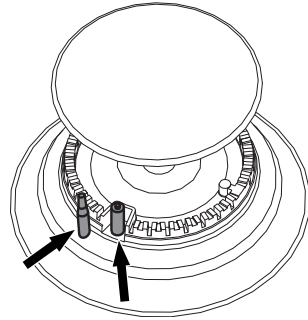

**i** **NOTE:** Continuous contact between the grates and the flame can lead to the enamel becoming modified on the parts exposed to heat. This is normal and has no effect on the operation of this component.

### Cleaning the igniters and thermocouples

- If necessary, clean the igniters and thermocouples with a damp cloth.

## 3.3 Cleaning the door

### Removing the oven door

To facilitate cleaning, we recommend that you remove the door and place it on a towel.

To remove the door, proceed as follows:

1. Open the door completely and insert two pins into the holes in the hinges, as shown in the image.

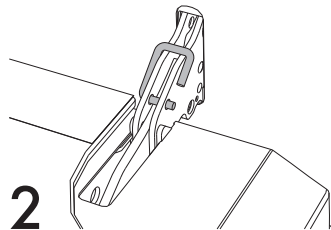
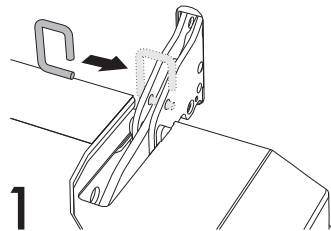



## Cleaning and Maintenance

2. Grasp the door on both sides with both hands, lift it forming an angle of around 30° and remove it.

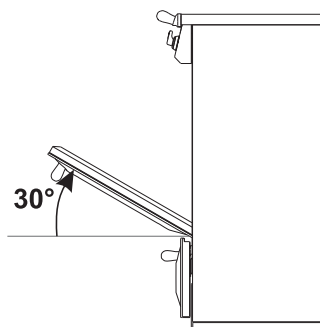

3. To reassemble the door, put the hinges in the relevant slots in the oven, making sure that the grooved sections **A** are resting completely in the slots. Lower the door and once it is in place remove the pins from the holes in the hinges.

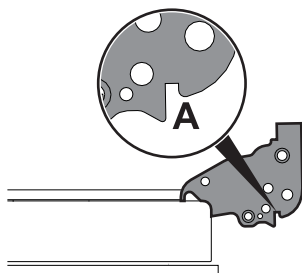

### Cleaning the oven door glass

The oven door glass should always be kept thoroughly clean. Use absorbent kitchen roll. In case of stubborn dirt, wash with a damp sponge and an ordinary detergent.

### Removing the inner glass

To facilitate cleaning, the inner glass panels of the door can be removed.

1. Remove the inner glass panel by pulling it gently upward at the rear, moving it as indicated by the arrows (1).

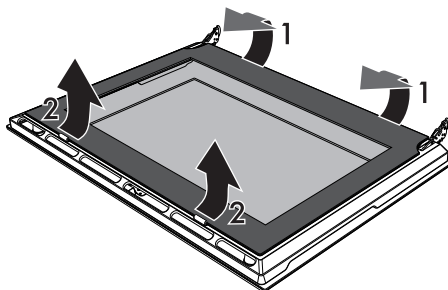

2. Then pull the front part of the glass panel upwards (2). This way, the four pins attached to the glass panel are disengaged from their grooves in the door.
3. Remove the intermediate glass pane by lifting it upwards.

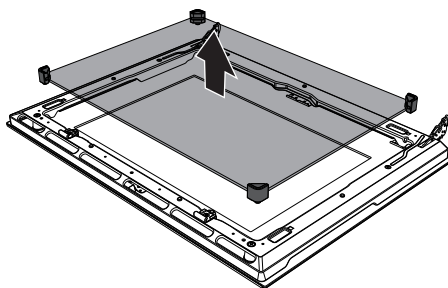





4. Clean the external glass panel and the one you just removed. Use paper towels. If there are tough to clean spots, use a damp sponge and mild detergent.

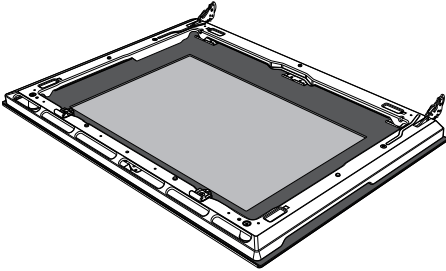

5. Reinsert the glass panels in the reverse order of removal.

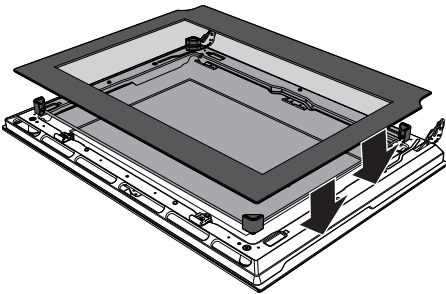

6. Replace the inner glass panel. Make sure you center and insert the four pins into their grooves in the door, using a little pressure.

## 3.4 Cleaning the oven cavity

In order to keep your oven in the best possible condition, clean it regularly after letting it cool down.

Avoid letting food residue dry inside the oven cavity, as this could damage the enamel.

Take out all removable parts before cleaning.

For easier cleaning, we recommend removing:

- the door;
- the rack/tray supports;
- removable guides, where fitted;
- the seal.



**NOTE:** If you use specific cleaning products, we recommend running the oven at maximum temperature for 15-20 minutes in order to eliminate any residues.



# Cleaning and Maintenance

## Removal of the rack/tray supports

Removing the guide frames makes it easier to clean the sides of the oven.

To remove the guide frames:

- Pull the frame towards the inside of the oven to unhook it from its housing **A**, and then slide it out of the grooves at the back **B**.

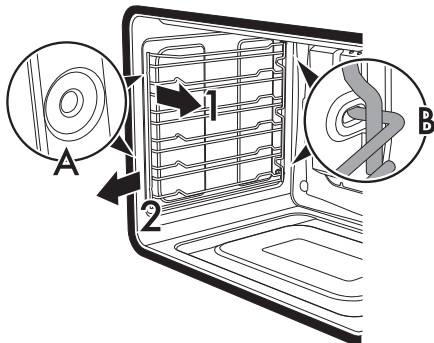

- When you have finished cleaning the oven, repeat the procedures indicated above in reverse to replace the guide frames.

## 3.5 Special maintenance

### Seal maintenance tips

The seal should be soft and elastic.

- To clean the seal, use a non-abrasive sponge and wash with lukewarm water.

## Replacing the internal light bulb



### WARNING

#### Danger of electrocution

- Unplug the appliance.
- Use protective gloves.



**NOTE:** The oven is fitted with one 40W light bulb.

1. Completely remove all accessories from inside the oven.
2. Remove the rack/tray supports.
3. Use a tool (e.g. a spoon) to remove the bulb cover.

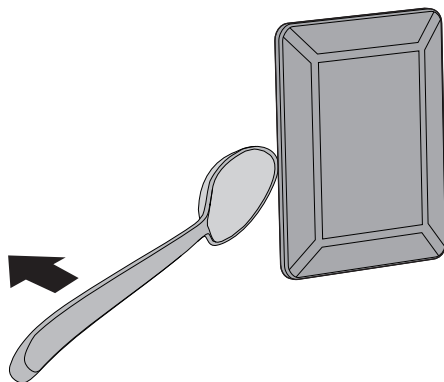

**NOTE:** Pay attention not to scratch the oven cavity enamel.



4. Loosen and remove the light bulb.

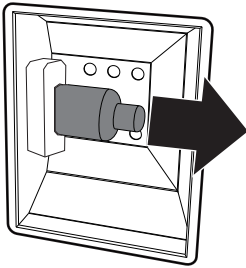

Do not touch the halogen bulb with your fingers; cover it with an insulating cloth.

5. Replace the bulb with a similar one (40 W).
6. Reattach the cover. Leave the inside of the glass molding (**A**) facing the door.

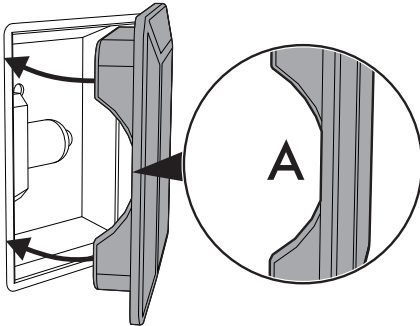

7. Press the cover firmly so that it adheres tightly to the light bulb holder.

## Lubricating the surface burner gas valves

Over time, the surface burner gas valves may become stiff or jam. Clean them internally and re-lubricate. This operation must be carried out by a qualified technician.

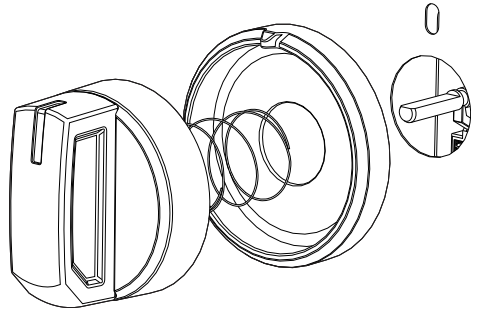

NE

PAGE INTENTIONALLY LEFT BLANK