

SPR30UGGX

Range size	30"
Cooktop type	Gas
Main oven	Gas with grill
EAN code	8017709304423



Aesthetic



Series	Professional	Control knobs	Pro-style control knobs
Color	Stainless steel	No. of controls	6
Finishing	Satin	Silkscreen color	Black
Control panel finish	Stainless steel	Display	Touch
Logo position	Fascia below the oven	Handle	Robust knurled handle
Cooktop color	Black enamel	Handle color	Brushed stainless steel
Grates	Cast Iron	Feet	Stainless steel
Control setting type	Control knobs		

Programs / Functions

No. of cooking functions 3

Traditional cooking functions

 Large grill	 Bottom	 Convection bottom
--	--	---

Other functions

 Defrost by time
--

Cooktop technical features

Cooking zones 4
 Front-left - 3510 W - 12000 BTU

Rear-left - 2930 W - 10000 BTU
 Rear-right - 2930 W - 10000 BTU
 Front-right - 5270 W - 18000 BTU

Automatic gas ignition	Yes	Burner caps	Enameled matte black
Gas safety valves	Yes		

Main Oven Technical Features



No. of lights	1	Light on when door is open	Yes
Fan number	1	Removable door	Yes
Volume	4.56 cu. ft.	Total no. of door glasses	3
Cavity material	EverClean enamel	Cooling system	Tangential
No. of shelves	6	Grill type	Gas
Light type	Halogen	Soft Close system	Yes
Light Power	40 W		

Main oven options

Minimum Temperature	250 °F	Maximum temperature	500 °F
----------------------------	--------	----------------------------	--------

Accessories included for main oven and cooktop

Oven wire rack	2
-----------------------	---

Electrical Connection

Plug	(B) NEMA 5-15P	Type of electric cable installed	Yes, Single phase
Current	15 A	Power cord length	59 1/16 "
Circuit breaker	15 A	Frequency	60 Hz
Voltage	120 V	Terminal block	3 pins

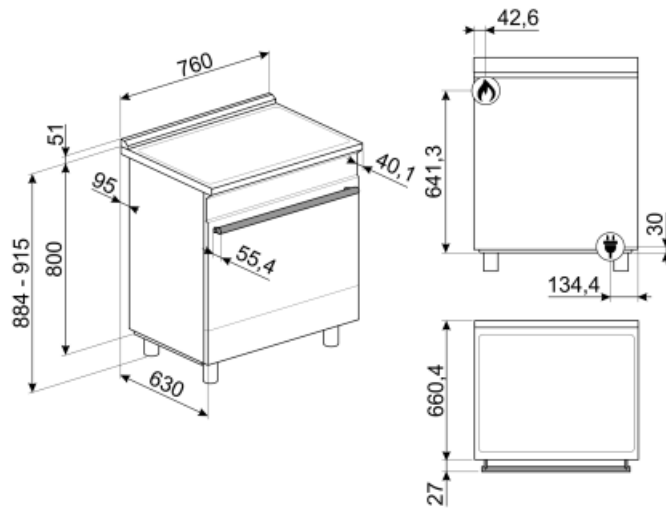

Not included accessories



SFLK1
Child lock



GT3T



GRM
Gas hobs moka support



PALPZ
Pizza shovel with fold away handle
width: 315mm length : 325mm



PRTX
Refractory pizza stone with handles.
D=35cm Not suitable for microwave
ovens. Suitable for gas ovens, to be
put on the griddle.

















WOKGHU
Cast-Iron WOK Support



KITTKSPR30
Plinth, 3 sides, 900mm , SPR cookers
30", black

Symbols glossary (TT)

 <p>Heavy duty cast iron pan stands: for maximum stability and strength.</p>	 <p>Installation in column: Installation in column</p>
 <p>Knobs control</p>	 <p>Air cooling system: to ensure a safe surface temperatures.</p>
 <p>Defrost by time: with this function the time of thawing of foods are determined automatically.</p>	 <p>...</p>
 <p>Triple glazed doors: Number of glazed doors.</p>	 <p>Enamel interior: The enamel interior of all Smeg ovens have a special antacid lining which helps keep the interior clean by reducing the amount of cooking grease adhering to it.</p>
 <p>Circogas: In gas ovens the fan distributes the heat quickly and evenly throughout the oven cavity, avoiding flavour transfer when cooking a number of different dishes at the same time. In electric ovens this combination completes cooking more quickly of foods that are ready on the surface, but that require more cooking inside, without further browning.</p>	 <p>Lower heating element only: This function is ideal for foods that require extra base temperature without browning, e.g. pastry dishes, pizza. Also suitable for slow cooking of stews and casseroles.</p>
 <p>Grill element: Using of grill gives excellent results when cooking meat of medium and small portions, especially when combined with a rotisserie (where possible). Also ideal for cooking sausages and bacon.</p>	 <p>Gas ovens offer instantaneous heat control, reduced cooking times and the ability to bake at much lower temperatures than electric ovens.</p>
 <p>Side lights: Two opposing side lights increase visibility inside the oven.</p>	 <p>The oven cavity has 6 different cooking levels.</p>
 <p>Soft close: all models are equipped with advanced function of smooth closing of the door, which allows the device to close smoothly and quietly.</p>	

Benefit (TT)

Gas hob

Induction offers fast cooking and precise temperature control

Equipped with a thermocouple, the gas supply is cut off if the flame is extinguished for greater safety

Touch control

Easy and intuitive timer setting with a single touch

Single turbine

The oven has a fan equipped with a circular heating element allowing cooking with rotating heat

Isothermic Cavity

The best cooking performance at the highest energy efficiency

Tangential cooling

New cooling system with tangential fan and airflow from the door to the splashback

Soft close

The door is equipped with a specific system for silent closing

Multilevel halogen light

Internal halogen lighting on different levels guarantees excellent visibility

Adjustable height

Cooker top flushed with the working area thanks to adjustable feet

Multilevel cooking

Several cooking levels allow maximum flexibility of use

Cold door

During any function, the external door glass is cold, avoiding any risk of burns

AirFry (AIRFRY optional accessory)

Lighter and tastier food thanks to airfry basket

BBQ (optional accessory)

Barbeque cooking directly in the oven with the double-sided grill

Pizza stone (optional accessory)

Baking with refractory stone for soft and crispy pizza and yeast products (STONE optional accessory)