

# SPR36UGGX

|              |                |
|--------------|----------------|
| Range size   | 36"            |
| Cooktop type | Gas            |
| Main oven    | Gas with grill |
| EAN code     | 8017709304805  |



## Aesthetic



|                             |                       |                             |                         |
|-----------------------------|-----------------------|-----------------------------|-------------------------|
| <b>Series</b>               | Professional          | <b>Control setting type</b> | Control knobs           |
| <b>Color</b>                | Stainless steel       | <b>Control knobs</b>        | Pro-style control knobs |
| <b>Finishing</b>            | Satin                 | <b>No. of controls</b>      | 8                       |
| <b>Control panel finish</b> | Stainless steel       | <b>Silkscreen color</b>     | Black                   |
| <b>Logo</b>                 | Assembled             | <b>Display</b>              | Touch                   |
| <b>Logo position</b>        | Fascia below the oven | <b>Handle</b>               | Robust knurled handle   |
| <b>Cooktop color</b>        | Black enamel          | <b>Handle color</b>         | Brushed stainless steel |
| <b>Grates</b>               | Cast Iron             | <b>Feet</b>                 | Stainless steel         |

## Programs / Functions

No. of cooking functions 3

Traditional cooking functions



Other functions

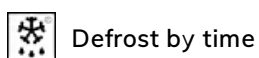

## Cooktop technical features

Cooking zones 6  
Front-left - 5270 W - 18000 BTU

Rear-left - 2930 W - 10000 BTU  
 Front-center - 2930 W - 10000 BTU  
 Rear-center - 2930 W - 10000 BTU  
 Front-right - 5270 W - 18000 BTU  
 Rear-right - 2930 W - 10000 BTU

|                               |     |                    |                      |
|-------------------------------|-----|--------------------|----------------------|
| <b>Automatic gas ignition</b> | Yes | <b>Burner caps</b> | Enameled matte black |
| <b>Gas safety valves</b>      | Yes |                    |                      |

## Main Oven Technical Features



|                        |                  |                                   |            |
|------------------------|------------------|-----------------------------------|------------|
| <b>No. of lights</b>   | 1                | <b>Light on when door is open</b> | Yes        |
| <b>Fan number</b>      | 1                | <b>Removable door</b>             | Yes        |
| <b>Volume</b>          | 4.45 cu. ft.     | <b>Removable inner door</b>       | Yes        |
| <b>Cavity material</b> | EverClean enamel | <b>Total no. of door glasses</b>  | 3          |
| <b>No. of shelves</b>  | 5                | <b>Cooling system</b>             | Tangential |
| <b>Light type</b>      | Halogen          | <b>Grill type</b>                 | Gas        |
| <b>Light Power</b>     | 40 W             | <b>Soft Close system</b>          | Yes        |

## Main oven options

|                            |        |                            |        |
|----------------------------|--------|----------------------------|--------|
| <b>Minimum Temperature</b> | 250 °F | <b>Maximum temperature</b> | 500 °F |
|----------------------------|--------|----------------------------|--------|

## Accessories included for main oven and cooktop

|                       |   |
|-----------------------|---|
| <b>Oven wire rack</b> | 2 |
|-----------------------|---|

## Electrical Connection

|                        |                |   |                   |
|------------------------|----------------|---|-------------------|
| <b>Plug</b>            | (B) NEMA 5-15P | <b>Type of electric cable installed</b> | Yes, Single phase |
| <b>Current</b>         | 15 A           | <b>Power cord length</b>                | 59 1/16 "         |
| <b>Circuit breaker</b> | 15 A           | <b>Frequency</b>                        | 60 Hz             |
| <b>Voltage</b>         | 120 V          | <b>Terminal block</b>                   | 3 pins            |

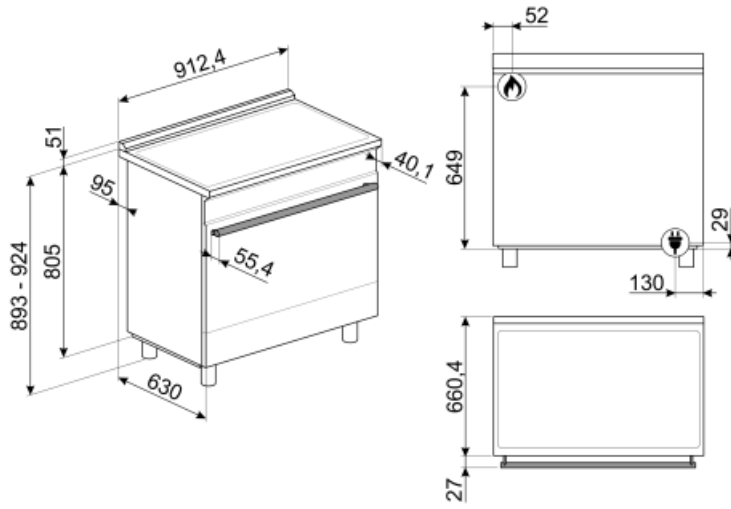

## Not included accessories

### AIRFRY9

Air fryer rack AIRFRY . Ideal for recreating traditional frying in the oven, but with fewer calories and less fat. It allows you to cook quickly and simply dishes such as French fries, fried vegetables and fish, ensuring perfect browning and crispiness.



### SFLK1

Child lock



### GT3T



### PPR9

Refractory pizza stone without handles. Squared stone (HxWxD): 0.9" x 25.2" x 14.75". Also suitable for gas ovens, to be placed on a rack



### BBQ9



### KITTKSPR36

Plinth, 3 sides, 900mm , SPR cookers 30", black



### PRTX

Refractory pizza stone with handles. D=35cm Not suitable for microwave ovens. Suitable for gas ovens, to be put on the griddle.



### WOKGHU

Cast-Iron WOK Support



### GRM

Gas hobs moka support



















### PALPZ

Pizza shovel with fold away handle width: 315mm length : 325mm



## Symbols glossary (TT)

|  |  |
|--|--|
|  <p>Heavy duty cast iron pan stands: for maximum stability and strength.</p>   |  <p>Installation in column: Installation in column</p>  |
|  <p>Knobs control</p>  |  <p>Air cooling system: to ensure a safe surface temperatures.</p>  |
|  <p>Defrost by time: with this function the time of thawing of foods are determined automatically.</p>   |  <p>...</p>   |
|  <p>Triple glazed doors: Number of glazed doors.</p>   |  <p>Enamel interior: The enamel interior of all Smeg ovens have a special antacid lining which helps keep the interior clean by reducing the amount of cooking grease adhering to it.</p>                     |
|  <p>Circogas: In gas ovens the fan distributes the heat quickly and evenly throughout the oven cavity, avoiding flavour transfer when cooking a number of different dishes at the same time. In electric ovens this combination completes cooking more quickly of foods that are ready on the surface, but that require more cooking inside, without further browning.</p> |  <p>Lower heating element only: This function is ideal for foods that require extra base temperature without browning, e.g. pastry dishes, pizza. Also suitable for slow cooking of stews and casseroles.</p> |
|  <p>Grill element: Using of grill gives excellent results when cooking meat of medium and small portions, especially when combined with a rotisserie (where possible). Also ideal for cooking sausages and bacon.</p>  |  <p>Gas ovens offer instantaneous heat control, reduced cooking times and the ability to bake at much lower temperatures than electric ovens.</p>   |
|  <p>The inner door glass: can be removed with a few quick movements for cleaning.</p>  |  <p>Side lights: Two opposing side lights increase visibility inside the oven.</p>  |
|  <p>The oven cavity has 5 different cooking levels.</p>  |  <p>Soft close: all models are equipped with advanced function of smooth closing of the door, which allows the device to close smoothly and quietly.</p>  |

---

## Benefit (TT)

---

### **Gas hob**

Induction offers fast cooking and precise temperature control

Equipped with a thermocouple, the gas supply is cut off if the flame is extinguished for greater safety

### **Touch control**

Easy and intuitive timer setting with a single touch

### **Single turbine**

The oven has a fan equipped with a circular heating element allowing cooking with rotating heat

### **Isothermic Cavity**

The best cooking performance at the highest energy efficiency

### **Tangential cooling**

New cooling system with tangential fan and airflow from the door to the splashback

### **Soft close**

The door is equipped with a specific system for silent closing

### **Multilevel halogen light**

Internal halogen lighting on different levels guarantees excellent visibility

### **Adjustable height**

Cooker top flushed with the working area thanks to adjustable feet

### **Removable inner glass**

Internal door glasses are easily removable for complete cleaning

### **Multilevel cooking**

Several cooking levels allow maximum flexibility of use

### **Cold door**

During any function, the external door glass is cold, avoiding any risk of burns

### **AirFry (AIRFRY optional accessory)**

Lighter and tastier food thanks to airfry basket

### **BBQ (optional accessory)**

Barbeque cooking directly in the oven with the double-sided grill



---

**Pizza stone (optional accessory)**

Baking with refractory stone for soft and crispy pizza and yeast products (STONE optional accessory)