

# SPR36UGMX

Range size	36"
Cooktop type	Gas
Main oven	Thermo-ventilated
EAN code	8017709316587



## Aesthetic



<b>Aesthetics</b>	Mixed	<b>Cooktop color</b>	Black enamel
<b>Series</b>	Professional	<b>Grates</b>	Cast Iron
<b>Color</b>	Stainless steel	<b>Control setting type</b>	Control knobs
<b>Finishing</b>	Satin	<b>Control knobs</b>	Pro-style control knobs
<b>Control panel finish</b>	Stainless steel	<b>Controls color</b>	Stainless steel
<b>Logo</b>	Assembled	<b>Silkscreen color</b>	Black
<b>Logo position</b>	Fascia below the oven	<b>Handle</b>	Robust knurled handle
<b>Upstand</b>	Yes	<b>Handle color</b>	Brushed stainless steel

## Programs / Functions

No. of cooking functions 8

### Traditional cooking functions

Static	Fan-assisted	True European convection
Small grill	Large grill	Large grill + Fan
Convection bottom	Pizza	

### Cleaning functions

VaporClean
------------

### Other functions

 Defrost by time

## Cooktop technical features

### Cooking zones 6

Front-left - 5300 W - 18000 BTU  
 Rear-left - 2900 W - 10000 BTU  
 Front-center - 2900 W - 10000 BTU  
 Rear-center - 2900 W - 10000 BTU  
 Front-right - 5300 W - 18000 BTU  
 Rear-right - 2900 W - 10000 BTU

## Main Oven Technical Features



<b>No. of lights</b>	2	<b>Removable inner door</b>	Yes
<b>Fan number</b>	2	<b>Total no. of door glasses</b>	3
<b>Volume</b>	4.45 cu. ft.	<b>Cooling system</b>	Tangential
<b>Cavity material</b>	EverClean enamel	<b>Bottom heating element - Power</b>	1700 W
<b>No. of shelves</b>	5	<b>Upper heating element - Power</b>	1200 W
<b>Shelves type</b>	Metal racks	<b>Grill power</b>	1700 W
<b>Light type</b>	Halogen	<b>Large grill - Power</b>	2900 W
<b>Light Power</b>	40 W	<b>Circular heating element - Power</b>	2 x 1550 W
<b>Time setting</b>	Minute minder	<b>Grill type</b>	Electric
<b>Removable door</b>	Yes	<b>Soft Close system</b>	Yes
<b>Full-glass inner door</b>	Yes		

## Main oven options

**Minimum Temperature** 149 °F      **Maximum temperature** 500 °F

## Accessories included for main oven and cooktop

**Oven wire rack** 2      **Meat Probe** 1

## Electrical Connection

<b>Plug</b>	(B) NEMA 14-50P	<b>Type of electric cable installed</b>	Yes, Double phase
<b>Electrical connection rating</b>	3800 W	<b>Power cord length</b>	47 1/4 "
<b>Current</b>	16 A	<b>Frequency</b>	60 Hz
<b>Circuit breaker</b>	20 A	<b>Terminal block</b>	3 pins

Voltage

208/240 V

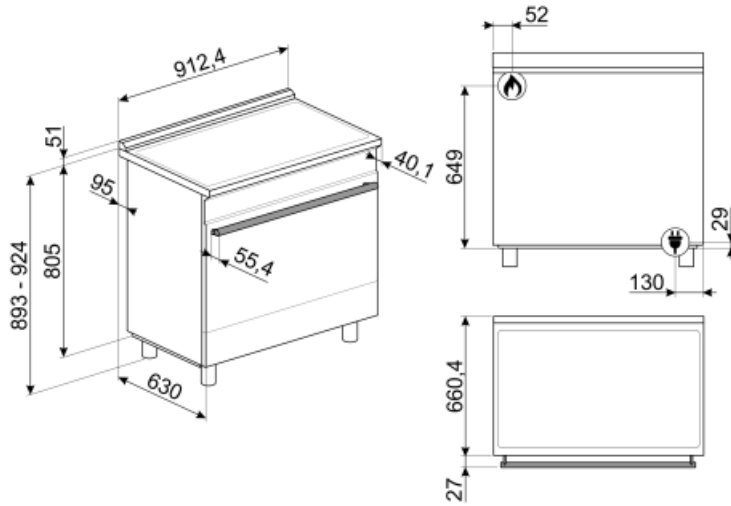

---

## Not included accessories

---

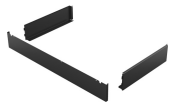

### KITTKSPR36

Plinth, 3 sides, 900mm , SPR cookers 30", black



### SFLK1

Child lock



### GT3T

### GRM



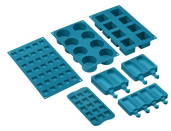

















Gas hobs moka support



### SMOLD

Set of 7 silicone moulds for ice creams, ice lollies, pralines, ice cubes or to portion food. Usable from -60°C to +230°C

## Symbols glossary (TT)

 <p>Heavy duty cast iron pan stands: for maximum stability and strength.</p>	 <p>Installation in column: Installation in column</p>
 <p>Knobs control</p>	 <p>Air cooling system: to ensure a safe surface temperatures.</p>
 <p>Defrost by time: with this function the time of thawing of foods are determined automatically.</p>	 <p>Triple glazed doors: Number of glazed doors.</p>
 <p>Enamel interior: The enamel interior of all Smeg ovens have a special antacid lining which helps keep the interior clean by reducing the amount of cooking grease adhering to it.</p>	 <p>Circogas: In gas ovens the fan distributes the heat quickly and evenly throughout the oven cavity, avoiding flavour transfer when cooking a number of different dishes at the same time. In electric ovens this combination completes cooking more quickly of foods that are ready on the surface, but that require more cooking inside, without further browning.</p>
 <p>Fan with upper and lower elements: The elements combined with the fan aim to provide more uniform heat, a similar method to conventional cooking, so pre-heat is required. Most suitable for items requiring slow cooking methods.</p>	 <p>Upper and lower element only: a traditional cooking method best suited for single items located in the centre of the oven. the top pf the oven will always be hottest. Ideal for roast, fruit cakes, bread etc.</p>
 <p>True European Convection: The combination of the fan and circular heating element around it provides many benefits, including no preheat if cooking time is longer than 20 minutes, no flavor transfer when cooking different foods at the same time, lower energy consumption, and shorter cooking times. Suitable for all types of food preparations.</p>	 <p>Grill element: Using of grill gives excellent results when cooking meat of medium and small portions, especially when combined with a rotisserie (where possible). Also ideal for cooking sausages and bacon.</p>
 <p>Half grill: For rapid cooking and browning of foods. Best results can be obtained by using the top shelf for small items, the lower shelves for larger ones, such as chops or sausages. For half grill heat is generated only at the centre of the element, so is ideal for smaller quantities.</p>	 <p>Fan with grill element: The fan reduces the fierce heat from the grill, providing an excellent method of grilling various foods, chops, steaks, sausages etc. giving even browning and heat distribution, without drying out the food. The top two levels recommended for use, and the lower part of the oven can be used to keep items warm at the same time, an excellent facility when cooking a grilled breakfast. Half grill (centre portion only) is ideal for small quantities of food.</p>
 <p>Pizza function: The simultaneous operation of three elements ensures an optimum cooking facility when used with the Smeg pizza stone.</p>	 <p>Gas ovens offer instantaneous heat control, reduced cooking times and the ability to bake at much lower temperatures than electric ovens.</p>
 <p>All glass inner door: All glass inner door, a single flat surface which is simple to keep clean.</p>	 <p>The inner door glass: can be removed with a few quick movements for cleaning.</p>
 <p>Side lights: Two opposing side lights increase visibility inside the oven.</p>	 <p>The oven cavity has 5 different cooking levels.</p>



Soft close: all models are equipped with advanced function of smooth closing of the door, which allows the device to close smoothly and quietly.



Vapor Clean: a simple cleaning function using steam to loosen deposits in the oven cavity.

## Benefit (TT)

---

### **True-convection**

The best cooking performances guaranteed by ventilated circular flow.

Multiple fans and heating elements guarantee the perfect aerodynamic heat flow, allowing homogeneous and quicker cooking inside the cavity.

### **Gas hob**

Induction offers fast cooking and precise temperature control

Equipped with a thermocouple, the gas supply is cut off if the flame is extinguished for greater safety

### **Touch control**

Easy and intuitive timer setting with a single touch

### **Isothermic Cavity**

The best cooking performance at the highest energy efficiency

### **Double Turbine**

The oven has two fans equipped with two circular heating elements allowing cooking with rotating heat

### **Tangential cooling**

New cooling system with tangential fan and airflow from the door to the splashback

### **Soft close**

The door is equipped with a specific system for silent closing

### **Multilevel halogen light**

Internal halogen lighting on different levels guarantees excellent visibility

### **Adjustable height**

Cooker top flushed with the working area thanks to adjustable feet

### **Removable inner glass**

Internal door glasses are easily removable for complete cleaning

### **Multilevel cooking**

Several cooking levels allow maximum flexibility of use

### **Cold door**

During any function, the external door glass is cold, avoiding any risk of burns

---

**AirFry (AIRFRY optional accessory)**

Lighter and tastier food thanks to airfry basket

**BBQ (optional accessory)**

Barbeque cooking directly in the oven with the double-sided grill

**Pizza stone (optional accessory)**

Baking with refractory stone for soft and crispy pizza and yeast products (STONE optional accessory)