

Table of Contents

1 Description	13
1.1 General Description	13
1.2 Cooktop	13
1.3 Control panel	14
1.4 Other parts	15
1.5 Available accessories	15
2 Use	17
2.1 Instructions	17
2.2 Using the accessories	19
2.3 Using the cooktop	20
2.4 Using the oven	23
2.5 Programming clock	24
2.6 Using the temperature probe	28
2.7 Cooking advice	31
3 Cleaning and maintenance	35
3.1 Instructions	35
3.2 Cleaning the cooktop	36
3.3 Cleaning the door	36
3.4 Cleaning the oven cavity	38
3.5 Steam clean function	39
3.6 Special maintenance	40



WARNING

Never Operate the Top Surface Cooking Section of this Appliance Unattended.

- **Failure to follow this warning statement could result in fire, explosion, or burn hazard that could cause property damage, personal injury, or death.**
- **If a fire should occur, keep away from the appliance and immediately call your fire department.**

DO NOT ATTEMPT TO EXTINGUISH AN OIL/GREASE FIRE WITH WATER.

We advise you to read this manual carefully, which contains all the instructions for maintaining the appliance's aesthetic and functional qualities.

For further information on the product: www.smeg.com



Important Safety Instructions

IMPORTANT SAFETY INSTRUCTIONS

Important Note to the Customer



WARNING

If the instructions contained in this manual are not followed precisely, a fire or explosion may result causing property damage, personal injury or loss of life.

FOR YOUR SAFETY

- Do not store or use gasoline or other flammable vapors, liquids or materials near this or any other appliance.

WHAT TO DO IF YOU SMELL GAS

- Do not try to light any appliance.
- Do not touch any electrical switch.
- Do not use any telephones in your building.
- Immediately call your gas supplier from a neighbor's phone. Follow the gas supplier's instructions.
- If you cannot reach your gas supplier, call the fire department.
- Installation and service must be performed by a qualified installer, service company or gas supplier.



WARNING: Tip Over Hazard

- A child or adult could tip the range over and be killed.
 - Verify the anti-tip device has been properly installed and engaged.
 - Ensure the anti-tip device is re-engaged when the range is moved.
 - Do not operate the range without the anti-tip device in place and engaged.
 - Failure to follow these instructions can result in death or serious burns to children and adults.
- 
- The illustration shows a silhouette of a child pushing a large, dark rectangular object (representing a range) over its side. The object is tilted at a steep angle, and the child is positioned at the base of the object, having just pushed it over. This visualizes the tip-over hazard mentioned in the text.

- Check for proper installation and use of the anti-tip bracket. Carefully tip the range forward by pulling it from the back to ensure that the anti-tip bracket engages the range leg and prevents tip-over. The range should not move more than 1" (2.5cm).



- Read all instructions before using this appliance.
- This manual contains important safety symbols and instructions. Please pay attention to these symbols and follow all instructions given.
- Do not attempt to install or operate your appliance until you have read the safety precautions in this manual. Safety instructions throughout this manual are labeled with a **WARNING** or **CAUTION** statement based on the risk type.
- Warnings and important instructions appearing in this guide are not meant to cover all possible conditions and situations that may occur. Common sense, caution, and care must be exercised with installing, maintaining or operating your appliance.
- Keep these instructions with your owner's guide for future reference.

Definitions

- This manual contains important safety symbols and instructions. Please pay attention to these symbols and follow all instructions given.



WARNING

This symbol will help alert you to situations that may cause serious bodily harm, death or property damage.



CAUTION

This symbol will help alert you to situations that may cause injury or property damage.

Unpacking and installation

- Remove all tape and packaging before using the appliance. Dispose of the packaging after unpacking the appliance. Never allow children to play with packaging material.
- Remove all temporary labels from the oven and cooktop.
- Record the Model and Serial number on Page 2 of this booklet. The Model and Serial numbers are on the Cooker ID plate. The plate is visibly located on the right side of the oven door frame. **THE ID PLATE MUST NOT BE REMOVED.**



Important Safety Instructions

- Do not leave the packing materials around the home. Sort the various items of waste and take them to the nearest specialized waste collection facility.
- Cold temperatures can damage the electronic control. If this appliance has not been used for a long time, make sure that it has been stored at temperatures above 32°F (0°C) for at least 3 hours before turning power on.
- Never modify or alter the construction of the appliance. For example, do not remove leveling legs, panels, wire covers or anti-tip brackets/screws.
- Be sure to have an appropriate foam-type fire extinguisher available, clearly visible and easily accessible located near the appliance.
- All materials used to make cabinets, enclosures, and supports surrounding the product must have a temperature rating of above 200°F (94°C).
- Failure to follow these instructions may result in electrical shock or other personal injury.
- Do not use an adapter.
- Do not use an extension cord.
- For appliances equipped with a cord and plug, do not cut or remove the ground prong. It must be plugged into a matching grounding type receptacle to avoid electrical shock, fire, serious injury, or death. If there is any doubt as to whether the wall receptacle is properly grounded, the customer should have it checked by a qualified electrician.
- Installation must conform with local codes or, in the absence of local codes, with the National Fuel Gas Code, ANSI Z223.1/NFPA 54 or, in Canada, the Natural Gas and Propane Installation Code, CSA B149.1.
- The appliance must be electrically grounded in accordance with local codes or, in the absence of local codes, with the National Electrical Code, NFPA 70 latest edition or, in Canada, the Canadian Electric Code, CSA C22.1-02.

Grounding instructions

- Fire hazard or electrical shock.

Important Safety Instructions



- Install only as per the installation instructions provided in the documentation received with this appliance.
- It is the personal responsibility of the consumer to have the appropriate outlet or junction box with the correct, properly grounded wall receptacle installed by a qualified electrician.
- It is the responsibility and obligation of the consumer to contact a qualified installer to assure that the electrical installation is adequate and is in conformance with all local codes and ordinances.
- See the installation instructions provided with this appliance for complete installation and grounding instructions.
- Do not store explosives, such as aerosol cans, on or near the appliance.
- **DO NOT LEAVE CHILDREN UNATTENDED:** Children should not be left alone or unattended in the area where the appliance is being used. Never allow children to sit or stand on any part of the appliance.



WARNING

Never leave children alone or unattended in the area where an appliance is in use. As children grow, teach them the proper, safe use of all appliances. Never leave the oven door open when the cooker is unattended.



CAUTION

Do not store items of interest to children in cabinets above a cooker or on the backguard of a cooker - children climbing on the cooker to reach items could be seriously injured

Instructions for using the appliance

- Flammable materials should not be stored in the oven, near surface burners or elements, or in the storage or warmer drawer (if provided). This includes paper, plastic, and cloth items, such as cookbooks, plasticware and towels, as well as flammable liquids.



Important Safety Instructions

- Do not allow children to climb or play around the appliance. The weight of a child on an open oven door may cause the appliance to tip, resulting in serious burns or other injury. An open drawer when hot may cause burns.
- Do not attempt to repair or replace any part of this appliance unless specifically recommended in this manual. All other servicing should be done by a qualified technician.



WARNING

- NEVER cover any slots, holes or passages in the oven bottom or cover an entire rack with materials such as aluminum foil. Doing so blocks air flow through the oven and may lead to carbon monoxide poisoning. Aluminum foil linings may also trap heat, causing a fire hazard.
- NEVER use this appliance as a space or room heater. Doing so may result in carbon monoxide poisoning and cause the appliance to overheat.
- In case of fire or a gas leak, turn off the main gas shutoff valve.
- For safety reasons and to avoid damage to your appliance, never sit, stand or lean on the oven door.
- PLACE THE OVEN RACKS IN THE DESIRED POSITION WHILE THE OVEN IS COOL: If a rack must be removed while the oven is hot, do not allow the potholders to come in contact with the broil.
- USE CAUTION WHEN OPENING THE OVEN DOOR: Allow hot air or steam to escape before removing or placing foods in the oven.

Important Safety Instructions



- Do not leave the packing materials around the home. Sort the various items of waste and take them to the nearest specialized waste collection facility.
- Do not obstruct oven vents or openings for air intake.
- **ELECTRICAL GROUNDING IS REQUIRED.** It is the customer's responsibility:
 - To contact a qualified electrician.
 - To ensure that the electrical system is adequate and in compliance with the National Electrical Code ANSI / NFPA 70 Electrical Code – latest edition – Or the CANADIAN ELECTRICAL CODE, C22.11 – 1982 and C22.2 No. 01982 – or latest edition – and all local codes and ordinances.
- Always check that the controls are in the "zero" (off) position when the range is not in use.
- Use only pots or pans with a perfectly smooth, flat bottom on the range surface burners. **NEVER USE THE RANGETOP AS A WORK SURFACE.**
- Do not attempt to repair or replace any part of this appliance unless specifically recommended in this manual. All other servicing should be done by a qualified technician.
- Never use any part of the range or oven for storage. Flammable materials can ignite and plastic items may melt or burst into flame.
- Do not hang articles on any part of the appliance or place anything against the oven. Some fabrics are extremely flammable and could ignite.
- **IMPORTANT:** After a spill or boilover, turn off the burner and clean around it. After cleaning, check that the burner functions properly.
- **WARNING:** **NEVER** cover any slots, holes or passages in the oven bottom or cover an entire rack with materials such as aluminium foil. Doing so blocks air flow through the oven and may cause carbon monoxide poisoning. Aluminium foil linings may also trap heat, causing a fire hazard.



Important Safety Instructions

- Prevent aluminum foil from contacting the heating elements.
- Never leave the range unattended when using high heat settings. Boilover can cause smoke and spattered grease can ignite.
- Not all types of glass, thermally resistant glass-ceramic, ceramic, earthenware, or other glazed cookware are suitable for range use. This type of cookware can break with sudden temperature changes. Use only on low or medium heat settings in accordance with the instructions supplied by the manufacturer.
- **DO NOT HEAT UNOPENED FOOD CONTAINERS:** A buildup of pressure can cause the containers to burst.
- **DO NOT USE FLAMMABLE PRODUCTS TO CLEAN THE RANGE.**
- Do not clean, rub, damage or remove the oven door gasket. It is essential for a good, tight seal during baking and when the self-clean cycle is engaged. Replace the oven door gasket if it becomes damaged or encrusted with food residue.
- **BEFORE BAKING OR BROILING FOR THE FIRST TIME,** turn on the oven and broiler to burn off any dirt, oil or grease remaining from the manufacturing process. Turn the oven on and set to 450°F (230°C) for 20 to 30 minutes.

Cleaning and maintenance instructions

- Be sure all range burner controls are turned off and that the cooktop is cool before using any type of cleaning product. The chemical elements in these products could, in the presence of heat, ignite or cause corrosion of metal parts.
- **DO NOT USE FLAMMABLE PRODUCTS TO CLEAN THE COOKER.**

Important Safety Instructions



- Do not clean, rub, damage or remove the oven door gasket. It is essential for a good, tight seal during baking and when the self-clean cycle is engaged. Replace the oven door gasket if it becomes damaged or encrusted with food residues.
- **ONLY QUALIFIED SERVICE PERSONNEL SHOULD PERFORM REPAIRS.** Service personnel must disconnect the power supply before servicing this unit.
- Unlike the standard gas cooker, **THIS COOKTOP IS NOT REMOVABLE.** Do not attempt to remove the cooktop.
- Do not touch the halogen light bulb directly with your fingers, but wrap it in insulating material.

State of California Proposition 65



WARNING

Cancer or Reproductive Harm -
www.P65Warnings.ca.gov



WARNING

Do not repair, replace or remove any part of the appliance unless specifically recommended in the manuals. Improper installation, service or maintenance can cause injury or property damage. Refer to this manual for guidance. All other servicing should be done by an authorized service provider.

- Make sure that your cooker is properly secured and the anti-tip device is correctly installed. Refer to the instructions in the installation manual.

This appliance has been tested and found to comply with the limits for a class B digital device, pursuant to Part 18 of the FCC rules (United States) and ICES-001 (Canada). These limits are designed to provide reasonable protection against harmful interference in a residential installation. This unit uses and can radiate radio frequency energy that may interfere with radio communications if not installed and used in accordance with the instructions manual.



Important Safety Instructions

However, there is no guarantee that interference will not occur in a particular installation. If this unit does cause interference to radio or television reception, which can be determined by turning the unit off and on, the user is encouraged to try to correct the interference by one or more of the following measures:

- Reorient or relocate the receiving antennas.
- Increase distance between unit and receiver.
- Connect the unit into an outlet or a circuit different from the one to which the receiver is connected.

How to read the user manual

This user manual uses the following reading conventions:

Instructions



General information on this user manual, on safety and final disposal.

Description



Description of the appliance and its accessories.

Use



Information on the use of the appliance and its accessories, cooking advice.

Cleaning and maintenance



Information for proper cleaning and maintenance of the appliance.



Safety instructions



Information



Advice

1. Use instruction sequence.
 - Single use instructions.

SAVE THESE INSTRUCTIONS



1 Description

1.1 General Description

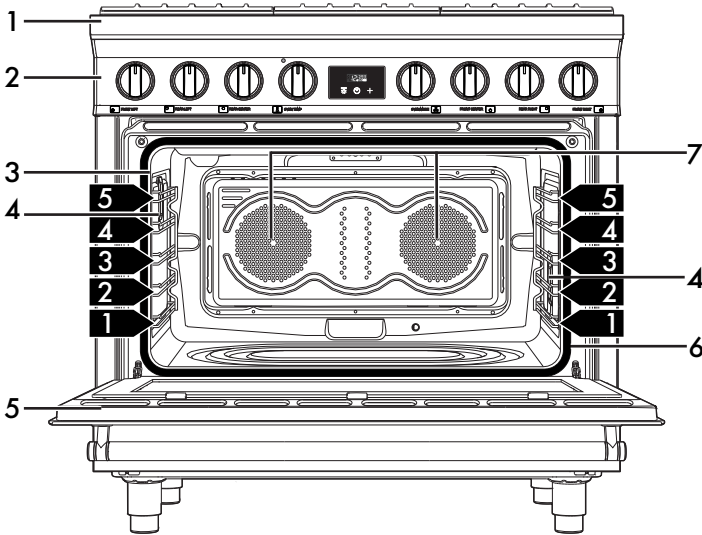

1 Cooktop

5 Door

2 Control panel

6 Seal

3 Temperature probe socket

7 Fan

4 Oven light

1,2,3 Rack/tray support frame shelf

1.2 Cooktop

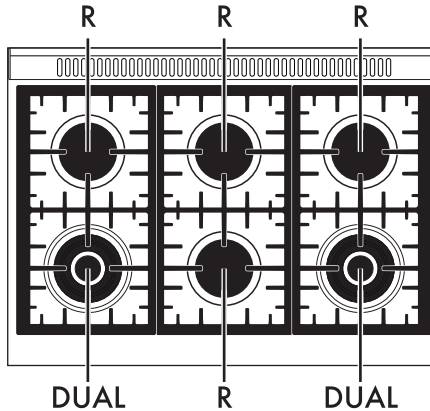

R = Rapid

DUAL = Ultra-rapid



Description

1.3 Control panel

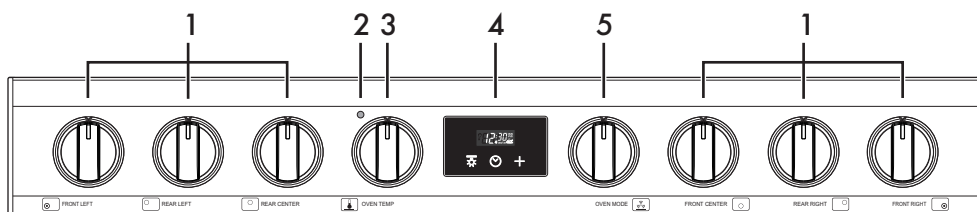

1 Cooktop burner knobs

Used for lighting and adjusting the burners.

The following markings appear on each cooktop knob:

OFF burner OFF position;

burner electric ignition;

MAX burner MAX flame setting;

MIN burner MIN flame setting.

On the DUAL cooktop knob:

burner outer and inner ring flame setting;

burner inner ring flame setting.

2 Hot oven indicator light



CAUTION

High temperature inside the oven.

The indicator light comes on to indicate that the oven is hot. Each time the indicator light comes on, the appliance emits an acoustic signal.

Depending on the set temperature (from 250 to 500°F) it will activate after about 10-12 minutes of operation.

It switches off when the oven cavity has cooled down.



NOTE: In Broil mode, the indicator light remains off. It lights up at the end of the function during the cooling phase to indicate that the oven is still hot.

3 Temperature knob

This knob allows you to select the cooking temperature. Turn the knob clockwise to the required value between the minimum and maximum settings

4 Programmer clock

Useful for displaying the current time, set the minute minder time, set the cooking time, set the timer, and turn the light inside the appliance on/off.

5 Function knob

The oven's various functions are suitable for different cooking modes. After selecting the required function, set the cooking temperature using the temperature knob.



1.4 Other parts

Shelves

The appliance is fitted with shelf supports to position trays and racks at different heights. The insertion heights are indicated from the bottom upwards (see 1.1 General Description).

Oven cavity lighting

The internal lighting of the device is turned on/off only by pressing the decrease value button



Cooling fan

The fan cools the oven and comes into operation during cooking.

The fan causes a steady outflow of air that exits from the rear of the appliance, which may continue for a brief period of time even after the appliance has been turned off.

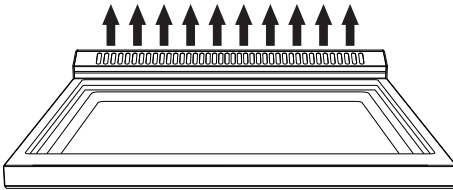

NOTE: Do not obstruct ventilation openings and heat dispersal slots.

1.5 Available accessories

Rack

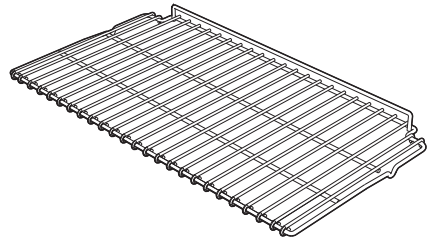

Used to hold containers containing food to be cooked.

Temperature probe



With the temperature probe, you can cook according to the temperature measured at the center of the food.

WOK ring (not included)

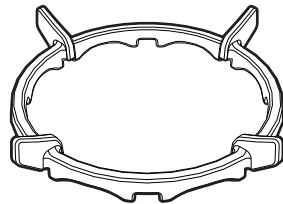

Useful when using a wok.



Description

Protective cover

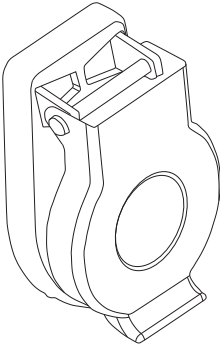

Used to cover and protect the temperature probe socket when the temperature probe is not in use.

i **NOTE:** Some models are not provided with all accessories.

i **NOTE:** The accessories intended to come into contact with food are made of materials that comply with the provisions of current legislation.

i **NOTE:** Supplied and optional can be requested from Authorized Assistance Centers. Use only original accessories supplied by the manufacturer.



2 Use

2.1 Instructions



WARNING

Danger of burns

High temperature inside the oven during use

- Keep the oven door closed when the appliance is in use.
- Protect your hands by wearing oven gloves when moving food inside the oven.
- Do not touch the heating elements inside the oven.
- Do not pour water directly onto very hot trays.
- Keep children under the age of 8 away from the appliance when it is in use.
- If you need to move food or at the end of cooking, open the door 5 cm for a few seconds, let the steam come out, then open it fully.



WARNING

Danger of burns

Improper use

- Make sure that the flame-spreader crowns are correctly positioned in their seats with their respective burner caps.
- Oils and grease could catch fire if overheated. Be very careful.



CAUTION

Risk of damage to surfaces

Improper use

- Do not cover the bottom of the oven cavity with aluminum or tin foil sheets.
- If you wish to use greaseproof paper, place it so that it will not interfere with the hot air circulation inside the oven.
- Do not place pans or trays directly on the bottom of the oven cavity.
- Do not use the open door to rest pans or trays on the internal glass pane.
- Do not pour water directly onto very hot trays.
- Cooking vessels or griddle plates should be placed inside the perimeter of the cooktop.
- All pans must have smooth, flat bottoms.
- If any liquid does boil over or spill, remove the excess from the cooktop.



WARNING

Danger of burns

High temperature inside the storage compartment.

- Do not open the storage compartment when the appliance is on and still hot.
- The items inside the storage compartment could be very hot after using the appliance.



WARNING

Danger of fire or explosion

High temperature inside the oven during use

- Do not spray any products near the appliance.
- Do not use or leave flammable materials near the appliance or the storage compartment.
- Do not use plastic cookware or containers when cooking food.
- Do not put sealed tins or containers in the oven.
- Do not leave the appliance unattended during cooking operations where fats or oils could be released.
- Remove all trays and racks which are not required during cooking.

A gas leak can cause an explosion.

If you smell gas or there are faults in the gas system:

- Immediately turn off the gas supply or close the valve on the gas cylinder.
- Extinguish all naked flames and cigarettes.
- Do not turn on power switches or appliances and do not remove plugs from power sockets. Do not use phones or mobile phones inside the building.
- Open the window in order to ventilate the room.
- Call customer assistance services or your gas supplier.

Malfunctions

Any of the following indicate a malfunction and you should contact a service center.

- Yellowing of the burner plate.
- Damage to kitchen utensils.
- The burners do not ignite properly.
- It is difficult to keep the burners lit.
- The burners go out when the appliance is in use.
- It is difficult to turn the gas valves.

If the appliance does not work properly, contact your local Authorized Assistance Center.

First-time use of the range

1. Remove any protective film from the outside or inside of the appliance, including accessories.
2. Remove any labels (apart from the technical data plate) from the accessories and from the oven cavity.
3. Remove and wash all the appliance accessories (see 3 Cleaning and maintenance).
4. Heat the empty appliance to the maximum temperature to burn off any residues left by the manufacturing process.



2.2 Using the accessories

Racks and trays

Racks and trays have to be inserted into the side guides until they come to a complete stop.

The mechanical safety locks that prevent the rack from being taken out accidentally have to face downwards and towards the oven back.

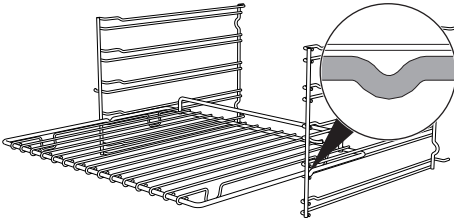

NOTE: Gently insert racks and trays into the oven until they come to a stop.



NOTE: Clean the trays before using them for the first time to remove any residues left by the manufacturing process.

WOK ring (not included)

The WOK ring reducer has to be placed on the cooktop grates. Make sure it is properly placed.

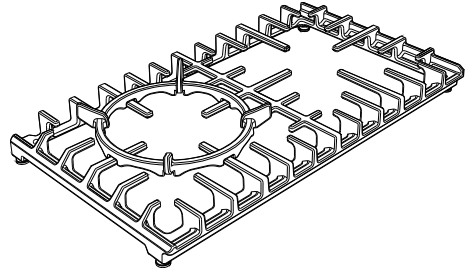

NOTE: For best results, we recommend using the WOK rack only on the Ultra-rapid DUAL burner.



NOTE: If a WOK ring is used on the Ultra-rapid DUAL burner, the right rear Reduced-rapid burner must be left off.



2.3 Using the cooktop



WARNING

Fire Hazard

- For your safety: do not allow the burner flame to extend beyond the edge of the pan.

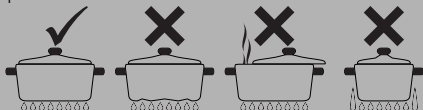

- Turn off all controls when the cooktop is not in use.

All the appliance's control and monitoring devices are located together on the front panel. The burner controlled by each knob is shown next to the knob. The appliance is equipped with an electronic ignition device. Simply press the knob and turn it counter-clockwise to the maximum flame symbol until the burner lights. If the burner does not light in the first 15 seconds, turn the knob to **OFF** and wait 5 minutes before trying again.

After lighting, keep the knob pressed in for a few seconds to allow the thermocouple to heat up. The burner may go out when the knob is released: in this case, the thermocouple has not heated up sufficiently.

Wait a few moments and repeat the operation. Keep the knob pressed in longer.



NOTE: If it is turned off by accident, a safety device will trip, shutting off the gas supply, even if the gas tap is open. Return the knob to **OFF** and wait at least 5 minutes before lighting it again.

To operate the cooktop burners

1. Press and turn the knobs counter-clockwise to the value  to light the relative burners.
2. Turn the knobs to the zone between **MAX** and **MIN** to adjust the flame.
3. Return the knobs to the **OFF** position to turn off the burners.



Setting the DUAL flame size



NOTE: The inner ring will be lit when you light the outer ring on either high or low flame settings. It is not possible to light the outer ring without lighting the inner one.

Refer to the following diagrams:

Outer ring

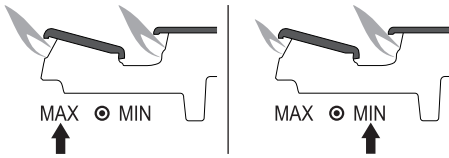

Inner ring

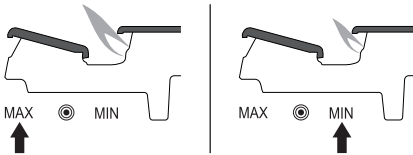

Simmer function



NOTE: This function is extremely useful for melting food like butter, chocolate or similar and for simmering small quantities of food.

1. Switch on the DUAL burner internal cup.
2. Set the flame to the minimum.
3. Leave the external cup off.



NOTE: If the external cup switches on at full power, set half power at least for the internal cup.

Correct positioning of the flame-spreader crowns and burner caps

Before lighting the cooktop burners, make sure that the flame-spreader crowns are correctly positioned in their seats with their respective burner caps. Make sure that the holes **1** of the flame-spreader crowns **2** are aligned with the thermocouples **3** and igniters **4**.

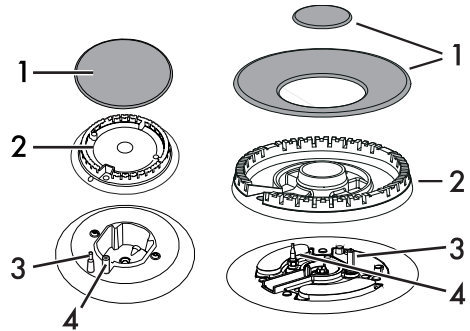

Practical tips for using the cooktop

For better burner efficiency and to minimize gas consumption, use pans with lids and of suitable size for the burner so that the flames do not reach up the sides of the pan. Once the contents come to the boil, turn down the flame far enough to ensure that the liquid does not boil over.

Cookware diameters

Burner	Ø min. - max.	
	inches	cm
R	7 ¹ / ₈ - 9 ⁷ / ₁₆	18 - 24
DUAL	7 ¹ / ₈ - 10 ¹ / ₄	18 - 26



Use

Cookware

Ideally, cookware should have a flat bottom, straight sides, a tight-fitting lid and medium-to-heavy thickness.

Rough cookware finishes may scratch the cooktop. Aluminum and copper may be used in cookware as a core material or for the base. However, when used as a base they can leave permanent marks on the cooktop or grates.

Cookware properties are a factor in how quickly and evenly heat is distributed, which affects cooking results. A non-stick finish has the same characteristics as its base material. For example, a non-stick finish on aluminum cookware will take on the properties of aluminum.

Refer to the following chart as a guide to the physical properties of cookware.

Aluminum

- Heats quickly and evenly.
- Suitable for all types of cooking.
- Medium or heavy thickness is best for most cooking tasks.

Cast iron

- Heats slowly and evenly.
- Good for browning and frying.
- Maintains heat for slow cooking.

Ceramic or glass-ceramic

- Follow the manufacturer's instructions.
- Heats slowly but unevenly.
- Best results with low to medium heat settings.

Copper

- Heats very quickly and evenly.

Earthenware

- Follow the manufacturer's instructions.
- Use low heat settings.

Porcelain enameled steel or cast iron

- See stainless steel or cast iron.

Stainless steel

- Heats quickly but unevenly.
- Stainless steel cookware with an aluminum or copper core or bottom provides even heating.



2.4 Using the oven



WARNING

Fire Hazard

- Keep the oven door closed when the appliance is in use.



NOTE: If there is no power, the cooling fan will not work. Do not try to switch on the oven manually.

To switch on the oven:

1. Select the cooking function using the function knob.
2. Select the temperature using the temperature knob.
3. If you wish, you can set the a timed cooking with the programmer clock. If you avoid using the programmer clock and thus setting a manual cooking you have to stop the oven manually by turning both the temperature and the function knobs to the **OFF** position.

Functions list

BAKE

As the heat comes from above and below at the same time, this system is particularly suitable for certain types of food. Traditional cooking, also known as static cooking, is suitable for cooking just one dish at a time. Perfect for all types of roasts, bread and cakes, and in any case, particularly suitable for fatty meats such as goose and duck.

CONV BOTTOM

The combination of the fan with just the bottom heating element allows cooking to be completed more rapidly. This system is recommended for sterilizing or for finishing off the cooking of foods which are already well-cooked on the surface, but not inside, which therefore need a little more heat. Perfect for any type of food.

BROIL

Using the heat released from the central part of the broil element, this function allows you to grill small portions of meat and fish for making kebabs, toasted sandwiches and any types of grilled vegetable side dishes

BROIL MAX

The heat coming from the whole broil element gives perfect grilling results above all for thin and medium thickness meat and in combination with the rotisserie (where fitted) gives the food an even browning at the end of cooking. This function is perfect for sausages, ribs and ham. This function enables large quantities of food, particularly meat, to be grilled evenly.

CONV BROIL

The airflow produced by the fan softens the strong heatwave generated by the broil element, grilling perfectly even very thick foods. Perfect for large cuts of meat (e.g. shin of pork).



Use

CONV BAKE

The operation of the fan, combined with traditional cooking, ensures consistent cooking even with complex recipes. Perfect for biscuits and cakes, even when simultaneously cooked on several levels. (For multiple-level cooking, we recommend using the 2nd and 4th shelves)

TRUE CONV

The combination of the fan and the circular heating element (incorporated in the rear of the oven) allows you to cook different foods on several levels, as long as they need the same temperatures and same type of cooking. Hot air circulation ensures instant and even distribution of heat. It will be possible, for instance, to cook fish, vegetables and biscuits simultaneously (on different levels) without odours and flavours mingling.

STEAM CLEAN

This function makes cleaning easier using the steam produced by a little quantity of water poured onto the appropriate groove placed on the bottom (see "Steam clean function").

DEFROST (Rapid)



Rapid defrost is assisted by the activation of a fan to ensure uniform distribution of room temperature air inside the oven. This function can be used for any type of food.

PIZZA

The operation of the fan, combined with the broil and the bottom heating element, ensures uniform cooking even with complex recipes. Perfect not just for pizzas, but also for biscuits and cakes

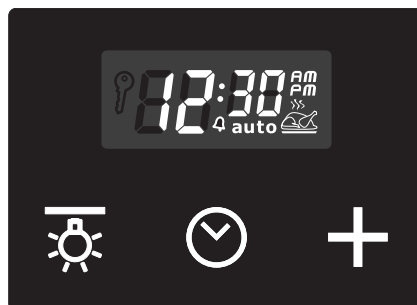
2.5 Programming clock



-  Value decrease key
-  Clock key
-  Value increase key

i Ensure that the programmer clock shows the cooking duration symbol  otherwise it will not be possible to turn on the oven.



Press the key  to reset the programmer clock.







Setting the time

i If the time is not set, the oven will not switch on.

On the first use, or after a power failure, the digits  will be flashing on the appliance's display.

1. Keep the clock key  for two seconds. The dot between the hours and the minutes flashes.
2. The time can be set via the value increase key  and value decrease key . Keep the key pressed in to increase or decrease rapidly.
3. Wait 7 seconds. The dot between the hours and the minutes stops flashing.







The symbol  on the display indicates that the appliance is ready to start cooking.

 To change the time, hold down the value increase key  and value decrease key  at the same time for two seconds, then set the time.

Minute minder timer

i The minute minder timer does not stop the cooking operation but rather informs the user when the set time has run out.

The minute minder timer can be activated at any time.

1. Keep the clock key  pressed for a few seconds. The display shows the figures  and the symbol  flashing between the hours and minutes.
2. Use the value increase  and value decrease  keys to set the number of minutes required.
3. Wait approx. 5 seconds without pressing any key to finish setting the minute minder. The current time and the symbol  appear on the display.
4. A buzzer will sound when the set time is reached.
5. Press the value decrease key  to turn the buzzer off.

i The minute minder timer can be set from 1 minute to a maximum of 23 hours and 59 minutes.



Timed cooking

i Timed cooking is the function which allows a cooking operation to be started and then ended after a specific length of time set by the user.

1. Keep the clock key pressed for a few seconds. The display shows the figures and the symbol flashing between the hours and minutes.

2. Press the clock key again. On the display the digit appear alternating with the digit and the symbol flashing under the minutes.

3. Use the value increase and value decrease keys to set the required minutes of cooking.

4. Select a function and a cooking temperature.

5. Wait approx. 5 seconds without pressing any key in order for the function to activate. The current time and the symbol **auto** will appear on the display.

At the end of cooking the heating elements will be deactivated. On the display, the symbol turns off, the symbol **auto** flashes and the buzzer sounds.

6. To turn the buzzer off, simply press one of the programmer clock keys.

7. Press the clock key to reset the programmer clock.

i It is not possible to set a cooking time of more than 10 hours.

To cancel the set programming press and hold down the value increase and the value decrease keys at the same time and then turn the oven off manually.

12h or 24h format

The default mode is 12h format.



1. Keep the value increase key for a few seconds. The symbols **AM** or **PM** disappear on the display and 24h format is set.

2. Keep the value increase key pressed for a few seconds to go back to the 12h format.



Selecting the buzzer

The buzzer can have 3 tones.



1. Hold down the value increase  and value decrease  keys at the same time.

2. Press the clock key . The digit  appears on the display.

3. Press the value decrease key  to select a different buzzer tone ( or ).

2.6 Using the temperature probe



High temperature of the temperature probe
Danger of burns

- Do not touch the rod or the tip of the probe after having used it.
- Wear oven gloves when handling the temperature probe.



Improper use
Risk of damage to surfaces

- Take care not to scratch or damage enamelled or chrome-plated surfaces with the tip or the plug of the temperature probe.



Improper use
Risk of damage to the appliance

- Do not insert the probe into openings and slots on the appliance.
- When the probe is not in use, make sure that the protective cover is properly closed.



Improper use
Risk of injury

- Do not leave the temperature probe unattended.
- Do not allow children to play with the probe.
- Take care not to injure yourself on the sharp parts of the probe.



Use



Improper use

Risk of damage to temperature probe

- Do not pull the cable to remove the probe from the socket or from the food.
- Make sure that the probe or its cable do not get caught in the door.
- No part of the probe should be allowed to come into contact with the walls of the oven cavity, the heating elements, the racks or the trays when they are still hot.
- When not in use, the probe should not be kept inside the appliance.
- Make sure the plug of the probe is fully inserted into the socket.
- Do not use the probe to place food into or to remove it from the oven cavity.

With the temperature probe, roasts, pork loin and various cuts and sizes of meat can be cooked to perfection.

The probe, in fact, allows foods to be cooked to perfection because it accurately monitors the core temperature of the food.

The core temperature of the food is measured by a sensor located in the tip of the probe.

Positioning the probe

1. Place the food on a tray.
2. Insert the tip of the probe into the food before placing it in the oven.
3. For best results, make sure that the temperature probe is placed transversely in the thickest part of the food and for least 3/4 of its length. Make sure that it does not touch the tray underneath and that it does not protrude from the food.

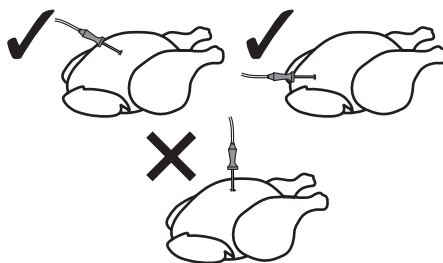

i In order for the probe to measure the core temperature of the food precisely, its tip must not be in contact with bones or fat.

i The minimum recommended oven temperature when cooking using the probe is 250°F, unless slow cooking is used (see Chap. 2.7).



Cooking using the temperature probe

With preheating:

1. Set manual cooking (see "Using the oven").
2. After preheating, open the door and insert the tray onto which the food has been placed into the appropriate guides.
3. Insert the plug of the probe into the socket at the side, using the probe to open the cover.



High temperature inside the oven during use
Danger of burns

- Wear oven gloves when handling the temperature probe.

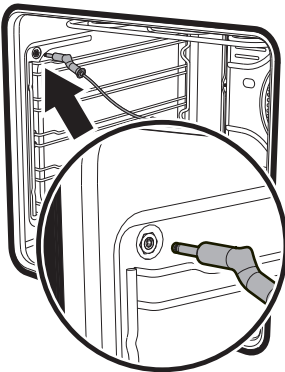

4. Close the door.
5. Press the button for a few seconds; Press the button again. The default target temperature (176°F) is indicated on the display and the **A** symbol flashes.
6. Use the and buttons to regulate the target temperature to a value between the minimum and a maximum.



- **Minimum target temperature:** corresponds to the instantaneous temperature measured by the probe plus 2°C (35°F).
- **Maximum target temperature:** 99°C (210°F)

7. Wait for a few seconds and then press the button to display the instantaneous temperature measured by the probe.
Cooking will now continue until the instantaneous temperature measured by the probe is the same as the target temperature set by the user.



Without preheating:



1. Open the door.
2. Put the tray, on which the food has been placed with the probe in position, into the oven.
3. Insert the plug of the probe into the socket at the side, using the probe to open the cover.
4. Set the cooking using the probe as indicated in steps 5, 6 and 7 in the previous section.
5. Set manual cooking by selecting the temperature and cooking function (see "Using the oven").





When cooking with the temperature probe is in progress



When the temperature probe is used, it is not possible to set programmed cooking or timed cooking.



When cooking with the temperature probe is in progress, the  and  buttons are disabled.

1. Press and hold the  button to activate the minute minder timer; press  again to display the target temperature and use the  and  buttons to adjust it while cooking is in progress.
2. Press  again or wait 5 seconds to return to cooking mode.

At the end of cooking

When the set target temperature for the temperature probe is reached, the heating elements are switched off and the appliance emits a series of beeps.

1. Press a button on the programmer clock to stop the buzzer.
2. Open the door.
3. Remove the probe from the food and unplug it from the socket.
4. Remove the food from the oven.
5. Make sure that the protective cover is properly closed.

2.7 Cooking advice

General advice

- Use pans/trays with a maximum width of 33-35 cm.
- It is not possible to shorten cooking times by increasing the temperature (the food could be overcooked on the outside and undercooked on the inside).
- It is recommended to preheat the oven before baking.
- Using several ovens at the same time might affect the final cooking results.

Advice for cooking meat

- Cooking times vary according to the thickness and quality of the food and to consumer taste.
- Turn the food to brown both sides.
- Use a meat thermometer when roasting meat, or simply press on the roast with a spoon. If it is hard, it is ready; if not, it needs another few minutes cooking.



Advice for cooking with the Broiler

- Meat can be grilled even when it is put into a cold oven or into a preheated oven if you wish to change the effect of the cooking.
- When using the Broil function, preheat the oven for 15 minutes before cooking. Cooking times may vary depending on the thickness of the food.
- We recommend placing the food at the center of the rack.
- Foods should be seasoned before cooking. Foods should also be coated with oil or melted butter before cooking.
- Use the oven tray on the first bottom shelf to collect fluids produced by grilling.

Advice for cooking desserts and biscuits

- Temperature and cooking time depend on the quality and consistency of the dough.
- To check whether the dessert is cooked right through, at the end of the cooking time, put a toothpick into the highest point of the dessert. If the batter does not stick to the toothpick, the dessert is done.
- If the dessert collapses when it comes out of the oven, on the next occasion reduce the set temperature by about 50°F, selecting a longer cooking time if necessary.
- While cooking desserts or vegetables, excessive condensation may form on the glass. In order to avoid this, open the door very carefully a couple of times while cooking.

Tips for cooking on two shelves:

- Use a fan-assisted function to achieve uniform cooking at several levels. Use shelves 2 and 4.
- It is recommended to use 2 racks (can be requested from Authorized Assistance Centers).
- To facilitate the flow of air, place the molds/pans in the center of the racks and make sure that their width/diameter does not exceed 30 cm.
- Position the racks keeping an empty level between them.
- Depending on the food and the increased load in the oven, cooking on two levels may take a few minutes longer than on a single shelf.
- The functions indicated for cooking on two shelves are THERMO-FAN-ASSISTED and THERMO-FAN-ASSISTED BASE.

Advice for defrosting and proving

- Place frozen foods without their packaging in a lidless container on the first shelf of the oven.
- Avoid overlapping the food.
- To defrost meat, use a rack placed on the second level and a tray on the first level. In this way, the liquid from the defrosting food drains away from the food.
- The tenderest parts of the food can be protected with aluminum foil.
- For successful rising, a container of water should be placed at the bottom of the oven.



To save energy

- Unless otherwise indicated on the packaging, defrost frozen food before placing it in the oven.
- In case of multiple cooking, it is advisable to cook the products one after the other to make the most of the already hot oven.
- Use preferably dark metal molds: they help to absorb the heat better.
- Remove all trays and racks which are not required during cooking.
- Stop cooking a few minutes before the time normally used. Cooking will continue for the remaining minutes with the heat that has accumulated inside the oven.
- Reduce any opening of the door to a minimum to avoid heat dispersal.
- Keep the inside of the appliance clean at all times.

Slow cooking with the probe

- This cooking mode is recommended for tender and lean meat whose core temperature should not exceed 65°C (149°F). Set the temperature of the oven to between 90° (194°F) and 100°C (212°F). This increases the cooking time, but maintains the quality of the food and prevents an excessive reduction in its volume.
- For a better result, before slow cooking, brown the meat in a pan over high heat for 1 or 2 minutes on each side.



Cooking information table

Preh = preheating

Runner = position from the bottom

Food	Weight (Kg)	Runner	Function	Preh	Temperature (°F)	Time (minutes)
MEAT						
Roast chicken	1.2	2 - 3	CONV BAKE	Yes	450	65 - 70
Roast loin*	1.5	2 - 3	CONV BAKE	Yes	430	65 - 75

* in a pan on a rack.

DESSERTS						
White cake ¹	1.0	3	BAKE	Yes	350	28 - 30
Biscuits ²	n.9 55 g each.	2	BAKE CONV BAKE	Yes	450	10 - 13
Sugar cookies ²	n.9 15 g each.	2	CONV BAKE	Yes	350	7 - 8
Apple pie ³	1.7 1.1 apple 0.6 dough	3	BAKE	Yes	350 - 375	55 - 65
Cupcakes ⁴	n.12 50 g each.	3	BAKE	Yes	350 - 370	25 - 30

¹ in cake mold Ø 26 cm.

³ in cake mold Ø 23/25 cm.

² flat tray 33 cm wide on rack.

⁴ in muffin mold on oven rack.

GRILLS							1 st side	2 nd side
Hamburger*	n.4 140 g each. thickness 1 cm	5	BROIL	15'	-	9	6	
Sausages* cut and open in half	n.6 180 g each.	4	BROIL	15'	-	15	9	

* food on rack with container underneath.

VEGETABLES						
Roast potatoes*	0.7	2 - 3	CONV BAKE	Yes	450	45 - 50

* in aluminum tray 28 x 30.

FRESH DOUGHS						
Pizza*	0.5 - 0.6	2	CONV BAKE	Yes	MAX	11 - 14

* in baking tray with low edge Ø 28/30 cm.

FRESH FISH						
Bream*	0.6	2 - 3	CONV BAKE	Yes	400	25 - 30

* in a pan on a rack.

The times indicated in the table do not include preheating times and are provided as a guide only.



Use

Temperature probe-cooking information table

Type and cut of meat	Target temperature (°C)	Target temperature (°F)
Beef		
Roast beef: rare	50 - 53	122 - 127
Roast beef: medium	55 - 58	131 - 136
Roast beef: well done	65 - 70	149 - 158
Rib of beef: rare*	50	122
Rib of beef: medium*	58	136
Rib of beef: well done*	70	158
Pork		
Roast loin	80 - 85	176 - 185
Shoulder	80 - 85	176 - 185
Sausages**	75 - 80	167 - 176
Veal		
Veal roast	75 - 80	167 - 176
Poultry		
Whole chicken	80 - 85	176 - 185
Whole turkey	80 - 85	176 - 185
Roast turkey (whole or breast)	80 - 85	176 - 185
Lamb		
Leg of lamb with bone (rare)	65	149
Leg of lamb with bone (well done)	75 - 80	167 - 176
Slow cooking		
Beef / roast beef: rare***	50 - 54	122 - 129
Beef / roast beef: medium***	55 - 60	131 - 140
* Cooking times vary according to the thickness of the fillet.		
** For sausages, it is recommended to select a suitable function to ensure they are well grilled externally.		
*** It is recommended to brown the meat on each side in a pan for a few minutes before putting it in the oven.		



3 Cleaning and maintenance

3.1 Instructions



WARNING

Electrical Shock Hazard

- Before servicing, disconnect the appliance from the power supply.



WARNING

Risk of damage to surfaces

Improper use

- Do not use steam jets to clean the appliance.
- Do not use cleaning products containing chlorine, ammonia or bleach on steel parts or parts with metallic finishes on the surface (e.g. anodizing, nickel- or chromium-plating).
- Do not use abrasive or corrosive detergents on glass parts (e.g. powder products, stain removers and metallic sponges).
- Do not use rough or abrasive materials or sharp metal scrapers.
- Do not wash the removable components such as the cooktop stand support, flame spreaders and burner caps in a dishwasher.
- Keep cooktop area clear and free from combustible materials, gasoline other flammable vapors and liquids.
- Do not obstruct the flow of combustion and ventilation air.

Recommendations



NOTE: We recommend the use of cleaning products distributed by the manufacturer.

To keep the surfaces in good condition, they should be cleaned regularly after use. Let them cool first.

Regular daily cleaning

Always use only specific products that do not contain abrasives or chlorine-based acids.

Pour the product onto a damp cloth and wipe the surface, rinse thoroughly and dry with a soft cloth or a microfiber cloth.

Food stains or residues

Do not use metallic sponges or sharp scrapers as they will damage the surfaces.

Use ordinary non-abrasive products with the aid of wooden or plastic utensils if necessary. Rinse thoroughly and dry with a soft cloth or a microfiber cloth.

Do not allow residues of sugary foods (such as jam) to set inside the oven. If allowed to set for too long, sugar residue could pit the enamel lining of the oven.

Cooktop grates

Remove the grates and clean them with lukewarm water and non-abrasive detergent. Take care to remove any encrustations. Dry thoroughly and place them back on the cooktop.



Cleaning and Maintenance

3.2 Cleaning the cooktop

1. Pour some non-abrasive detergent on a damp cloth and wipe the surfaces.
2. Rinse thoroughly.
3. Dry with a soft cloth or a microfiber cloth.

Cleaning cooktop grates, flame-spreader crowns and burner caps

1. Remove the components from the hob.
2. Clean with lukewarm water and non-abrasive detergent. Take care to remove any encrustations.
3. Dry thoroughly with a soft cloth or a microfiber cloth.
4. Replace the components on the cooktop.

- Remove any dry residue with a toothpick or needle.

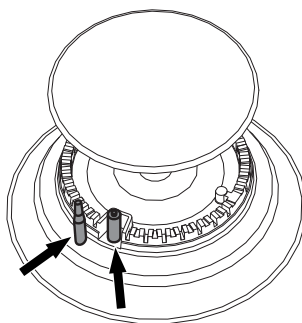

3.3 Cleaning the door

Removing the oven door

To facilitate cleaning, we recommend that you remove the door and place it on a towel.

To remove the door, proceed as follows:

1. Open the door completely and insert two pins into the holes in the hinges, as shown in the image.

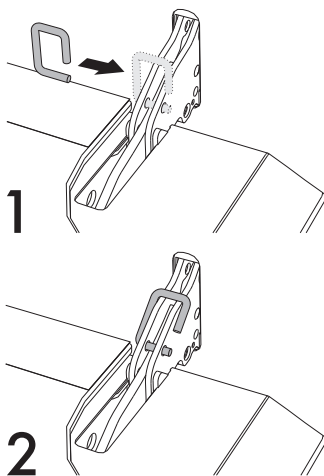

i **NOTE:** Continuous contact between the grates and the flame can lead to the enamel becoming modified on the parts exposed to heat. This is normal and has no effect on the operation of this component.

Cleaning the igniters and thermocouples

- If necessary, clean the igniters and thermocouples with a damp cloth.



2. Grasp the door on both sides with both hands, lift it forming an angle of around 30° and remove it.

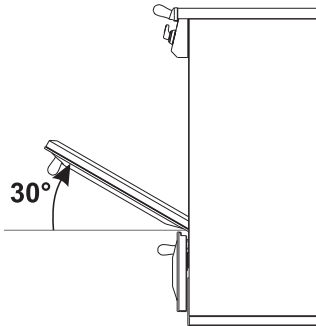

3. To reassemble the door, put the hinges in the relevant slots in the oven, making sure that the grooved sections **A** are resting completely in the slots. Lower the door and once it is in place remove the pins from the holes in the hinges.

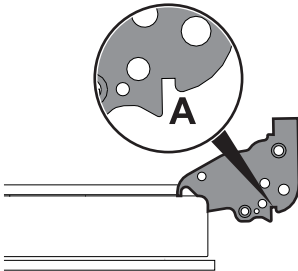

Cleaning the oven door glass

The oven door glass should always be kept thoroughly clean. Use absorbent kitchen roll. In case of stubborn dirt, wash with a damp sponge and an ordinary detergent.

Removing the internal glass panes

To facilitate cleaning, the internal glass panes of the door can be removed.

1. Pull the rear part of the internal glass pane gently upwards, following the movement indicated by the arrows (**1**).

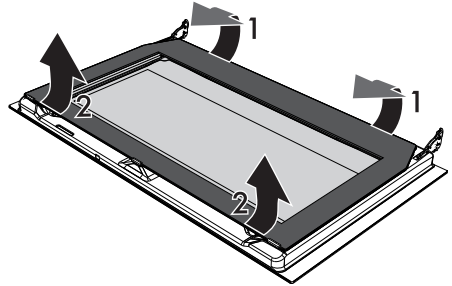

2. Extract the internal glass pane from the front strip (**2**) to remove it from the door.
3. Remove the intermediate glass pane by lifting it upwards.

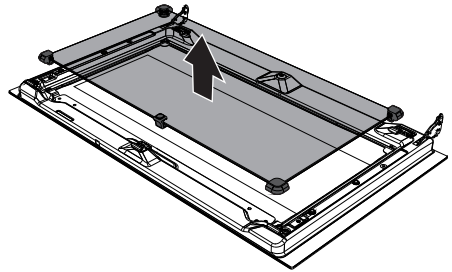

4. Clean the external glass pane and the panes that were previously removed. Use absorbent kitchen roll. In case of



Cleaning and Maintenance

stubborn dirt, wash with a damp sponge and neutral detergent.

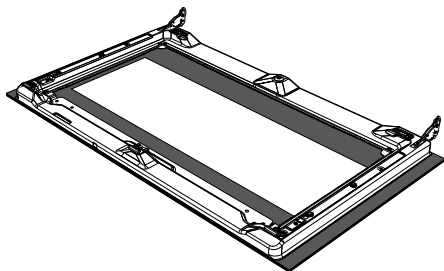

5. When you have finished cleaning, put back the intermediate glass pane into its housing in the door.

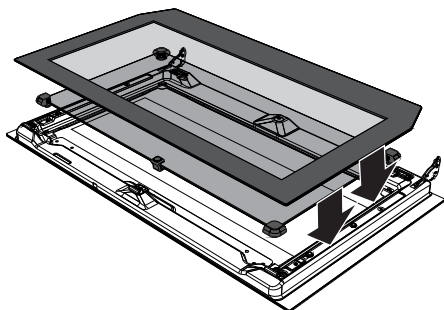

6. To put back the internal glass pane, slide the upper part into the door strip and insert the two rear pins into their seats by pressing lightly.

3.4 Cleaning the oven cavity

In order to keep your oven in the best possible condition, clean it regularly after letting it cool down.

Avoid letting food residue dry inside the oven cavity, as this could damage the enamel.

Take out all removable parts before cleaning.

For easier cleaning, we recommend removing:

- the door;
- the rack/tray supports;
- removable guides, where fitted;
- the seal.



NOTE: If you use specific cleaning products, we recommend running the oven at maximum temperature for 15-20 minutes in order to eliminate any residues.



Removal of the rack/tray supports

Removing the guide frames makes it easier to clean the sides of the oven. This must be done each time you use the automatic cleaning cycle (only on some models).

To remove the guide frames:

- Pull the frame towards the inside of the oven (1) to unhook it from its housing A, and then slide it out of the grooves (2) at the back B.

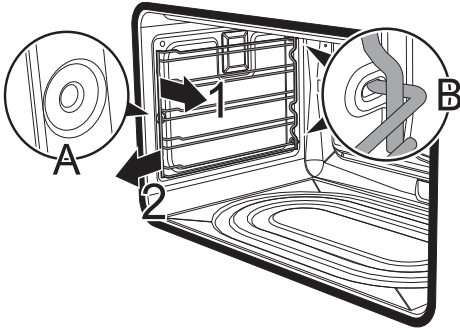

- When you have finished cleaning the oven, repeat the procedures indicated above in reverse to replace the guide frames.

3.5 Steam clean function



CAUTION

Improper use

Risk of damaging the surfaces

- Remove any food residues or large spills from previous cooking operations from the inside of the oven.
- Carry out steam assisted oven cleaning operations only when the oven is cold.

Preliminary operations

Before starting the Steam clean function:

1. Completely remove all accessories from inside the oven. The upper guard can be left inside the oven.
2. Pour approximately 13.5 fl. oz. (400 cc - 1.7 cup) of water onto the bottom of the oven. Make sure it does not overflow out of the cavity.

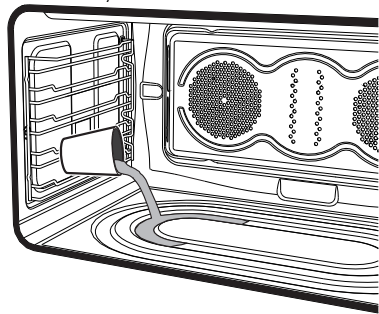

3. Spray a water and washing up liquid solution inside the oven using a spray nozzle. Direct the spray towards the side walls, upwards, downwards and towards the deflector.



We recommend spraying approx. 20 times at the most.

4. Close the door.



Cleaning and Maintenance

Steam clean settings

1. Turn the function knob to the **STEAM CLEAN** position and the temperature knob to 150°F (65°C).
2. Set a cooking time of 45 minutes using the programmer clock.
3. At the end of the cooking time, the timer will switch the oven heating elements off and the buzzer will start to sound.

End of the Steam clean function

1. Open the door and wipe away the less stubborn dirt with a damp cloth.
2. Use a non-scratch sponge with brass filaments to remove hard deposits.
3. In case of grease residues use specific oven cleaning products.
4. Remove the water left inside the oven.

For improved hygiene and to avoid food being affected by any unpleasant odours, we recommend that the oven is dried using a convection function at 300°F for approximately 10 minutes.

3.6 Special maintenance

Seal maintenance tips

The seal should be soft and elastic.

- To clean the seal, use a non-abrasive sponge and wash with lukewarm water.

Replacing the internal light bulb



WARNING

Danger of electrocution

- Unplug the appliance.
- Use protective gloves.



NOTE: The oven is fitted with one 40W light bulb.

1. Completely remove all accessories from inside the oven.
2. Remove the rack/tray supports.
3. Use a tool (e.g. a spoon) to remove the bulb cover.

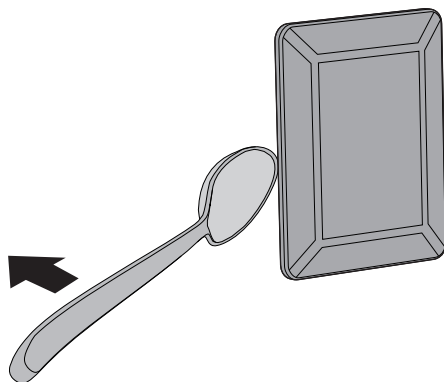

NOTE: Pay attention not to scratch the oven cavity enamel.



4. Loosen and remove the light bulb.

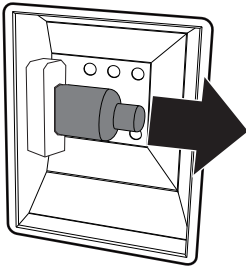

Do not touch the halogen bulb with your fingers; cover it with an insulating cloth.

5. Replace the bulb with a similar one (40 W).
6. Reattach the cover. Leave the inside of the glass molding (A) facing the door.

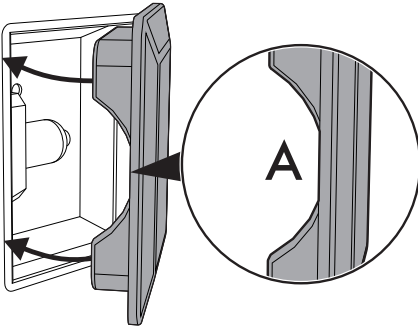

7. Press the cover firmly so that it adheres tightly to the light bulb holder.

Lubricating the surface burner gas valves

Over time, the surface burner gas valves may become stiff or jam. Clean them internally and re-lubricate. This operation must be carried out by a qualified technician.

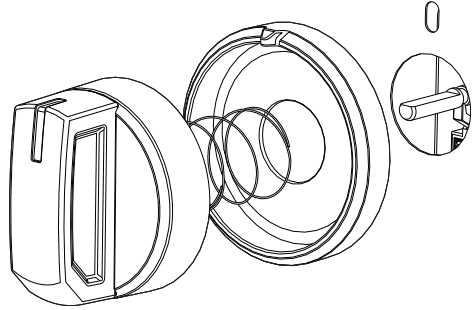

NE

PAGE INTENTIONALLY LEFT BLANK