

SAPPHIRE

Adapting to Your Environment

Indoor, Outdoor and ADA

Wine Refrigerators | Ice Machines | Beverage Centers | Glass Door Refrigerators | Accessories

15" Clear Ice Machine Operator's Manual

Gourmet (SIIM15) & Square Cube Models (SSIM15)
With and Without Factory Installed Drain Pump
Indoor, ADA Height & Outdoor Models



WARNING

California Proposition 65

Certain components in this product and its related accessories contain chemicals known to the state of California to cause cancer, birth defects or other reproductive harm.

PRODUCT REGISTRATION INFORMATION

Please record your model's information. You will need to know this information whenever you call to request information or service. The model's information appears on a serial number plate.

Model Number: _____

Serial Number: _____

You can register your appliance at:

SapphireAppliances.com

Or

Fill out the provided Warranty Registration Card and mail in.

Congratulations on your new SAPPHIRE Ice Machine. To ensure proper operation, please read this Operator's Manual carefully before using this product. Keep this manual in a safe place for future reference.

TABLE OF CONTENTS

SAFETY	5
SAFETY DEFINITIONS.....	5
SAFETY PRECAUTIONS	5
SPECIFICATIONS	7
SAPPHIRE 15-INCH CLEAR ICE SHOT GLASS.....	7
SAPPHIRE 15-INCH SLAB CLEAR ICE	7
INSTALLING THE UNIT	8
REQUIRED CABINET OPENING	10
BUILT-IN CABINET DIMENSIONS	10
SAPPHIRE 15-Inch Indoor Built-In Cabinet Dimensions	10
SAPPHIRE 15-Inch (ADA Height Compliant) Built-In Cabinet Dimensions	11
ELECTRICAL CONNECTION.....	12
AVOIDING USE OF EXTENSION CORDS.....	13
GRAVITY DRAIN MODELS	13
DRAIN PUMP MODELS.....	13
CONNECTING THE WATER SUPPLY	13
LEVELING THE UNIT.....	14
REVERSING THE DOOR	15
CUSTOM DOOR PANEL.....	17
15-Inch Indoor Solid Integrated Panel	18
15-Inch Indoor Framed Integrated Panel.....	19
15-Inch (ADA Height Compliant) Integrated Door Panel	20
Installing the Custom Door Panel	20

ANTI-TIP SYSTEM	22
INTEGRATED GRILL/PLINTH.....	22
OPERATING THE UNIT.....	23
Important: Ensuring Ice Freshness and Quality.....	23
OTHER OPERATING TIPS.....	23
Ice Machine Production	23
USING THE CONTROLS	24
Turning the Unit On.....	25
Turning the Unit Off.....	25
Enter the display of Menu items	26
Running the Clean Ice Machine Cycle.....	29
Setting Quiet Mode 4 Hours	31
Exiting or Stopping Quiet Mode 4 Hours	32
Setting Schedule Quiet Mode	33
Adjusting Ice Thickness	41
Enter Sabbath Mode.....	44
Exiting or Cancelling Sabbath Mode.....	45
Exiting the Menu	46
Clean Alert indicated.....	47
Filter Alert Indicated	48
Clearing Simple Error Codes	49
Error Codes That Require Contacting Customer Service.....	49
EXPECTING NORMAL SOUNDS	52
DEALING WITH POWER FAILURE	52
CARE AND MAINTENANCE.....	53
REPLACING WATER FILTER - INDOOR ICE MACHINES.....	53

CLEANING AND MAINTAINING THE UNIT55

- Cleaning the Unit's Exterior55
- Cleaning the Unit's Interior.....56
- Extended Periods of Non-Use56
- Recommissioning the Unit56
- Starting Up the Unit57
- Cleaning the Condenser57

TROUBLESHOOTING58

DISPOSING THE UNIT60

WARRANTY.....61

1

SAFETY

SAFETY DEFINITIONS

The words DANGER, WARNING, CAUTION and NOTICE are used throughout this manual to highlight important information. Be certain that the meanings of these alerts are known to all who operate and install the appliance.

DANGER

Indicates a hazardous situation that, if not avoided, *will* result in death or serious injury.

WARNING

Indicates a hazardous situation that, if not avoided, *could* result in death or serious injury.

CAUTION

Indicates a hazardous situation that, if not avoided, *could* result in minor or moderate injury.

NOTICE

Indicates a situation that can cause damage to the appliance and/or the environment, or cause the appliance to operate improperly.

SAFETY PRECAUTIONS

POWER CORD PRECAUTIONS

- Do not use the appliance if the power cord is damaged. If the power cord is damaged, have a qualified electrician replace the power cord.
- Never lift, carry or drag the appliance by the power cord.
- Do not connect or disconnect the electric plug when your hands are wet.
- Never unplug the appliance by pulling on the power cord. Always grip the plug firmly and pull straight out from the outlet.

MOVING PRECAUTIONS

- When moving the appliance, do not turn it upside-down and do not unlevel it more than 45 degrees.
- Do not move the appliance without emptying it and securing the door in the closed position.

INSTALLING PRECAUTION

- Connect to potable water supply only.

OTHER PRECAUTIONS

- To ensure proper ventilation for the appliance, keep obstructions away from the front of the unit.
- Keep fingers out of the “pinch point” areas. Clearance between the door and cabinet are necessarily small. Be careful closing the door when children are in the area.
- Do not touch the evaporator with your hand when the appliance is operating.
- Do not attempt to repair or replace any part of your appliance unless this manual specifically recommends it. Have a qualified technician perform all other service on the unit.
- Children 8 years of age and older and people with reduced physical, sensory or mental capabilities or lack of experience and knowledge can use this appliance if they have been given supervision or instruction concerning use of the appliance in a safe way and they understand the hazards involved.
- Never allow children to operate, play with or crawl inside the appliance.
- Never allow children to clean and maintain the machine without supervision.
- Do not use the appliance other than for its intended purpose.
- Do not touch the condenser surfaces. They are sharp and can be easily damaged.

CLEANING AND MAINTENANCE PRECAUTIONS

- Never clean the appliance parts with flammable fluids. Do not store or use gasoline or other flammable vapors and liquids in the vicinity of this appliance or any other appliances. The fumes can create a fire hazard or explosion.
- Do not use solvent-based cleaning agents or abrasives on the interior. These cleaners may transmit taste to the ice cubes, or damage or discolor the interior.
- If the appliance will not be used for a long time, thoroughly clean it before the next use. Carefully follow any instructions provided for cleaning or the use of sanitizing solution. Do not leave any solution inside the appliance after cleaning.

THE MANUFACTURER DISCLAIMS ANY RESPONSIBILITY IF THE ABOVE INSTRUCTIONS ARE NOT FOLLOWED.

2

SPECIFICATIONS

SAPPHIRE 15-INCH CLEAR ICE SHOT GLASS

FEATURES	15-INCH INDOOR GOURMET CUBE ICE MACHINE	15-INCH OUTDOOR GOURMET CUBE ICE MACHINE
Electrical Requirement	115V/60Hz	
Maximum Amp Fuse	15 amp	
Power Consumption	10.5 kWh/100 lb (45.4 kg)	12.4 kWh/100 lb (45.4 kg)
Dispense Type	Water Spray	
Ice Making/Harvesting Rated Current	2.4/2.4 amps	
Ice Quantity per Cycle	24	
Ice Production Capacity at 70°F (21°C)	68 lb (31 kg) per Day	63 lb (28.5 kg) per Day
Ice Storage	25 lb (11 kg)	

SAPPHIRE 15-INCH SLAB CLEAR ICE

FEATURES	15-INCH INDOOR SQUARE CUBE ICE MACHINE WITH PUMP	15-INCH ADA INDOOR SQUARE CUBE ICE MACHINE WITH PUMP
Electrical Requirement	115V/60Hz	
Maximum Amp Fuse	15 amp	
Power Consumption	9.93 kWh/100 lb (45.4 kg)	
Dispense Type	Water Flow	
Ice Making/Harvesting Rated Current	1.9/1.4 amps	
Ice Quantity per Cycle	40	
Ice Production Capacity at 70°F (21°C)	75 lb (34 kg) per Day	
Ice Storage	25 lb (11 kg)	

3

INSTALLING THE UNIT

WARNING

Fire/Explosion Hazard

DO NOT install in spaces containing gasoline engines, fuel tanks or fuel line fittings. This device does not meet federal requirement for ignition protection.

IMPORTANT:

Plumbing and Electrical Tips

- A licensed plumber must install this appliance.
- This appliance must be installed with all electrical and water connections in accordance with state and local codes.
- This unit requires a standard electrical supply properly grounded in accordance with National Electrical Code and local codes and ordinances.
- The fuse (or circuit breaker) size should be 15 amperes for 115V.
- The manufacturer recommends that you provide a separate circuit that services only your appliance. Use receptacles that cannot be turned off by a switch or pull chain.
- Plug the appliance into a grounded three-prong outlet. Do not remove the grounding prong, do not use an adapter, and do not use an extension cord.
- Do not kink, pinch or damage the power supply cord between the ice machine and wall or cabinet.
- Before connecting the ice machine to the power source, let it stand upright for approximately 4 hours. Following this step will reduce the possibility of a malfunction in the cooling system brought on by handling during transportation.
- Make sure to install on level surface and ensure drain line and waterline are not kinked.

Tips on Moving and Setting up the Unit

CAUTION

Tip Hazard

Be sure to use caution when working around an uninstalled unit. The unit is capable of tipping over if it is not installed and properly anchored.

- Use two or more people to move and install the appliance. Failure to do so can result in back or other injury.
- Remove the packing materials and clean the appliance before using it.

Factors Affecting the Unit

- Install this unit in an area protected from the elements (for example, wind, rain, water spray or drips).

NOTE: Do not use an ice machine intended for indoor use outside. Only use an ice machine that is intended for outdoor use outdoors.

- The ambient operational temperature should be between 50°F (10°C) and 100°F (38°C). The input water temperature should be between 41°F (5°C) and 90°F (32°C). Operating the machine outside these temperatures may result in lowered production or other adverse effects.
- Never keep the appliance next to ovens, grills or other high-heat resources.
- Keep the appliance on a hard, level surface that can support the unit when the unit is full. Keep the ice machine level to help ensure it works properly. Keeping an ice machine on an unlevel surface may cause water to flow improperly through the evaporator (ice mold) and will reduce ice production. You may need to make several adjustments to level the unit. If necessary, adjust the height of the ice machine by turning the feet. See “Leveling the Unit” on page 13.
- To ensure proper service access and ventilation, all Sapphire units should not have the grill openings covered. There are no additional requirements for venting at the top, side or rear of the unit.
- These units are to be installed under a counter. Follow the recommended spacing dimensions listed in this manual. Place all electrical and water supplies and drain fixtures in the recommended locations.

Water Supply Tips

- The ice machine requires a continuous water supply with a minimum pressure of 15 psi (0.1 MPa) and a static pressure not to exceed 80 psi (0.5 MPa).
- The manufacturer recommends filtering the water. A water filter helps remove taste, odors, and particles. Using softened water may result in white, mushy cubes that stick together. Avoid using deionized water.
- Ensure that the water supply hose is not pinched, kinked or damaged during installation.
- Check for leaks after connecting the water line.

REQUIRED CABINET OPENING

⚠ WARNING

Fire/Explosion Hazard

DO NOT install in spaces containing gasoline engines, fuel tanks or fuel line fittings. This device does not meet federal requirement for ignition protection. Failure to comply could result in injury or death.

A built-in installation will allow you to install the ice machine under a counter or in a kitchen cabinet if you respect the required clearance space around the clear ice machine. The appliance must be located to allow clearance for water, drain and electrical connections in the rear of the unit.

BUILT-IN CABINET DIMENSIONS

A built-in installation requires for a water line and plug clearance for proper operation. A built-in unit is designed for zero clearance at the top and each side of the unit. The unit uses fan-forced condenser cooling, which requires air circulation through the lower section of the unit.

NOTE: To ensure proper service access and ventilation, all SAPPHIRE units should not have the grill openings covered. There are no additional requirements for venting at the top, side or rear of the unit.

SAPPHIRE 15-INCH INDOOR BUILT-IN CABINET DIMENSIONS

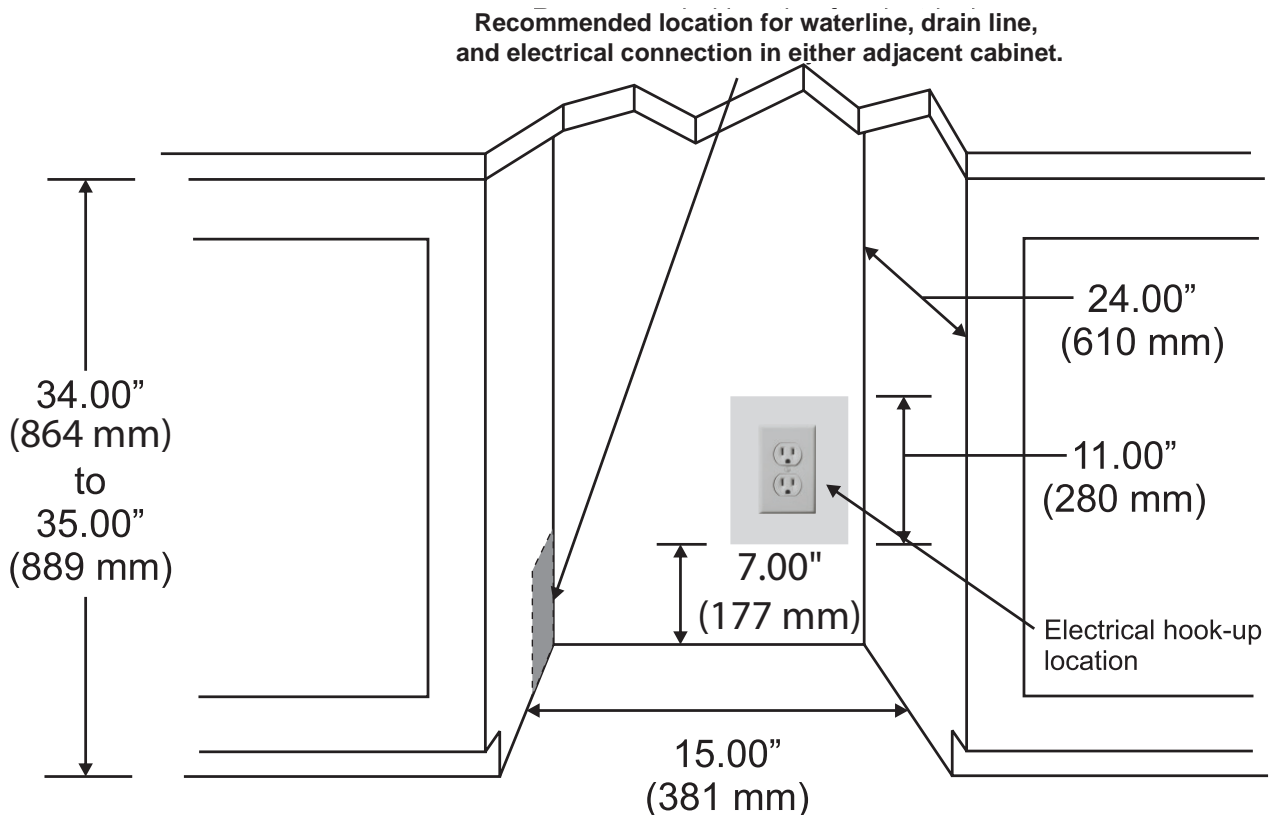

SAPPHIRE 15-INCH (ADA HEIGHT COMPLIANT) BUILT-IN CABINET DIMENSIONS

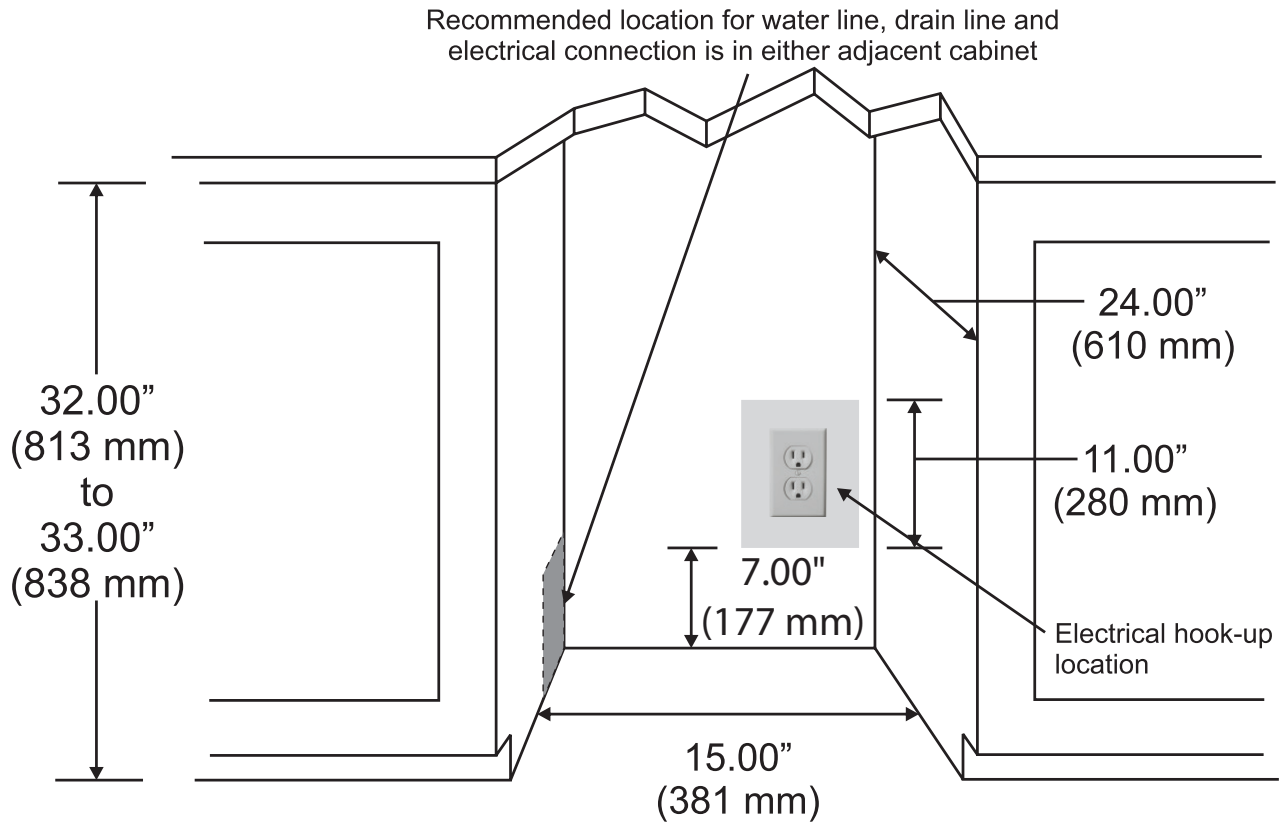

NOTICE

- If you remove the rubber feet from the bottom of the unit, reinstall the mounting screws into the bottom of the cabinet to avoid damage to components mounted to the base pan.
- Ensure that the air path for the grill remains unrestricted. Any restriction of airflow through the grill will disrupt normal operation of the unit, resulting in damage to components, and voids warranty.
- Connect the unit to a potable water supply only.
- The minimum distance the unit needs to be installed when adjacent to a wall is 7.5 in. (190 mm) is required to obtain full swing (135°) of the door and 2.75 in. (70 mm) when using the 90° pin (provided) to restrict the swing of the door. The two distance can make sure the handle does not hit the wall.

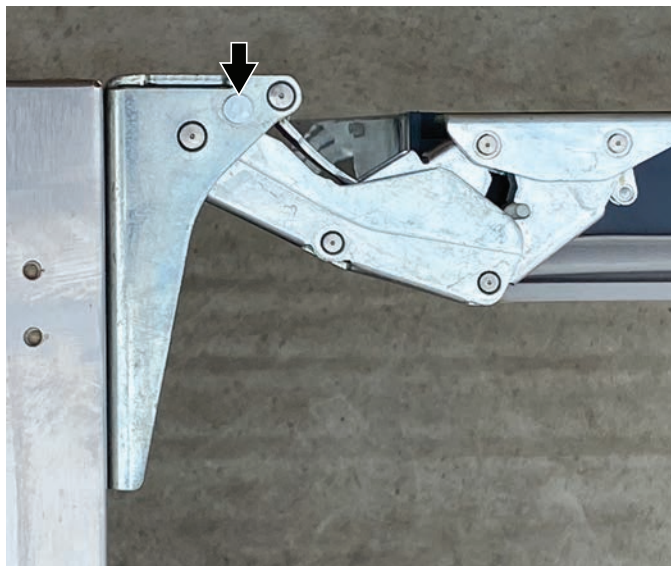

ELECTRICAL CONNECTION

Do not, under any circumstances, cut or remove the third (ground) prong from the power cord.

For personal safety, you must properly ground this appliance. The power cord of this appliance features a three-prong grounding plug that mates with a standard three-prong grounding wall outlet to minimize the possibility of electric shock hazard from the appliance. Have a qualified electrician check the wall outlet and circuit to make sure the outlet is properly grounded. It is your responsibility and obligation to have a standard two-prong wall outlet replaced with a properly grounded three-prong wall outlet.

Always plug the appliance into its own individual electrical outlet. The voltage rating of the outlet must match the rating label on the appliance. This match provides the best performance and also prevents overloading the electrical circuits, which could cause a fire hazard from overheated wires.

Never unplug your appliance by pulling on the power cord. Always grip the plug firmly and pull straight out from the outlet.

Repair or replace immediately all power cords that have become frayed or damaged. Do not use a cord that shows cracks or abrasion damage along its length or at either end.

When moving the appliance, take care not to damage the power cord.

If the supply cord suffers damage, have the manufacturer, its service agent, or similarly qualified persons replace the supply cord to avoid a hazard.

AVOIDING USE OF EXTENSION CORDS

Because of potential safety hazards under certain conditions, the manufacturer strongly recommends that you do not use an extension cord with this appliance.

GRAVITY DRAIN MODELS

- The drain hose must have a minimum drop of 1/4" per foot and must not create traps.
- Insulate the drain hose to prevent condensation.

DRAIN PUMP MODELS

WARNING

Electrical Shock Hazard

Be sure the floor surfaces surrounding the appliance are dry before plugging in and removing the power cord to the outlet to prevent electrical shock.

Follow these steps to test the operation of the drain pump before final installation:

1. Check the power cord and make sure it is not plugged into the outlet.
2. Place the drain hose into a suitable container that can hold at least one gallon.
3. Pour one gallon of water into the ice storage bin.
4. Plug the power cord into a properly grounded, polarized electrical outlet.
5. The drain pump should start and pump the water into the container.
6. Unplug the power cord.

CONNECTING THE WATER SUPPLY

1. Turn off the main water supply. Turn on the nearest faucet long enough to clear a line of water.
2. Find a 1/2" to 3/4" vertical cold-water pipe near the installation location. The distance should be less than 9 feet.
3. Install a shut-off valve to the main water supply. If the water pipe has a plain piece of copper tubing, attach a 1/4" O.D. compression union to the tubing and remove the nut.
4. Thread the nuts of the supplied water supply hose to the tap and water inlet valve. Access to the water inlet valve is through the opening in the rear panel. Tighten firmly by hand, then one-half turn with a wrench.



5. Turn on the main water supply and tap. Check for leaks in the water supply connection. Tighten all connections.

LEVELING THE UNIT

The appliance requires leveling before it can work properly. If necessary, raise or lower the unit by turning the four leveling feet on the bottom. The manufacturer recommends using a carpenter's level to check the appliance.

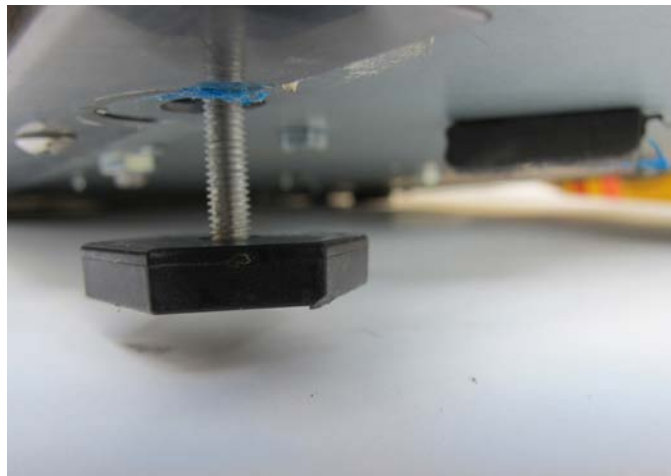

NOTICE

It is extremely important that the ice machine is level. If it is not level, production of uneven ice will occur.

Adjust all four leveling feet evenly so that the top of the appliance is at the desired installation height and is level.

1. On a level surface, place a carpenter's level on top of the appliance to see if it is level from front to back and side to side.
2. Adjust the height of the leveling feet as follows:
 - Turn the leveling feet to the right to lower that side of the appliance.
 - Turn the leveling feet to the left to raise that side of the appliance.

REVERSING THE DOOR

This appliance has the capability of the door opening from either the left or right side. The appliance is delivered to you with the door opening from the left side. Follow these instructions should you desire to reverse the opening direction:

1. Check the power cord and make sure it is not plugged into the outlet.
2. Carefully remove the two plugs at the top and bottom of the left side of the appliance. Save the plugs.



3. Loosen but do not remove the outer top and bottom screws on the right-side hinge.



4. Remove the inner top and bottom right-side hinge screws. Install these screws about three turns in the left-side outer top and bottom screw locations.



5. Lift the door off the partially loosened right-side screws. Rotate the door and position it on the two partially installed left-side screws.
6. Finish removing the outer top and bottom screws from the right-side hinges. Install these screws in the open holes in the left-side hinge location. Tighten all screws.



7. Install the plugs into the four open holes on the right side.

CUSTOM DOOR PANEL

A custom door panel/frame can be fabricated for the appliance. Handle hardware must also be provided, if needed.

Finish all sides of the custom panel. They may be visible when the door is open.

15-INCH INDOOR SOLID INTEGRATED PANEL

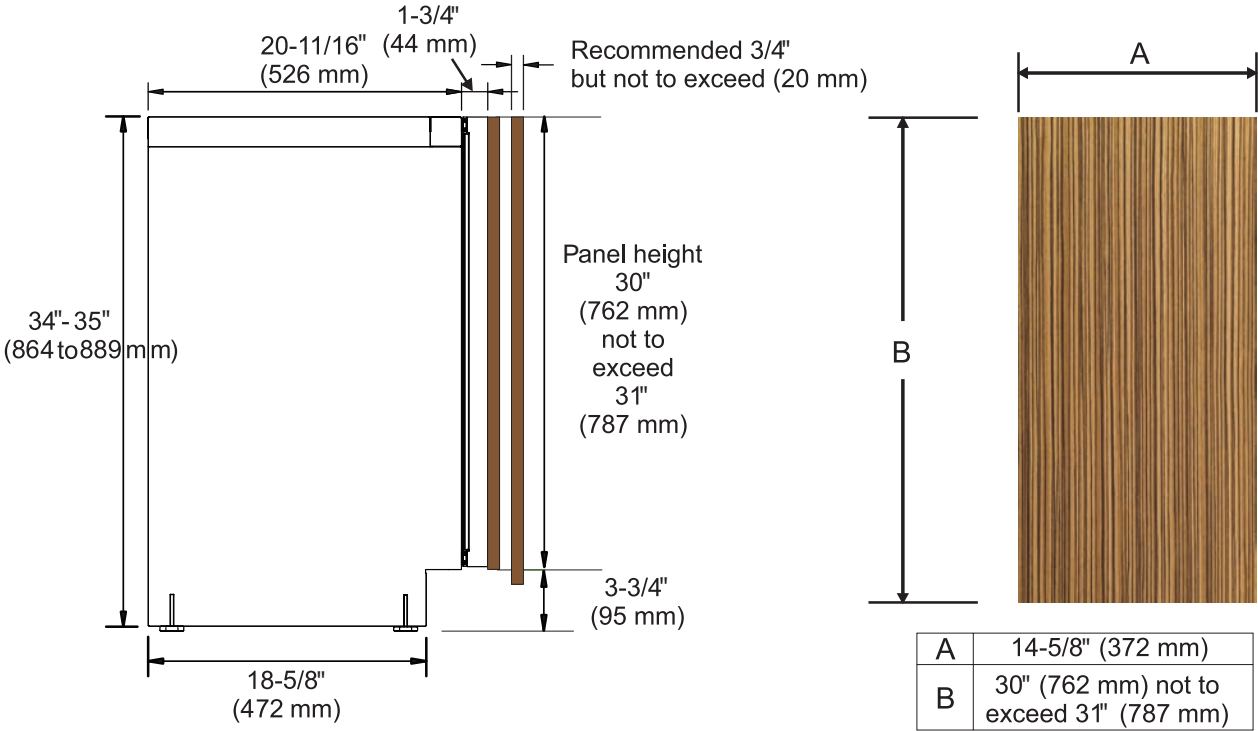

15-INCH INDOOR FRAMED INTEGRATED PANEL

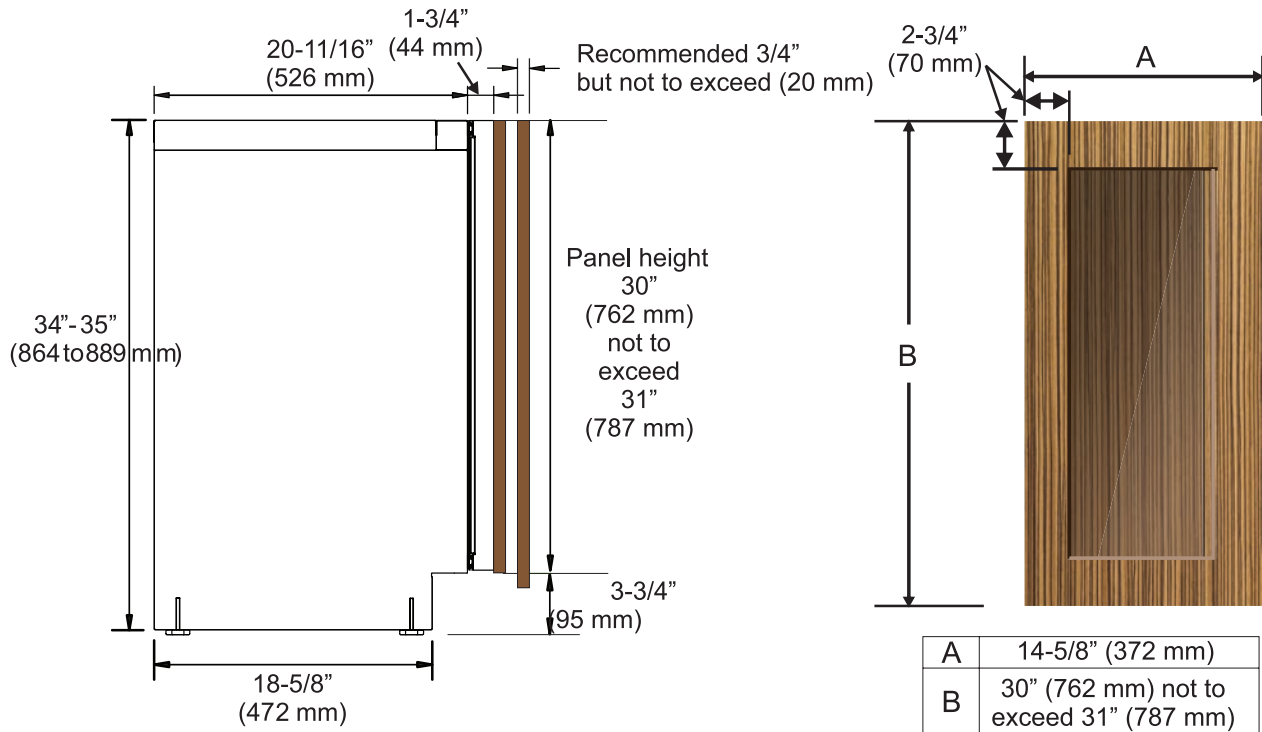

15-INCH (ADA HEIGHT COMPLIANT) INTEGRATED DOOR PANEL

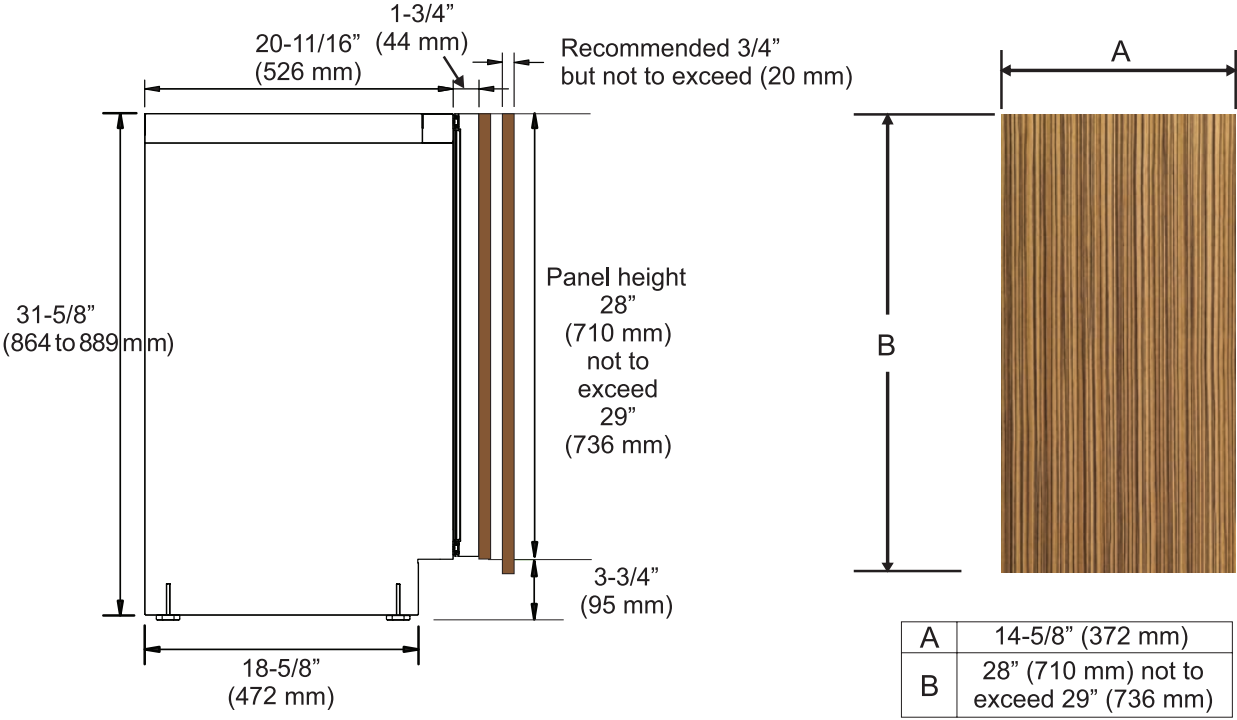

INSTALLING THE CUSTOM DOOR PANEL

- 1. Remove the door from the unit.
- 2. Remove the door seal to gain access to the custom door panel mounting holes.



3. Align the top of the custom door panel flush with the top of the door.
4. Adjust the overlap of the custom door panel so it is equal on both sides of the door.
5. Secure the custom door panel to the door using six wood screws (provided).

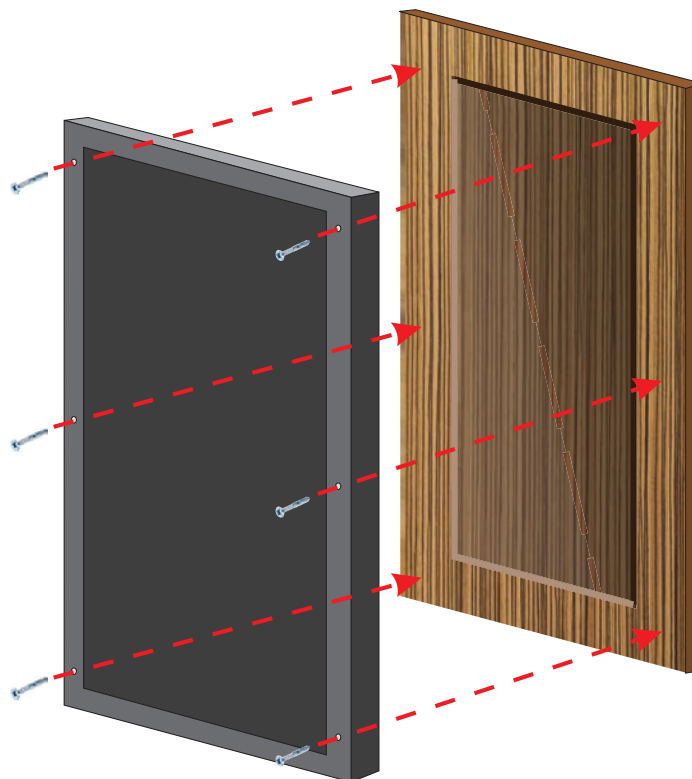
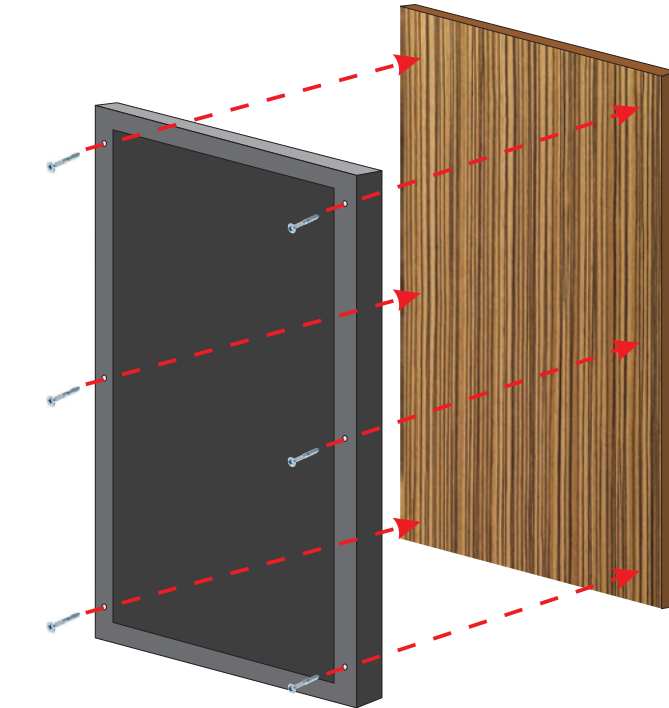

6. Reinstall the door seal. Be sure the seal is properly seated.
7. Reinstall the door to the unit.

ANTI-TIP SYSTEM

On built-in installations, once the appliance is in place and leveled, it is required to secure the two anti-tip brackets underneath the countertop using two screws (provided).

If the brackets for the anti-tip system cannot be secured above the appliance, no wood is available, the brackets for the anti-tip system can be relocated to the side of the appliance for securing into an adjacent cabinet.

INTEGRATED GRILL/PLINTH

An integrated grill/plinth can be fabricated if desired. The thickness of the panel should be between $\frac{1}{4}$ in. to $\frac{3}{8}$ in. (6 mm to 9 mm) and the height will vary between $\frac{3}{16}$ in. to $\frac{5}{16}$ in. (84 mm to 110 mm) depending on you grill grille/plinth height.

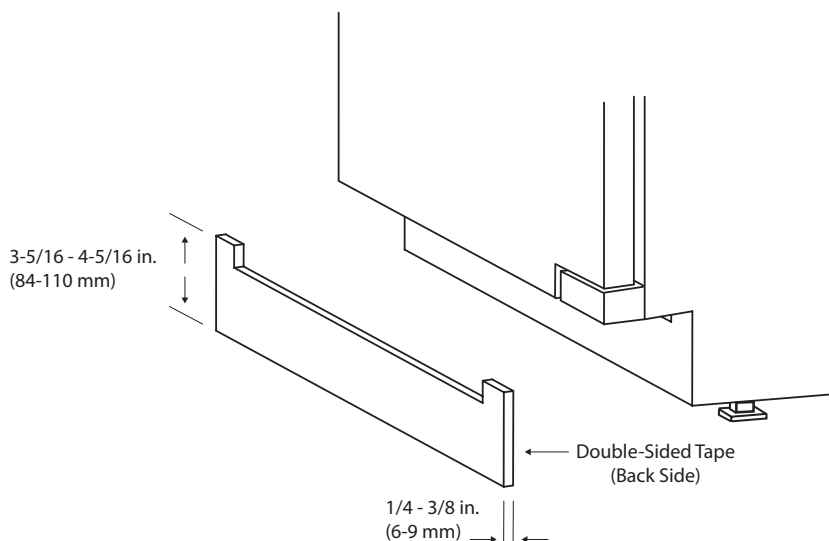

NOTE: When finishing the grill/plinth, be sure to stain front, back and all edges to prevent warping.

Apply double-sided tape to the surrounding edges of the integrated grill/plinth as shown in figure.

Remove the backing paper from the double-sided or hook and looptape. Carefully align the grill/plinth over the integrated grill/plinth and press into position.

4

OPERATING THE UNIT

IMPORTANT: ENSURING ICE FRESHNESS AND QUALITY

- Although the unit has been tested and cleaned at the factory, discard the first batch of ice cubes due to long-term transit and storage.
- If you do not use the ice machine regularly, the manufacturer recommends emptying the ice bin periodically to ensure ice freshness.
- The ice machine produces ice in layers resulting in a clear cube. The ice may appear wet when first produced. Ice in the bin may develop surface frost which appears when the cube is placed in liquid.

OTHER OPERATING TIPS

- Keep the air intake and exhaust free of dust and lint to allow free airflow.
- Clean the ice machine when “clean ice machine” message appears on the control panel. In areas with hard water, cleaning may have to be more frequent.
- Never touch the evaporator when the unit is running.
- Keep the door closed to reduce ice melting and to promote proper ice formation. Open the door only when taking ice from the appliance.
- Turn on the water supply tap before switching on the ice machine. Never turn the water supply tap off when the ice machine is working.

ICE MACHINE PRODUCTION

Individual cube ice machine - the ice machine will continue to produce ice until the ice in the bin contacts the level indicator in the bin. Once the ice level drops below the level indicator, the ice machine will begin producing ice.

Slab ice machine - The ice machine will continue to produce ice until ice in the bin reaches the discharge for the slab ice; not allowing the harvested ice to enter the bin. Once the ice level drops in the bin, the ice machine will continue to produce ice.

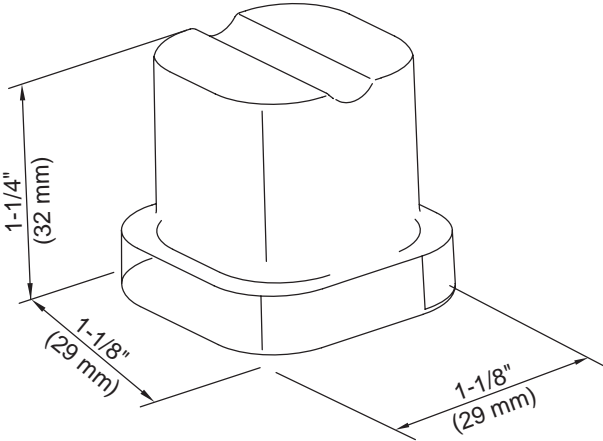

Individual Ice

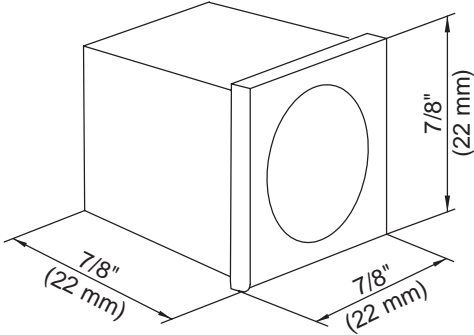

Slab Ice

USING THE CONTROLS

The control panel is located at the top of the appliance.

NOTE: You have 30 seconds to make a control change before the display reverts to the default screen.

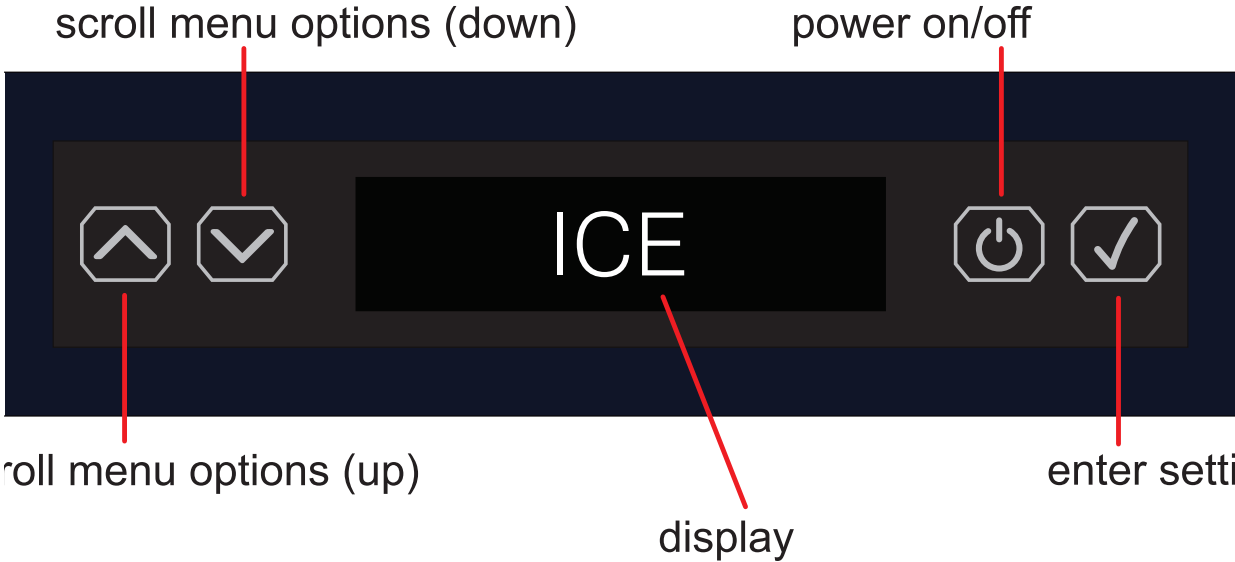

TURNING THE UNIT ON

1. Press the ON/OFF button (🔌).

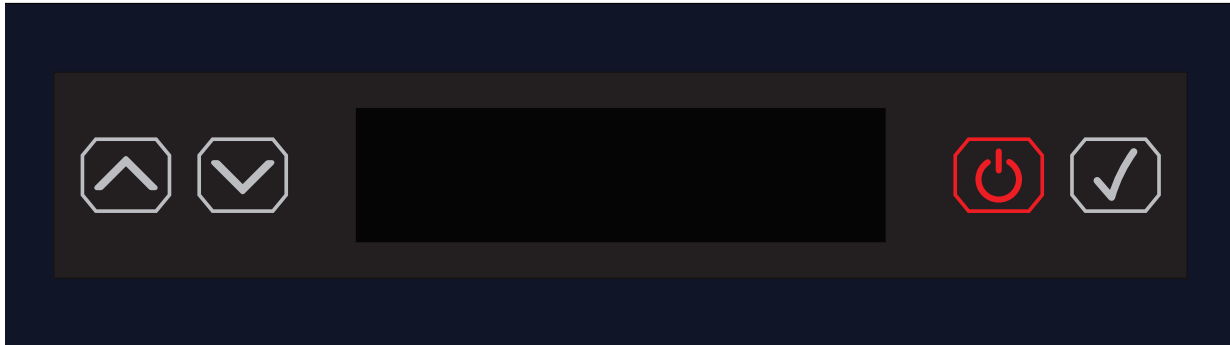

2. The ice machine powers up and displays ICE.

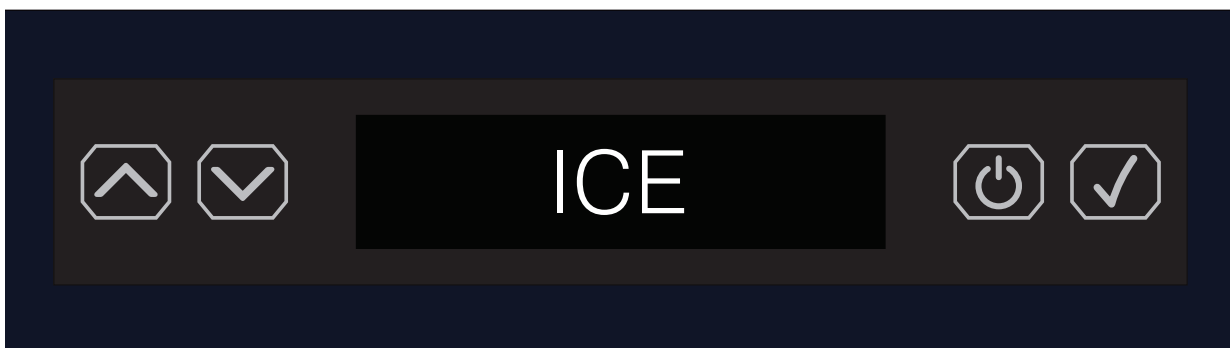

TURNING THE UNIT OFF

1. Press the ON/OFF button (🔌) and hold for 3 seconds.

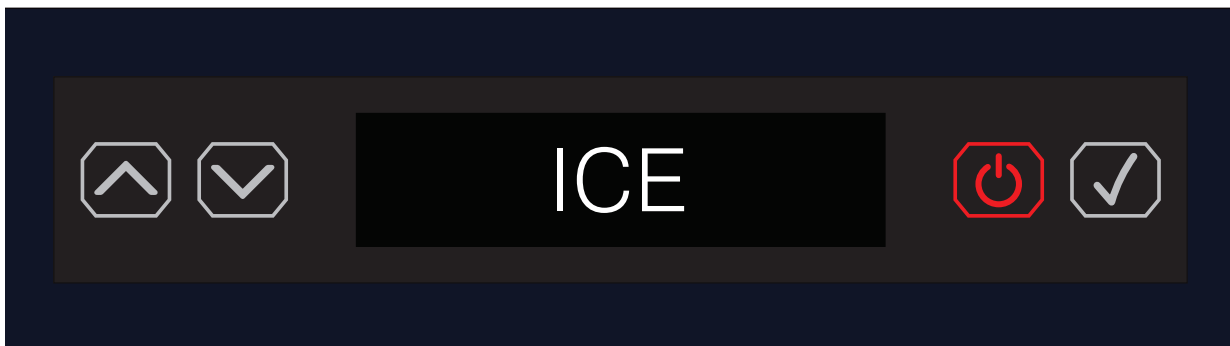

2. The ice machine powers off and nothing is displayed.

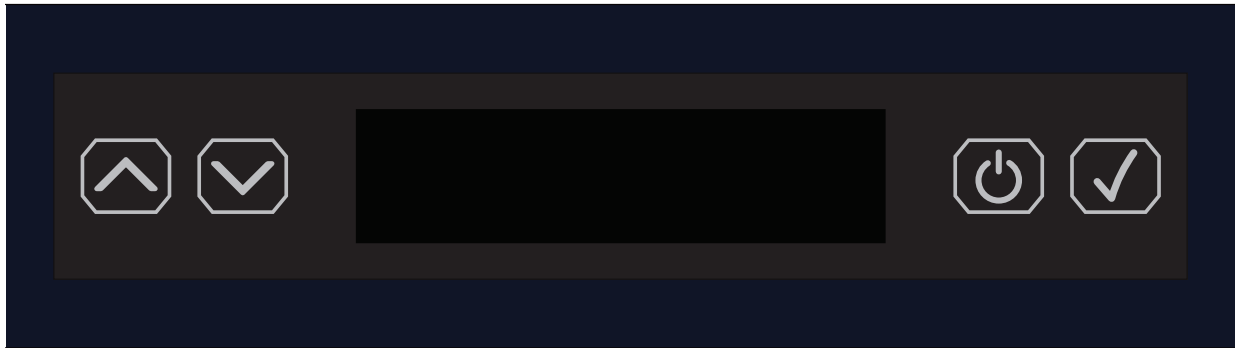

ENTER THE DISPLAY OF MENU ITEMS

1. Press the ENTER button (✓).

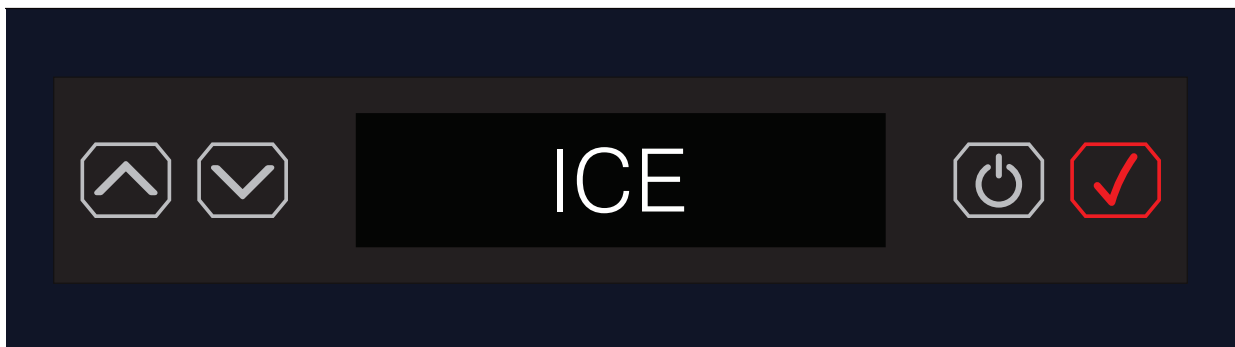

2. The display shows the first menu item CLEAN ICE MACHINE.

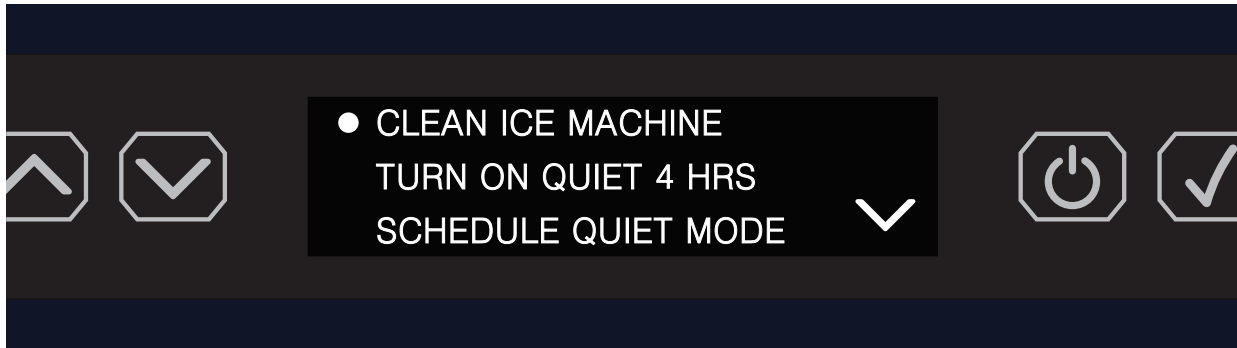

3. Scroll to the next menu item by pressing the DOWN ARROW button ().

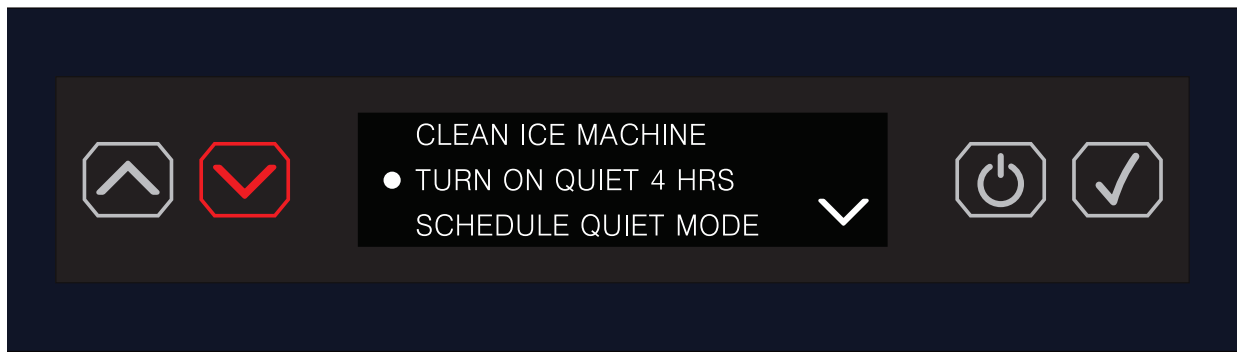

4. Scroll to the next menu item by pressing the DOWN ARROW button ().

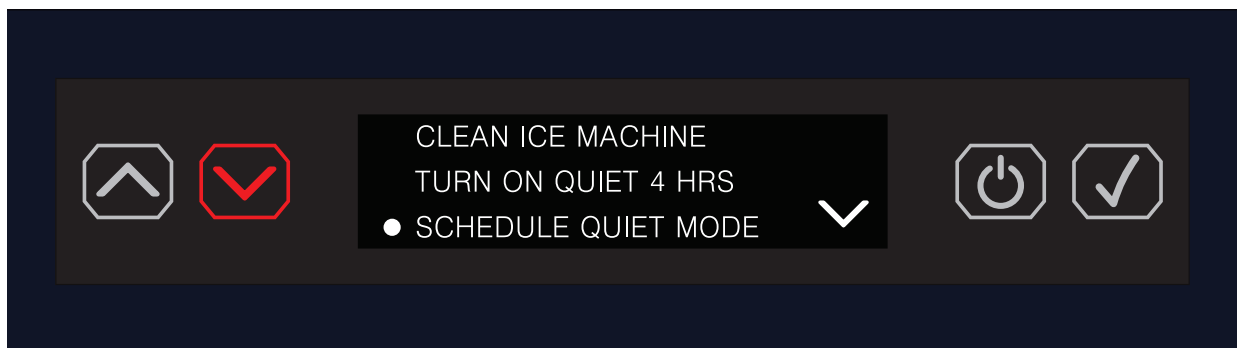

5. Scroll to the next menu item by pressing the DOWN ARROW button ().

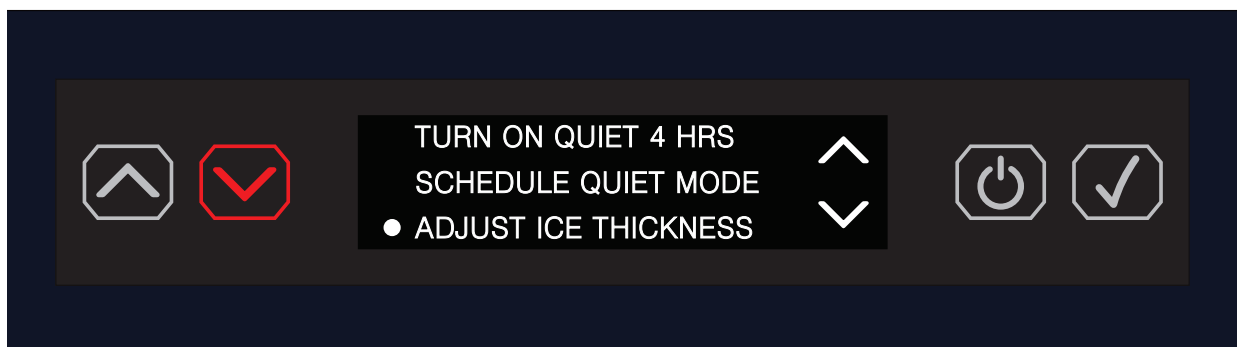

6. Select the desired setting by pressing the ENTER button (✓).

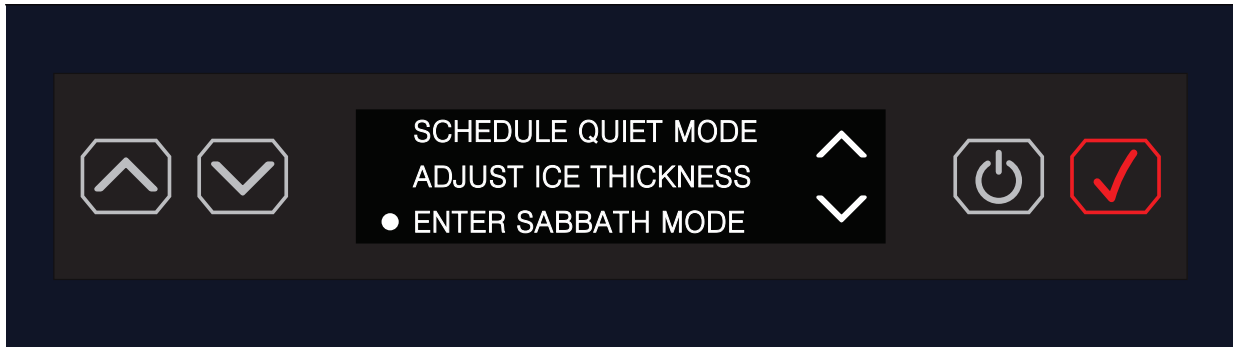

7. To exit the menu, scroll down to EXIT MENU, then press the ENTER button (✓).

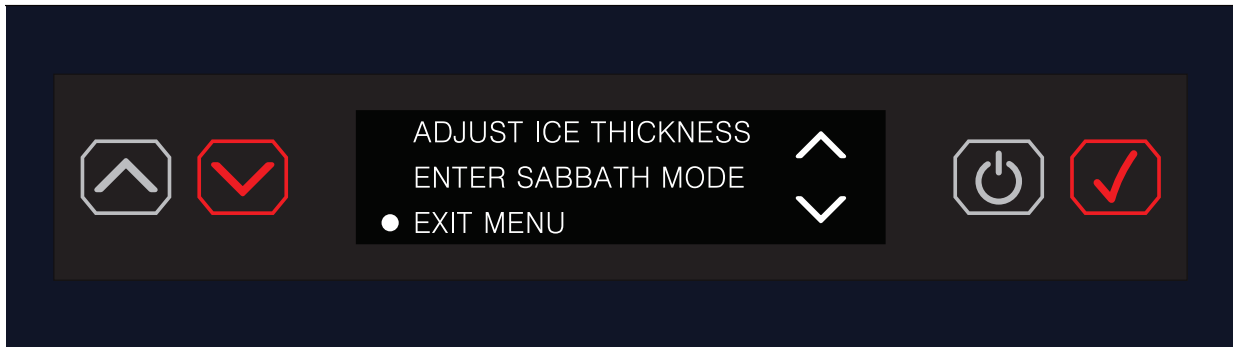

NOTE: Once a menu item is selected, it takes the user directly to the particular setting.

RUNNING THE CLEAN ICE MACHINE CYCLE

1. Press the ENTER button (✓) to enter the menu.



2. Press the ENTER button (✓) to select CLEAN ICE MACHINE.

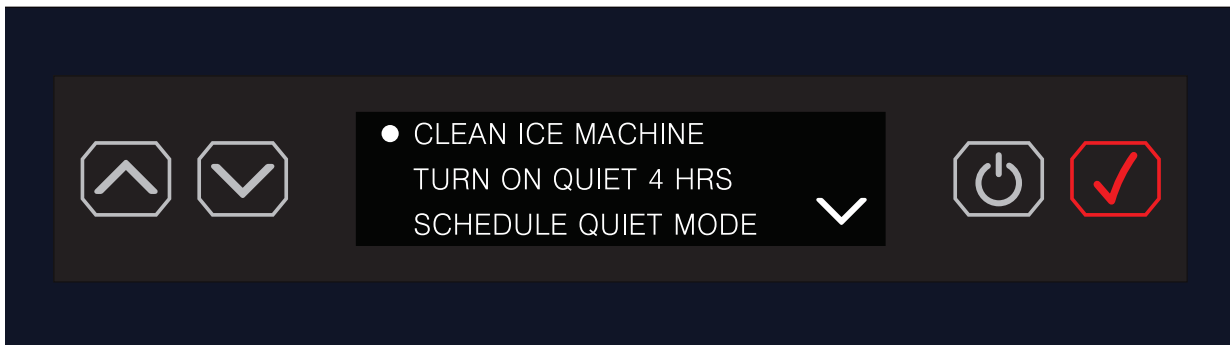

3. To CONFIRM the CLEANING function, press the ENTER button (✓) again.

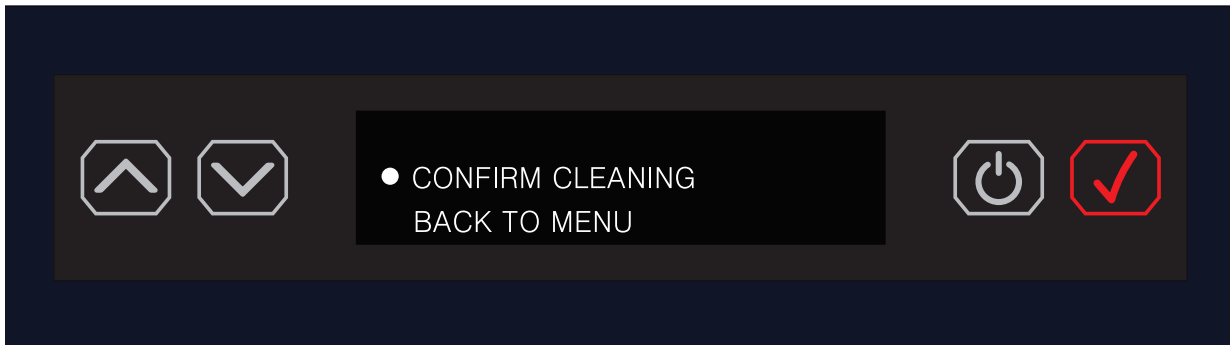

4. The display shows CLEANING and the time remaining for the CLEAN ICE MACHINE cycle to complete.

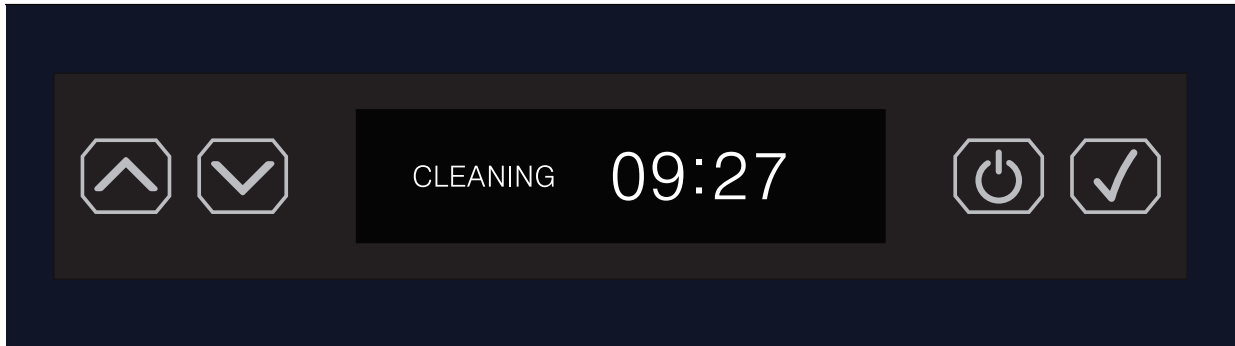

NOTE: Once the CLEAN cycle has completed the display reverts back to the default ICE screen.

SETTING QUIET MODE 4 HOURS

1. Press the ENTER button (✓) to enter the menu.

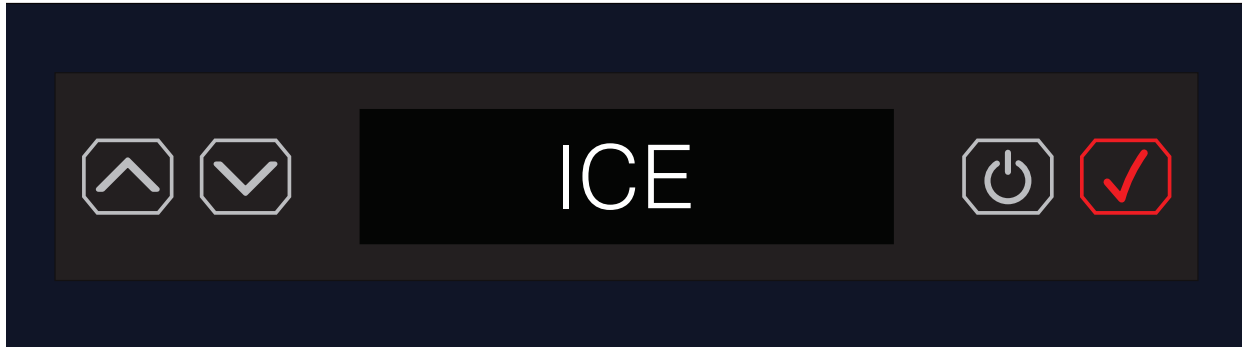

2. Scroll down to TURN ON QUIET 4 HOURS setting and press the ENTER button (✓).

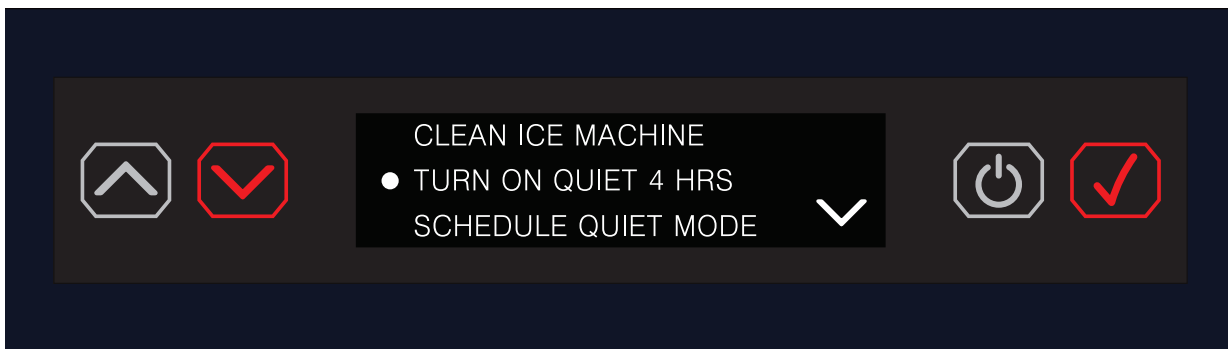

3. QUIET MODE is set and new ice production is now suspended for 4 hours.

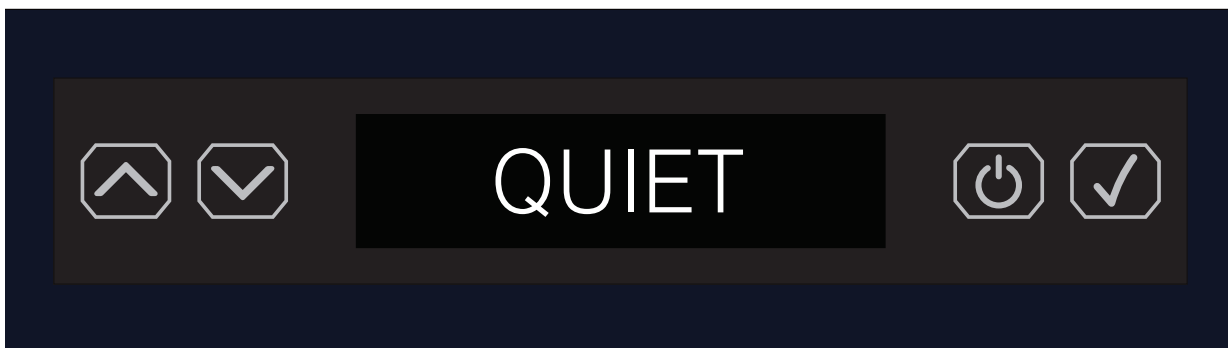

NOTE: QUIET MODE 4 HOURS suspends ice production for 4 hours and otherwise functions normally.

EXITING OR STOPPING QUIET MODE 4 HOURS

1. Press the ENTER button (✓) to enter the menu.



2. Scroll down to TURN OFF QUIET 4 HOURS setting and press the ENTER button (✓).

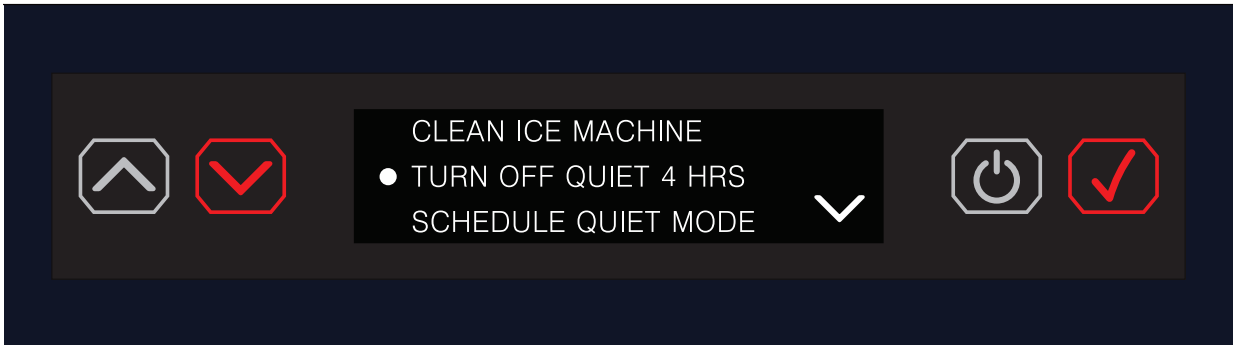

3. The display reverts back to the default ICE screen and is no longer in QUIET mode.

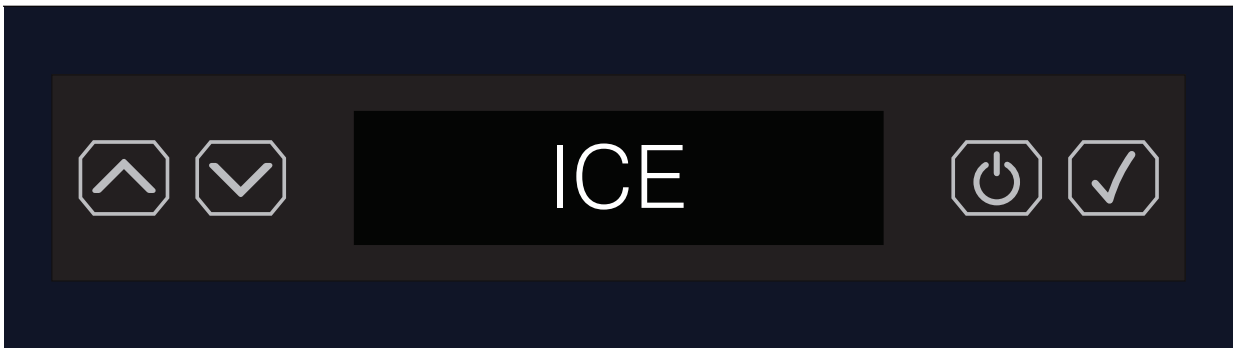

SETTING SCHEDULE QUIET MODE

1. Press the ENTER button (✓) to enter the menu.



2. Scroll down to the SCHEDULE QUIET MODE setting.

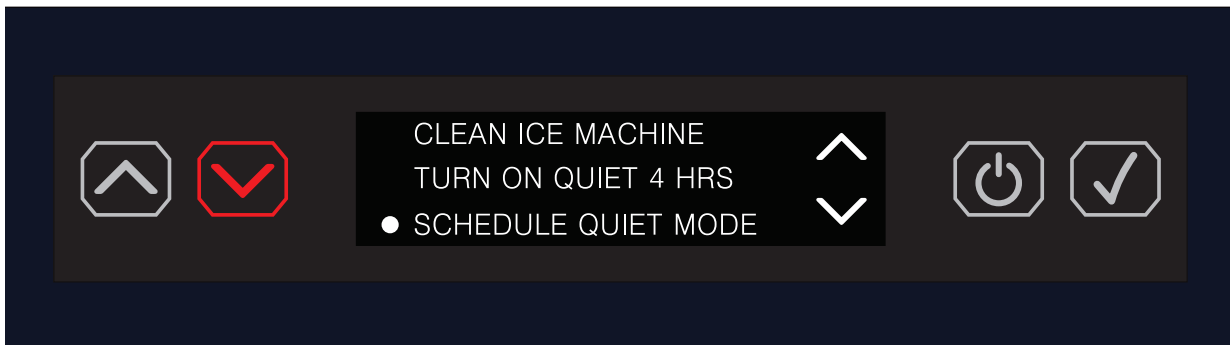

3. Press the ENTER button (✓).

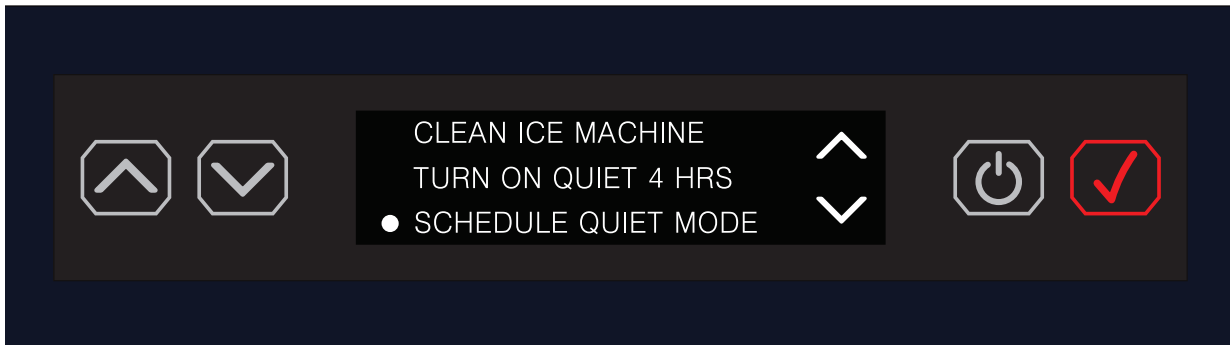

- The user is then prompted to set the clock time first, prior to setting the desired SCHEDULE QUIET MODE setting, pressing the ENTER button (✓).

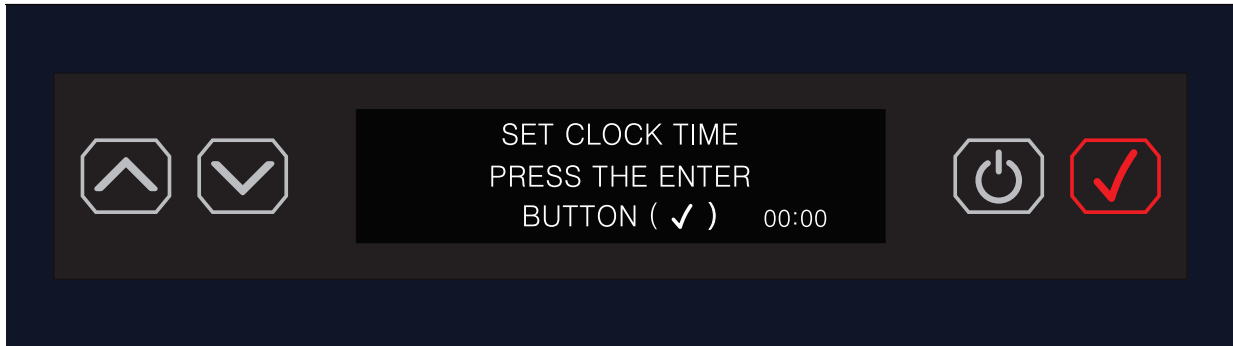

- The display will show the clock at 00:00 and prompt the user to set the hour with the hour position flashing the 00.

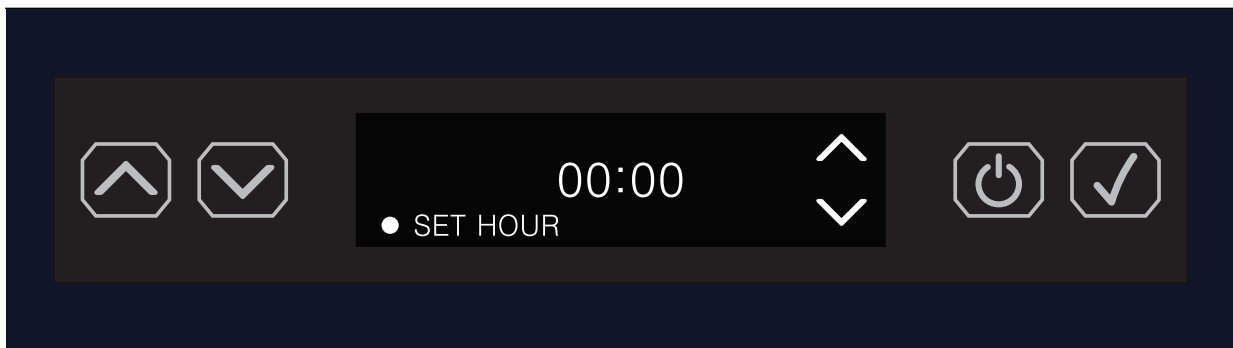

- Using the UP / DOWN arrow button set the HOUR.

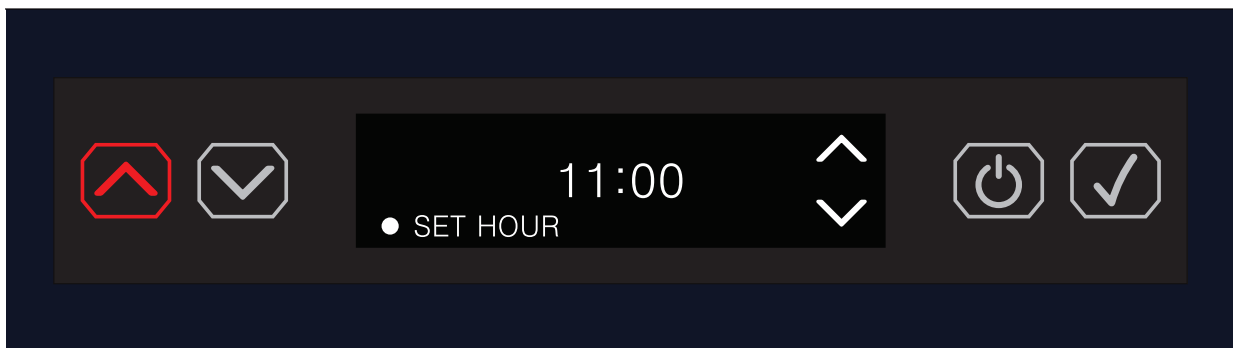

7. Once the HOUR is set, press the ENTER button (✓) and the display will show the minutes position blashing the 00.

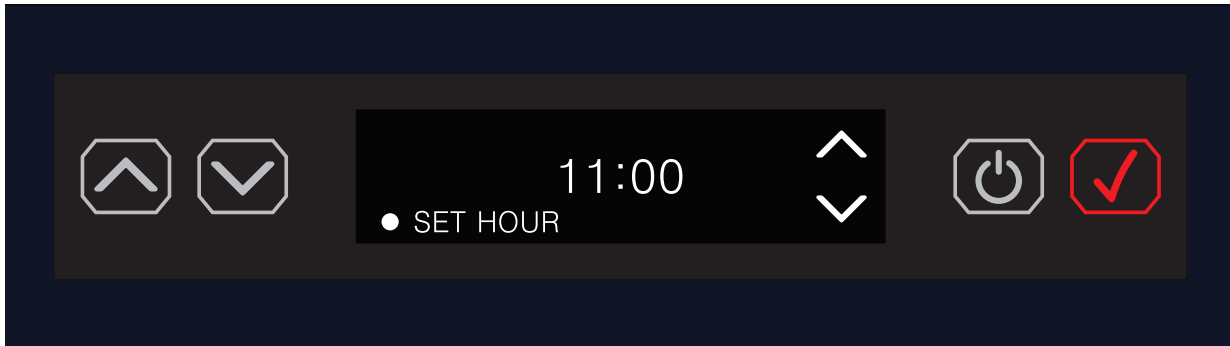

8. Using the UP / DOWN arrow button set the MINUTES.

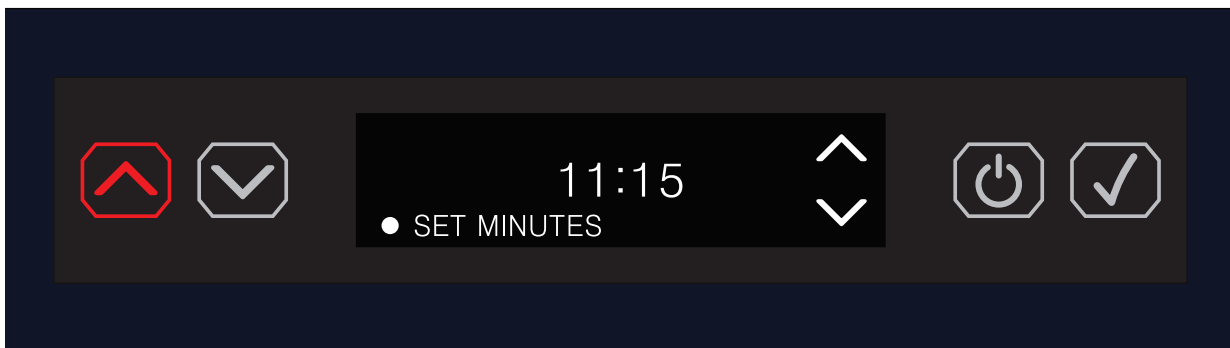

9. Once the MINUTES are set, press the ENTER button (✓).

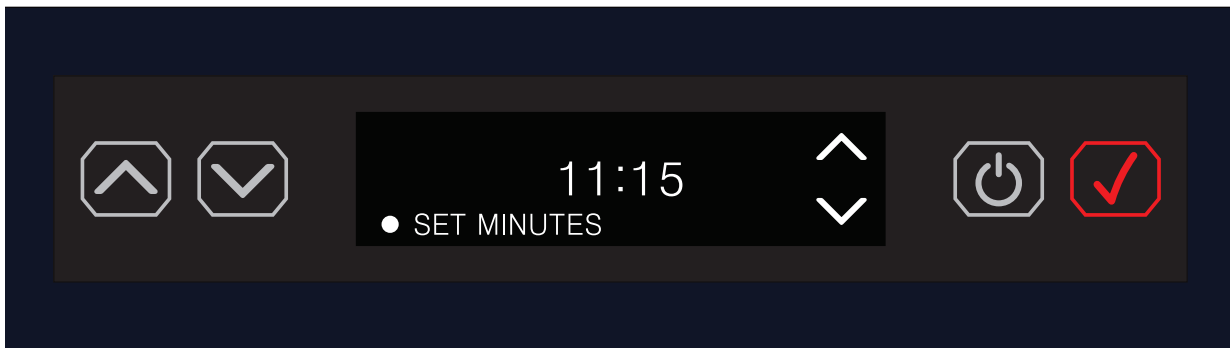

10. Using the UP / DOWN arrow button select AM or PM and the AM / PM will flash until the user makes the selection.

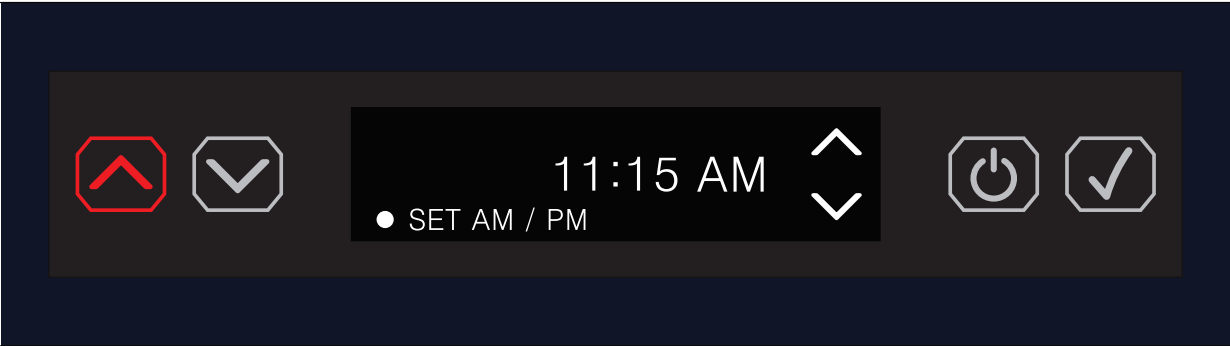

11. Once the AM/PM is set, press the ENTER button (✓).

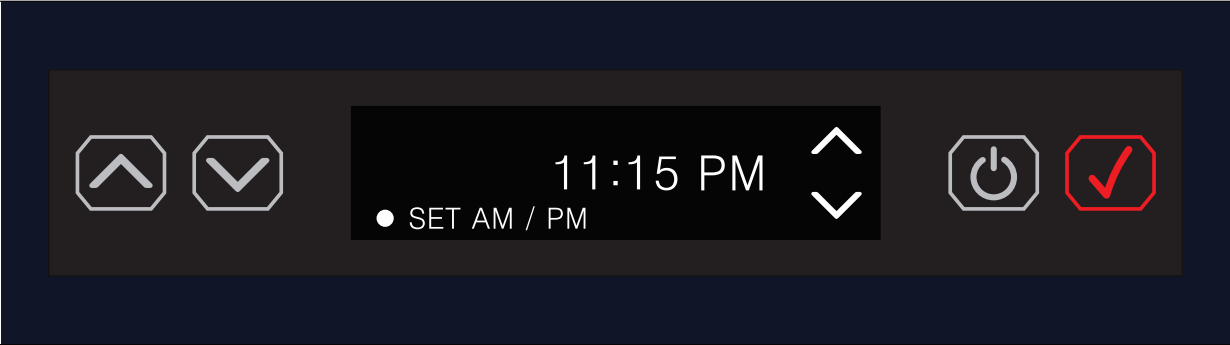

12. Once the time is properly set, the display prompts the user to set the START TIME HOUR for the SCHEDULE QUIET MODE pressing the UP or DOWN arrow and the display will show the hour section flashing 00.

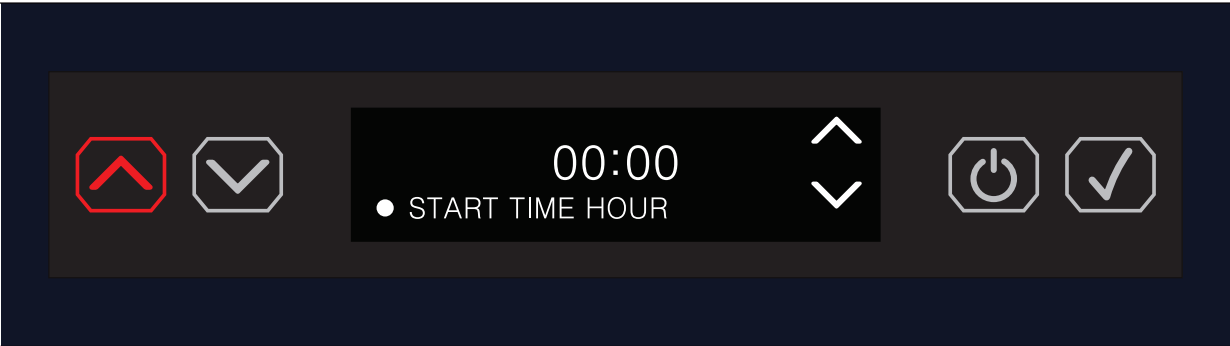

13. Using the UP / DOWN arrow button set the START TIME HOUR.

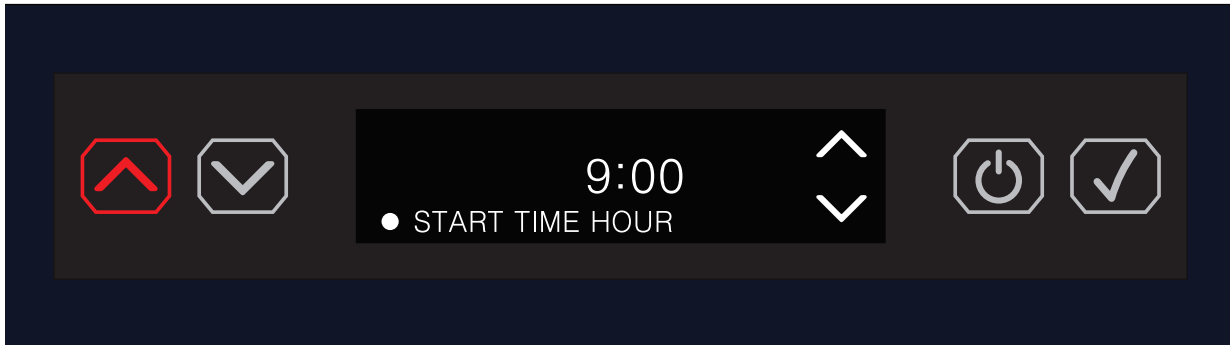

14. Once the HOUR is set, press the ENTER button (✓) and the display will show the minutes section flashing 00.

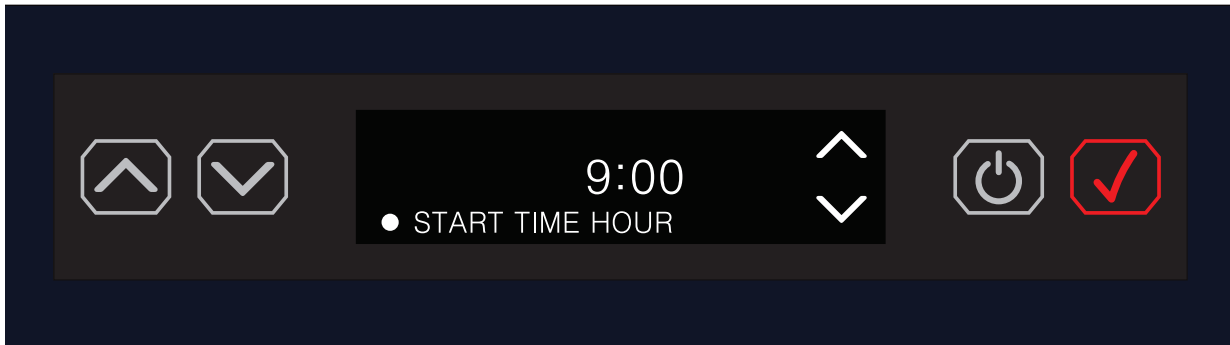

15. Using the UP / DOWN arrow button set the START TIME MINUTES.

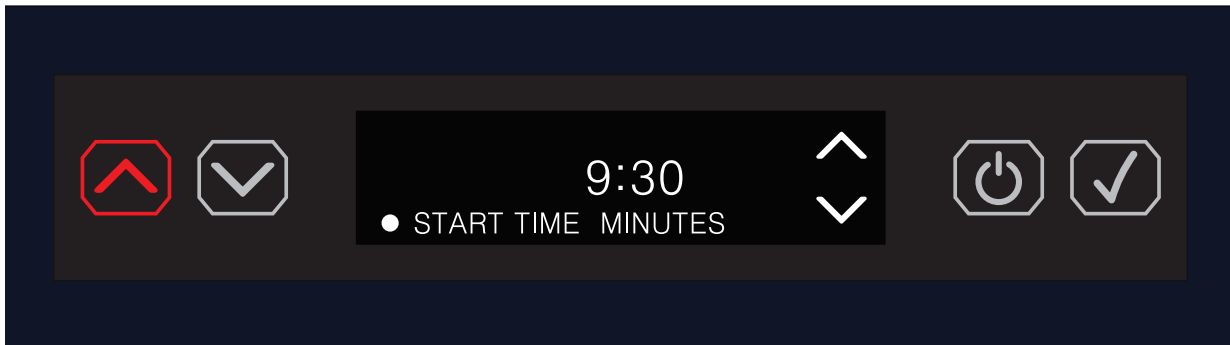

16. Once the MINUTES are set, press the ENTER button (✓).

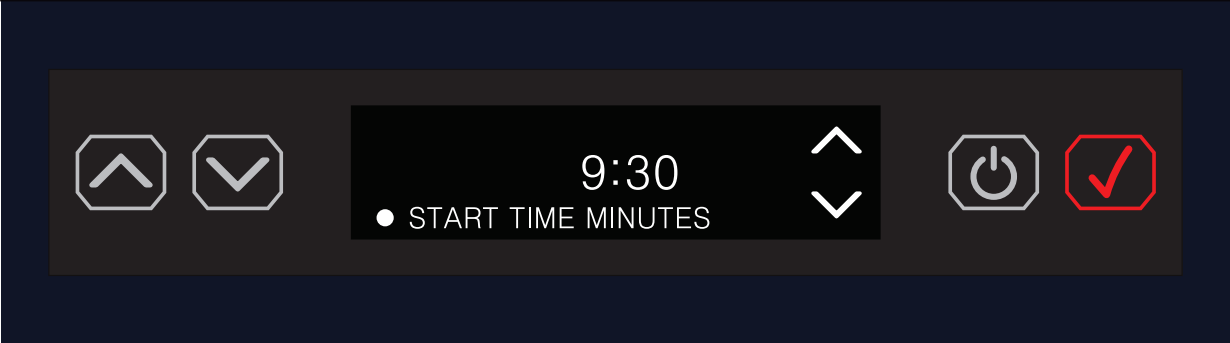

17. Using the UP / DOWN arrow button select START TIME AM or PM and the AM / PM will flash until the user makes a selection.

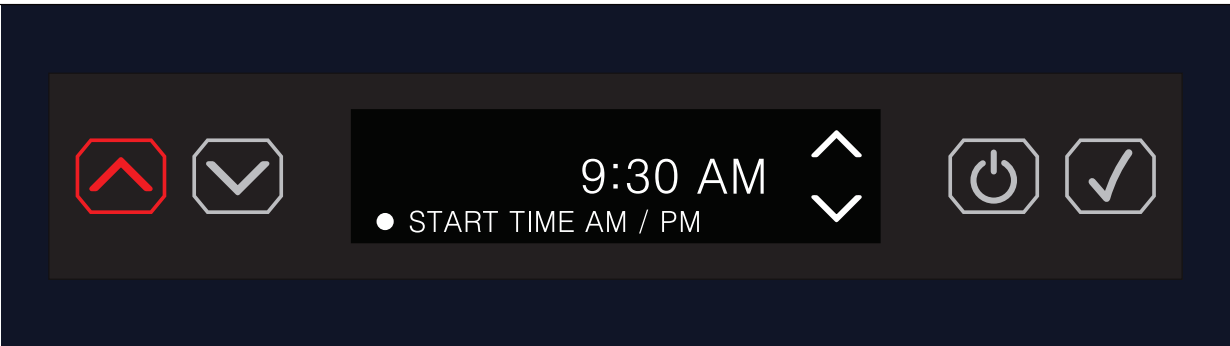

18. Once the AM/PM is set, press the ENTER button (✓).

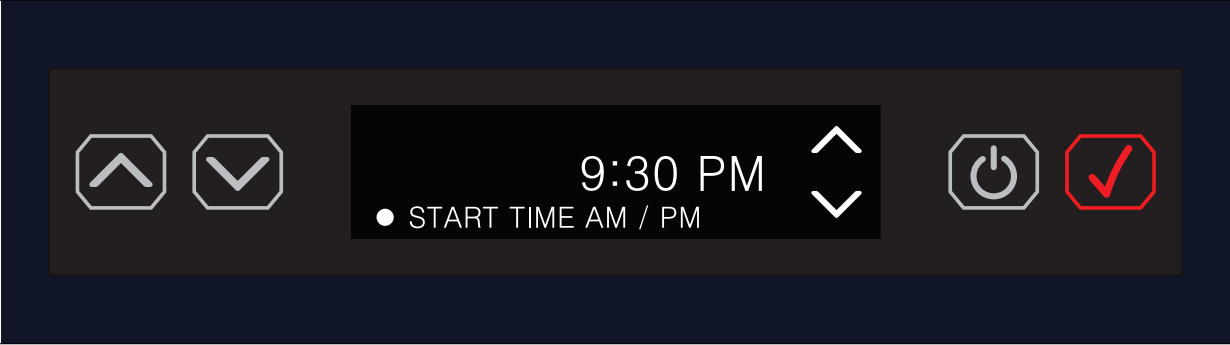

19. Once the START TIME is properly set, the display prompts the user to set the END TIME HOUR for the SCHEDULE QUIET MODE pressing the UP or DOWN arrow and the display will show the hours section flashing 00.

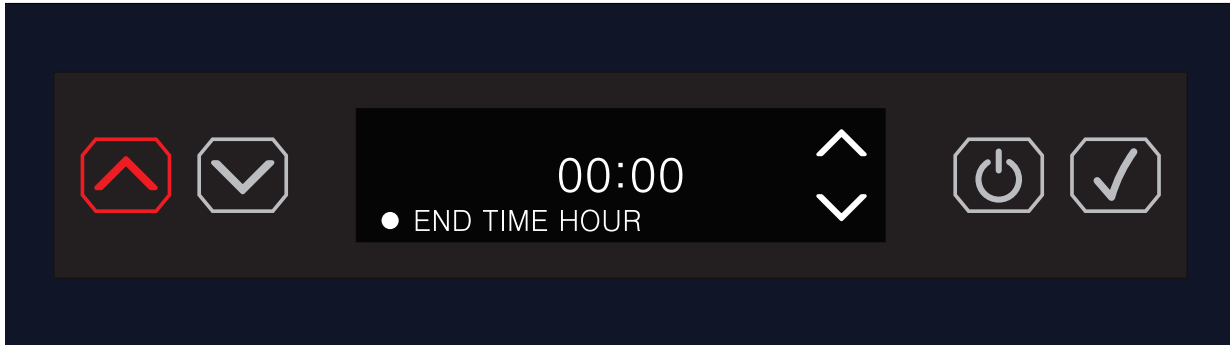

20. Using the UP / DOWN arrow button select the END TIME HOUR.

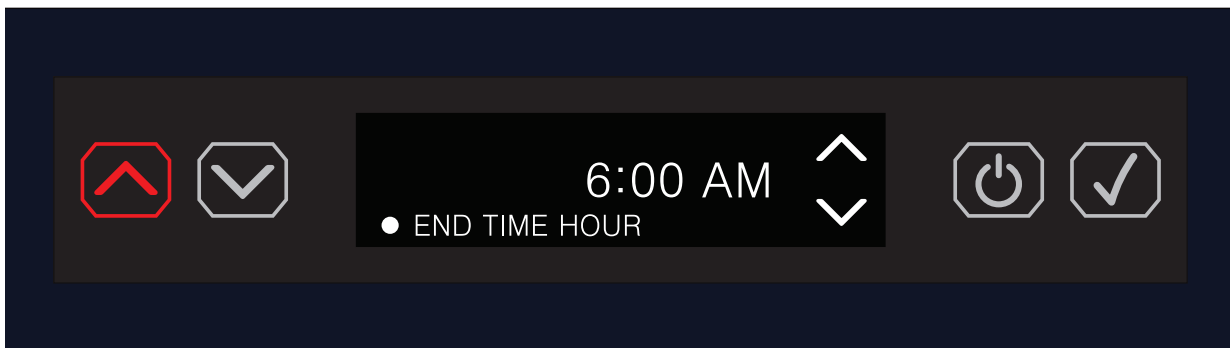

21. Once the HOUR is set, press the ENTER button (✓).

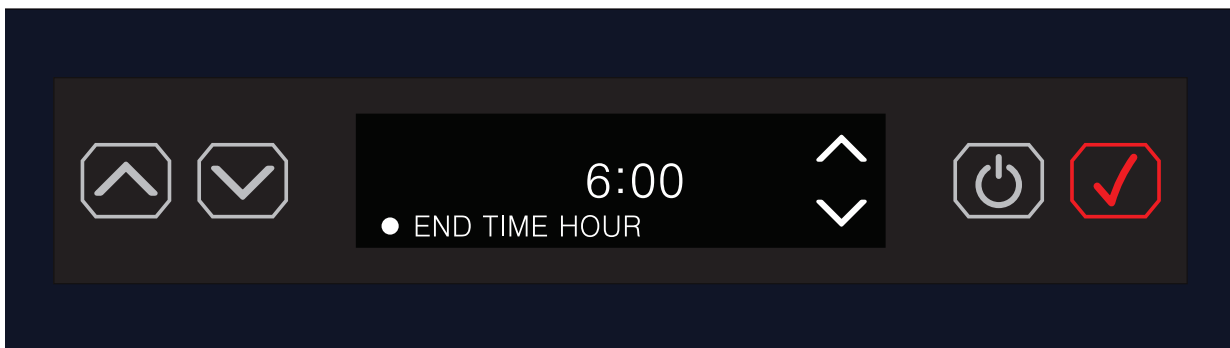

22. Using the UP / DOWN arrow button set the END TIME MINUTES and the display will show the minutes section flashing 00.

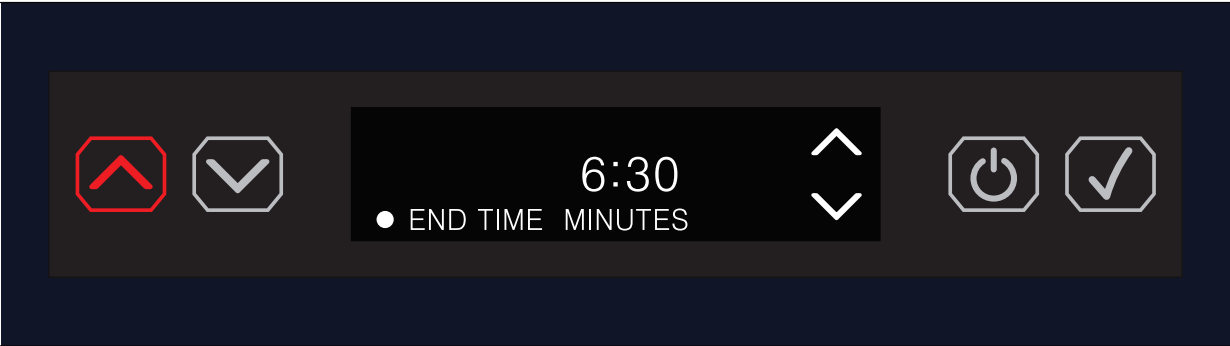

23. Once the MINUTES are set, press the ENTER button (✓).

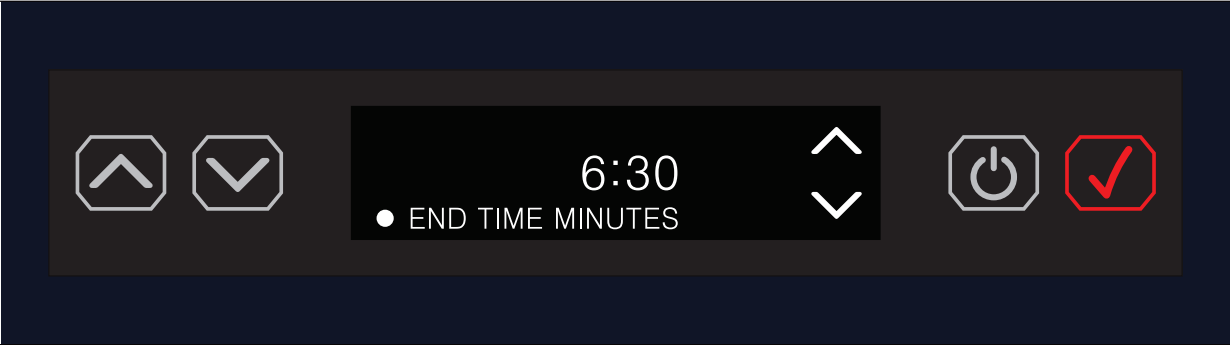

24. Using the UP / DOWN arrow button select END TIME AM or PM and the AM / PM will flash until the user makes a selection.

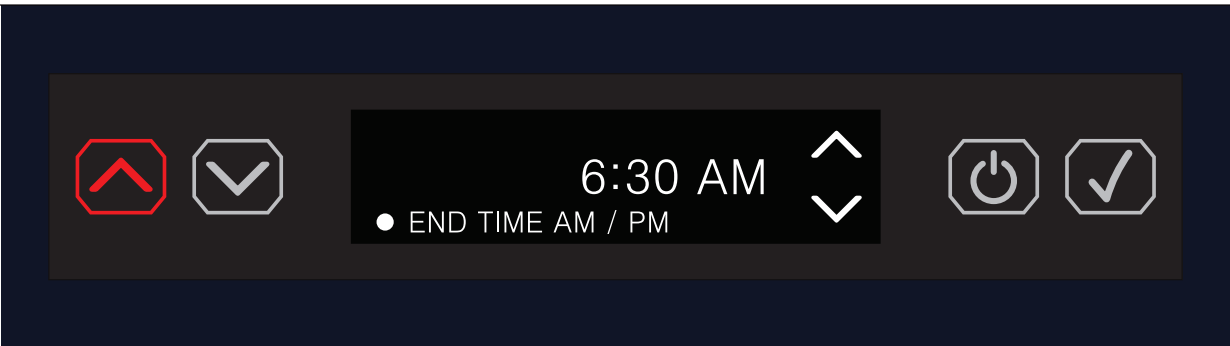

25. Once the AM/PM is set, press the ENTER button (✓).

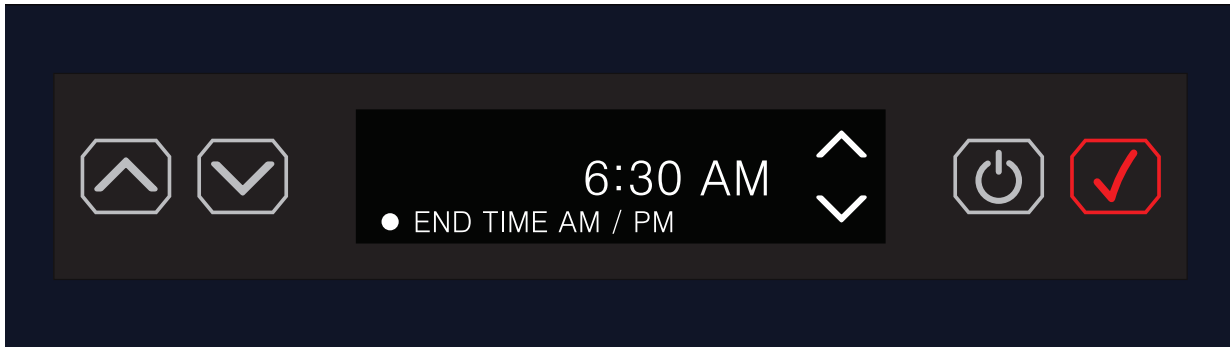

26. SCHEDULE QUIET MODE is now set and new ice production is suspended for the scheduled duration. The display will show QUIET, the crescent moon icon and the time set.

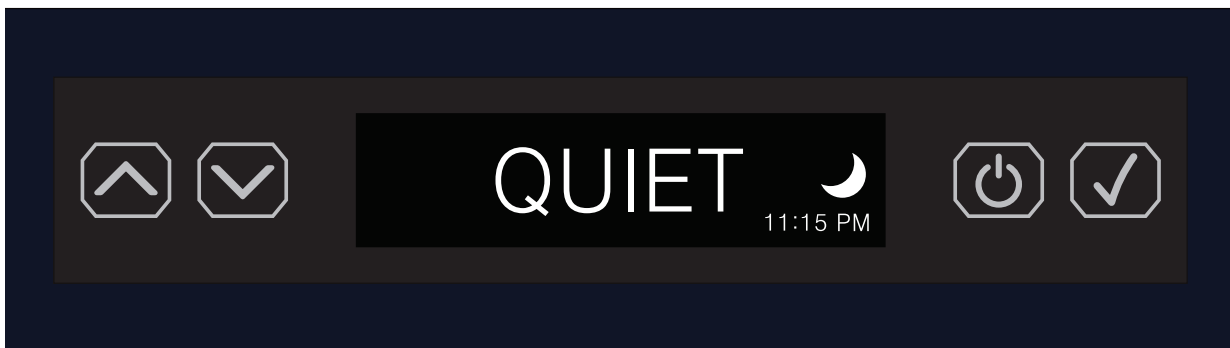

NOTE: QUIET will display ONLY during the set duration of QUIET MODE. Otherwise the display will show the default ICE screen. Additionally, the crescent moon icon will display ONLY when in SCHEDULED QUIET MODE.

ADJUSTING ICE THICKNESS

1. Press the ENTER button (✓).

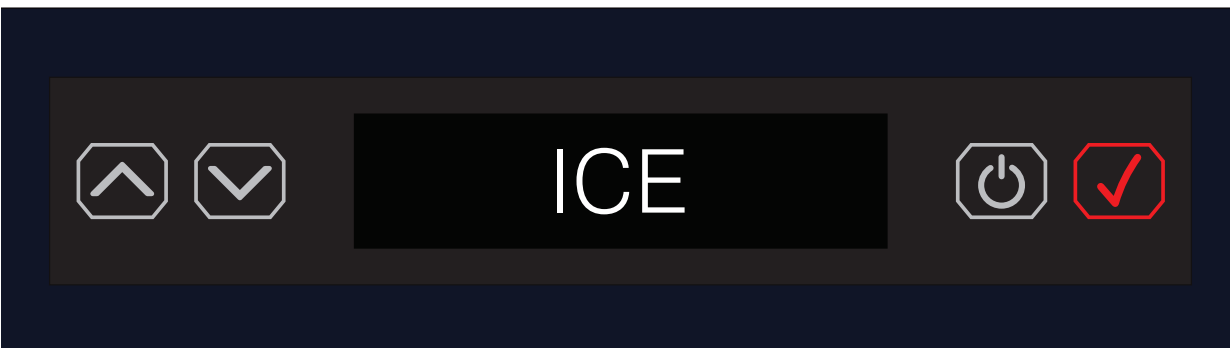

2. Scroll to ADJUST ICE THICKNESS and press the ENTER button (✓).

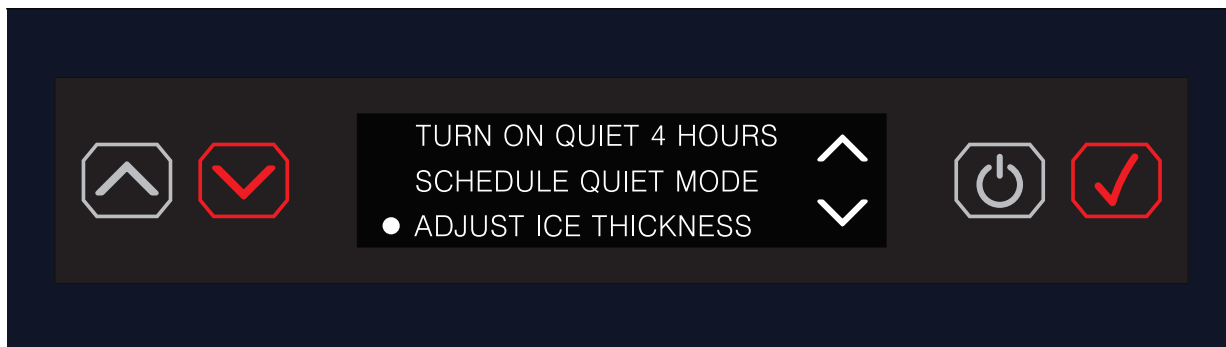

3. Press the UP or DOWN ARROW button (⤴ ⤵) to scroll to desired setting.

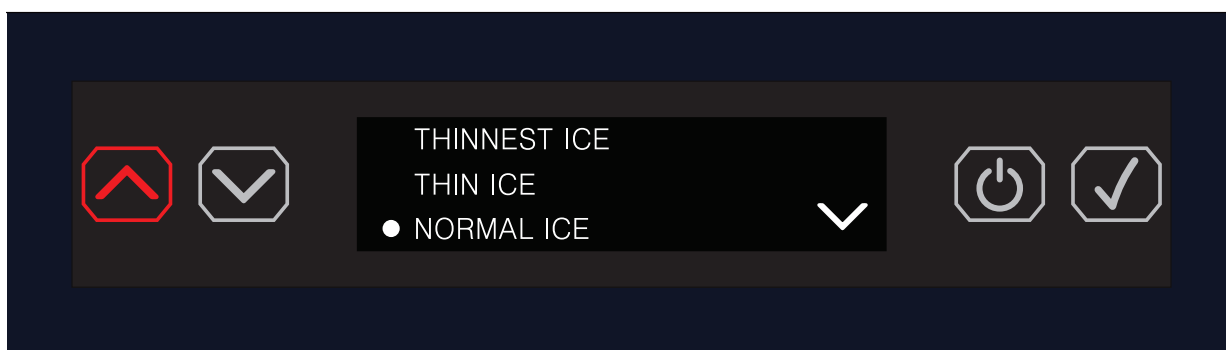

4. Press the ENTER button (✓) to scroll to desired setting.

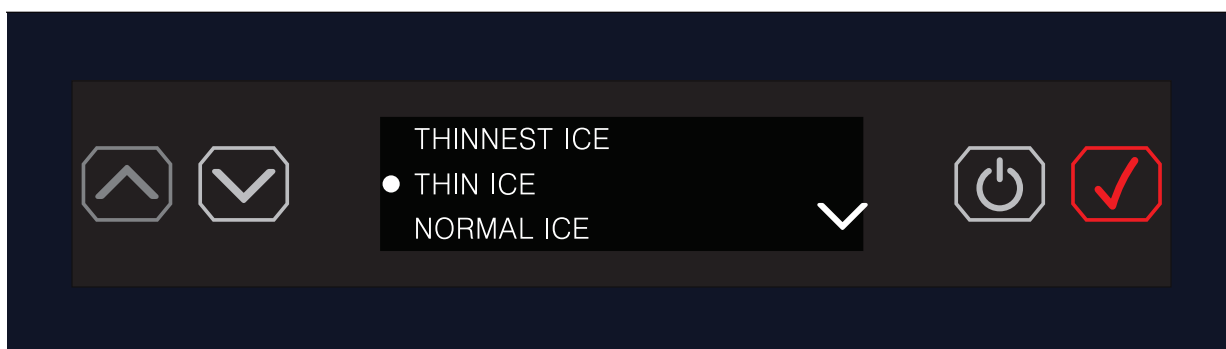

5. Press the DOWN ARROW button () to scroll to desired setting.

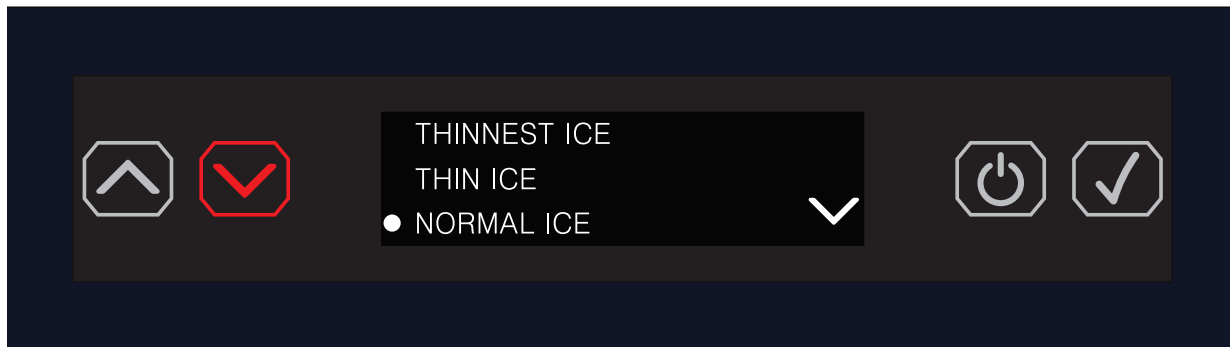

6. Press the DOWN ARROW button () to scroll to the desired setting.

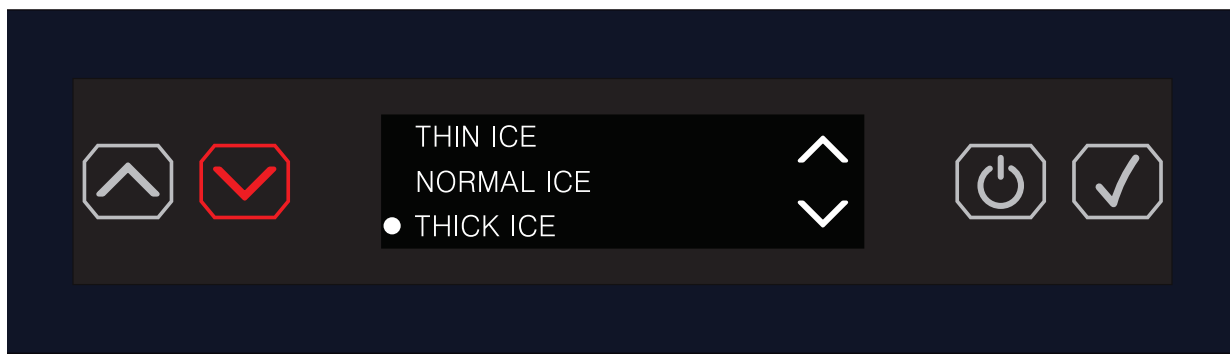

7. Press the DOWN ARROW button () to scroll to the desired setting.

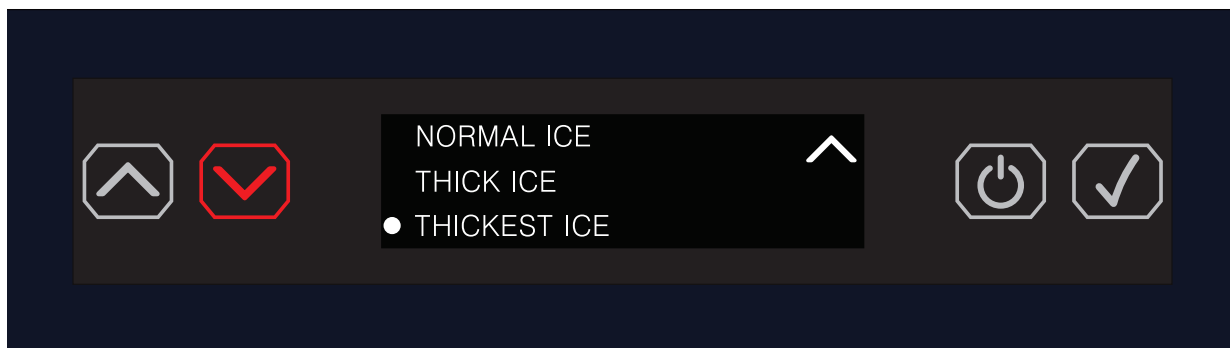

8. Press the ENTER button (✓) to select the desired setting.

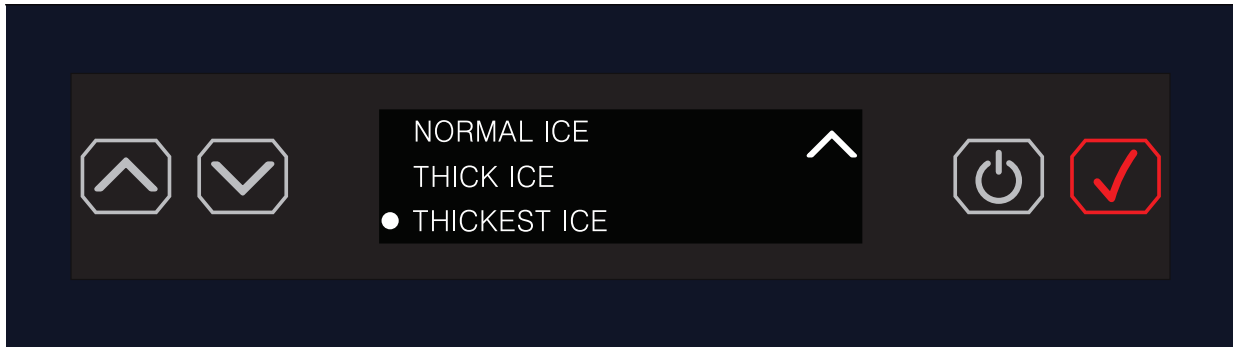

NOTE: You can either wait 30 seconds or press the ENTER button (✓) to exit the ice thickness display and revert to ICE displayed.

ENTER SABBATH MODE

1. Press the ENTER button (✓) to enter the menu.

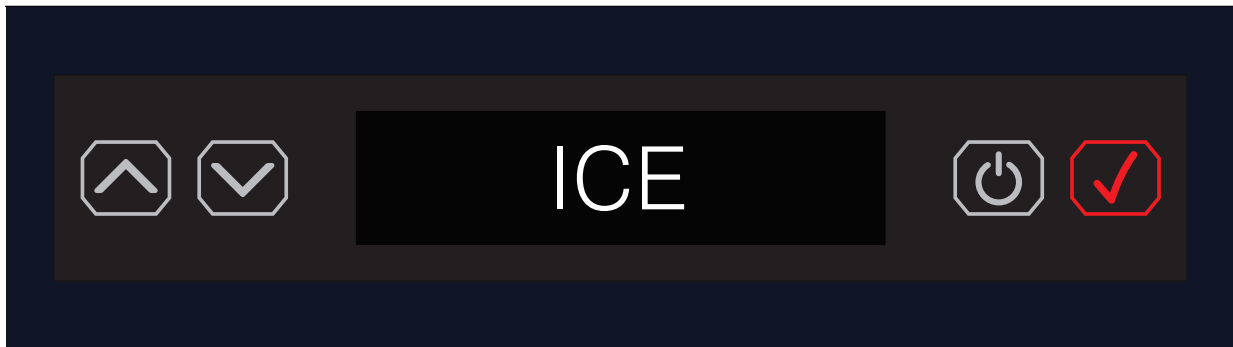

2. Scroll down to the ENTER SABBATH MODE setting.

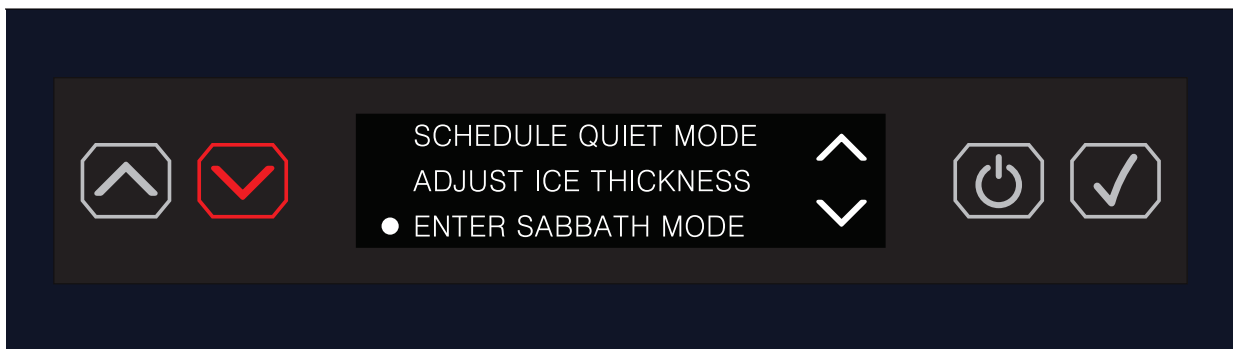

3. Press the ENTER button (✓).

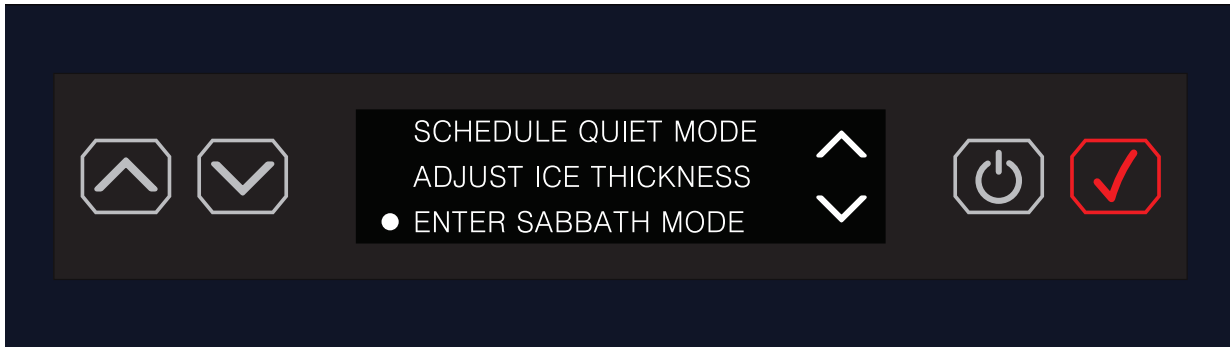

4. The display shows nothing but is still running and in SABBATH MODE.

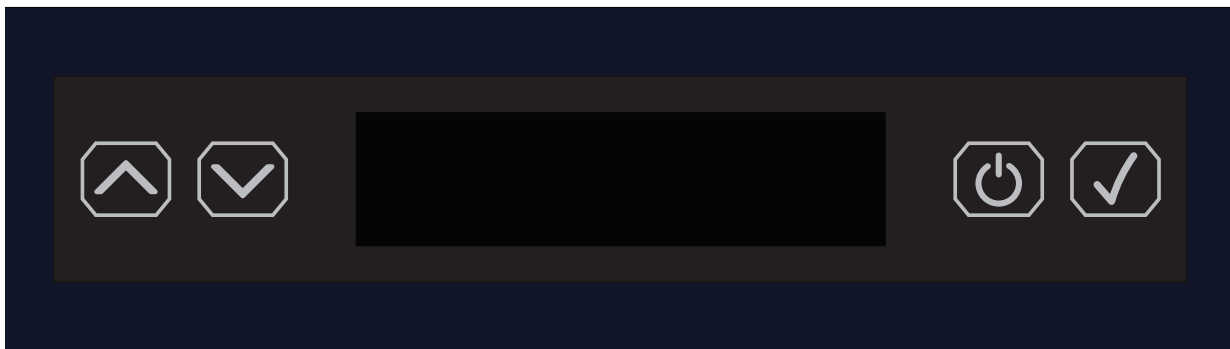

NOTE: Sabbath mode suspends ice production during the setting and the interior light does not come on when the door is opened.

EXITING OR CANCELLING SABBATH MODE

1. To exit or cancel SABBATH MODE, press the ENTER button (✓).

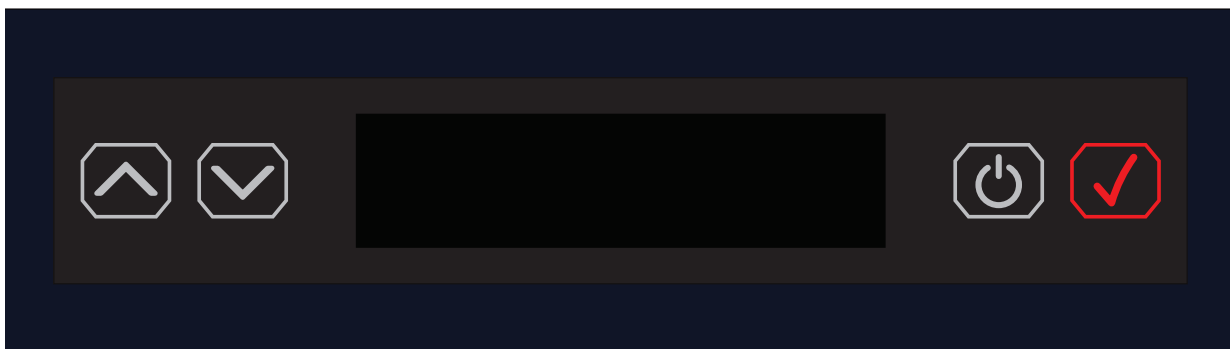

2. The display reverts to the default ICE screen.

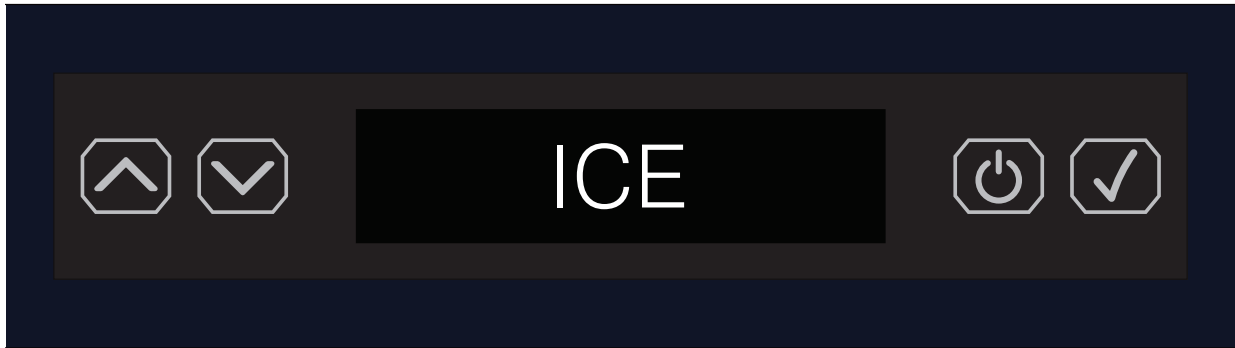

NOTE: In the event of a power failure during Sabbath mode, Sabbath mode remains in effect and does not need to be reset.

EXITING THE MENU

1. To exit the menu, scroll down to EXIT MENU, then press the ENTER button (✓).

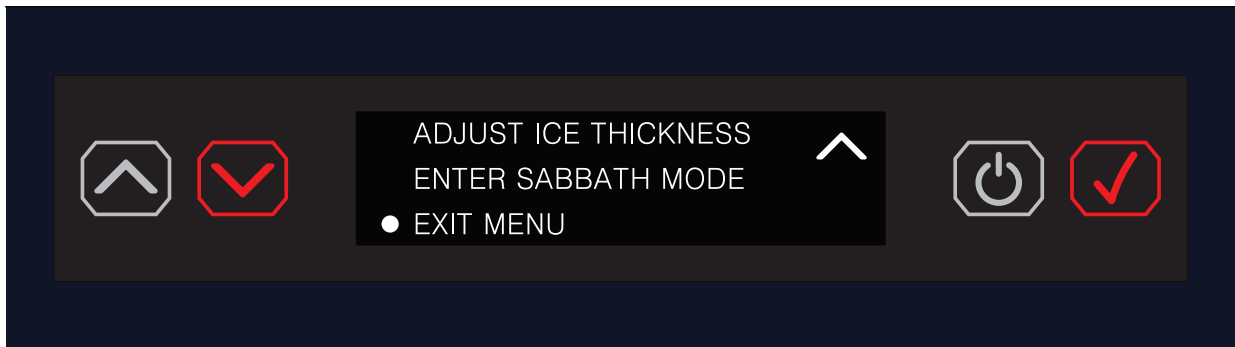

2. Exiting the MENU reverts back to the default display screen.

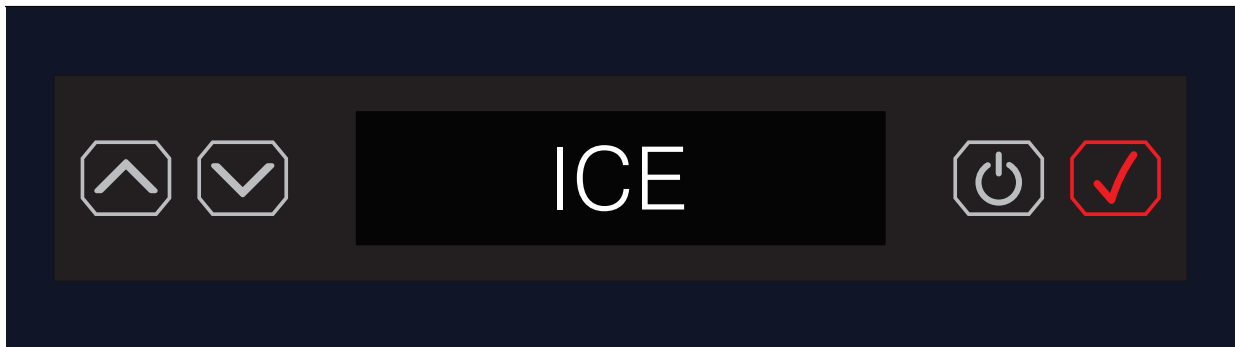

NOTE: Once the MENU is exited, user programmed changes are saved.

CLEAN ALERT INDICATED

1. When the ice machine recognizes that cleaning is needed, CLEAN ICE MACHINE will be displayed. The user must press the ENTER button (✓).

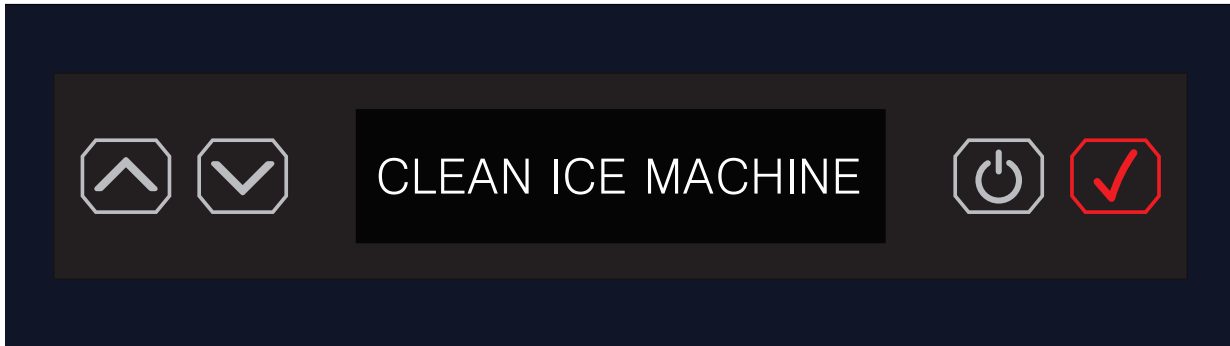

2. To CONFIRM the CLEANING function, press the ENTER button (✓) again.

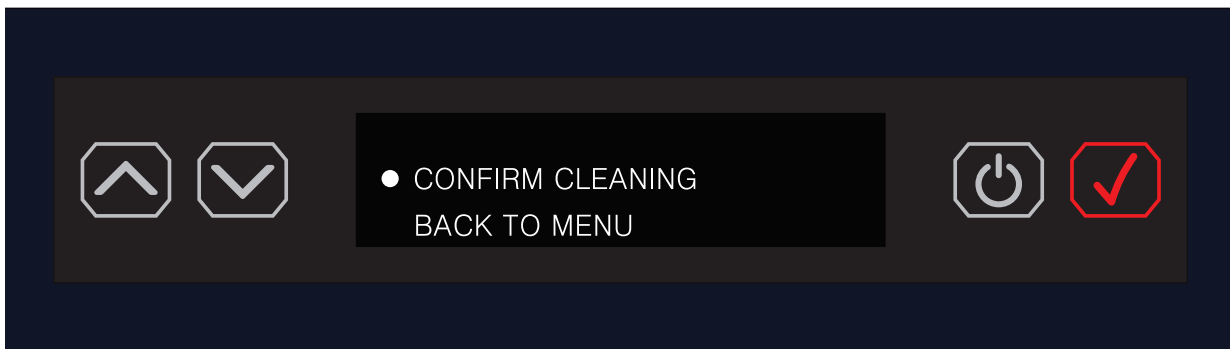

3. The display shows CLEANING and the time remaining for the CLEAN ICE MACHINE cycle to complete.

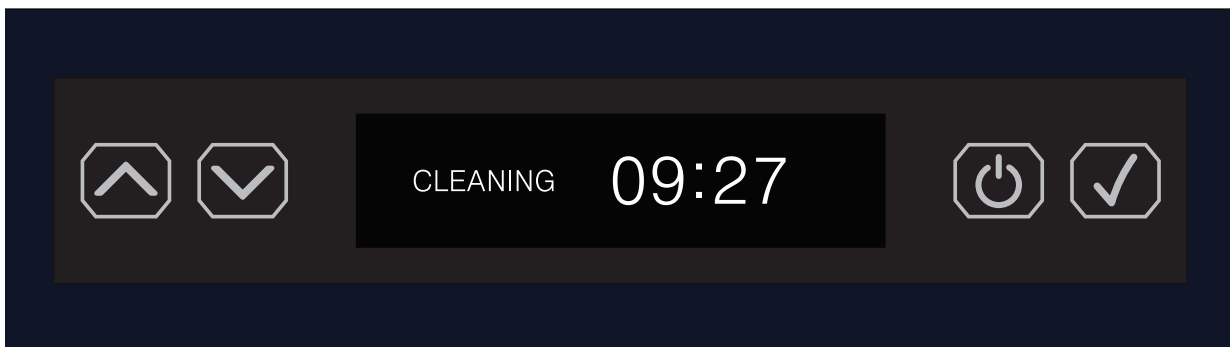

4. When the ice machine has completed the CLEAN cycle, the default ICE screen will display.

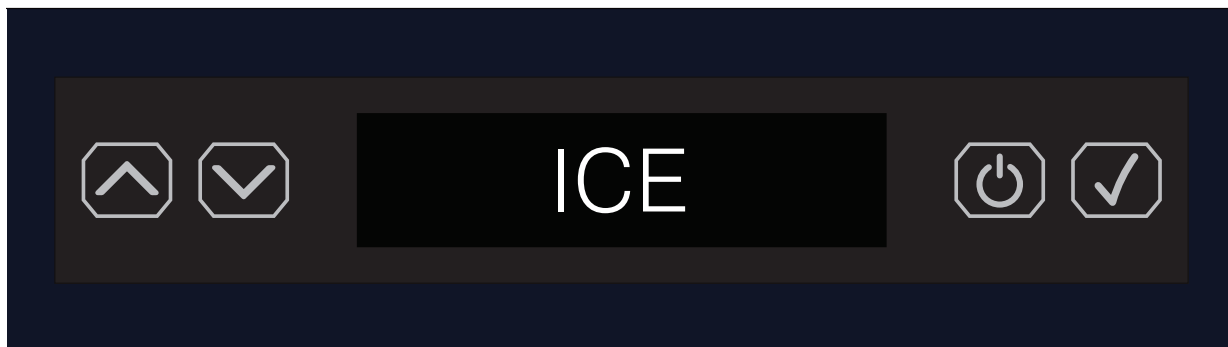

FILTER ALERT INDICATED

1. When the ice machine recognizes that the filter needs to be replaced, the FILTER indicator LED will automatically light.

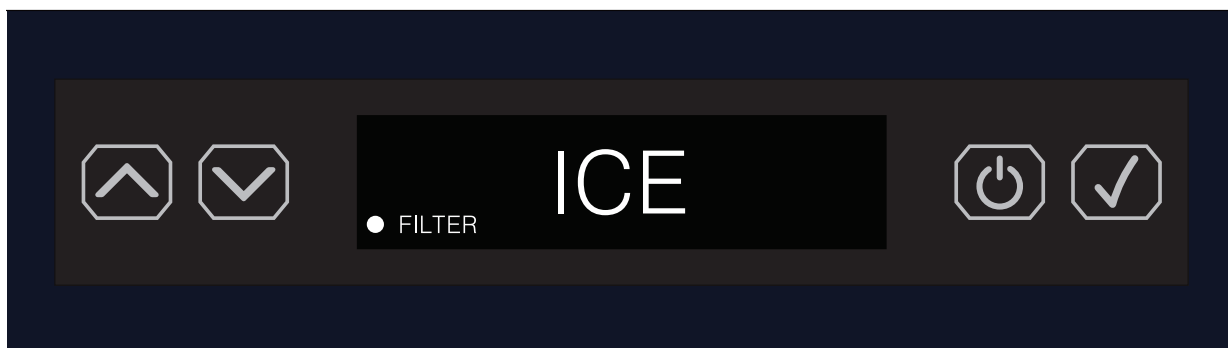

2. Replace the old, dirty FILTER with a new one.

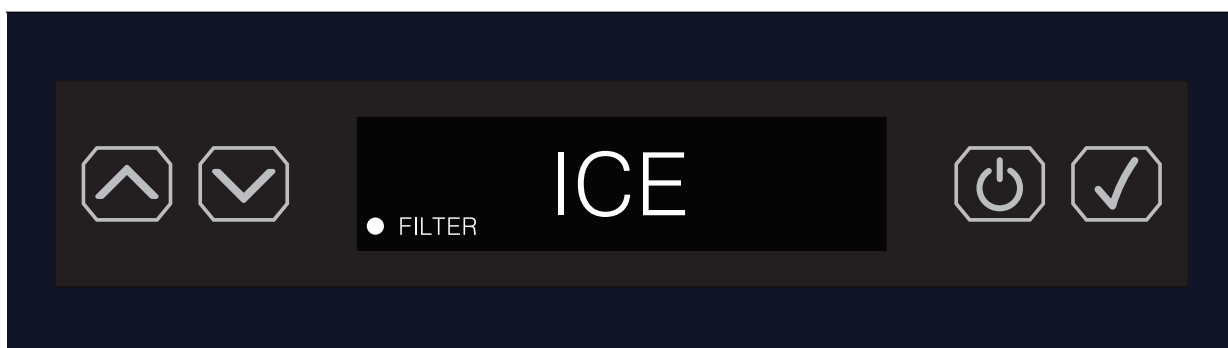

3. Once the FILTER is replaced, the LED indicator will no longer be lit.

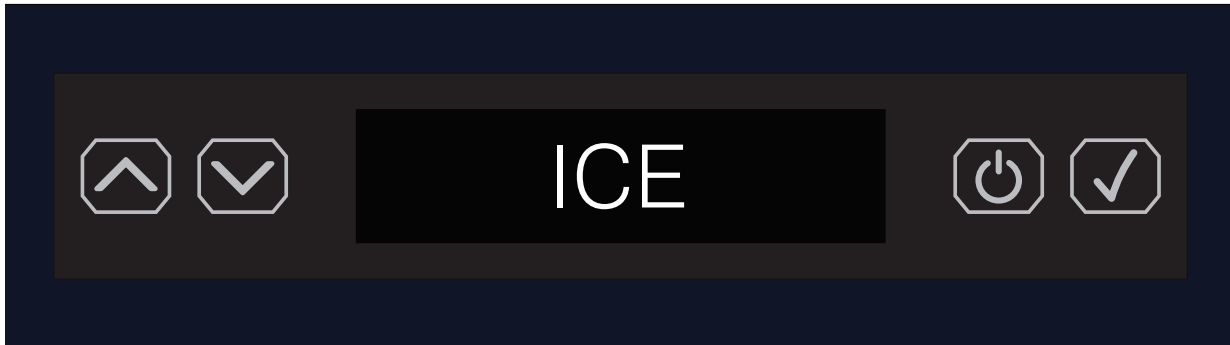

CLEARING SIMPLE ERROR CODES

DOOR OPEN alert is an audible alert and shows DOOR OPEN in the display and the alert automatically clears when the door is closed.

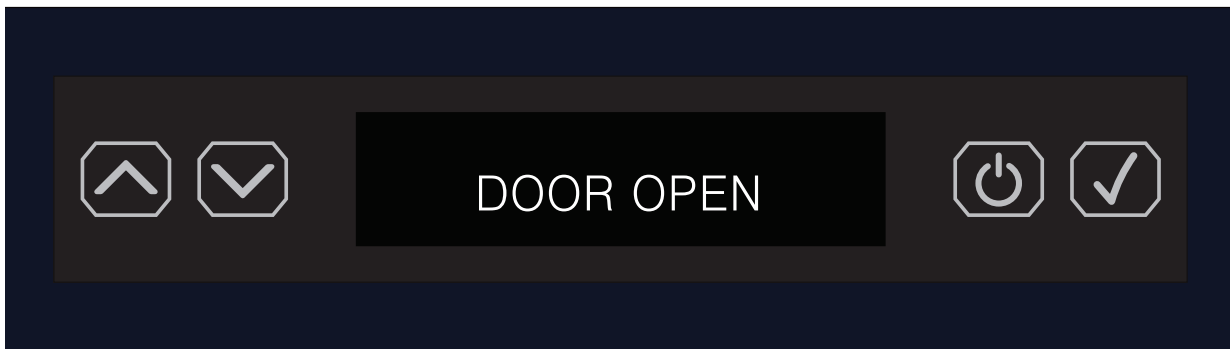

NOTE: The audible alert is 3 beeps that occur every 30 seconds after the door has remained open for more than 2 minutes and automatically clears when the door is properly closed. This methodology applies to any error or alert that requires an audible alert.

ERROR CODES THAT REQUIRE CONTACTING CUSTOMER SERVICE

EXTRA LONG ICE MAKING ALARM: LONG FREEZE is displayed as an ERROR CODE.

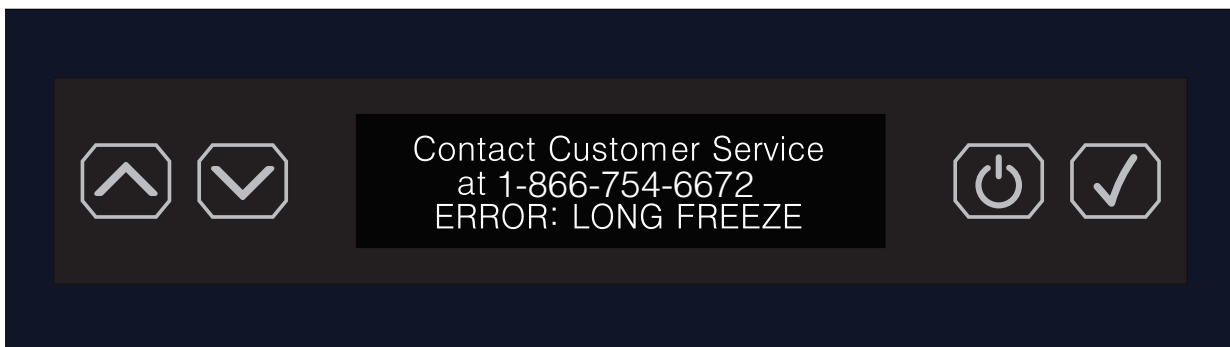

EXTRA LONG ICE HARVEST ALARM: LONG HARVEST is displayed as an ERROR CODE.

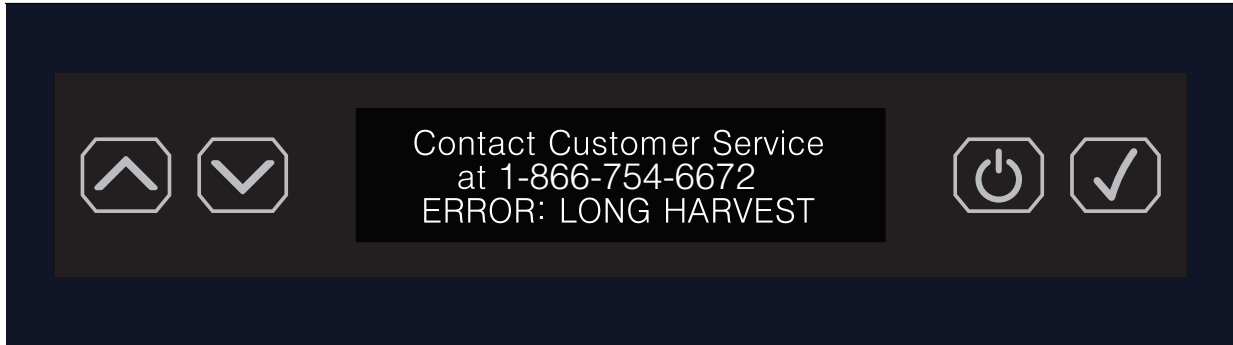

HIGH TEMPERATURE ALARM: COND HOT is displayed as an ERROR CODE.

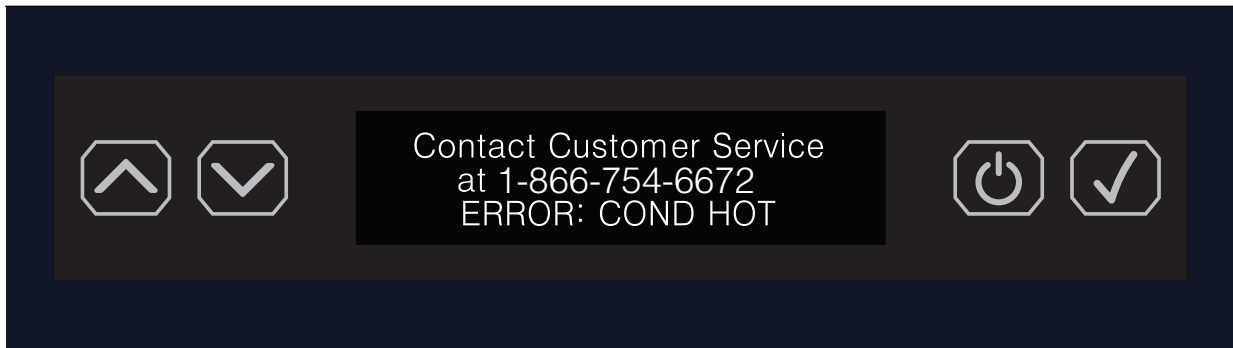

EVAPORATOR SENSOR ALARM: EVAP SENSOR FAULT is displayed as an ERROR CODE.

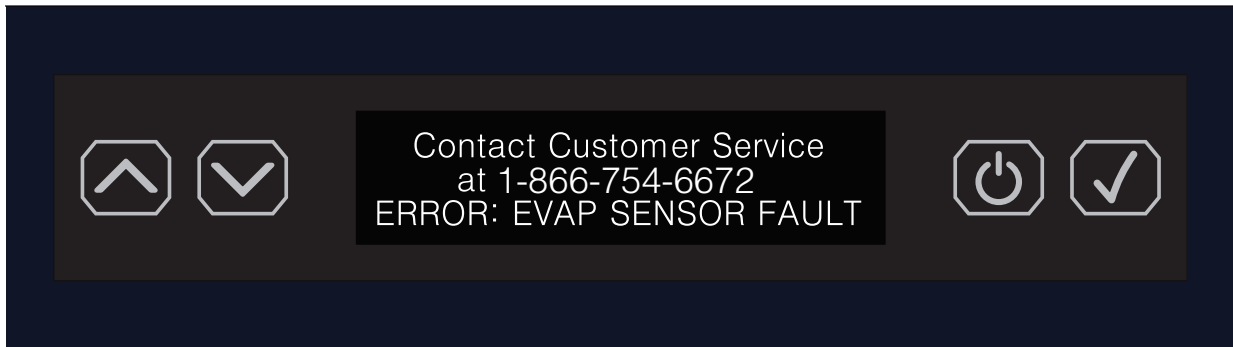

WATER FILTER NOT INSTALLED REMINDER: WATER FILTER NOT INSTALLED is displayed as an alarm. (Only for models with Water Filter)

CONDENSER SENSOR ALARM: COND SENSOR FAULT is displayed as an ERROR CODE.

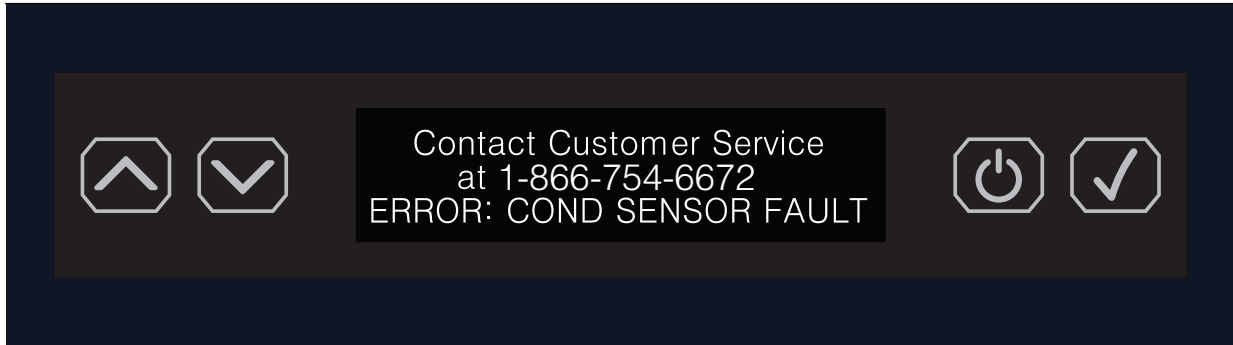

WATER SHORTAGE ALARM: WATER FAULT is displayed as an ERROR CODE.

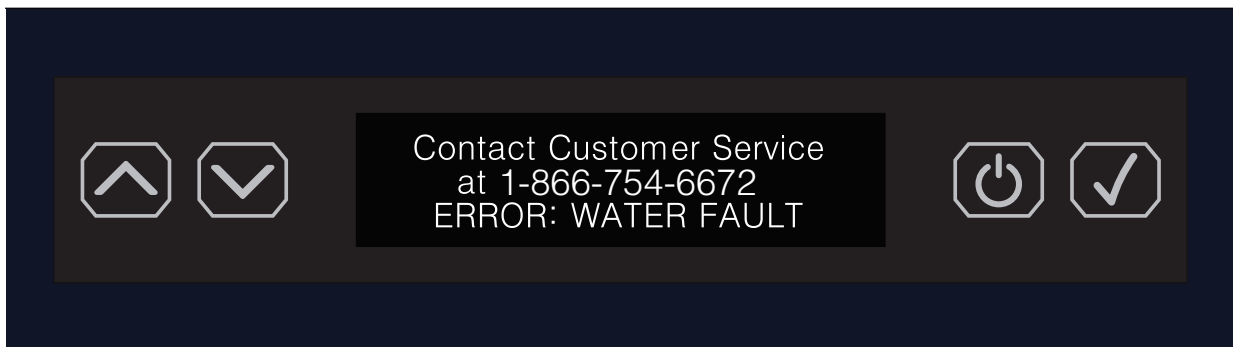

DRAINAGE FAULT ALARM: DRAINAGE FAULT is displayed as an ERROR CODE.

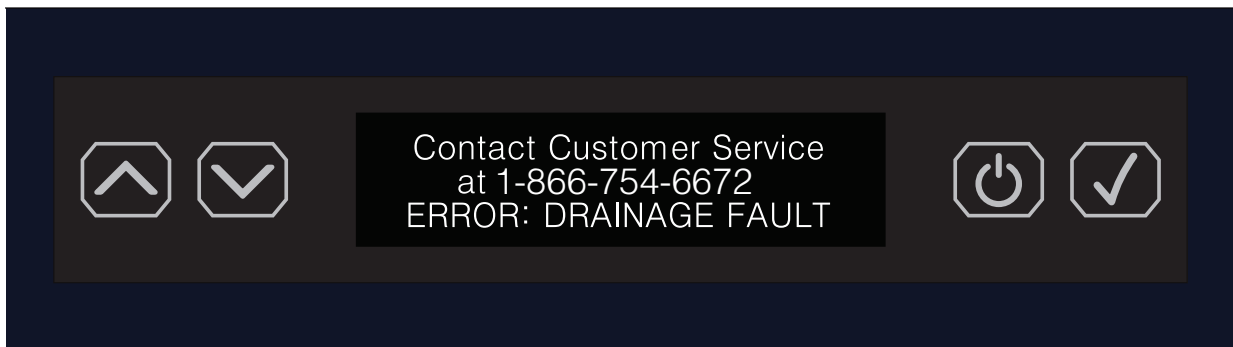

BIN SENSOR FAULT ALARM: BIN SENSOR FAULT is displayed as an ERROR CODE.
(Only for Ice Shot Glass Models)

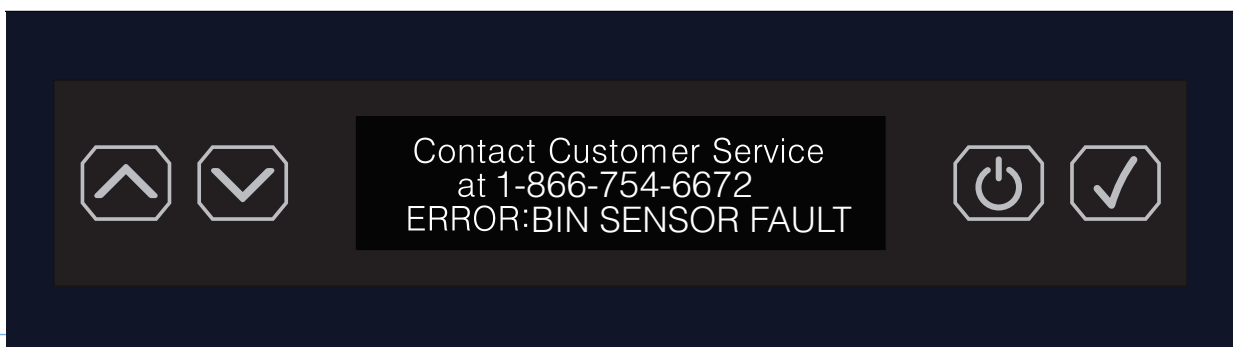

EXPECTING NORMAL SOUNDS

Your new ice machine may make sounds that are not familiar to you. Hard surfaces like the floor and walls can make the sounds seem louder than they actually are. The following describes the kinds of sounds that might be new to you and the source of those sounds:

- Rattling noises may come from the flow of the refrigerant or the water line. Items stored on top of the ice machine can also make noises.
- The high-efficiency compressor may make a pulsating or high-pitched sound.
- Water running from the evaporator to the water reservoir may make a splashing sound.
- As each cycle ends, you may hear a gurgling sound due to the refrigerant flowing in your ice machine.
- You may hear the sound of the condenser fan forcing air over the condenser.
- During the harvest cycle, you may hear the sound of ice cubes falling into the ice bin.

DEALING WITH POWER FAILURE

Most power failures are corrected within a few hours and should not affect the temperature of your ice machine if you minimize the number of times you open the ice machine door. If the power is going to be off for a longer period of time, take the proper steps to disconnect your appliance.

WARNING

Failure to unplug the ice machine could result in electrical shock or personal injury.

NOTE: When the ice machine is operating, the evaporator is only component that is cold to make ice. A power failure will only impact the machine making ice. The ice in the bin would slowly melt as normal.

5

CARE AND MAINTENANCE

WARNING

Electrical Shock Hazard

Always disconnect power at the source before working on the unit. Failure to unplug the clear ice machine could result in electrical shock or personal injury.

- Do not touch the power plug when your hands are wet.
- Never unplug the unit by pulling on the cord. Grasp the plug and pull out firmly.

REPLACING WATER FILTER - INDOOR ICE MACHINES

Indoor ice machines feature a water filter that requires replacement when the filter indicator on the control panel is lit. To replace the water filter:

1. Rotate the water filter cover 90 degrees counterclockwise. Remove the cover.



2. Grasp the base of the water filter. Rotate the filter counterclockwise until it feels loose.



3. Pull the water filter out of the machine.
4. Using a new water filter, insert the filter into the machine aligning tabs on the filter with slots in the water filter head.



5. Rotate the water filter clockwise until it locks into place.
6. Install the water filter cover by rotating the cover 90 degrees clockwise.

CLEANING AND MAINTAINING THE UNIT

Perform periodic cleaning and proper maintenance to ensure efficiency, top performance, and long life. The maintenance intervals listed in this manual are based on normal conditions. You may want to shorten the intervals if you have pets or if you have other special considerations.

- Periodically vacuum dust and dirt from the condenser, which is located behind the grill at the bottom front of the unit.
- Regularly inspect plumbing connections to ensure that no leaks exist.
- Disconnect the water supply hose if the ice machine will not be used for a long period of time.
- Never keep anything in the ice storage bin that is not ice. Objects such as wine and beer bottles are not sanitary.

CLEANING THE UNIT'S EXTERIOR

Clean the door and cabinet with a mild detergent and warm-water solution, such as 1oz. (28 g) of dish-washing liquid mixed with 2 gallons of warm water. Do not use solvent-based or abrasive cleaners. Use a soft sponge and rinse the unit with clean water. Wipe the unit with a soft, clean towel to prevent water spotting.

Clean stainless steel with a mild detergent, a warm-water solution and a damp cloth. Never use an abrasive cleaning agent.

CLEANING THE UNIT'S INTERIOR

When necessary, defrost and thoroughly clean the inside of the unit with mild soap and water. Do not use electrical heating devices or sharp or pointed tools when defrosting the unit.

When defrosting or leaving the unit turned off, leave the door open. Leaving the door open allows air to dry the inside of the cabinet, reducing the chance for mildew and damage to the mold mechanism's components.

EXTENDED PERIODS OF NON-USE

WARNING

Electrical Shock Hazard

Always disconnect power at the source before working on the unit.

NOTE: Do not winterize this unit with ANY type of anti-freeze; damage to the mold coating will occur, invalidating product's Limited Warranty and creating potential health hazard.

1. Turn off the water at the main water source.
2. Disconnect the water supply line from the water inlet of the ice machine.
3. Turn off the electric supply at the main power source. Remove the power cord from the electrical outlet.
4. Remove any remaining ice from the storage bin.
5. Press and hold the UP and DOWN buttons together for at least 3 seconds to open the drain valve, or enter the service menu to open the drain valve and then drain all water in the water trough. Press and hold the UP and DOWN buttons together for at least 3 seconds again or turn the unit off to close the drain valve.
6. Leave the door open to allow for circulation and prevent mold and mildew.
7. Leave the water supply line disconnected and the power cord unplugged until ready to use.

NOTICE

Never pull on the power cord to unplug the appliance from the electrical outlet. Grasp the plug of the power cord and pull out firmly.

RECOMMISSIONING THE UNIT

1. Connect the water supply lines, turn on the water, check for leaks, and then restore power to the unit.
2. Once water has filled the trough, ice making cycles will commence.

STARTING UP THE UNIT

1. Turn on the water, check for leaks, and then turn on power.
2. Turn on the unit by pressing the power button.
3. The water supply valve will turn on immediately to supply water to the unit. The water pump and compressor will turn on later (approximately 5 minutes) to initiate the ice making cycle. If the machine was shut-off while in the ice-harvesting cycle, make sure the ice is harvested before starting up the unit.
4. The first harvest of ice should occur within 60 minutes of start-up.
5. After the unit purges air from the lines, normal harvesting and refilling occur every 40 minutes or less, under normal conditions.

CLEANING THE CONDENSER

WARNING

Electrical Shock Hazard

Always disconnect the power at the source before working on the unit.

CAUTION

Sharp Object Hazard

DO NOT touch the condenser surface. The condenser has sharp edges and can be easily damaged.

A dirty or clogged condenser prevents proper airflow, reduces ice-making capacity, and causes higher-than-recommended operating temperatures that may lead to component failure. Clean the condenser or have it cleaned at least once every six months.

1. Unplug the appliance or disconnect power.
2. Remove the two screws under the front of the unit. Gently pull on the grill and remove it.
3. Remove dirt and lint from the condenser and the unit compartment with the brush attachment of a vacuum cleaner.
4. Position the grill on the unit and secure it with the two screws.
5. Plug in the ice machine or reconnect power.

6

TROUBLESHOOTING

PROBLEM	POSSIBLE CAUSES	SOLUTIONS
<ul style="list-style-type: none"> The machine won't operate. 	<ul style="list-style-type: none"> The ice machine is unplugged. The ice machine power switch is OFF. The ice storage bin is full of ice. 	<ul style="list-style-type: none"> Plug the ice machine in. Verify that the control unit is properly programmed. Take away some ice cubes; make sure the "ice full" probe is free of ice.
<ul style="list-style-type: none"> The compressor works abnormally with a buzzing noise. 	<ul style="list-style-type: none"> The voltage is lower than recommended. 	<ul style="list-style-type: none"> Stop the ice machine and do not restart until the voltage is normal.
<ul style="list-style-type: none"> The water doesn't feed in after the ice machine starts. 	<ul style="list-style-type: none"> The water supply tap is turned off. The water supply pipe is not properly connected. The water filter is not installed or not installed correctly. 	<ul style="list-style-type: none"> Turn on the water supply tap. Reconnect the water supply pipe. Check that the water filter is installed correctly.
<ul style="list-style-type: none"> Machine makes ice, but bin does not fill up with ice. 	<ul style="list-style-type: none"> The condenser may be dirty. The airflow to the ice machine may be obstructed. The ambient temperature and water temperature are high, or it is near with some heat source. 	<ul style="list-style-type: none"> Clean the condenser. Check the installation. Run the unit for a longer period of time.
<ul style="list-style-type: none"> Water is leaking out of the unit. 	<ul style="list-style-type: none"> A few water droplets are on the door. The water supply connection is leaking. 	<ul style="list-style-type: none"> Under some conditions, humidity may condense on the door. Consider moving the unit or just be more careful when you open the door. Tighten water supply hose fitting.
<ul style="list-style-type: none"> Cubes are partially formed and are white at the bottom. 	<ul style="list-style-type: none"> There is not enough water in the water bin. 	<ul style="list-style-type: none"> Check if the water supply pressure is below 15 psi. Check the water supply. It may be restricted. Check for a water leak at the water trough.

PROBLEM	POSSIBLE CAUSES	SOLUTIONS
<ul style="list-style-type: none"> Noise during operation. 	<ul style="list-style-type: none"> The feet are not leveled. Certain sounds are normal. 	<ul style="list-style-type: none"> Level the feet. See “Leveling the Unit” on page 13. See “Expecting Normal Sounds” on page 52.
<ul style="list-style-type: none"> The ice made is too large and has pieces sticking together. 	<ul style="list-style-type: none"> The water temperature in the storage tray or ambient is too low. 	<ul style="list-style-type: none"> Stop the machine and reset the ice-making cycle. Restart the machine after turning it off.
<ul style="list-style-type: none"> Conditions for ice-making cycle are right but no ice is made. 	<ul style="list-style-type: none"> The refrigerant leaks and/or the sealed system is blocked. Water pressure is not properly set. 	<ul style="list-style-type: none"> Contact Sapphire Service Department. The recommended water pressure is 58 psi. Pressures must not fall below 15 psi and static pressure must not exceed 80 psi.
<ul style="list-style-type: none"> The ice machine stops suddenly while making ice. 	<ul style="list-style-type: none"> The electricity is off. The room temperature is out of the stated range. 	<ul style="list-style-type: none"> Reconnect the power supply line. Cut off the electricity and let the ice machine stop working until the temperature returns within the stated range.
<ul style="list-style-type: none"> The body of the ice machine is electrified. 	<ul style="list-style-type: none"> The ground line is not in the sockets. 	<ul style="list-style-type: none"> Use the correct plug and outlet.
<ul style="list-style-type: none"> Scale builds up quickly inside the machine. 	<ul style="list-style-type: none"> The calcium level in the water is too high. 	<ul style="list-style-type: none"> Use a water-softening apparatus installed in front of the water inlet valve.

7

DISPOSING THE UNIT

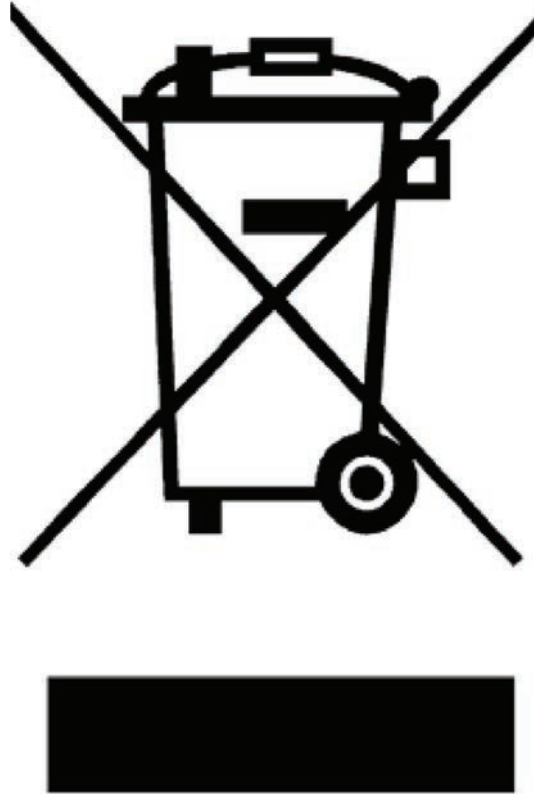

This symbol on the product or its packaging indicates that you cannot treat this product as normal domestic trash; you must hand it in to a collection point for recycling electric and electronic appliances. Your contribution to the correct disposal of this product protects the environment.

Contact your local municipal authority if you need more information about recycling this product.

DANGER

Always remove the door and keep the shelves in place when discarding this appliance so children may not become entrapped.

WARRANTY

LIMITED WARRANTY COVERAGE

The Legacy Companies, warrants to the original purchaser of its SAPPHIRE products that they will be free from defects in materials and workmanship for the following time periods from the date of purchase shown on the sales receipt:

Two (2) year Parts & On-site Labor

Five (5) years Compressor Warranty (Parts only)

WARRANTY EXCLUSIONS

NO CONSEQUENTIAL DAMAGES: SAPPHIRE and The Legacy Companies are not responsible for any economic loss or special, indirect or consequential damages including without limitation; loss of revenue and loss or damage arising from food or product spoilage claims.

WARRANTY IS NOT TRANSFERABLE: This warranty is not transferable or assignable and applies only to the original verified purchaser.

NO IMPLIED WARRANTY OF MERCHANTABILITY OR FITNESS FOR PARTICULAR SERVICE: There are no other warranties statutory, express, or implied. This Limited Warranty is the exclusive warranty and made in lieu of all other warranties including any implied warranties or any warranties of merchantability or fitness for a particular purpose.

FILING WARRANTY CLAIMS: All warranty claims for SAPPHIRE products must be made directly through The Legacy Company's Technical Service Department. All claims should include: model and serial number, proof of purchase, date of installation, location purchased, and all pertinent information supporting the existence of the claim.

IMPROPER ELECTRICAL AND WATER CONNECTIONS: SAPPHIRE and The Legacy Companies are not responsible for the repair or replacement of any failed or damaged components resulting from electrical power failure, the use of extension cords, low voltage or voltage spikes to the unit. Likewise, repair or replacement attributable to low water pressure, high water pressure or contaminated water are not covered by this Limited Warranty.

IMPROPER USAGE: Neither SAPPHIRE nor The Legacy Companies assumes liability for parts or labor coverage for component failure or other damages resulting from improper usage or installation or failure to clean and/or maintain the product as set forth in the Owner's Manual provided with each unit.

CONSUMABLES: This warranty does not include consumable parts such as water filters and light bulbs.

ADJUSTMENTS & CALIBRATIONS: Adjustments including calibrations, leveling, tightening of fasteners, or utility connections normally associated with the original installation are the responsibility of the dealer, installer or the end user and not the responsibility of SAPPHIRE or The Legacy Companies and will not be considered warranty issues for this Limited Warranty.

CONSEQUENTIAL DAMAGES: This warranty does not cover any defect due to, or resulting from, ordinary wear and tear, handling, abuse, misuse, or harsh chemical action, nor shall it extend to any product from which the serial number has been removed or altered, or modifications made by unauthorized service personnel or damage by flood, fire, earthquake or other Acts of God.

OUTSIDE U.S. & CANADA: This warranty does not apply to, and SAPPHIRE and The Legacy Companies are not responsible for any warranty claims made on products sold or used outside of the United States and Canada or any territories of the United States of America.

ALL REPAIRS AND SERVICE MUST BE MADE BY A SAPPHIRE AUTHORIZED TECHNICIAN.

Customer Service: 1.866.754.6672
SAPPHIRE Appliances | The Legacy Companies
3355 Enterprise Avenue, Suite 160, Fort Lauderdale, FL 33331
email@sapphireappliances.com | SapphireAppliances.com



SAPPHIRE

SapphireAppliances.com | 866.754.6672
SAPPHIRE Appliances | The Legacy Companies
3355 Enterprise Avenue, Suite 160, Weston, FL 33331