

INSTALLATION INSTRUCTIONS

CARE AND USE MANUAL FOR:

UNDER CABINET RANGE HOODS

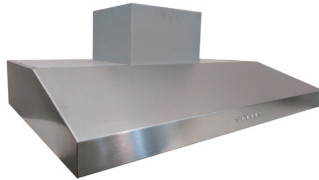

Models covered by this instructions:

SUF6

*** BEFORE INSTALLATION ***

ENSURE THERE IS NO VISIBLE OR HIDDEN DAMAGE SUSTAINED DURING SHIPPING

*** SHIPPING DAMAGE ***

MUST BE REPORTED WITHIN 5 DAYS OF RECEIPT



Sirius

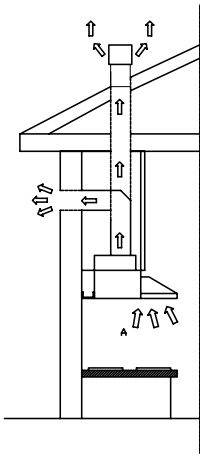

1

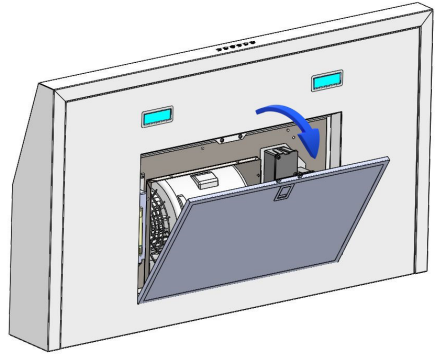

2

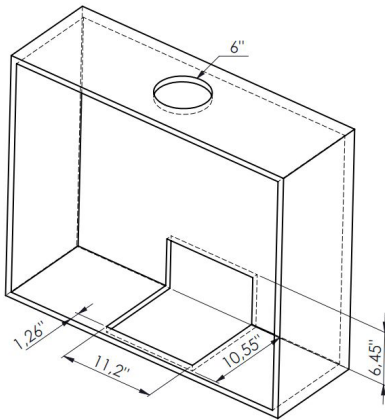

3

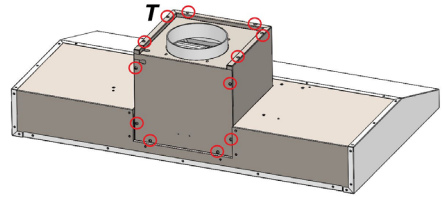

4

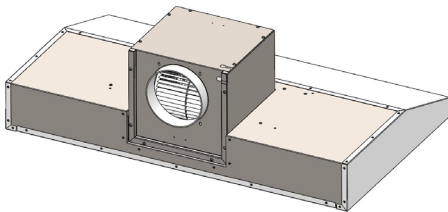

5

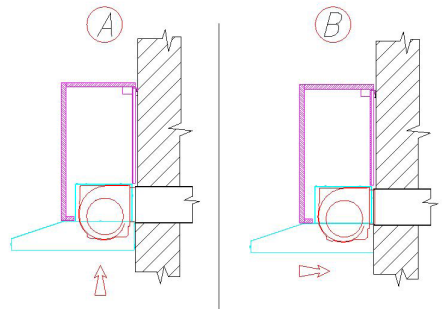

6

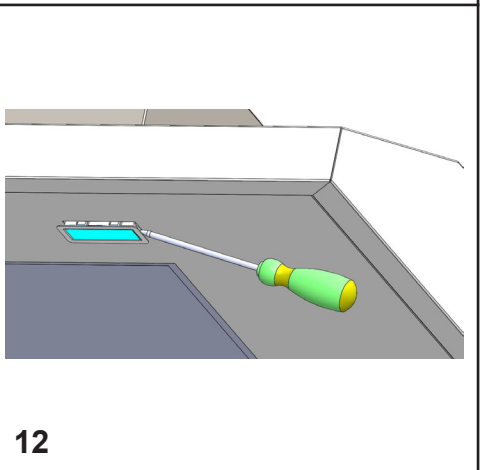
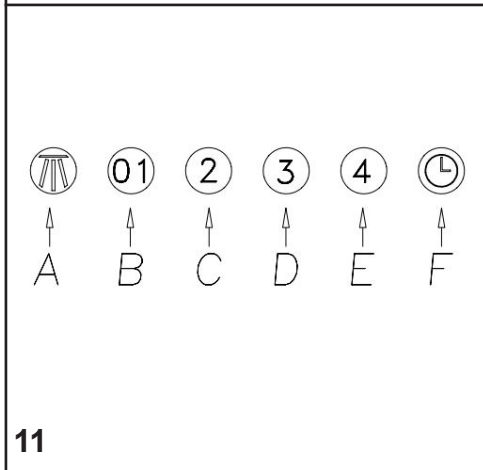
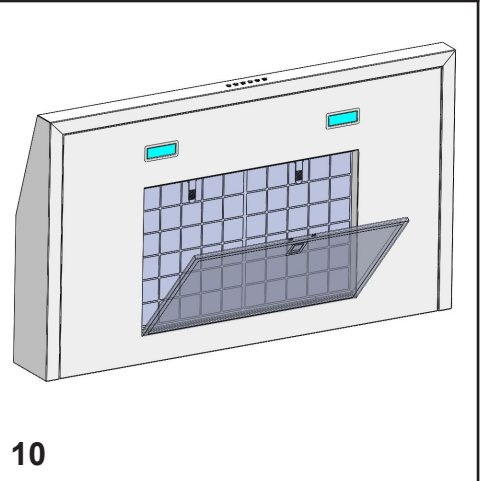
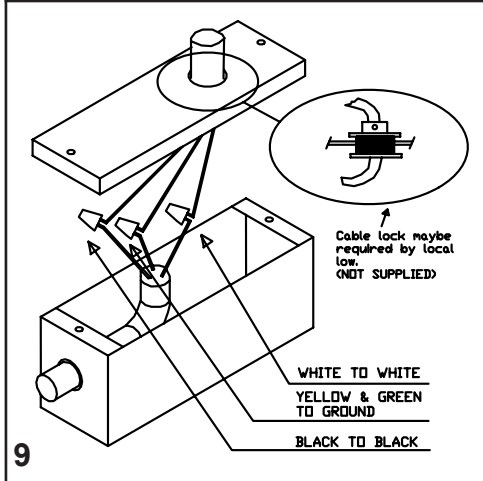
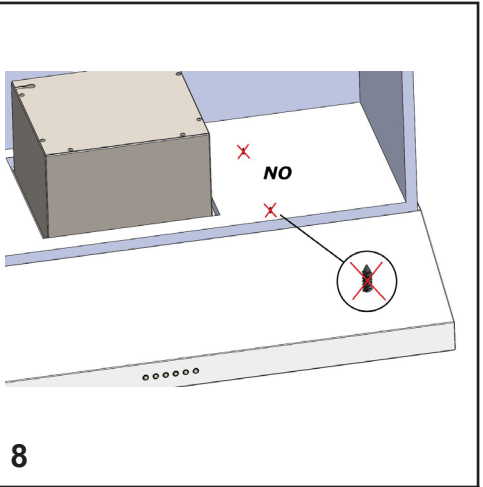
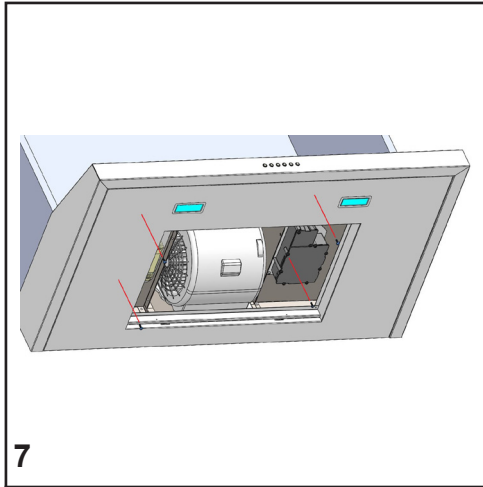

WARNING

*Thank you for purchasing a Sirius Range Hood.
Please read all the instructions in this manual before installing the appliance.*

Save these instructions for future reference.

Only use this appliance as an exhaust ventilation system for the removal of cooking vapors. **DO NOT** use to expel flammable substances or any other materials or vapors.

The installation procedures in this manual are intended for qualified installers, service technicians or persons with similar qualified background. **DO NOT** attempt to install this appliance yourself.

Ensure that electrical power is turned off at source before commencing installation. All electrical wiring must be properly installed, insulated and grounded and conform to all applicable codes and standards.

Make sure all existing duct work is clean of grease build up, or duct work should be replaced, if necessary, to avoid the possibility of a grease fire. Check all joints on ductwork to ensure proper connection and all joints should be properly taped. Be careful when cutting through ceilings or walls not to damage any hidden pipes or electrical wiring. Ensure your kitchen has sufficient air return vents to replace the exhausted air.

The minimum distance between the cooker surface and the inferior part of the cooker hood must be of 650 mm.

Fan ducts should always be vented to the outside of your home and never into spaces within walls, ceilings, lofts or attics. Only use rigid, smooth steel for ducting. The exhaust point of the blower requires a 6" round connection.

TABLE OF CONTENTS

BEFORE YOU BEGIN	6
DUCTING	6
External Venting Requirements	6
Duct Run Calculation	7
ELECTRICAL	7
Electrical Supply	7
INSTALLATION	8
Connecting Electricity and Ducting	8
Re-Circulating Requirements	8
OPERATING PROCEDURES	9
General Advice	9
Functions	9
MAINTENANCE	10
Cleaning the Filter	10
Cleaning the Hood	10
Replace led lamp	10
WARRANTY	11

BEFORE YOU BEGIN

The manufacturer declines all responsibility in the event of failure to observe the instructions given here for installation, maintenance and suitable operation of the product. The manufacturer further declines all responsibility for injury due to negligence and the warranty of the unit automatically expires due to improper maintenance and/or installation.

BEFORE YOU BEGIN: It is advisable to test run the range hood before installation.

BEFORE STARTING – please read this entire document and ensure you are fully conversant with the requirements and limitations. These units weigh approximately 125lbs and therefore require a minimum of two people to install.

DUCTING

(Not applicable if the range hood is used in re-circulating model).

WARNING: Do not vent this appliance into any other ductwork, spaces between walls, ceilings, attics, garages or any other confined space.

External Venting Requirements.

When planning new ductwork, always look for the most direct route to the outside. Venting can be done through the roof or directly through the back outside wall. (See Figure 1).

Only use rigid type metal ducting (plastic ducting is generally not permitted by code). Flexible ducting could restrict airflow by up to 50%. Always fasten connections with sheet metal screws and tape all joints with certified Silver Tape or Duct Tape.

Do not use screws to fasten ductwork to the hood, only use tape as the screws will stop the dampers from opening and your hood will not work. This hood requires a 6" round duct outlet. You can increase the duct size of the duct run but never decrease it. Use the shortest and most direct route possible.

Always, wherever reduce the number of transitions and turns with as few sharp angles as possible.

Two staggered 45 degree angles are better than one 90 degree. Make these turns as far away from the motor exhaust as possible, with as much space between each bend.

Duct Run Calculation

The maximum duct run before effecting the performance of the hood is 100'. Calculate your duct run by measuring linear feet and adding the elbows, transitions and caps based on the table alongside.

Maximum Run	
6" or 3 1/4 x 10" duct	100 FT
Deduct	
Each 90 elbow used	15FT
Each 45 elbow used	9FT
Each 6" or 3 1/4 x 10" duct	
Transition used	1FT
Each 3'1/4 x 10" to 6"	
Transition used	5FT
Side Wall with damper	30FT
Roof Cap	30FT

The ducting connection to the hood must be in line with the central vertical axis of the range hood 1" away from the back wall on which the hood is to be mounted. Range hoods may interrupt the proper flow of combustion gases from fireplaces, gas furnaces and gas water heaters. To minimize the risk of drawing these lethal gases back into the home, please follow the heating equipment manufacturers safety standards and guidelines carefully.

Refer to NFPA and ASHRAE for additional information.

ELECTRICAL

WARNING: All electrical work must be performed by a qualified electrician.

Please ensure that the appropriate electrical codes or prevailing local building codes and ordinances are adhered to.

Ensure that the electricity supply is disconnected at source. Do not use an extension cord or adapter plug with this appliance.

This appliance must be grounded. Connect to a properly grounded branch circuit, protected by a 15 amp circuit breaker.

Electrical Supply.

This range hood requires a 120V, 60Hz supply and draws a maximum of 3 amps. The electrical supply to the range hood should be at least 17" from the underside of the installed range hood.

For a typical installation, where the underside of the range hood will be 30" above the counter top and the counter top is 36" above the floor level, the electrical supply should be 76" above floor level and no further than 3" to the right (as you face the wall) of the central axis of the range hood.

INSTALLATION - SUF6

Before installing the appliance, in order not to damage the appliance itself, the metal grease filter should be removed by pushing the special filter handle toward the back side of the cooker hood and turning it downwards so to unfasten it from its slot (refer to figure 2).

Make a cut-out on the bottom of the cabinet to hold the appliance by using the drilling jig provided. This opening must be 10,55" x 11,2" x 6,45" and at a distance of 1,26" from the front edge of the cabinet (refer to figure 3).

The hoods can be installed with the air outlet venting upwards or backwards.

In upwards venting applications make a round cut-out on the upper part of the cabinet measuring Ø6" as figure 3.

In backwards venting applications turn the motor assembly box as shown in figure 4 - 5 by unscrewing the screws "T" and turning the motor assembly box having the air outlet venting backwards.

Fix it with the screws previously removed. Insert the built-in unit in the hole made in the cabinet (refer figure 3).

The air outlet pipe, in the case of a fan oriented towards the rear of the product, must be flush with the surface on which the lower part of the hood will come into contact (refer figure 6).

Install the appliance with appropriate screws, according to the thickness of the board. The base of the cabinet must be from 0.4" to 1" thick (refer to figure 7-8).

Connecting Electricity and Ducting.

Please refer to the Electrical Supply section on page 2 for the required location of the electrical supply.

CAUTION: Make sure the power is turned off at source. Make electrical connections (refer to Figure 9).

Ensure that the plastic flaps at the exhaust outlet for the fan move freely and have not become jammed or stuck.

Connect the appropriate length of ducting to the fan exhaust point and join up with the ducting to the exterior.

Do not fix the ducting to the range hood exhaust outlet with screws-use duct tape. Use duct tape on all joints.

Re-Circulating Requirements.

If the unit is to be used in the re-circulating mode, fit the carbon filter after the installation is complete (refer to Figure 10).

The carbon filter fits in behind the aluminium grease filter. Ensure that the plastic tabs on the carbon filter are facing outwards otherwise it will be difficult to remove it later for replacement.

A short length of ductwork must be connected from the exhaust outlet on the fan to wherever the air is to be exhausted. Allow sufficient space to connect the ductwork to the top of the exhaust outlet on the fan housing. Do not fix the ducting to the range hood exhaust outlet with screws, use duct tape. Duct tape should be used on all joints.

OPERATING PROCEDURES

Read all the instructions before operating the appliance. Save these instructions for future reference.

General Advice.

Ensure that the grease filters are in place. Without these components, operating blowers could catch on to hair, fingers and loose clothing. Keep fan, filters and surfaces clean of grease and fat. Always turn hood fan ON when cooking. NEVER leave cooking unattended.

NEVER dispose cigarette ashes, ignitable substances or any foreign objects into blowers.

Cooking that generates flame is not recommended as this hood is equipped with a thermal overload that will shut down the motor if it senses excessive heat. When frying, oil in the pan can easily overheat and ignite. Heat oil slowly in an appropriately sized pot (covering the entire burner) to reduce the risk of boiling over and burning.

In the event of a range top grease fire, observe the following:

Switch OFF the range hood. Turn off the cook top then smother flames with a close fitting lid, cookie sheet or other metal tray. If the flames do not go out immediately.

EVACUATE AND CALL THE FIRE DEPARTMENT.

Never pick up a flaming pan – you may be burned. DO NOT USE WATER including wet dishcloths or towels, as a violent steam explosion may occur.

FUNCTION

SUF6 (Fig.11)

- A: Light ON/OFF button
- B: Blower Speed 1 (low) or OFF
- C: Blower Speed 2 (medium)
- D: Blower Speed 3 (high)
- E: Blower Speed 4 (intensive)
- F: 10 Minute Timer

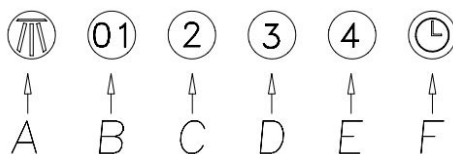

fig. 11

Generally, the grease filter should be washed on a regular basis to avoid grease filter fires.

The blower should be turned on for approximately 5 minutes before cooking in order to establish air currents upward through the hood. Use the low speeds for normal use and the higher speeds for strong odors and fumes.

MAINTENANCE

The range hood should provide many years of trouble free use provided it is properly maintained. Be sure the lights are cool before cleaning the hood – they are halogen and become extremely hot.

Cleaning the Filter.

The aluminium mesh filters should be washed by hand or in the dishwasher as required. Damaged and worn filters must be replaced immediately. (Do not operate blower when filters have been removed). Allow filters to dry before replacing them, otherwise water will be drawn into the blower.

If a carbon filter has been fitted, this must be replaced every 6 months as a minimum, depending on usage and type of cooking that is performed.

It is suggested that a spare set of carbon filters is kept on hand. These can be ordered from the supplier of your range hood.

Cleaning the Hood.

The outside and interior of your hood should be wiped regularly with a clean, damp cloth and mild household dish detergent or degreaser.

Use a good quality non-abrasive foaming type stainless steel cleaner for exterior surfaces.

Follow the manufacturers directions. Generally the foam is sprayed onto a clean dry cloth and then applied to the stainless steel. Allow the foam to react on the surface for a few minutes and then wipe with a clean dry cloth.

On the surfaces that are exposed directly to heat from the cook-top, it is advisable to clean these regularly to avoid the deposits from becoming baked on.

Do not use abrasive cleaning agents as these will destroy the brushed finish.

Replace the led lamp SUF6

Before replacing the led lamp switch off the appliance using appropriate tools and then remove the led lamp from its slot (Fig. 12).

Take out the led lamp from its connector and replace it with another one with similar characteristics.

To find the correct led lamp please check on the replacement part list.

If the supply cord is damaged, it must be replaced by the manufacturer or its service agent or a similarly qualified person in order to avoid a hazard.



Three Year Limited Warranty

YOU MUST REGISTER THE PURCHASE OF YOUR PRODUCT ON LINE AT www.siriuscappe.com/usa/warranty.htm TO CONVALIDATE YOUR WARRANTY.

YOU CAN FIND THE DATA OF YOUR HOODS ON A LABEL INSIDE THE HOOD. JUST REMOVE THE GREASE FILTER TO READ IT.

WARRANTY SERVICE

To qualify for warranty service, you must notify Sirius After sale service at the email address stated below or call toll free USA 1-877-474-8770 and provide the model number, description of the fault or defect and original date of purchase. Sirius reserves the right to request proof of original purchase. Sirius will at its sole option and discretion replace products that arrive damaged through shipping, provided shipping damage is reported as stated above **WITHIN 5 BUSINESS DAYS OF RECEIPT** of the shipped product or products.

ONE YEAR SERVICE REPAIR WARRANTY:

During the first year from date of original purchase, Sirius will, at its option, repair or replace, without charge, any product or part which is found to be defective under normal use and service.

THREE YEAR PARTS WARRANTY:

For three years from date of purchase, Sirius will provide free of charge, non-consumable replacement parts which are found to be defective under normal use and service.

WHO IS COVERED:

Sirius warrants to the original consumer purchaser of its products that such products will be free from defects in materials and workmanship for a period of three years from the original date of purchase. There are no other warranties, express or implied, including, but not limited to, implied warranties of merchantability or fitness for a particular purpose or application.

WHAT IS NOT COVERED:

This warranty does not extend to filters, lamps, batteries, ducts and ductwork components. This warranty does not cover normal maintenance and service or products or parts which have been subject to misuse, negligence, accident, improper maintenance or repair, faulty installation or installation contrary to recommended installation instructions. The warranty on glass screens is limited to manufacturing defects only and expressly excludes cracks and breakages as a result of faulty installation. *Labor and associated costs associated directly with removal and re-installation are expressly excluded.*

The duration of any implied warranty is limited to the three year period as specified for the express warranty. Some states and provinces do not allow limitation on how long an implied warranty lasts, so the above limitation may not apply to you.

Sirius S.P.A.

Zona industriale Berbentina 6/A
60041 SASSOFERRATO (AN)
ITALY

Sirius after sale service

Telephone (toll free): 1-877-474-8770
Email: Sirius@adcoservice.com