

Microwave Oven

use & care

Introduction 2
Precautions Microwave Energy 3
Important Safety Instructions 4-7
Names Of Oven Parts And Accessories 8
Operation 9-19
Maintenance 20

Cleaning And Care 21-23
Service Call Check 24
Warranty 25

2

INTRODUCTION

Welcome to our *family*

Thank you for bringing Frigidaire into your home! We see your purchase as the beginning of a long relationship together.

This manual is your resource for the use and care of your product. Please read it before using your appliance. Keep it handy for quick reference. If something doesn't seem right, the troubleshooting section will help you with common issues.

FAQs, helpful tips and videos, cleaning products, and kitchen and home accessories are available at www.frigidaire.com.

We are here for you! Visit our website, chat with an agent, or call us if you need help. We may be able to help you avoid a service visit. If you do need service, we can get that started for you.

Let's make it official! Be sure to register your product.

Keep your product info here so it's easy to find.

Model Number: _____

Serial Number: _____

Purchase Date: _____

Let's make it official! Be sure to register your product.

Visit us at Frigidaire.com/register

Or use your mobile device to scan the QR code.

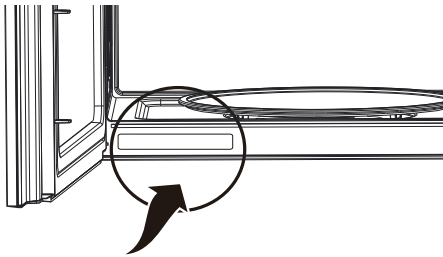

Serial Number Location

PRECAUTIONS TO AVOID POSSIBLE EXPOSURE TO EXCESSIVE MICROWAVE ENERGY

Do not attempt to operate this oven with the door open since open door operation can result in harmful exposure to microwave energy. It is important not to defeat or tamper with the safety interlocks.

Do not place any object between the oven front face and the door or allow soil or cleaner residue to accumulate on sealing surfaces.

WARNING

To reduce the risk of burns, electric shock, fire, injury to persons or exposure to excessive microwave energy:

Do not operate the oven if it is damaged. It is particularly important that the oven door close properly and that there is no damage to the:

- (1) DOOR (bent)
- (2) HINGES AND LATCHES (broken or loosened)
- (3) DOOR SEALS AND SEALING SURFACES.

The oven should not be adjusted or repaired by anyone except properly qualified service personnel.

This device complies with part 18 of the FCC Rules. (Only for USA)

RADIO INTERFERENCE

- Operation of the microwave oven may cause interference to your radio, TV or similar equipment.
- When there is interference, it may be reduced or eliminated by taking the following measures:
 - Clean door and sealing surface of the oven.
 - Reorient the receiving antenna of radio or television.
 - Relocate the microwave oven with respect to the receiver.
 - Move the microwave oven away from the receiver.
 - Plug the microwave oven into a different outlet so that microwave oven and receiver are on different branch circuits.

UTENSILS

CAUTION

- Personal Injury Hazard

- Tightly-closed utensils could explode. Closed containers should be opened and plastic pouches should be pierced before cooking.
- See the instructions on "Materials you can use in microwave oven or to be avoided in microwave oven."
There may be certain non-metallic utensils that are not safe to use for microwaving. If in doubt, you can test the utensil in question following the procedure below.

Utensil Test:

- Fill a microwave-safe container with 1 cup of cold water (250ml) along with the utensil in question.
- Cook on maximum power for 1 minute. Carefully feel the utensil. If the empty utensil is warm, do not use it for microwave cooking.
- Do not exceed 1 minute cooking time.

SAVE THESE INSTRUCTIONS

4 IMPORTANT SAFETY INSTRUCTIONS

Read all instructions before using this appliance.

This manual contains important safety symbols and instructions. Please pay attention to these symbols and follow all instructions given.

Do not attempt to install or operate your appliance until you have read the safety precautions in this manual. Safety items throughout this manual are labeled with a WARNING or CAUTION statement based on the risk type.

Warnings and important instructions appearing in this guide are not meant to cover all possible conditions and situations that may occur. Common sense, caution, and care must be exercised with installing, maintaining, or operating your appliance.

DEFINITIONS

 This is the safety alert symbol. It is used to alert of potential personal injury hazards. Obey all safety messages that follow this symbol to avoid possible injury or death.

WARNING

Indicates a potentially hazardous situation which, if not avoided, may result in death or serious injury.

CAUTION

Indicates a potentially hazardous situation which, if not avoided, may result in minor or moderate injury.

NOTE

Indicates a short, informal reference - something written down to assist the memory or for future reference.

IMPORTANT

Indicates installation, operation or maintenance information which is important but not hazard-related.

NOTE

ELECTRICAL REQUIREMENTS

Product rating is 120 volts AC, 60 Hertz, 1.5 kilowatts and 13.5 amps. This product must be connected to a separate and dedicated supply circuit of the proper voltage and frequency. Wire size must conform to the requirements of the National Electrical Code or the prevailing local code for this kilowatt rating. The power supply cord and plug should be brought to a separate and dedicated 15- to 20-ampere branch circuit single grounded outlet. The outlet box should be located in the cabinet above the microwave oven. The outlet box and supply circuit should be installed by a qualified electrician and conform to the National Electrical Code or the prevailing local code.

IMPORTANT

1. If you have any questions about the grounding or electrical instructions, consult a qualified electrician or service person.
2. Neither Electrolux nor the dealer can accept any liability for damage to the microwave oven or personal injury resulting from failure to observe the correct electrical connection procedures.

SAVE THESE INSTRUCTIONS

When using electrical appliances basic safety precautions should be followed, including the following:

WARNING

To reduce the risk of burns, electric shock, fire, injury to persons or exposure to excessive microwave energy:

- Read all instructions before using the appliance.
- Read and follow the specific: "PRECAUTIONS TO AVOID POSSIBLE EXPOSURE TO EXCESSIVE MICROWAVE ENERGY" found on page 3.
- This appliance must be grounded. Connect only to properly grounded outlet. See "GROUNDING INSTRUCTIONS" found on page 6.
- Install or locate this appliance only in accordance with the provided installation instructions.
- Some products such as whole eggs and sealed containers - for example, closed glass jars - are able to explode and should not be heated in this oven.
- Use this appliance only for its intended use as described in the manual. Do not use corrosive chemicals or vapors in this appliance. This type of oven is specifically designed to heat, cook or dry food. It is not designed for industrial or laboratory use.
- **HOT CONTENTS CAN CAUSE SEVERE BURNS. DO NOT ALLOW CHILDREN TO USE THE MICROWAVE.** Use caution when removing hot items.
- Do not operate this appliance if it has a damaged cord or plug, if it is not working properly, or if it has been damaged or dropped.
- This appliance should be serviced only by qualified service personnel. Contact nearest authorized service facility for examination, repair, or adjustment.
- Do not cover or block any openings on the appliance.
- Do not store this appliance outdoors. Do not use this product near water - for example, near a kitchen sink, in a wet basement, near a swimming pool, or similar location.
- Do not immerse cord or plug in water.
- Keep cord away from heated surface.
- Do not let cord hang over edge of table or counter. When cleaning surfaces of door and oven that comes together on closing the door, use only mild, nonabrasive soaps, or detergent applied with a sponge or soft cloth.
- To reduce the risk of fire in the oven cavity:
 - Do not overcook food. Carefully attend appliance when paper, plastic, or other combustible materials are placed inside the oven to facilitate cooking.
 - Remove wire twist-ties from paper or plastic bag before when placing bag in oven.
 - If material inside of the oven ignite, keep oven door closed, turn oven off, and disconnect the power cord, or shut off power at the fuse or circuit breaker panel.
 - Do not use the cavity for storage purposes. Do not leave paper products, cooking utensils, or food in the cavity when not in use.
- Liquids, such as water, coffee, or tea are able to be overheated beyond the boiling point without appearing to be boiling. Visible bubbling or boiling when the container is removed from the microwave oven is not always present. **THIS COULD RESULT IN VERY HOT LIQUID SUDDENLY BOILING OVER WHEN THE CONTAINER IS DISTURBED OR A UTENSIL IS INSERTED INTO THE LIQUID.** To reduce the risk of injury to persons:
 - Do not overheat the liquid.
 - Stir the liquid both before and halfway through heating it.
 - Do not use straight-sided containers with narrow necks.
 - After heating, allow the container to stand in the microwave oven for a short time before removing the container.
 - Use extreme care when inserting a spoon or other utensil into the container.
 - Oversized food or oversized metal utensils should not be inserted in a microwave oven as they may create a fire or risk of electric shock. Do not clean with metal scouring pads. Pieces can burn off the pad and touch electrical parts involving a risk of electric shock.
 - Do not store any materials, other than manufacturer's recommended accessories, in this oven when not in use.
 - Do not cover racks or any other part of the oven with metal foil. This will cause over- heating of the oven.
 - Clean Ventilation Hoods Frequently -Grease should not be allowed to accumulate on hood or filter.
 - When flaming foods under the hood, turn the fan on.
 - Use care when cleaning the vent-hood filter. Corrosive cleaning agents, such as lye-based oven cleaners, may damage the filter.
 - Suitable for use above both gas and electric cooking equipment.

SAVE THESE INSTRUCTIONS

6 **IMPORTANT SAFETY INSTRUCTIONS**

GROUNDING INSTRUCTIONS

This appliance must be grounded. In the event of an electrical short circuit, grounding reduces the risk of electric shock by providing an escape wire for the electric current. This appliance is equipped with a cord having a grounding wire with a grounding plug. The plug must be plugged into an outlet that is properly installed and grounded.

WARNING

Improper use of the grounding can result in a risk of electric shock.

Consult a qualified electrician or serviceman if the grounding instructions are not completely understood, or if doubt exists as to whether the appliance is properly grounded. If it is necessary to use an extension cord, use only a 3-wire extension cord that has a 3-blade grounded plug, and 3-slot receptacle that will accept the plug on the appliance. The marked rating of the extension cord shall be equal to or greater than the electrical rating of the appliance.

IMPORTANT

1. If you have any questions about the grounding or electrical instructions, consult a qualified electrician or service person.
2. Neither Electrolux nor the dealer can accept any liability for damage to the microwave oven or personal injury resulting from failure to observe the correct electrical connection procedures.

DANGER

Electric Shock Hazard

Touching some of the internal components can cause serious personal injury or death. Do not disassemble this appliance.

WARNING

Electric Shock Hazard

Improper use of the grounding can result in electric shock. Do not plug into an outlet until appliance is properly installed and grounded.

- A short power supply cord is provided to reduce the risks resulting from becoming entangled in or tripping over a longer cord.
- Longer cord sets or extension cords are available and may be used if care is exercised in their use.
- If a long cord or extension cord is used:
 - The marked electrical rating of the cord set or extension cord should be at least as great as the electrical rating of the appliance.
 - The extension cord must be a grounding-type 3-wire cord.
 - The longer cord should be arranged so that it will not drape over the counter top or tabletop where it can be pulled on by children or tripped over unintentionally.

SAVE THESE INSTRUCTIONS

Materials you can use in microwave oven

Browning dish	Follow manufacturer instructions. The bottom of browning dish must be at least 3/16 inch (5mm) above the turntable. Incorrect usage may cause the turntable to break.
Dinnerware	Microwave-safe only. Follow manufacturer's instructions. Do not use cracked or chipped dishes.
Glass jars	Always remove lid. Use only to heat food until just warm. Most glass jars are not heat resistant and may break.
Glassware	Heat-resistant oven glassware only. Make sure there is no metallic trim. Do not use cracked or chipped dishes.
Oven cooking bags	Follow manufacturer instructions. Do not close with metal tie. Make slits to allow steam to escape.
Paper plates and cups	Use for short term cooking/warming only. Do not leave oven unattended while cooking.
Paper towels	Use to cover food for reheating and absorbing fat. Use with supervision for a short-term cooking only.
Parchment paper	Use as a cover to prevent splattering or a wrap for steaming.
Plastic	Microwave-safe only. Follow the manufacturer instructions. Should be labeled "Microwave Safe". Some plastic containers soften, as the food inside gets hot. "Boiling bags" and tightly closed plastic bags should be slit, pierced or vented as directed by package.
Plastic wrap	Microwave-safe only. Use to cover food during cooking to retain moisture. Do not allow plastic wrap to touch food.
Thermometers	Microwave-safe only (meat and candy thermometers).
Wax paper	Use as a cover to prevent splattering and retain moisture.

Materials to be avoided in microwave oven

Aluminum tray	May cause arcing. Transfer food into microwave-safe dish.
Food carton with metal handle	May cause arcing. Transfer food into microwave-safe dish.
Metal or metal-trimmed utensils	Metal shields the food from microwave energy. Metal trim may cause arcing.
Metal twist ties	May cause arcing and could cause a fire in the oven.
Paper bags	May cause a fire in the oven.
Plastic foam	Plastic foam may melt or contaminate the liquid inside when exposed to high temperature.
Wood	Wood will dry out when used in the microwave oven and may split or crack.

8

NAMES OF OVEN PARTS AND ACCESSORIES

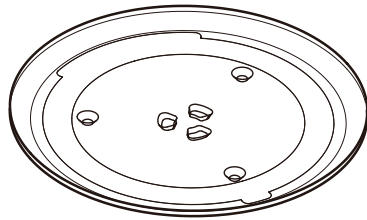
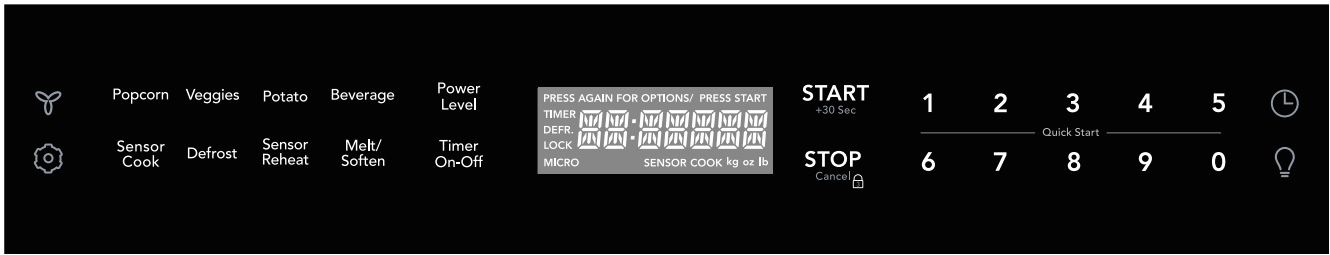

Glass turntable

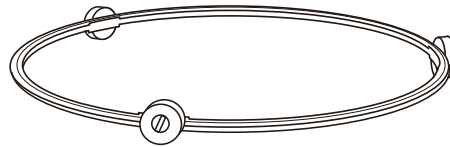



Turntable Ring Assembly

1. Before operating your new oven make sure you read and understand this Use and Care Guide completely.
2. Before the Over the Range Microwave Oven can be used, follow these procedures:
 - Plug in the oven. Close the door. The oven display will show 12:00.
 - If no operation after 1 minute, the oven will show 12:01.
3. Set clock. See below.

TO SET THE CLOCK

- **Suppose you want to enter the correct time of day 12:30 (A.M or P.M.).**

Touch:	Display Shows:
1. 	12:00
2. 	12:30
3. START <small>+30 Sec</small>	12:30

TO SET THE TIMER

- **Set the timer for 3 minutes.**

Touch:	Display Shows:
1. Timer On-Off	ENTER TIME
2. 	3:00
3. Timer On-Off	3:00 <small>Then time will count down</small>

NOTE

1. Opening the door during timer countdown will not pause the running timer.
2. To cancel the active timer, press the Timer On/Off key once.

STOP/CANCEL

Press the STOP/CANCEL to:

1. Erase if you make a mistake during programming.
2. Cancel timer and the signal after cooking.
3. Stop the oven temporarily during cooking.
4. Return the time of day to the display.
5. Cancel a program during cooking, press twice.
6. Press stop/cancel hold 3 seconds to activate or deactivate child-lock function.

USING ONE TOUCH START

This is a time saving pad that will automatically start cooking 2 seconds after selected. Numeric key 1 to 9 can be touched for a 1 minute to 9 minutes automatic start cooking feature.

- **Suppose you want to cook 3 minutes at 100%power.**

Touch:	Display Shows:
1. 	3:00 Time counting down automatically after 2 seconds

NOTE

"Food" will be displayed if a quick start cooking cycle or +30 sec key is not selected within 5 minutes of placing food in the microwave. You must open then close the door again to clear "Food" from the display.

USING ADD 30 SEC.

This is a time-saving pad. It is a simplified feature that lets you quickly set and start microwave cooking at 100% power.

- **Suppose you want to set and start microwave cooking at 100% for 30 SEC.**

Touch:	Display Shows:
1. START <small>+30 Sec</small>	:30 Then time will count down

10 OPERATION

NOTE

1. The cooking time can be extended for 30 seconds by pressing add 30 sec key (only in manual cooking). The cooking time is extended to a maximum of 99 minutes 99 seconds.
2. "Food" will be displayed if a quick start cooking cyc +30 sec key is not selected within 5 minutes of placing food in the microwave. You must open then close the door again to clear "Food" from the display.

SETTING TIMED COOKING WITH POWER LEVEL

This feature lets you program a specific cook time and power. For best results, there are 10 power level settings in addition to HIGH (100%) power. Refer to the "Microwave Power Levels" table.

- **Suppose you want to cook for five minutes at 80% power.**

Touch:	Display Shows:
1. (5) (0) (0)	5:00
2. POWER LEVEL	PL-HI
3. POWER LEVEL	PL-90
4. POWER LEVEL	PL-80
5. START +30 Sec	5:00

Then time will count down

NOTE

If you do not select a power level, the oven will automaticall y cook at HIGH (100%) power.

Potato

- **Suppose you want to cook 1-4 baked potato.**

Touch:	Display Shows:
1. Potato	POTATO
2. START +30 Sec	POTATO

Then time will count down

SETTING TWO-STAGE COOKING

For best results, some recipes call for different power levels during a cook cycle. You can program your oven for two power level stages during the cooking cycle.

- **To set a 2-stage cook cycle. The first stage is a 2 minutes cook time at 30% cook power then a 4 minutes cook time at 70% cook power.**

Touch:	Display Shows:
1. (2) (0) (0)	2:00
2. POWER LEVEL X 8	PL-30
3. (4) (0) (0)	4:00
4. POWER LEVEL X 4	PL-70
5. START +30 Sec	2:00

Then time will count down

MICROWAVE POWER LEVELS

For best results, some recipes call for different cook powers. The lower the cook power, the slower the cooking. Each number from 1 to 9 stands for a different percentage of full cook power.

The following table gives the percentage of cook power each number pad stands for, and the cook power name usually used.

The table also tells you when to use each cook power. Follow recipe or food package instructions if available.

NOTE

Refer to a reliable cookbook for cooking times based on the 1000 Watt cook power of your microwave oven.

COOK POWER	LEVEL	WHEN TO USE IT
100% of full power	100 %	<ul style="list-style-type: none"> Quickly heating convenience foods and foods with high water content, such as soup and beverages. Cooking tender cuts of meat, ground meat or chicken.
9 = 90% of full power		<ul style="list-style-type: none"> Heating cream soups.
8 = 80% of full power		<ul style="list-style-type: none"> Heating rice, pasta, or casseroles.
7 = 70% of full power	Medium-High	<ul style="list-style-type: none"> Cooking and heating foods that need a Cook Power lower than High (for example, whole fish and meat loaf) or when food is cooking too fast. Reheating a single serving of food.

6 = 60% of full power		<ul style="list-style-type: none"> Cooking that requires special care, such as cheese and egg dishes, pudding, and custards. Finishing cooking casseroles.
5 = 50% of full power	Medium	<ul style="list-style-type: none"> Cooking ham, whole poultry, and pot roasts. Simmering stews.
4 = 40% of full power		<ul style="list-style-type: none"> Melting chocolate. Heating pastries.
3 = 30% of full power	Medium-Low, Defrost	<ul style="list-style-type: none"> Manually defrosting pre-cooked and other foods, such as bread, fish, meats and poultry.
2 = 20% of full power		<ul style="list-style-type: none"> Softening butter, cheese, and ice cream.
1 = 10% of full power	Low	<ul style="list-style-type: none"> Keeping food warm. Taking chill out of fruit.
0 = 0% of full power	None	<ul style="list-style-type: none"> Standing time in oven.

USING AUTO DEFROST

Three defrost sequences are preset in the oven. The auto defrost feature provides you with the best defrosting method for frozen foods. The cooking guide will show you which defrost sequence is recommended for the food you are defrosting.

For added convenience, the Auto Defrost includes a built-in beep mechanism that reminds you to check, turn over, separate, or rearrange the food in order to get the best defrost results. Three different defrosting levels are provided:

1. MEAT
2. POULTRY
3. FISH

Available weight is 0.1-6.0 lbs.

12 OPERATION

- Suppose you want to defrost 1.2 lbs of fish.

Touch:	Display Shows:
1. DEFROST	<small>PRESS AGAIN FOR OPTIONS/ PRESS START</small> MEAT
2. DEFROST	<small>PRESS AGAIN FOR OPTIONS/ PRESS START</small> POULTRY
3. DEFROST	<small>PRESS AGAIN FOR OPTIONS/ PRESS START</small> FISH
4. START +30 Sec	ENTER WEIGHT
5. ① and ② To enter weight	<small>PRESS START</small> 1.2
6. START +30 Sec	<small>DEFR.</small> FISH Then time will count down

NOTE

The oven will beep during the DEFROST cycle. At this time, open the door and turn, separate, or rearrange the food. Remove any portions that have thawed. Return frozen portions to the oven and touch START to resume the defrost cycle.

OPERATING TIPS

- For best results, remove fish, shellfish, meat, and poultry from its original closed paper or plastic package (wrapper). Otherwise, the wrap will hold steam and juice close to the foods, which can cause the outer surface of the foods to cook.
- For best results, roll your ground meat into a ball before freezing. During the DEFROST cycle, the microwave will signal when it is time to turn the meat over. Scrape off any excess frost from the meat and continue defrosting.
- Place foods in a shallow containers or on a microwave roasting rack to catch drippings.

This table shows food type selections and the weights you can set for each type. For best results, loosen or remove covering on food.

KEY PRESS	Category	WEIGHTS YOU CAN SET (tenths of a pound)
Defrost	Meat	0.1 to 6.0
Defrost	Poultry	0.1 to 6.0
Defrost	Fish	0.1 to 6.0

Weight conversion table

You are probably used to measuring food in pounds and ounces that are fractions of a pound (for example, 4 ounces equals 1/4 pound). However, in order to enter food weight in Auto Defrost, you must specify pounds and tenths of a pound. If the weight on the food package is in fractions of a pound, you can use the following table to convert the weight to decimals.

Equivalent Weight

OUNCES	DECIMAL WEIGHT
1.6	.10
3.2	.20
4.0	.25 One-Quarter Pound
4.8	.30
6.4	.40
8.0	.50 One-Half Pound
9.6	.60
11.2	.70
12.0	.75 Three-Quarters Pound
12.8	.80
14.4	.90
16.0	1.0 One Pound

NOTE

If between two decimal weights, choose the lower weight for the best defrosting results.

AUTO DEFROST TABLE

NOTE

Meat of irregular shape and large, fatty cuts of meat should have the narrow or fatty areas shielded with foil at the beginning of the defrost sequence.

MEAT SETTINGS

FOOD	SETTING	AT BEEP	SPECIAL INSTRUCTIONS
BEEF			
Ground Beef, Bulk	MEAT	Remove thawed portions with fork. Turn over. Return remainder to oven.	Do not defrost less than 1/4 lb. Freeze in ball shape.
Ground Beef, Patties	MEAT	Separate and rearrange.	Do not defrost less than 2 oz. patties. Depress center when freezing.
Round Steak	MEAT	Turn over. Cover warm areas with aluminum foil.	Place in a microwave safe dish.
Tenderloin Steak	MEAT	Turn over. Cover warm areas with aluminum foil.	Place in a microwave safe dish.
Stew Beef	MEAT	Remove thawed portions with fork. Separate remainder.	Place in a microwave safe dish.
Pot Roast, Chuck Roast	MEAT	Return remainder to oven.	Place in a microwave safe dish.
Rib Roast	MEAT	Turn over. Cover warm areas with aluminum foil.	Place in a microwave safe dish.
Rolled Rump Roast	MEAT	Turn over. Cover warm areas with aluminum foil.	Place in a microwave safe dish.
LAMB			
Cubes for Stew	MEAT	Turn over. Cover warm areas with aluminum foil.	Place in a microwave safe dish.
Chops (1 inch thick)	MEAT	Remove thawed portions with fork. Return remainder to oven.	Place in a microwave safe dish.
PORK Chops			
(1/2 inch thick)	MEAT	Separate and rearrange.	Place in a microwave safe dish.
Hot Dogs	MEAT	Separate and rearrange.	Place in a microwave safe dish.
Spareribs Country-style Ribs	MEAT	Turn over. Cover warm areas with aluminum foil.	Place in a microwave safe dish.
Sausage, Links	MEAT	Separate and rearrange.	Place in a microwave safe dish.
Sausage, Bulk	MEAT	Remove thawed portions with fork. Turn over. Return remainder to oven.	Place in a microwave safe dish.
Loin Roast, Boneless	MEAT	Turn over. Cover warm areas with aluminum foil.	Place in a microwave safe dish.

14 OPERATION

AUTO DEFROST TABLE (CONTINUED)

POULTRY SETTINGS

FOOD	SETTING	AT BEEP
CHICKEN Whole (up to 6 lbs) Cut-up	POULTRY	<ul style="list-style-type: none"> • Turn over breast side down. Cover warm areas with aluminum foil. • Separate pieces and rearrange. • Turn over. Cover warm areas with aluminum foil.
CORNISH HENS Whole	POULTRY	<ul style="list-style-type: none"> • Turn over. Cover warm areas with aluminum foil.
TURKEY Breast (up to 6 lbs)	POULTRY	<ul style="list-style-type: none"> • Turn over. Cover warm areas with aluminum foil.

FISH SETTINGS

FOOD	SETTING	AT BEEP
FISH Fillets	FISH	<ul style="list-style-type: none"> • Turn over. Separate fillets when partially thawed, if possible.
Steaks	FISH	<ul style="list-style-type: none"> • Separate and rearrange.
Whole	FISH	<ul style="list-style-type: none"> • Turn over.
SHELLFISH Crab meat	FISH	<ul style="list-style-type: none"> • Break apart. Turn over.
Lobster tails	FISH	<ul style="list-style-type: none"> • Turn over and rearrange.
Shrimp	FISH	<ul style="list-style-type: none"> • Separate and rearrange.
Scallops	FISH	<ul style="list-style-type: none"> • Separate and rearrange.

DEFROSTING TIPS

- When using Auto Defrost, the weight to be entered is the net weight (the weight of the food minus the container).
- Before starting, make sure to remove any and all metal twist-ties that often come with frozen food bags, and replace them with strings or elastic bands.

- Open containers, such as cartons, before placing in the oven.
- Always slit or pierce plastic pouches or packaging.
- If food is foil wrapped, remove foil and place food in a suitable container.
- Slit the skin of skinned food, such as sausage.
- Bend plastic pouches of food to ensure even defrosting.
- Always under estimate defrosting time. If defrosted food is still icy in the center, return it to the microwave oven for more defrosting.
- The length of defrosting time varies according to how solidly the food is frozen.
- The shape of the package affects how quickly food will defrost. Shallow packages will defrost more quickly than a deep block.
- As food begins to defrost, separate the pieces. Separated pieces defrost more easily.
- Use small pieces of aluminum foil to shield parts of food such as chicken wings, leg tips, fish tails, or areas that start to get warm. Make sure the foil does not touch the sides, top, or bottom of the oven. The foil can damage the oven lining.
- For better results, let food stand after defrosting. (For more information on standing time, see the "Microwave Cooking Tips" section).
- Turn over food during defrosting or standing time. Break apart and remove food as required.

SETTING POPCORN

The Popcorn quick touch pad lets you pop 3.3, 3.0, 1.75 ounce bags of commercially packaged microwave popcorn. Pop only one package at a time. If you are using a microwave popcorn popper, follow manufacturer's instructions.

- **Suppose you want to pop a 3.3 oz. popcorn**

Touch:	Display Shows:
--------	----------------

1. POPCORN

3.3

2. **START**
+30 Sec

POPCORN

Then time will count down

Key press	Selection	Amount
Popcorn	3.3	3.3 oz (94g)
Popcorn	3.0	3.0 oz (85g)
Popcorn	1.75	1.75 oz (50g)

SETTING BEVERAGE

- Suppose you want to reheat 1 cup beverage

Touch:	Display Shows:
1. BEVERAGE	1 CUP
2. START +30 Sec	BEVERAGE

Then time will count down

Key press	Selection
Beverage	1 Cup
Beverage	2 Cup

SETTING VEGGIES

The Veggies quick touch pad lets you cook fresh and frozen vegetables.

- Suppose you want to cook frozen veggies.

Touch:	Display Shows:
1. VEGGIES	FRESH VEGGIES
2. VEGGIES	FROZEN VEGGIES
3. START +30 Sec	FROZEN VEGGIES

Then time will count down

Key	Food
Veggies x1	Fresh Veggies
Veggies x2	Frozen Veggies

Touch Veggie key repeatedly to switch between Fresh and Frozen selections.

SETTING MELT/SOFTEN

The oven uses low power to melt and soften items. See the following table.

- Suppose you want to melt 4 oz. of Chocolate.

Touch:	Display Shows:
1. MELT/ SOFTEN	MELT BUTTER
2. MELT/ SOFTEN	MELT CHOCOLATE
3. START +30 Sec	ENTER 2-4-8
4. (4)	4
5. START +30 Sec	MELT CHOCOLATE

Then time will count down

Key	Food	Amount	Key
Melt / Soften x1	Melt Butter	1 stick	1
		2 sticks	2
Melt / Soften x2	Melt Chocolate	2 oz.	2
		4 oz.	4
		8 oz.	8

16 OPERATION

Melt / Soften x3	Soften Ice Cream	1 Pint	1
		1.5 Quart	2
Melt / Soften x4	Soften Cream Cheese	3 oz.	3
		8 oz.	8

MELT/SOFTEN TABLE

CATEGORY	DIRECTION	AMOUNT
BUTTER	Unwrap and place in microwavable container. No need to cover butter. Stir at the end of cooking to complete melting.	1 or 2 sticks
CHOCOLATE	Chocolate chips or squares of baking chocolate may be used. Unwrap squares and place in microwavable container. Stir at the end of cycle to complete melting.	2, 4 or 8 oz.
ICE CREAM	Place container in oven. Ice cream will be soft enough to make scooping easier.	1 Pint, 1.5 Quart.
CREAM CHEESE	Unwrap and place in microwavable container. Cream cheese will be at room temperature and ready for use in recipe.	3 or 8 oz.

SENSOR OPERATING INSTRUCTIONS

SENSOR OPERATING INSTRUCTIONS

Sensor Cook allows you to cook most of your favorite foods without selecting cooking times and power levels. The display will indicate Sensing during the initial sensing period.

The oven automatically determines required cooking time for each food item. When the internal sensor detects a certain amount of humidity coming from the food, it will tell the oven how much longer to heat. The display will show the remaining heating time. For best results for cooking by Sensor, follow these recommendations.

1. Food cooked with the sensor system should be at normal storage temperature.
2. Always use microwavable containers.
3. Match the amount to the size of the container. Fill containers at least half full for best results.
4. Be sure the outside of the cooking container and the inside of the microwave oven are dry before placing food in the oven. Beads of moisture turning into steam can mislead the sensor.
5. Foods should always be covered with microwavable plastic wrap, waxed paper, or a lid. Never use tight-sealing plastic covers. They can prevent steam from escaping and cause food to overcook.
6. Do not open the door or touch the STOP key during the sensing time. When sensing time is over, the oven beeps and the remaining cooking time will appear in the display window. At this time you can open the door to stir, turn, or rearrange the food.

USING SENSOR COOK

Using SENSOR COOK lets you cook common microwave-prepared foods without needing to program times and cook powers.

- **Suppose you want to cook frozen pizza with sensor.**

Touch:	Display Shows:
1. SENSOR COOK	BACON
2. SENSOR COOK	FROZEN DINNER
3. SENSOR COOK	RICE

- | | | |
|----|-------------------------|---------------------|
| 4. | SENSOR
COOK | FROZEN
BREAKFAST |
| 5. | SENSOR
COOK | FROZEN
PIZZA |
| 6. | START
+30 Sec | FROZEN
PIZZA |

Sensor Cook selections are made by touching the Sensor Cook key multiple times.

USING SENSOR REHEAT

Using SENSOR REHEAT lets you reheat common microwave-prepared foods without selecting cooking times and power levels.

- **Suppose you want to reheat rolls.**

Touch:	Display Shows:
1. SENSOR REHEAT	DINNER PLATE
2. SENSOR REHEAT	SOUP SAUCE
3. SENSOR REHEAT	CASSERO LE
4. SENSOR REHEAT	ROLLS
5. START +30 Sec	ROLLS

Sensor Reheat selections are made by touching the Sensor Reheat key multiple times.

SENSOR COOK TABLE

CATEGORY	DIRECTION	AMOUNT
Bacon	Place bacon strips on a microwave bacon rack for best results. (Use dinner plate lined with paper towels if rack is not available).	1-3 slices
Frozen Dinner	Place in an appropriately sized microwave container. Cover with plastic wrap. After cooking, stir and allow to stand for 3 minutes.	10 oz./ 20 oz.
Rice	Place rice and twice as much liquid (water, chicken or vegetable stock) in a 2 quart microwave dish. Cover with plastic wrap and vent. After cooking, allow to stand for 10 minutes. Stir for fluffier rice.	1-2 cups Use medium or long grain rice. Cook instant rice according to directions on the package.
Frozen Breakfast	Place in a appropriately sized microwave container. Cover with plastic wrap. After cooking, stir and allow to stand for 3 minutes.	8-12 oz.
Frozen Pizza	Remove from package. Place on an appropriately sized microwavable plate. For prepackaged microwavable pizza follow the instructions on the package.	8-12 oz.

18 OPERATION

SENSOR TABLE

CATEGORY	DIRECTION	AMOUNT
Dinner Plate	Place on a low plate. Cover with vented plastic wrap. Let stand 3 minutes after cooking.	1-2 plate
Soup/Sauce	Place in shallow microwavable casserole. Cover with vented plastic wrap. After cooking, stir and let stand 3 minutes.	1 cup
Casserole/Lasagna	Place in a microwavable bowl or casserole. Cover with vented plastic wrap. After cooking, stir and let stand 3 minutes.	10.5 Oz
Roll/Fish		1-3 pieces

USER REFERENCE

This section gives instructions for operating each function. Please read this section carefully.

USER PREF

The microwave oven has settings that allow you to customize the operation for your convenience. Below is the table showing the various settings. Touch the User Pref key multiple times to scroll to the desired setting function.

Key press	Option
User Pref x 1	Volume Low/Med./High/Off
User Pref x 2	Turntable on/off
User Pref x 3	Weight lb/kg

User Pref x 4	Language En/Fr
User Pref x 5	Clock Display Off/On
User Pref x 6	Demo Mode

SETTING VOLUME LOW/MED/HIGH/OFF

- Suppose you want to turn off the Volume.

Touch:

Display Shows:

-  X1

PRESS AGAIN FOR OPTIONS/ PRESS START

VOLUME LOW

PRESS AGAIN FOR OPTIONS/ PRESS START

VOLUME MED

PRESS AGAIN FOR OPTIONS/ PRESS START

VOLUME HIGH

PRESS AGAIN FOR OPTIONS/ PRESS START

VOLUME OFF
- START**

+30 Sec

OFF

SETTING TURNTABLE ON/OFF

- Suppose you want to turn on the Turntable.

Touch:

Display Shows:

-  X2

PRESS AGAIN FOR OPTIONS/ PRESS START

TURN TABLE ON
- START**

+30 Sec

TT ON

SETTING WEIGHT Lb/KG

- Suppose you want to toggle weight between pounds & kilograms.

Touch:

Display Shows:

-  X3

PRESS AGAIN FOR OPTIONS/ PRESS START

Lb / Kg
- START**

+30 Sec

Kg

SETTING LANGUAGE

- If the language is English:

Touch:	Display Shows:
1.  X4	<small>PRESS AGAIN FOR OPTIONS/ PRESS START</small> LANGUAGE FRENCH
2. START +30 Sec	FRANCAIS

SETTING CLOCK DISPLAY OFF/ON

- If the clock display is on:

Touch:	Display Shows:
1.  X5	<small>PRESS AGAIN FOR OPTIONS/ PRESS START</small> CLOCK DISPLAY ON
2. START +30 Sec	OFF



SETTING DEMO

- If the language is English:

Touch:	Display Shows:
1.  X6	<small>PRESS AGAIN FOR OPTIONS/ PRESS START</small> DEMO OFF
2. START +30 Sec	ON

USING VENT FAN

- Suppose you want to set the vent fan speed to HIGH from the OFF position.

Touch:	Display Shows:
1. 	HIGH
2. 	LOW
3. 	OFF

Turn off fan when desired



NOTE

If the temperature from the range or cooktop below the oven gets too hot, the vent fan will automatically turn on to protect the oven. It may stay on up to an hour to cool the oven. When this occurs, the Vent pad will not turn the fan off.

USING COOKTOP LIGHT

The pad controls the cooktop light. If the light is OFF the first touch of the light pad will turn the light HIGH, second touch LOW and third touch OFF.

- Suppose you want to set the light for HIGH from the OFF position.

Touch:	Display Shows:
1. 	HIGH
2. 	LOW
3. 	OFF

20 MAINTENANCE

Troubleshooting

Check your problem by using the chart below and try the solutions for each problem. If the microwave oven still does not work properly, contact the nearest authorized service center.

TROUBLE	POSSIBLE CAUSE	POSSIBLE REMEDY
Oven will not start	<ul style="list-style-type: none">• Electrical cord for oven is not plugged in.• Door is open.• Wrong operation is set.	<ul style="list-style-type: none">• Plug into the outlet.• Close the door and try again.• Check instructions.
Arcing or sparking	<ul style="list-style-type: none">• Materials to be avoided in microwave oven were used.• The oven is operated when empty.• Spilled food remains in the cavity.	<ul style="list-style-type: none">• Use microwave-safe cookware only.• Do not operate with oven empty.• Clean cavity with wet towel.
Unevenly cooked foods	<ul style="list-style-type: none">• Materials to be avoided in microwave oven were used.• Food is not defrosted completely.• Cooking time, power level is not suitable.• Food is not turned or stirred.	<ul style="list-style-type: none">• Use microwave-safe cookware only.• Completely defrost food.• Use correct cooking time, power level.• Turn or stir food.
Overcooked foods	<ul style="list-style-type: none">• Cooking time, power level is not suitable.	<ul style="list-style-type: none">• Use correct cooking time, power level.
Undercooked foods	<ul style="list-style-type: none">• Materials to be avoided in microwave oven were used.• Food is not defrosted completely.• Oven ventilation ports are restricted.• Cooking time, power level is not suitable.	<ul style="list-style-type: none">• Use microwave-safe cookware only.• Completely defrost food.• Check to see that oven ventilation ports are not restricted.• Use correct cooking time, power level.
Improper defrosting	<ul style="list-style-type: none">• Materials to be avoided in microwave oven were used.• Cooking time, power level is not suitable.• Food is not turned or stirred.	<ul style="list-style-type: none">• Use microwave-safe cookware only.• Use correct cooking time, power level.• Turn or stir food.

Disconnect the power cord or leave the door open to deactivate the oven during cleaning. Disconnect the power cord before replacing filters and lights.

EXTERIOR

The outside surface is precoated steel and plastic. Clean the outside with mild soap and water; rinse and dry with a soft cloth. Do not use any type of household or abrasive cleaner.

DOOR

Wipe the window on both sides with a soft cloth to remove any spills or splatters. Metal parts will be easier to maintain if wiped frequently with a soft cloth. Avoid the use of spray and other harsh cleaners as they may stain, streak or dull the door surface.

EASY CARE™ STAINLESS STEEL (SOME MODELS)

Your microwave oven finish may be made with Easy Care™ Stainless Steel (some models). Clean the stainless with warm soapy water using a clean sponge or cloth. Rinse with clean water and dry with a soft clean cloth. DO NOT use ANY store bought cleaners like Stainless Steel cleaners or any other types of cleaners containing any abrasive, chlorides, chlorines or ammonia. It is recommended to use mild dish soap and water or a 50/50 solution of water and vinegar.

INTERIOR

Cleaning is easy because little heat is generated to the interior surfaces; therefore, there is no baking and setting of spills or spattering. To clean the interior surfaces, wipe with a soft cloth and warm water. DO NOT USE ABRASIVE OR HARSH CLEANERS OR SCOURING PADS. For heavier soil, use baking soda or a mild soap; rinse thoroughly with hot water. The rack can be cleaned with hot soapy water, rinsed and dried.

WAVEGUIDE COVER

The waveguide cover is located on the ceiling in the microwave oven cavity. It is made from mica so requires special care. Keep the waveguide cover clean to assure good microwave oven performance. Carefully wipe with a damp cloth any food splatters from the surface of the cover immediately after they occur. Built-up splashes may overheat and cause smoke or possibly catch fire. DO NOT REMOVE THE WAVEGUIDE COVER.

ODOR REMOVAL

Occasionally, a cooking odor may remain in the microwave oven. To remove, combine 1 cup water, grated peel and juice of 1 lemon and several whole cloves in a 2-cup glass measuring cup. Boil for several minutes using 100% power. Allow to set in microwave oven until cool. Wipe interior with a soft cloth.

TURNTABLE/TURNTABLE SUPPORT

The turntable and turntable support can be removed for easy cleaning. Wash them in mild, sudsy water; for stubborn stains use a mild cleanser and non-abrasive scouring sponge. They are also dishwasher-proof. Use upper rack of dishwasher. The turntable motor shaft is not sealed, so excess water or spills should be wiped up immediately.

GREASE FILTER

Filter should be cleaned at least once a month. Never operate the fan or microwave oven without the filter in place.

1. Pull down slightly on the tab toward the front of the microwave oven and remove the filter.
2. Soak the filter in a sink or dish pan filled with hot water and detergent. DO NOT use ammonia or other alkali; they will react with the filter material and darken it.
3. Agitate and scrub with a brush to remove embedded dirt.
4. Rinse thoroughly and shake dry.
5. Replace by fitting the filter back into the opening.

BOTTOM VIEW

(Front of microwave oven)

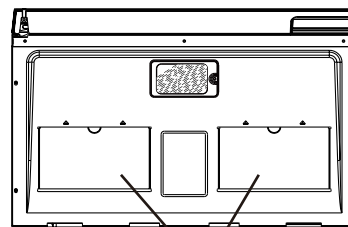

(Rear of microwave oven)

Grease filter

22 CLEANING AND CARE

Disconnect the power cord or leave the door open to deactivate the oven during cleaning. Disconnect the power cord before replacing filters and lights.

CLEANING THE EXHAUST FILTERS

The oven ventilation exhaust filters should be removed and cleaned often; generally at least once every month.

Vent exhaust filter part number 5304478913
To order parts call 800-599-7569

⚠ CAUTION

To avoid risk of personal injury or property damage, do not operate oven hood without filters properly in place.

BOTTOM VIEW (Front of microwave oven)

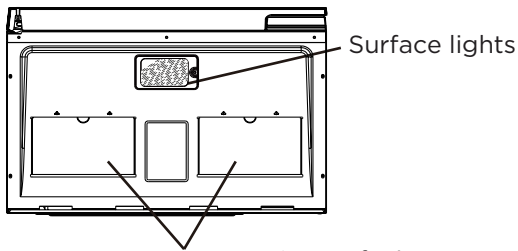

(Rear of microwave oven)
 Grease filter

- To remove the exhaust ventilation filters, slide the filter to the rear. Then pull filter downward and push to the other side. The filter will drop out.

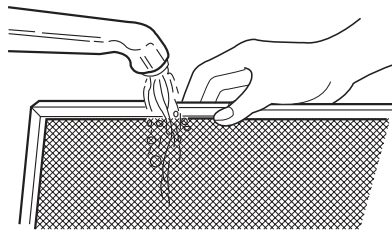

- Soak the ventilation filters in hot water using a mild detergent. Rinse well and shake to dry or wash in a dishwasher. Do not use ammonia. The aluminum on the filter will corrode and darken.

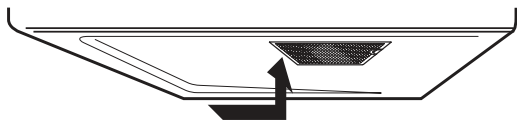

- To reinstall the exhaust ventilation filter, slide it into the side slot, then push up and toward oven to lock. Reinstall the 2nd filter using the same procedure.

SURFACE LIGHT REPLACEMENT

⚠ CAUTION

To avoid risk of personal injury or property damage, wear gloves when replacing the light bulbs.

- Unplug the microwave oven or turn off power at the main circuit breaker.
- Remove the LED light cover mounting screws at both light positions under the microwave.

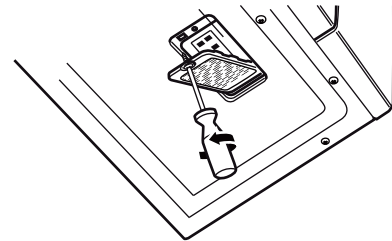

- Remove the LED light mounting screw.

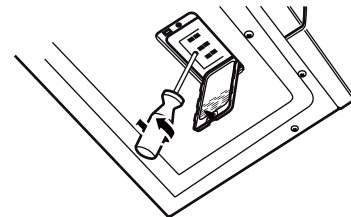

- Unplug the LED light from the harness, replace with LED light of part# 5304499540. To order parts call 800-599-7569. Then reconnect the harness.

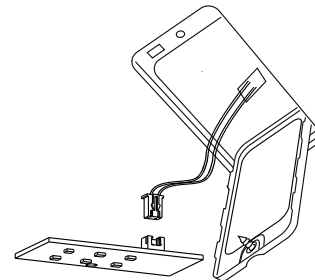

- Re-install LED light and mounting screw. When re-installing mounting screw be careful not to damage the LED light.
- Re-install LED light cover and mounting screw.
- Plug the microwave back into the power supply or turn the power back on at the main circuit breaker.

Disconnect the power cord or leave the door open to deactivate the oven during cleaning. Disconnect the power cord before replacing filters and lights.

CHARCOAL FILTER REPLACEMENT

Charcoal Filter installed in your microwave oven, is used for non vented, recirculated installation. The filter should be changed every 6 to 12 months depending on use.

- Disconnect power to the microwave oven at the circuit breaker panel or by unplugging.
- Remove the vent grill mounting screws.
- Pull the vent grill away from the unit.

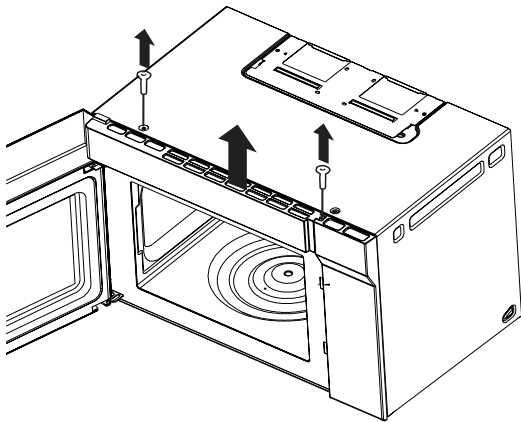

- Remove the charcoal filter and replace with part number.

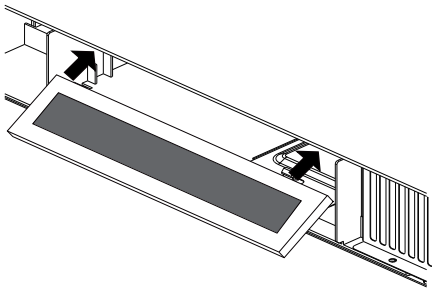

- Put the vent grill back on unit.

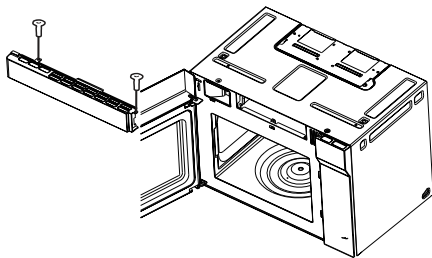

OVEN LIGHT REPLACEMENT

Remove the vent grill per charcoal filter replacement instructions.

- Remove the light cover mounting screw, open light cover by carefully pulling up on the front edge.

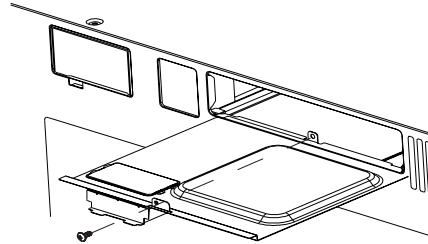

- Remove the LED bracket and light assembly. Remove the LED light from the bracket by removing the mounting screw and replace only with part 5304499540. To order parts call 800-599-7569.

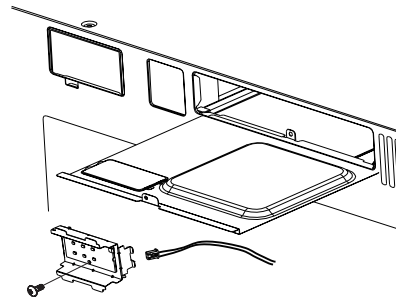

- Re-install LED light to the bracket with mounting screw. When re-installing mounting screw be careful not to damage the LED light.
- Reconnect LED light to the harness and place the LED light assembly back into the light cover.

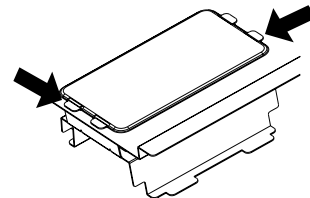

- Replace the microwave oven light cover by carefully pushing into place and mounting the screw.
- Put the vent grill back on unit.

24 SERVICE CALL CHECK

Please check the following before calling for service:

Place one cup of water in a glass measuring cup in the microwave oven and close the door securely. Operate the microwave oven for one minute at HIGH 100%.

- | | |
|--|------------------|
| A Does the microwave oven light come on? | YES ____ NO ____ |
| B Does the cooling fan work? (Put your hand at top above Display) | YES ____ NO ____ |
| C Does the turntable rotate? (It is normal for the turntable to turn in either direction.) | YES ____ NO ____ |
| D Is the water in the microwave oven warm? | YES ____ NO ____ |

If “NO” is the answer to any of the above questions, please check electrical outlet, fuse and/or circuit breaker. If they are functioning properly, CONTACT YOUR NEAREST ELECTROLUX AUTHORIZED SER-VICER.

A microwave oven should never be serviced by a “do-it-yourself” repair person.



NOTE

1. If time appearing in the display is counting down very rapidly, check Demonstration Mode in the CONVENIENT FEATURES section to make sure DEMO Mode is OFF.
2. If the oven is set for more than 30 minutes at, 100 percent power level, after the first 30 minutes the power level will automatically adjust itself to 80 percent power to avoid overcooking.

SPECIFICATIONS

AC Line Voltage:	Single phase 120V, 60Hz, AC only
AC Power Required:	1500 W 13.5 A (for UMV1422US,UMV1422UW)
Output Power*:	1000 W
Frequency:	2450 MHz (Class B/Group2)**
Outside Dimensions (including handle):	23 55/64(W) X 16 21/32(H) X 16 3/16(D) inch
Cavity Dimensions:	15 25/64(W) X 10 45/64(H) X 15 9/32(D) inch
Microwave oven Capacity***:	1.4 Cu.Ft.
Cooking Uniformity:	Turntable
Weight:	Approx, (net) 52.76lbs, (gross) 61.42lbs
Work/Night Light:	1*1.2WLED
Oven Light:	1*1.2WLED

* The International Electrotechnical Commission’s standardized method for measuring output wattage. method is widely recognized. test method

** This is the classification of ISM (Industrial, Scientific and Medical) equipment described in the International Standard CISPR11.

*** Internal capacity is calculated by measuring maximum width, depth and height. Actual capacity for holding food is less. In compliance with standards set by:

FCC - Federal Communications Commission Authorized.

DHHS - Complies with Department of Health and Human Services (DHHS) rule, CFR, Title 21, Chapter I, Subchapter J.



- This symbol on the nameplate means the product is listed by Underwriters Laboratories, Inc.



- This symbol on the nameplate means the product is listed by Underwriters Laboratories, Inc. for use in USA or Canada.

Your appliance is covered by a one year limited warranty. For one year from your original date of purchase, Electrolux will pay all costs for repairing or replacing any parts of this appliance that prove to be defective in materials or workmanship when such appliance is installed, used and maintained in accordance with the provided instructions.

Exclusions

This warranty does not cover the following:

1. Products with original serial numbers that have been removed, altered or cannot be readily determined.
2. Product that has been transferred from its original owner to another party or removed outside the USA or Canada.
3. Rust on the interior or exterior of the unit.
4. Products purchased "as-is" are not covered by this warranty.
5. Food loss due to any refrigerator or freezer failures.
6. Products used in a commercial setting.
7. Service calls which do not involve malfunction or defects in materials or workmanship, or for appliances not in ordinary household use or used other than in accordance with the provided instructions.
8. Service calls to correct the installation of your appliance or to instruct you how to use your appliance.
9. Expenses for making the appliance accessible for servicing, such as removal of trim, cupboards, shelves, etc., which are not a part of the appliance when it is shipped from the factory.
10. Service calls to repair or replace appliance light bulbs, air filters, water filters, other consumables, or knobs, handles, or other cosmetic parts.
11. Surcharges including, but not limited to, any after hour, weekend, or holiday service calls, tolls, ferry trip charges, or mileage expense for service calls to remote areas, including the state of Alaska.
12. Damages to the finish of appliance or home incurred during installation, including but not limited to floors, cabinets, walls, etc.
13. Damages caused by: services performed by unauthorized service companies; use of parts other than genuine Electrolux parts or parts obtained from persons other than authorized service companies; or external causes such as abuse, misuse, inadequate power supply, accidents, fires, or acts of God.

DISCLAIMER OF IMPLIED WARRANTIES; LIMITATION OF REMEDIES

CUSTOMER'S SOLE AND EXCLUSIVE REMEDY UNDER THIS LIMITED WARRANTY SHALL BE PRODUCT REPAIR OR REPLACEMENT AS PROVIDED HEREIN. CLAIMS BASED ON IMPLIED WARRANTIES, INCLUDING WARRANTIES OF MERCHANTABILITY OR FITNESS FOR A PARTICULAR PURPOSE, ARE LIMITED TO ONE YEAR OR THE SHORTEST PERIOD ALLOWED BY LAW, BUT NOT LESS THAN ONE YEAR. ELECTROLUX SHALL NOT BE LIABLE FOR CONSEQUENTIAL OR INCIDENTAL DAMAGES SUCH AS PROPERTY DAMAGE AND INCIDENTAL EXPENSES RESULTING FROM ANY BREACH OF THIS WRITTEN LIMITED WARRANTY OR ANY IMPLIED WARRANTY. SOME STATES AND PROVINCES DO NOT ALLOW THE EXCLUSION OR LIMITATION OF INCIDENTAL OR CONSEQUENTIAL DAMAGES, OR LIMITATIONS ON THE DURATION OF IMPLIED WARRANTIES, SO THESE LIMITATIONS OR EXCLUSIONS MAY NOT APPLY TO YOU. THIS WRITTEN WARRANTY GIVES YOU SPECIFIC LEGAL RIGHTS. YOU MAY ALSO HAVE OTHER RIGHTS THAT VARY FROM STATE TO STATE.

If You Need Service

Keep your receipt, delivery slip, or some other appropriate payment record to establish the warranty period should service be required. If service is performed, it is in your best interest to obtain and keep all receipts. Service under this warranty must be obtained by contacting Electrolux at the addresses or phone numbers below.

This warranty only applies in the USA and Canada. In the USA, your appliance is warranted by Electrolux Major Appliances North America, a division of Electrolux Home Products, Inc. In Canada, your appliance is warranted by Electrolux Canada Corp. Electrolux authorizes no person to change or add to any obligations under this warranty. Obligations for service and parts under this warranty must be performed by Electrolux or an authorized service company. Product features or specifications as described or illustrated are subject to change without notice.

USA

1-800-374-4432

Electrolux Home Products,
Inc., 10200 David Taylor
Drive Charlotte, NC 28262



Electrolux

Canada

1.800.265.8352

Electrolux Canada Corp.
5855 Terry Fox Way
Mississauga, Ontario, Canada
L5V 3E4

Printed in China

FRIGIDAIRE®

welcome *home*

Our home is your home. Visit us if you need help with any of these things:



owner support



accessories



service



registration

(See your registration card for more information.)

Frigidaire.com
1-800-374-4432

Frigidaire.ca
1-800-265-8352